



# **SURANA COLLEGE** **(AUTONOMOUS)**

**2021-22**  
**AQAR**

**Annual Quality Assurance Report**

## **Criterion 3**

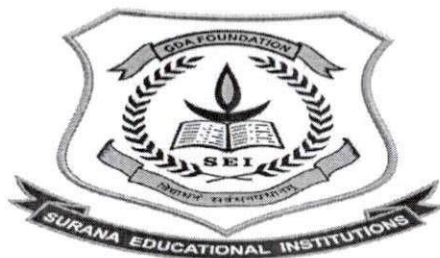
**Metric No. 3.4.4 QnM**

Number of Books and Chapters in edited volumes/books  
published per teacher during the year



**3.4.4 List of e copies of Books and Proceedings with cover page,content pageand First page of the publication**





# Surana College

AUTONOMOUS

16, South End Road | Bengaluru-04

Reaccredited 'A+' Grade by NAAC | Affiliated to Bengaluru University

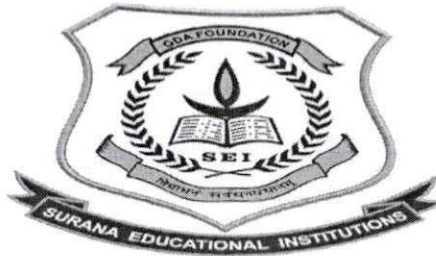
3.4.4

e-copy of the Cover page, content page and first page of the publication indicating ISBN number and year of publication for books/chapters and conference proceedings

## Index

SL. No.	Name of the Teacher	Title of the Book published	Title of the Chapter published	Title of the proceedings of the conference	Page No.
1.	Dr. Farzana Tasneem MR		Production of Indoor Plants- Bringing nature to home Horticulture	Nil	1 - 101
2.	Dr. Farzana Tasneem MR	Phytocine 2022	Phytomedicinal Constituents in Terminalia catappa varieties, an Indian Almond	Centre for molecular and Computational Biology	
3.	Dr. Farzana Tasneem MR	Parasitic Fungal Diseases, Research in Mycology, Vol 1	Nil	Nil	

*Bhauzyl*  
Principal  
Surana College  
(AUTONOMOUS)  
No. 16, South End Road,  
Bangalore - 560 004.



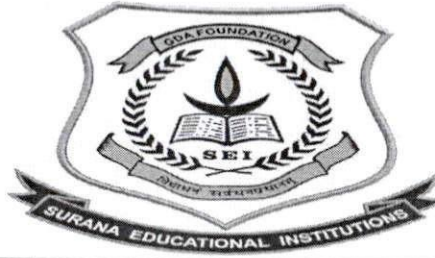
# Surana College

## AUTONOMOUS

16, South End Road | Bengaluru-04  
Reaccredited 'A+' Grade by NAAC | Affiliated to Bengaluru University

4.	Simran Parveen	Women's Education in India	Women's education: challenges in 21st century	Nil	102 - 105
5.	Kiran Anandan	Asian Journal of Organic & Medicinal chemistry	An Empirical Study on Factors Influencing Consumer Adoption of Cashless Payment in Bengaluru	Nil	106 - 824
6.	Sri Harsha	Financial Accountancy	Nil	Nil	825 - 828
7.	Sri Harsha	Principles of Marketing	Nil	Nil	
8.	Sri Harsha	Advanced Financial Accountancy	Nil	Nil	
9.	Sri Harsha	Banking Innovation	Nil	Nil	
10.	Prof Savita Shastri	N.A.	Technology - Tourism Interface: An Emerging Trend	N.A.	829 - 836
11.	Prof Savita Shastri	N.A.	Employee Perception and Coping Mechanism to ward off rising stress levels in Remote Working	N.A.	837 - 850

*Bhanez M*  
Principal  
Surana College  
(AUTONOMOUS)  
No. 16, South End Road,  
Bangalore - 560 004.



# Surana College

## AUTONOMOUS

16, South End Road | Bengaluru-04  
Reaccredited 'A+' Grade by NAAC | Affiliated to Bengaluru University

12.	Mr. Gururaj F D	N.A.	Challenges of LIS Professionals as a Facilitators Of Information Resources In Social Networking Sites	N.A.	851 - 854
13.	Mr. Gururaj F D	N.A.	Fifty Years (1970-2019) Journey of 'Journal of Documentation': A Scient metric Analysis of Research Productivity and Publication	N.A.	855 - 879
14.	Dr Tirumal	Nil	Veda-Puraana- Mahaakaavyaadishu Bhaaratiyasamskritehe Chitranam	Aurobindo College	880 - 885
15.	Dr Tirumal		Laghukriyapada Sangraha	Nil	886 - 890
16.	Dr Tirumal	Nil	Sanskritasaahitye Dharmaha Sanskritishcaha	Kavikulaguru Kalidas Sanskrit University, Ramtek	891 - 894
17.	Padmaja	Nil	Guru Shishya Tradition - A part of ancient culture in Mahabratha perceptive	Shri Aurobindo college Rajajinagar	898 - 900

*Bhaveri MH*

Principal  
Surana College  
(AUTONOMOUS)  
No. 16, South End Road,  
Bangalore - 560 004.



# Surana College

## AUTONOMOUS

16, South End Road | Bengaluru-04  
Reaccredited 'A+' Grade by NAAC | Affiliated to Bengaluru University

18.	Padmaja	Nil	Dharmastra and culture	Kavikalaguru Kalidas Sanskrith University. Rantak, Maharastra.	901 - 907
19.	Prof. Aparna Mathapathi	Advanced Corporate Accounting	Nil	Nil	911 - 917
20.	Dr. B G Lakshmi	Financial Accounting and Reporting	Nil	Nil	918 - 939
21.	Prof. Mini K Abraham	Financial Accountancy	Nil	Nil	940 - 952
22.	Srinivas Rao	Digital fluency	Digital fluency	Nil	953 - 958

*Bhauzyl*  
Principal  
Surana College  
(AUTONOMOUS)  
No. 16, South End Road,  
Bangalore - 560 004.



# Pharmaceutical Phyto-Medicine



## Poster Presentation: Prize Winners

### **Best Poster Presentation in “Pharmaceutical Phyto-Medicine” Theme**

**Mr Madhan kumar**

*Sri Ramachandra Institute of Higher Education and Research, Chennai,  
Tamil Nadu*

“Modelling Intracerebral Haemorrhage in Adult Zebrafish to Study  
Neuromodulatory Effects of Asiaticoside”

**Ms. Varsha Rani**

*REVA University, Bengaluru, Karnataka*

“Behavioural Analysis of *Drosophila melanogaster* to Different Stress Models and  
Identification of Neuroprotective Compounds in Selected Plants”

### **Best Poster Presentation in “Bioinformatics Approach to Phyto-Medicine”**

**Ms Shatakshi Mishra**

*St. Joseph's College (Autonomous) Bengaluru, Karnataka*

“Selection Of Phytochemicals From *Calendula Officinalis*: Potent Inhibitor Of  
*Streptococcus iniae*”

## Scientific Events : Prize Winners

**Debate:**

**Ms. Tunga PR**

*Mount Carmel College, Bengaluru, Karnataka*

**Quiz:**

**Mr Ganesh V**

*St. Joseph's College (Autonomous) Bengaluru, Karnataka*





# Abstracts



## Phytomedicinal Constituents in *Terminalia catappa* varieties, an Indian Almond

Farzana Tasneem MI  
Dr. Asma Saqib

Department of Biotechnology, Surana  
College (Autonomous), Bangalore-04.

### Abstract:

*Terminalia catappa* is an ornamental tropical tree belonging to the family Combretaceae is native to Southeast Asia in the tropical regions of Asia, Africa, and Australia commonly called Indian Almond. In our study, we have taken varieties of *Terminalia catappa* plant extract and conducted GCMS Study. The *Terminalia catappa* T1Y and T2R varieties were subjected to GCMS analysis and chromatogram percentages with peak area are observed. The result of phytocompounds as GCMS analysis of *Terminalia catappa* in methanol extract of T1Y variety showed 13 peaks. The T1Y variety identified compounds shows the highest peak areas, Ethylsilatrane (39.4 RT), Methyl 10-octadecenoate (38.75), 7,9-Di-tert-butyl-1-oxaspiro (4,5) deca-6,9-diene-2,8dione (35.39) Terephthalic acid, 2-methoxybenzyl pentyl ester (35.04) and lowest peak areas are Isocapro lactone (7.53,7.64) Analgesic and retinoic compound. 2,3-Dimethyl-3-buten-2-ol (7.97), Allyl heptanoate (8.23), Crotylhydrazine (8.29),  $\alpha$ -Ketocaprylic acid (8.58), 3,4-Dimethyl-5-isoxazolol (8.66), and moderate peak area for N-Methylimidazole (18.28), T1 Yellow variety peak area percentage showed highest for 2,3-Dimethyl-3-buten-2-ol (24.75) and the lowest for 3,4-Dimethyl-5-isoxazolol (3.3). The compounds present in the T1 variety like Ethylsilatrane (39.4 RT) and Methyl 10-Octadecenoate (38.75) are used in Industrial application and Downstream production. The product by showing the highest peak area 2,3-Dimethyl-3-buten-2-ol (24.75) and Allyl heptanoate with (18.78) are used as pharmacokinetics (Food additives) and Food grade and Flavor agent T2R variety showed 9 peaks, highest peak area was benzothiazole, 2-(2-hydroxyethylthio) (35.7), lowest peak area was Isocapro lactone (7.5) and other compounds are  $\delta$ -Hydroxyvaleramide (7.61), N-Butyryl-L-homoserine lactone (7.95), Crotylhydrazine (8.29), Allyl heptanoate (8.51),  $\alpha$ -Ketocaprylic acid (8.58) and 3,4-Dimethyl-5-isoxazolol (8.66). The percentage of peak area is Butyryl-L-homoserine lactone (25.69) and the lowest is 3,4-Dimethyl-5-isoxazolol (2.72). In the T2 R variety the highest peak area chemical compounds-Butyryl-L-homoserine lactone (7.95) and Allyl heptanoate (8.51) were used in the formation of biofilm and Aroma chemicals, Benzothiazole, 2-(2-hydroxyethylthio) which is used as an antioxidant was also observed. many compounds are yet to discover as a future line of work.



# CERTIFICATE OF PUBLICATION

THIS CERTIFICATE IS PRESENTED TO

**Dr. Farzana Tasneem Mi1**

*For publishing his/her chapter "Production Of Indoor Plants " in the edited book "Bringing nature to home-Horticulture" on dated 26 July 2022 with ISBN 978-93-94894-40-2 .*

A handwritten signature in black ink that reads "Ruchita".

EDITOR  
DR. RUCHITA SHRIVASTAVA

A handwritten signature in black ink that reads "Ragini".

EDITOR  
DR. RAGINI SIKARWAR

A handwritten signature in blue ink that reads "Anil".

MANAGING EDITOR  
NITYA PUBLICATIONS, BHOPAL

International Conference on Phytomedicine 2022 "Phytocine'22" is organized by CMCB association of the Department of Botany, in St. Joseph's College (Autonomous) Bengaluru. The main theme of the conference is Biotechnological and Bioinformatics aspects of Phytomedicine. The conference concentrates on research in the field of phytomedicine, phytochemistry and natural products, that also includes Nanotechnology, Endophytic Microbes, Pharmaceutical Applications, Genomics & Proteomics research in the field of Phytomedicine. Phytocine'22 is deliberated to gather experts, faculties, scholars and students, interested in the field of phytomedicine, to share, interact and exchange of knowledge and ideas. Phytocine'22 has collaborated with 'The Society for Conservation and Resource Development of Medicinal Plant' to publish the presented research works in its esteemed 'Medicinal Plants Journal' as a special issue dedicated for the conference presented works.



Lokesh Ravi

# Phytocine'22

Book of Abstracts



Dr Lokesh Ravi an Assistant Professor, in the Department of Botany, St. Joseph's College (Autonomous) Bengaluru, is an active researcher in the field of Drug Discovery, Natural Products, Phytomedicine and Bioinformatics.





**St. Joseph's College (Autonomous)**

#36, Lalbagh Road, Bengaluru - 560027

Recognised as "College of Excellence" by UGC

Re-accredited with A++ Grade and 3.79/4.00 CGPA by NAAC

Awarded the DBT-Star Status & DST-FIST grant by Ministry of Science and Technology, GOI



CMCB

**Department of Botany**  
**Centre for Molecular & Computational Biology**

# Phytocine 2022



*The International Conference on  
Phytomedicine*

**Book of Abstracts**



## Table of Contents

Content	Page No.
About Us	2
Thoughts of the chairman	4
Message to the participants	6
Lead Lectures	8
Organizing committee	10
Sponsors	14
Prize winners	15
<b>Abstracts</b>	
Pharmaceutical Phyto-Medicine	18
Bioinformatics Approach to Phyto-Medicine	60
Phyto-Chemistry in Nanotechnology	78
Natural Products Against Covid	86
Genomics & Proteomics of Phytomedicine	89
Phytocine'22 Schedule	92
Phytocine'22 Report	94



## About Us

### About Phytocine'22

International Conference on Phytomedicine 2022 “Phytocine’22” is organized by CMCB association of the Department of Botany, in St. Joseph’s College (Autonomous) Bengaluru. The main theme of the conference is Biotechnological and Bioinformatics aspects of Phytomedicine. The conference concentrates on research in the field of phytomedicine, phytochemistry and natural products, that also includes Nanotechnology, Endophytic Microbes, Pharmaceutical Applications, Genomics & Proteomics research in the field of Phytomedicine. Phytocine’22 is deliberated to gather experts, faculties, scholars and students, interested in the field of phytomedicine, to share, interact and exchange of knowledge and ideas. Phytocine’22 has collaborated with ‘The Society for Conservation and Resource Development of Medicinal Plant’ to publish the presented research works in its esteemed ‘Medicinal Plants Journal’ as a special issue dedicated for the conference presented works.

### About St. Joseph’s College

St. Joseph’s College is a private, Jesuit, higher educational institution run by the Karnataka Province of the Society of Jesus in Bengaluru, Karnataka, India. It is one of the oldest colleges in the state of Karnataka with a history of 140 years. It has been conferred with the award “College of Excellence” by the University Grants Commission (India). The college was awarded a rating of A<sup>++</sup> (3.79/4.0), in the 4<sup>th</sup> cycle of re-accreditation by the National Assessment and Accreditation Council (NAAC) in 2017. It offers graduate, post-graduate and research degrees. St. Joseph’s College consists of 300 teaching and non-teaching staffs and more than 7800 students in its campus.

### About Botany Department

The Department of Botany is one of the oldest departments present in St. Joseph’s College. Established in 1954, the department has a rich scientific heritage. Headed by towering botanists like Late Rev. Fr. Dr. Cecil Saldanha, SJ, whose achievements have inspired thousands of students and still continues to be the idol and guiding light for our students. The department promotes a culture of scientific quests amongst its students and encourages young minds to explore the various fields of research, deciphering the mysteries of the plant kingdom.



## About Centre for Molecular & Computational Biology

CMCB is an association organized for the benefit of students interested in molecular and computational biology. It aims to inculcate research culture in student's curriculum. It encourages students to participate in research, provides career guidance, and helps students to build skillsets through various scientific workshops and trainings. The association promotes the development, implementation and application of analytical and computational methods to biological sciences.

## About Medicinal Plants Journal

The Society for Conservation and Resource Development of Medicinal Plant, New Delhi, India has been publishing an international journal, i.e. "Medicinal Plants" covering all aspects of Phytomedicine, medicinal crop cultivation, ethnobotany, phytochemistry, pharmacognosy, conservation, resource development, and biotechnology and related industries. This journal is published quarterly and promotes an interdisciplinary exchange of knowledge and ideas. It is a unique endeavor because there is no other journal in the world, which covers all aspects of medicinal plants. The Medicinal Plants is planned with the aim of providing a high-profile vehicle for the publication of innovative and original research results and indexed in UGC Care List, SCOPUS, Elsevier Biobase, CAB and may other international index services





## Thoughts of The Chairman



*Message by Dr. Fr. S. Xavier, SJ*

When the post COVID19 world is progressing towards antibiotics and vaccine development, an effort by the 6<sup>th</sup> Century Monastic Herbal Garden initiatives by the Monks in England has not gone waste, it has spread its tentacles in India, where Indian people have found that herbal remedies are in their hands. The cultivation of herbal garden either on the roof top or on a little courtyard space has become part and parcel of Indian habits. The traditional medicines, where India is promoting into, AYUSH product or Patanjali product are taking its root in the billion-dollar industry of Phytomedicine. I am sure, people who participate in this particular Phytocine'22 will understand the richness and diversity that is present in our Indian herb gardens. This particular endeavor will send people with this confidence that the healing panacea is in their hands. I wish all the best to the organizers and St. Joseph's being a Jesuit Institution, take its lead to bring the phytomedicine aspect into student's curriculum and promote their interest by presentation of papers and posters on phytomedicine.

I am also glad to know that, the outcome of the conference will come out in Medicinal Plants, one of the promising journals on phytomedicine. I wish the organizers all the best. May god bless us all.

**Dr. Fr. S. Xavier, SJ**

Research Director  
St. Joseph's College (Autonomous), Bengaluru



## Thoughts of The Chairman



*Message by Fr. Denzil E. Lobo, SJ*

I am very happy that under the leadership of **Dr Lokesh Ravi** and his team of faculty members and students have organized **Phytocine'22**, the International Conference on Phytomedicine, the theme being Biotechnological and Bioinformatics aspects of phytomedicine.

Phytomedicine is the science of medicines from plants. Aboriginal people in various countries, including our own country, have been using variety of plants as food and medicine to maintain good health. Plants are a rich source of natural compounds whose biological activities have provided medicinal values to traditional healers. With the development of biotechnology, phytochemistry and bioinformatics we are in a better position to study the properties of various plants, and their applications in medicine. Thus through the additive and synergetic action of several chemical compounds, unlike the synthetic pharmaceuticals based upon single chemicals which have adverse effect on human body, we are in a position to make medicines which will have holistic effect.

I congratulate the organizers and wish them all the best. Let this conference generate new ideas and thus enable in advancing knowledge about phytomedicines.

**Fr Denzil Lobo SJ**

Director, St Joseph's Institute of Information Technology  
St Joseph's College (Autonomous), Bengaluru



## Message for Head of Department, Botany



**Dr. Jayarama Reddy**

It is indeed a pride moment as the Centre for Molecular & Computational Biology an association under the Department of Botany at St. Joseph's College (Autonomous) Bengaluru has organized "**Phytocine'22**", The International Conference on Phytomedicine on 20<sup>th</sup> & 21<sup>st</sup> of May 2022.

Phytomedicines are plant-based drugs or herbal medicines with therapeutic and healing properties. They came into existence after the advent of human civilization. But in recent times they have gained immense importance as the global herbal medicine market size was estimated to be US\$ 83 billion in 2019 and is expected to reach US\$ 550 billion by 2030. Hence the topic of this conference is very appropriate and pertinent. I congratulate all the organizers and delegates of Phytocine'22.

**Dr. Jayarama Reddy**

Head of Department,  
Department of Botany,  
St. Joseph's College (Autonomous) Bengaluru



## Message to the participants



### **Dr. Kannabiran Krishnan**

"I am happy to be a part of the International Conference Phytomedicine 2022 "Phytocine'22". The title is very apt one to the present days need, as everyone of us turning our eyes towards Phytomedicines for alleviating human diseases and for our own well-being. I hope the conference will provide ample opportunity to enrich our knowledge and certainly it will help to inculcate the research culture among the youngsters. Thanks to the Management and the Organizers of the conference. I pray for great success of the conference. All the best".

### **Dr Sailendra Singh**

Plants based secondary metabolites production have been customarily serving as a natural reservoir for drug development practice for long decades and are still leading the crucial scaffold in pharmaceutical/cosmeceutical industries. The collective understanding of the role of phytomedicines can impart a worthy global impact for the human welfare. I wish good luck to the organizing team for grand success of the conference "Phytocine 22".



### **Dr Kasi Gopinath**

"Nature' gifted the drug in the form of plants. Various phytoconstituents are produced by the physiological process of plants. Various formulation of drugs has been utilized by the traditional knowledge of world people. They believe in phytomedicine because of the efficient recovery from disease and better biocompatibility, as compared to modern medicine."

### **Dr. Sudhakaran K**

Phytomedicine is the greatest remedy to combat health issues in human and animals. It is understood that bioactive molecules isolated from Indian traditional herbs play a major role in curing diseases and disorders. In line with the above, application of phytomedicine is demonstrated in aquatic animal health also with respect to viral infection in shrimp.





## Lead Lectures

### **Dr. P. Sathiyarajeswaran**

Director and In-Charge  
Siddha Central Research Institute  
Ministry of AYUSH



### **Dr. Kannabiran Krishnan**

Senior Professor  
School of Biosciences and Technology,  
Vellore Institute of Technology, Vellore,  
Tamil Nadu, India.

### **Dr Karthik L**

Project Lead - Synthetic Biology  
Salem Microbes Pvt. Ltd.,  
Salem, Tamil Nadu, India.



### **Dr Kasi Gopinath**

Post Doctoral Fellow,  
School of Materials & Energy,  
Southwest University in Chongqing,  
Beibei, China



## Lead Lectures

### **Dr. Sailendra Singh**

Post Doc Fellow  
Department of Plant Sciences  
Migal Galilee Research Institute, Israel



### **Dr. Mohanasrinivasan V**

Associate Professor  
School of Biosciences and Technology,  
Vellore Institute of Technology, Vellore,  
Tamil Nadu, India.

### **Dr Sudhakaran K**

Assistant Professor Sr.  
School of Biosciences and Technology,  
Vellore Institute of Technology, Vellore,  
Tamil Nadu, India.



### **Dr. John Adams S**

Post Doctoral Research Associate,  
NCNPR,  
University of Mississippi, USA.



## Organizing Committee

### Chairman



**Dr. Fr. S. Xavier, SJ**  
Research Director



**Fr. Denzil E. Lobo, SJ**  
Director SJIT

### Advisory Board



**Dr. Beatrice Sequeria**  
Dean  
School of Life Sciences



**Dr. Jayarama Reddy**  
Head of Dept.  
Department of Botany



**Dr. Jacob Paul VJ**  
PG Coordinator  
Department of Botany



## Faculty Organizers



**Dr Lokesh Ravi**  
Convener



**Dr Nithaniyal Stalin**  
Organizer



**Dr Neelam Mishra**  
Organizer





## Post-Graduate Student Organizers



**Mr. Sharun Roy D'Souza**  
(M.Sc.Botany 2<sup>nd</sup> Year)



**Ms. Shree Kumari GR**  
(M.Sc.Botany 1<sup>st</sup> Year)



**Mr. Suneesh VS**  
(M.Sc.Botany 1<sup>st</sup> Year)



**Ms. Archana O**  
(M.Sc.Botany 1<sup>st</sup> Year)



## Under-Graduate Student Organizers



**Mr. Prashanth**  
(3<sup>rd</sup> Year CBBT)



**Mr. Ajith Kumar K**  
(3<sup>rd</sup> Year CBBT)



**Mr. Sagar Timothy**  
(3<sup>rd</sup> Year MCB)



**Ms. Akanksha**  
(1<sup>st</sup> Year BBZ)



**Mr. Jose Mathew**  
(3<sup>rd</sup> Year UG)



**Ms. Namratta**  
(2<sup>nd</sup> Year MCB)



**Ms. Mansi K**  
(1<sup>st</sup> Year BBZ)



**Ms. Sakshi P**  
(1<sup>st</sup> Year BBZ)



## Sponsors



**Zastra Innovations Pvt. Ltd.,**  
*Bengaluru, Karnataka, India*



**Juniper Life Sciences Pvt. Ltd.,**  
*Bengaluru, Karnataka, India*



**Sai Scientific Instruments**  
*Bengaluru, Karnataka, India*



**Deccan Data Forms**  
*Bengaluru, Karnataka, India*



**TRION DESIGNS - INDIA**

**Trion Designs India**  
*Paschim Burdwan, West Bengal, India*



## Prize Winners

### Paper Presentation: Prize Winners

#### Best Paper Presentation in “Pharmaceutical Phyto-Medicine” Theme

**Mr. Wudali Narasimha Sudheer**

*CHRIST (Deemed to be University), Bengaluru, Karnataka*

“Production of Boeravinone-B from in vitro callus cultures of Punarnava  
(*Boerhavia diffusa* L.)”

#### Best Paper Presentation in “Bioinformatics Approach to Phyto-Medicine”

**Ms. Priyanka K**

*Sri Ramachandra Institute of Higher Education and Research, Chennai,  
Tamil Nadu*

”To Decipher The Natural Compound Activity Against SLC17A5 Protein Causing  
Free Sialic Acid Storage Disorders: A Computational Approach”

#### Best Paper Presentation in “Genomics & Proteomics of Phytomedicine”

**Ms. Nagaveni. C**

*Bangalore University, Bengaluru, Karnataka*

“Molecular Characterization of in-vitro propagated plants of *Aerva lanata* (L.) Juss.  
ex Schult. using RAPD markers”

#### Best Paper Presentation in “Natural Products Against Covid” Theme

**Ms. Preethi K**

*Krupanidhi College of Pharmacy, Bengaluru, Karnataka*

“Seaweeds: A Rational Approach Towards COVID-19 Receptor-Binding Domain  
via Molecular Docking Studies”

#### Best Paper Presentation in “Phyto-Chemistry in Nanotechnology” Theme

**Ms. Dharani B**

*Alagappa University, Karaikudi, Tamil Nadu*

“Green Synthesis Of Cerium Oxide Nanoparticles Using Pandanus amaryllifolius  
Leaf Extract And Their Evaluated The Biological Application”



## Poster Presentation: Prize Winners

### **Best Poster Presentation in “Pharmaceutical Phyto-Medicine” Theme**

**Mr Madhan kumar**

*Sri Ramachandra Institute of Higher Education and Research, Chennai,  
Tamil Nadu*

“Modelling Intracerebral Haemorrhage in Adult Zebrafish to Study  
Neuromodulatory Effects of Asiaticoside”

**Ms. Varsha Rani**

*REVA University, Bengaluru, Karnataka*

“Behavioural Analysis of *Drosophila melanogaster* to Different Stress Models and  
Identification of Neuroprotective Compounds in Selected Plants”

### **Best Poster Presentation in “Bioinformatics Approach to Phyto-Medicine”**

**Ms Shatakshi Mishra**

*St. Joseph's College (Autonomous) Bengaluru, Karnataka*

“Selection Of Phytochemicals From Calendula Officinalis: Potent Inhibitor Of  
*Streptococcus iniae*”

## Scientific Events : Prize Winners

**Debate:**

**Ms. Tunga PR**

*Mount Carmel College, Bengaluru, Karnataka*

**Quiz:**

**Mr Ganesh V**

*St. Joseph's College (Autonomous) Bengaluru, Karnataka*



# Abstracts



# Pharmaceutical Phyto-Medicine



## Midostaurin Inhibits Proliferation of Castrate Resistant PC-3 Cells Via G1/S Phase Cell Cycle Arrest

---

Kavya K, D. Manjulakumari

Department of Zoology,  
St. Joseph's College (Autonomous)  
Bengaluru, Karnataka.

---

### Abstract:

The evolution of prostate cancer from a clinically localized hormone-naïve state to a castrate resistant phenotype involves a complex interplay of signalling pathways including Protein Kinase C (PKC). PKCs have been linked to carcinogenesis since PKC activators such as phorbol 12-myristate 13-acetate (PMA) can act as tumour promoters. Furthermore, functional studies have suggested that PKC affects the phenotype of high-grade cancers like skin, colon, ovarian, brain, lung, breast including prostate, and therefore support its role not only in early carcinogenesis but also in cancer progression. Hence, the present study aims to regulate the implication of PKC through Midostaurin a multi-target protein kinase inhibitor. AR negative castrate resistant prostate cancer PC-3 cells were used as an in-vitro model system. The effect of midostaurin on the cell viability was assessed by MTT assay. Expression studies on PKC- $\alpha$ , PKC- $\delta$  and genes regulating E2F pathway were analysed by semi-quantitative RT-PCR. Midostaurin decreased the viability of hormone refractory PC-3 cells. Further, midostaurin significantly induced the transcripts of apoptotic mediated PKC- $\delta$ , tumor suppressor Rb and p53, cell cycle inhibitor p21<sup>cip1</sup>/waf1, and eventually inhibited the expression of pro-survival PKC- $\epsilon$ , transcription factor E2F, and its regulating genes such as positive growth regulator cyclin D1 and E1. Our studies provide evidence that midostaurin suppresses tumor growth by regulating genes involved in E2F pathway via G1/S phase cell cycle arrest in hormone refractory prostate cancer PC-3 cells. Hence, pharmacological targeting of PKC may have therapeutic potential against castrate resistant prostate cancer.





## Phytomedicinal Constituents in *Terminalia catappa* varieties, an Indian Almond

Farzana Tasneem MI  
Dr. Asma Saqib

Department of Biotechnology, Surana  
College (Autonomous), Bangalore-04.

### Abstract:

*Terminalia catappa* is an ornamental tropical tree belonging to the family Combretaceae is native to Southeast Asia in the tropical regions of Asia, Africa, and Australia commonly called Indian Almond. In our study, we have taken varieties of *Terminalia catappa* plant extract and conducted GCMS Study. The *Terminalia catappa* T1Y and T2R varieties were subjected to GCMS analysis and chromatogram percentages with peak area are observed. The result of phytocompounds as GCMS analysis of *Terminalia catappa* in methanol extract of T1Y variety showed 13 peaks. The T1Y variety identified compounds shows the highest peak areas, Ethylsilatrane (39.4 RT), Methyl 10-octadecenoate (38.75), 7,9-Di-tert-butyl-1-oxaspiro (4,5) deca-6,9-diene-2,8-dione (35.39) Terephthalic acid, 2-methoxybenzyl pentyl ester (35.04) and lowest peak areas are Isocapro lactone (7.53, 7.64) Analgesic and retinoic compound. 2,3-Dimethyl-3-buten-2-ol (7.97), Allyl heptanoate (8.23), Crotylhydrazine (8.29),  $\alpha$ -Ketocaprylic acid (8.58), 3,4-Dimethyl-5-isoxazolol (8.66), and moderate peak area for N-Methylimidazole (18.28), T1 Yellow variety peak area percentage showed highest for 2,3-Dimethyl-3-buten-2-ol (24.75) and the lowest for 3,4-Dimethyl-5-isoxazolol (3.3). The compounds present in the T1 variety like Ethylsilatrane (39.4 RT) and Methyl 10-Octadecenoate (38.75) are used in Industrial application and Downstream production. The product by showing the highest peak area 2,3-Dimethyl-3-buten-2-ol (24.75) and Allyl heptanoate with (18.78) are used as pharmacokinetics (Food additives) and Food grade and Flavor agent T2R variety showed 9 peaks, highest peak area was benzothiazole, 2-(2-hydroxyethylthio) (35.7), lowest peak area was Isocapro lactone (7.5) and other compounds are  $\delta$ -Hydroxyvaleramide (7.61), N-Butyryl-L-homoserine lactone (7.95), Crotylhydrazine (8.29), Allyl heptanoate (8.51),  $\alpha$ -Ketocaprylic acid (8.58) and 3,4-Dimethyl-5-isoxazolol (8.66). The percentage of peak area is Butyryl-L-homoserine lactone (25.69) and the lowest is 3,4-Dimethyl-5-isoxazolol (2.72). In the T2 R variety the highest peak area chemical compounds-Butyryl-L-homoserine lactone (7.95) and Allyl heptanoate (8.51) were used in the formation of biofilm and Aroma chemicals, Benzothiazole, 2-(2-hydroxyethylthio) which is used as an antioxidant was also observed. many compounds are yet to discover as a future line of work.



## Extraction and Characterization of the Carotenoids form Heterotrophic Bacteria Isolated from Biofilms

Royston Madtha  
Ashok Kumar Chakka  
Lyned Lasrado  
Asha Abraham

Department of Postgraduate Studies &  
Research in Biotechnology,  
St Aloysius College, (Autonomous),  
Mangalore, Karnataka.

### Abstract:

Carotenoids are secondary metabolites and have a diverse role in microorganism such as protecting them from UV and oxidative damage, and are involved in maintaining membrane fluidity. Although naturally occurring carotenoids are mainly present in plants, algae and fungi, they are also present in bacteria and other microorganisms. On account of the importance of carotenoids to human health, a rapid method for the production and the ease of extraction of the carotenoids from microorganisms would provide a technological advantage over the conventional extraction methods from plants. The free-floating biofilm which is present in the natural environment is a natural habitat which harbours large numbers of microorganisms. In this study, the bacteria were isolated from the biofilms, standardised for the growth conditions and screened for the presence of natural pigment. The carotenoid producing organisms were characterised by 16s rRNA and phylogenetic analysis. The pigment producing organism was identified as *Erythrobacter* sp. The UV spectra of the bacterial extract displayed the presence of a broad spectrum of compounds belonging to the family of carotenoids. The absorbance at 480 nm indicated the presence of carotenoids, which was further confirmed by FTIR, and the yield was calculated. Growth conditions for the production of pigments, and process of extraction of the bacterial pigments were also standardized We report a scalable, less laborious method for the culture of an unexplored microorganism and extraction of a variety of carotenoids.



## Evaluating the Antidiabetic and Anti-Inflammatory Activity of *Acacia nilotica* Bark Aqueous Extract

---

Janani Manoharan  
Babujanarthanam Ranganathan

Auxilium College (Autonomous),  
Vellore, Tamil Nadu.

---

### Abstract:

From the formation of the human race, plants holding medicative features were imperative in the human aliments. The applicability of the plants is clearly presented in the tradition as well as other coding system of medicine. The ancient system of Indian Ayurveda has clearly provided the involvement of active plant moiety and various parts in the documented form for regaining the health condition from chronic health damages with pharmacological and therapeutic perspectives. *Acacia nilotica* (*A.nilotica*), belonging to the family of Mimosaceae is one of the imperative medicament applied globe-wide and also vital in therapeutic plant in the system of Indian Ayurveda. The phytochemical profiling of the bark aqueous extract displayed the existence of alkaloids, flavonoids, tannins, terpenes, glycosides and phenolic components. Antidiabetic activity of bark aqueous extract studied using  $\alpha$ -amylase enzyme and  $\alpha$ -glucosidase inhibition test displayed dose-based form of antidiabetic activity by inhibiting the impact of both the enzymes. Also, anti-inflammatory activity was evaluated applying the bovine serum albumin (BSA) assay, which depicted superb anti-inflammatory activity in a dose-based manner was observed.



## Antagonistic Activity of Endophytic Fungi from *Merremia emarginata* Against Bacterial Fish Pathogens

---

Saranya Shankar  
Mythili Sathiavelu

School of Biosciences and Technology,  
Vellore Institute of Technology,  
Vellore, Tamil Nadu.

---

### Abstract:

Aquaculture has been considered an important sector in developing countries by increasing its contributions to food security. However, disease occurrence has become one of the basic constraints in India by affecting the socioeconomic status of the fisheries. In particular, Bacterial fish diseases are responsible for huge mortality in both cultured and wild fishes. Resistance of pathogens to antibiotics and reduced efficacy has needed for new alternatives development against bacterial pathogens in aquaculture production. Microorganisms are playing a vital role in drug development and one such alternative is the use of endophytic fungi to avoid bacterial infections in aquaculture. The present study aims to analyze the in vitro antibacterial, antioxidant activity and phytochemical screening of fungal leaf crude extracts from the medicinal plant *Merremia emarginata*. A total of four morphologically different endophytic fungi were isolated from *M. emarginata* leaves and screened for antibacterial by agar well diffusion method against the bacterial fish pathogens including *Aeromonascaviae*, *Aeromonashydrophila* and *Edwardsiellatarda*. The dichloromethane extract from *Aspergillus flavus* showed antagonistic activity against *Aeromonascaviae* (16mm), *Aeromonashydrophila* (19mm) and *Edwardsiellatarda* (16mm). The results conclude that the medicinal plant *Merremia emarginata* might be a significant source of antibacterial compounds for the treatment of fish diseases.



## Anti-MRSA Activity of Endophytic Fungi *Aspergillus niger* from *Polianthes tuberosa*

---

Ranjitha Dhevi V. Sundar  
Sathiavelu Arunachalam

School of Biosciences and Technology,  
Vellore Institute of Technology,  
Vellore, Tamil Nadu.

---

### Abstract:

Antibiotic resistance is becoming a crucial concern for public health and the rapid development of the resistance phenomenon has driven researchers to continuously expose novel antibacterial agents. Endophytic fungi harboring in healthy plant tissues serves as the potent resources for active compounds that have a wide range of medical, agricultural and industrial application. The present work is a brief study on the anti-MRSA properties of crude extracts obtained from the endophytic fungi *Aspergillus niger* isolated from *Polianthes tuberosa*. Qualitative phytochemical screening was carried out using standard biochemical assays. DPPH radical scavenging assay was done to determine the antioxidant activity. Antibacterial activity was studied using the agar well diffusion method against Methicillin-resistant *Staphylococcus aureus* (MRSA). The antibacterial study revealed that dichloromethane extract demonstrated significant antibacterial activity with a zone of inhibition of 19mm against at 1 mg/ml concentration followed by ethyl acetate extract showed 17mm of a zone of inhibition whereas butanol extract has no antagonistic activity. The results suggest that the endophytic fungi *Aspergillus niger* contain remarkable potential pharmaceutical applications thereby, its compound can further be used as lead molecules to overcome the infections caused by resistant microbes.



## ***Antibacterial Activity of *Cymbopogon winterianus* Against Methicillin Resistant *Staphylococcus aureus* (MRSA)***

Vinutha M  
Lakshmikanth R.N  
Shravani S  
Divyashree B  
Aishwarya K  
Nagaraj M.M

MS Ramaiah College Of Art Science  
And Commerce,  
Bengaluru, Karnataka.

### **Abstract:**

Antibiotic resistance in bacteria has become a serious threat to mankind throughout the world. Methicillin Resistant *Staphylococcus aureus* (MRSA) has shown high fatality rate globally due to its resistance to first and second line of antibiotics. Medicinal plant extracts and essential oil (EO) formulations could be the choice of treatment to overcome antibiotic resistance in bacteria. Essential oil of *Cymbopogon winterianus*, a well-known medicinal and aromatic plant is used in the current study against five clinical isolates of MRSA. The essential oil was analysed for its chemical constituents using Gas Chromatography Mass Spectroscopy (GCMS) which indicated the presence of important compounds such as D-Limonene,  $\beta$  Linalool, Citronellal, Isopulegol, Citronellol, Geranial, Geraniol, Neral, Eugenol,  $\beta$  Elemene, Germacrene D, Elemol, Cubenol, Cadinol and Caryophyllene. The antibacterial activity of EO assessed through Minimum Inhibitory Concentration (MIC), Agar well diffusion and Disc diffusion methods showed MIC in the range of 4-32 $\mu$ l/ml and zone of inhibition at the concentration of 35-55% for agar well diffusion and disc diffusion methods. The results indicate the possible use of *C.winterianus* EO as a natural alternative treatment for MRSA infections.



## Characterization of Chemical constituents of Phytomedicine Prepared for the treatment of Infant Dysentery by Grassroots Innovators using HPTLC Profiling

Mohankumar S  
Anil K Gupta  
Neeta Srivastava

Department of Food Science and Technology,  
St. Joseph's College (Autonomous), Bengaluru

SRISTI, AES Boys Hostel Campus, Near Gujarat  
University Library & SBI Bank, Navrangpura,  
Ahmedabad, Gujarat.

B V Patel PERD Centre, Ahmedabad, Gujarat,

### Abstract:

Natural products from medicinal plants, either as pure compounds or as standardized extracts, provide unlimited opportunities for new drug leads because of the unmatched availability of chemical diversity. In the present study, chemical profiling of the phytomedicine prepared using *Trachyspermum ammi* L. Sprague, *Aegle marmelos* L. Correa and *Holarrhena antidysenterica* L. Wall. for the treatment of infantry dysentery was performed by High Performance Thin Layer Chromatography (HPTLC) method. The extract was prepared using hexane, ethylacetate, methanol and water. The qualitative estimation of phytochemicals like alkaloids, flavanoids, phenolics, terpenoids, tannins and saponins were performed according to standard methods. The TLC fingerprinting and HPTLC profiling were carried out to identify the chemical constituents present in the extracts. The results showed that the ethanolic extract of all the three plants showed presence of alkaloids and terpenoids. Saponins were absent in all the three plants extracts. The TLC fingerprinting of the methanolic, ethyl acetate and hexane extracts of *Trachyspermum ammi* L. Sprague, *Aegle marmelos* L. Correa and *Holarrhena antidysenterica* L. Wall. showed 7, 10, and 7 prominent bands with a RF values varying between 0.1 and 0.9. The HPTLC profiling of ethyl acetate extract of *Trachyspermum ammi* L. Sprague showed presence of Thymol. Similarly methanolic extract of *Trachyspermum ammi* L. Sprague showed presence of Beta-sitosterol. The HPTLC profiling of methanol, ethyl acetate and hexane extracts of *Aegle marmelos* L. Correa and *Holarrhena antidysenterica* L. Wall. showed presence of Beta-sitosterol and Lupeol. From the study we concluded that the presence of Thymol, Beta-sitosterol and Lupeol have contributed in the treatment of infant dysentery. Further work is required to design the formulation and dosage of this phytomedicine for administration to infants for the treatment of dysentery.



## Cytotoxicity & Cell Cycle Arresting Potential of *Ficus racemosa* Leaves

---

R Rachael Evangeline  
Betty Daniel

Department of Botany,  
St. Joseph's College (Autonomous)  
Bengaluru, Karnataka.

---

### Abstract:

**Aim:** To assess the anticancer properties of leaf extracts derived from *Ficus racemosa* against HeLa cells. **Methodology:** Three different extracts (water, ethanol, and ethyl acetate) of *Ficus racemosa* leaves were obtained and subjected to phytochemical screening, cytotoxic assay, cell cycle analysis assay, antioxidant assay. The ethyl acetate extract that exhibited maximum cytotoxic activity against the HeLa cell lines was taken for GC-MS analysis. **Results:** The genus of the plant was confirmed through phylogenetic and molecular analysis. Of the three solvent extracts (water, ethanol, and ethyl acetate) subjected to cell-cytotoxicity assay against HeLa cell lines, ethyl acetate extract conferred the maximum toxicity with an IC<sub>50</sub> of 80 µg/ml. Further, the flow-cytometry cell cycle analysis showed that the ethyl acetate extract at 160 µg/ml confer minimum percentage of viable HeLa cells at G<sub>0</sub>/G<sub>1</sub>. However, the DPPH antioxidant assay showed the ethanol extract to have the maximum IC<sub>50</sub> of 30.19 µg/ml. The GC-MS analysis for the ethyl acetate extract could identify seven compounds, wherein secondary metabolites like Pentadecanoic acid, lupeol have already been shown in reducing oxidative stress and maintaining metabolism. But the comprehensive studies need to be done to understand the pharmacokinetic properties of the compounds. **Conclusion:** The experiment provides new insight into the therapeutic potential of leaves of *Ficus racemosa* as an anticancer agent.





## Effect of Extraction Condition on Phenolic Content, Flavonoid Content and Antioxidant Property Of *Musa x paradisiaca* (AAB) Palayankodan Pseudo Stem

Jaya Gangwar  
Joseph Kadanthottu Sebastian

CHRIST (Deemed to be University)  
Bengaluru, Karnataka.

### Abstract:

**Background:** *Musa x paradisiaca* (AAB) Palayankodan is extensively used and grown in India and over 120 other countries. Several authors have recorded strong antioxidant activity and phytochemical properties of banana (*Musa*), higher the amount of phenolic compounds higher will be the mineral activity. Banana pulp had reported as it is having antioxidants like vitamins (A,B and E), $\beta$  – carotene [16] and the phytochemical compounds like catechin, epicatechin, lignin, tannin, gallic acid and anthocyanins like peonidin and malvidine. *Musa* plants are utilized in the manufacture of fiber and are frequently employed in the paper industry. The purpose of this study is to determine the effect of solvent types (Methanol, Ethanol, Water, Chloroform, Hexane, Acetone), solvent-to-sample ratio (20-100mL/g), solvent acidity (0.25 percent), extraction time (30-150 minutes), and extraction temperature on total phenolic content (TPC), total flavonoid content (TFC), and free radical scavenging capacity of (2,2'-diphenyl-1-picrylhydrazyl (DPPH)). **Methodology:** The pseudo stems were separated, thoroughly rinsed with tap water, sliced into little pieces, and dried in the sun for four days. The dry material was ground with a grinder, and the powder was kept in airtight vials. The dried powder was combined with solvents such as methanol, ethanol, hexane, water, and chloroform in a 1:20 (1 g in 20 ml of solvent) ratio. To get the solid bulk, the extract was concentrated using a rotary evaporator. Methanol, ethanol, water, hexane, acetone, and chloroform yielded 48 percent, 38 percent, 25 percent, 17 percent, 40 percent, and 32 percent, respectively. The five factors used to evaluate the circumstances under which the total phenolic and flavonoid content of *Musa* pseudo stem is extracted. **Results:** The best extraction conditions were obtained by using a water-to-methanol ratio of 1:80 and a methanol-to-water ratio of 1:20. The solvent acidity was best demonstrated in a 1.25 percent HCl methanol extract of solvent acidity. The extraction temperature of 70°C and the extraction times of 90 and 60 minutes yield the highest quantity of TPC and TFC. The Pearson's correlation analysis was performed, and the findings demonstrated a substantial relationship between TPC and TFC and antioxidant activities.



## Effect of Precursor on the Biosynthesis of Psoralen and Bergapten in Callus Culture of *Ruta graveolens* L., a Medicinal Plant

---

V. T Gaganashree  
B. L Manjula

Sri Jagadguru Renukacharya College of  
Science, Arts and Commerce,  
Bengaluru, Karnataka.

---

### Abstract:

*Ruta graveolens* L., commonly known as Rue is known to contain furanocoumarins which have gained wide applications in pharmaceutical industry. In vitro callus production is an alternative source to produce furanocoumarins. Callus tissue was raised from the nodes of *Ruta graveolens* on MS medium supplemented with growth regulators and amino acids. L-Phenyl alanine was used as a precursor to increase the production of Psoralen and Bergapten in the callus cultures. NAA (10.74 $\mu$ M) + BAP (4.44 $\mu$ M) supplemented with L-Phenyl alanine of various concentrations yielded more callus. HPLC analysis revealed that nodal extract contained less amount of Psoralen and Bergapten whereas Psoralen was absent in nodal derived callus. The highest amount of Bergapten of 27.45 mg/g DW was produced in the callus raised on MS medium supplemented with NAA (10.74 $\mu$ M) + BAP (4.44 $\mu$ M) + L-Phenyl alanine (2.42mM).



## Efficacy of Endophytic Fungus APR2 Isolated from *Andrographis paniculata* Root as a Biocontrol Agent Against Soilborne Fungal Phytopathogens

---

Gayathri Segaran  
Mythili Sathivelu

School of Biosciences and Technology,  
Vellore Institute of Technology,  
Vellore, Tamil Nadu.

---

### Abstract:

Endophytic fungi live symbiotically with their plant hosts and are well recognized as a rich source of natural compounds. Endophytes can help plant development by secreting a variety of phytohormones. The prominent role of these fungi in agriculture, medicine, and pharmaceuticals could be able to fulfill the present demand for novel biomolecules. The endophytic fungal isolate APR2 was isolated from the root of *Andrographis paniculata* and their antagonistic activity against the soil-borne phytopathogens were investigated. Antagonistic activity of fungal isolate APR2 was determined towards *Fusarium oxysporum*, *Macrophomina phaseolina* and *Rhizoctonia solani* by dual culture assay and double plate method. In dual culture assay, higher antagonistic activity was found towards *R. solani* (86%) followed by *M. phaseolina* (71%) and *F. oxysporum* (63%) through mycoparasitism. In addition to mycoparasitism, VOCs released from APR2 demonstrated a strong antagonistic effect towards all three pathogens and suppressed mycelial growth in a double-plate experiment. In in vitro bioassay, the mycelial growth of phytopathogens *M. phaseolina* and *R. solani* were inhibited by crude extracts obtained from liquid cultures of APR2. Isophorone, maltol, phenol, p-Cresol, pantolactone and phenyl ethyl alcohol are the antimicrobial substances detected in the GC-MS analysis of ethyl acetate crude extract. These results indicate that the fungal isolate APR2 can produce antifungal compounds and thus both the isolate and its bioactive metabolites could be used as bio fungicides for sustainable agriculture. The utilization of fungal-based products presents a unique chance to identify novel therapeutic agents to tackle a variety of agricultural pests and infectious diseases.



## In Vitro Anti-Diabetic and Antioxidant Potential of Endophytic Fungi Isolated from *Bryophyllum pinnatum* L.

Sugashini Settu  
Sathiavelu Arunachalam

School of Biosciences and Technology,  
Vellore Institute of Technology,  
Vellore, Tamil Nadu.

### Abstract:

Diabetes is a chronic metabolic disease and one of the leading causes of death compared to all health issues. Diabetes drugs can be used to regulate the activity of metabolic enzymes, including amylase, in diabetic patients. Endophytes are a group of microorganisms that reside in the internal tissue of all higher plants without causing any of the symptoms they live in. Endophytic fungi isolated from plants can serve as a reservoir of secondary metabolites, since they can prevent diabetes through alpha amylase activity. Current research has isolated endophytic fungi from the leaves of *Bryophyllum pinnatum* and includes extracts of dichloromethane (DCM), ethyl acetate (EA), butanol (BuOH) and methanol (MeOH) was carried out to study antioxidant and antidiabetic activities. Twenty two (BPL1-BPL22) endophytic fungi were isolated from the leaves and their phytochemical presence was examined. Based on the presence of phytoconstituents, 11 endophytic fungi were chosen to analyze its radical scavenging and antidiabetic activities. In a radical scavenging assay, the fungal crude extracts as shown a dose-dependent activity. The fungal crude extracts was determined for its antidiabetic potential via alpha-amylase and glucose uptake by yeast cell studies. The maximum alpha inhibitory activity was shown by DCM, EA and MeOH extracts of BPL20 isolate of about  $52.03 \pm 0.31$ ,  $52.72 \pm 0.81$  and  $57.67 \pm 0.66$  respectively. The glucose uptake by yeast cells by fungal crude extracts was evaluated and MeOH extracts of BPL20 as shown  $54.27 \pm 0.19\%$  of glucose uptake at 1mg/ml concentration. The results revealed that the hypoglycemic activity of fungal crude extracts has been found, therefore further studies are involved in isolation and purification of bioactive compounds and to perform in vivo studies.



## Phytochemical Screening and GC-MS Profiling of Tamarindus Indica Fruit Peel Extract

---

Adinath N Tavanappanavar  
Sikandar I. Mulla

REVA University  
Bengaluru, Karnataka.

---

### **Abstract:**

Tamarindus indica is used as one of the most important drugs in traditional system of medicine to treat various ailments. The aim of this study is to screen the phytochemicals present in the fruit peel extract of different solvent such as methanol, ethyl acetate and chloroform and analysis of the components present in it by GC-MS analysis. The sample was sequentially extracted by different solvents. The results showed the presence of phytochemical compounds of alkaloids, saponins tannins, phenol, flavonoids, sterols, majority of extract was exhibited in ethanol extract. The GC-MS analysis with different extract revealed the presence major compounds such as neophytadiene, hexahydrofarnesylacetone, hexadecanoic acid, 1-phenyl-2-pyrazoline, 9,12-octadecadienoic acid, hexadecanamide, octadecanamide, eicosane etc. This study forms a basis for the biological characterization and importance of the compounds identified and creates a platform to screen many bioactive components to treat many diseases.



## Poly herbal Oro-Dispersible Formulation Containing Mouth Freshener

Ramachandra T S  
Sujani Kamble  
Anitha.S  
Chaitramani B.S

Department of Pharmacognosy,  
Government College of Pharmacy,  
Bengaluru, Karnataka.

### Abstract:

**Aim:** Preparation of oral-dispersible formulation containing poly herbal mouth freshener and antibacterial activity. **Methods:** In the present work, ODTs containing various naturally occurring mouth freshener extracted from Clove (*Eugenia caryophyllus* Thumb., family Myrtaceae), Cardamom (*Elettaria cardamomum* Motanvar, family Zingiberaceae) and Ginger (*Zingiber officinale* Roscoe, family Zingiberaceae) were prepared by direct compression method with a view to enhance patient compliance. Volatile oils from respective drugs were isolated by Hydrodistillation method using Clevenger's apparatus using water as a solvent. Extracted oils were dispersed with mannitol using alcohol and used for direct punching using superdisintegrants, viz., sodium starch glycolate. The four formulations F1, F2, F3 and F4 (clove oil, cardamom oil, ginger oil and mixture of all extracted oils respectively) were prepared, preformulation parameters such as angle of repose, bulk density, tapped density, hausner's ratio were performed and results were recorded and post formulation parameters such as hardness, thickness, weight variation, disintegration time, friability were carried out. **Results:** The yield of volatile oil was found to be Clove (10.50%w/v), Cardamom (8.50%w/v) and Ginger (0.64%w/v). The results for F1 formulation were found to be Angle of repose ( $24^{\circ} 69'$ ), Bulk density ( $0.322\text{g/cm}^3$ ), Tapped density ( $0.3903\text{g/cm}^3$ ) Hausner's ratio (1.18), hardness ( $2.47\text{kg/cm}^2$ ), thickness ( $2.47\text{mm}$ ), weight variation (125.03mg), disintegration time (25 sec), friability (0.626 %). For F2 formulation Angle of repose ( $24^{\circ} 70'$ ), Bulk density ( $0.324\text{g/cm}^3$ ), Tapped density ( $0.397\text{g/cm}^3$ ) and Hausner's ratio (1.16), hardness ( $2.53\text{kg/cm}^2$ ), thickness ( $2.44\text{mm}$ ), weight variation (124.77mg), disintegration time (24 sec), friability (0.67 %). For F3 formulation Angle of repose ( $24^{\circ} 68'$ ), Bulk density ( $0.326\text{g/cm}^3$ ), Tapped density ( $0.397\text{g/cm}^3$ ) and Hausner's ratio (1.18), hardness friability (0.50 %). For F4 formulation Angle of repose ( $24^{\circ} 64'$ ), Bulk density ( $0.328\text{g/cm}^3$ ), Tapped density ( $0.398\text{g/cm}^3$ ) and Hausner's ratio is (1.18) hardness ( $2.66\text{kg/cm}^2$ ), thickness ( $2.47\text{mm}$ ), weight variation (125.23mg), disintegration time (28sec), friability (0.47%). **Conclusion:** ODTs containing poly herbal formulation may be effective in dental caries or in treatment of dental infection. In present study Clove, Cardamom and Ginger Oils have been used for preparation of ODTs and these drugs are used as Mouth freshener. Hence this poly herbal mouth freshener formulation in form of ODTs may be useful as a home remedy for dental carries. Which if not treated may lead to Oral cancers.



## Scientific Validation of Tribal Claims on Plants Used in Diabetes

---

Sinu Aradhana  
B.L.Manjula  
Sanjeet kumar

Sri Jagadguru Renukacharya College Of  
Science, Arts And Commerce,  
Bengaluru, Karnataka.

---

### Abstract:

Diabetes is a disorder in which the ability of body to produce or respond to insulin hormone is impaired which results in abnormal metabolism of carbohydrates and elevated levels of glucose in the blood. If this is not controlled properly it leads to damage of organs. Medicinal plants are playing a vital role in the management of diabetes globally and used by the ethnic communities of the world. The Santhal community belongs to the Munda ethnic group native to India. They have good indigenous traditional knowledge about the medicinal uses of plants. A field survey was conducted in the District of Mayurbhanj, Odisha, to collect the information about the plants used by Santhal in diabetes. Five plants were selected (*Andrographis paniculata*, *Indigofera cassioides*, *Centella asiatica*, *Woodfordia fruticosa* and *Curcuma aromatica*) from the enumerated plants used by the Santhal in diabetes. The aqueous extract of these plants showed no cytotoxicity when tested on *Artemia salina* too and showed the presence of diverse bioactive compounds might be responsible to inhibit the alpha glucosidase enzyme activity. The results revealed that selected plants might have potential in management of diabetes.



## Screening for Antioxidant Activities from the Crude Plant Extracts of *Hibiscus* Sp.

---

Indumathi P  
Abi Beaulah

Auxilium College (Autonomous)  
Vellore, Tamil Nadu.

---

### Abstract:

Plants have played an important role in the life of human being as they provide the basic need of mankind that is food, clothing, shelter, and medicines. They have formed the basis of traditional medicine system among which are Ayurvedic, Unani etc. that have been in existence for many decades and continue to provide mankind with new remedies. In developing countries, a large section of the population relies on medicinal plants for primary health care requirements. The traditional medicines are becoming popular because they are cheap, abundant with less adverse effect on health. In recent years, focus on plant research has increased globally to find out the immense potentials of medicinal plants used in various traditional systems. Various medicinal plants have been studied which could be used as potent phytochemical agents in the therapeutic treatment of various diseases; one among them is Hibiscus known for its delicacy and medicinal properties which has several health benefits. Research reports highlighted the dried calyces as the potential source of bioactive molecules that exert potent antioxidant-antiradical activity, anti-inflammatory action, antiobesity, antihyperlipidemic, antihypertensive, inhibition of blood platelets aggregation, diuretic, antiurolithicatic, antimicrobial, anticancer, hepatoprotective, renoprotective, antitumour, immunomodulatory properties. Thus, the present study is designed to investigate the antioxidant activities from the plant extracts of Hibiscus sp. Hence, in the current study, we screened the antioxidant capacity of crude extracts of Hibiscus and showed that the ethanolic leaf extracts of Hibiscus sp. is high and these extracts exhibit strong antioxidant activities compared to that of the standard compounds. The results would help to ascertain the potency of the crude extract from Hibiscus could act as potential source of natural antioxidants. It can be used for minimizing or preventing lipid oxidation in pharmaceutical products and retarding the formation of toxic oxidation products. Further studies on definitive mechanisms of its chemotherapeutic activities and potential effects in vivo are warranted.





## Screening of Phytochemicals from Thermophilic Fungi Isolated from the Compost of Mixed Vegetable Waste

---

M Geetha  
P.Anitha, Smt Ashalatha  
Lt Ranjith Kumar HT

B M S College for Women Basavangudi,  
Bengaluru, Karnataka.

---

### Abstract:

Compost is the end product of a complex feeding pattern involving millions of different organisms which replicates nature's natural system of breaking down materials of organic matter. During composting micro-organisms convert organic materials such as manure, sludge, leaves, fruits, vegetables and food wastes into product like soil humus. Thermophilic fungi are the chief components of the microflora that are developed in the heaped masses of plant material. Thermophilic fungi were isolated on Potato Dextrose Agar (PDA) media. The fungal cultures were purified, mass multiplied and then screened for the presence of different phytochemicals such as alkaloids, phenols, tannins following the standard procedure. Alcoholic extract of *Malbranchea cinnamomea* showed higher phenolic and flavonoid content. *Malbranchea cinnamomea* has an ability to produce various secondary metabolites which will be useful in Bio- pharmaceuticals and therapeutics.



## Production of Boeravinone-B from In Vitro Callus Cultures of Punarnava (*Boerhavia diffusa* L.)

---

W N Sudheer  
Praveen N

CHRIST (Deemed to be University)  
Bengaluru, Karnataka.

---

### Abstract:

*Boerhavia diffusa* Linn. is a medicinal herb rich in diversified plant secondary metabolites used in curing various health ailments. It is commonly known as Punarnava in Sanskrit for its ability to rejuvenate the life. Boeravinone B is one of the important bioactive molecule reported in Punarnava having various pharmacological activities. It belongs to family of rotenoids, belonging to isoflavone group. Boeravinone B reported to be having major pharmacological activities like anti-cancer, anti-inflammatory, diuretic, and anti-arthritis activity. Production of Boeravinone B from the Punarnava through conventional propagation is comparatively very less. So, modern biotechnological approaches such as cell/tissue culture are employed to produce and increase the accumulation of biomass and the content of Boeravinone B. Callus was induced from leaf explants of Punarnava when inoculated on semi solid MS medium supplemented with various concentrations and combinations of auxins and cytokinins. Along with quantification of Boeravinone B from callus using RP-HPLC, various biochemical assays and anti-oxidant assays were conducted from the methanolic extracts of callus to analyze the efficiency of Punarnava.



## Analysis of Neuroprotective Compound Present in *Eucalyptus citriodora*

Nisha R  
Manjula K.R  
Dr.Shubha  
U.B Roy

REVA University  
Bengaluru, Karnataka.

### Abstract:

Abstract :Neuroprotection refers to preservation of neuronal structure and function. The relative preservation of neurons and integrating it that implies a reduction in the rate of neuronal loss over time. The herbal essential oil extract can be used to in the neuroprotection, majorly *Eucalyptus citriodora* essential oil that can be used in healthy neuroprotection of brain. The *Eucalyptus* oil is the better neurostimulator and effective in treating the symptoms of the neurodegenerative disorders. The plant aroma and the phytoconstituents present in this plant is really beneficiary in curing respiratory symptoms also. The plant is also used in the many ayurvedic treatments for curing brain related diseases also. The *Eucalyptus citriodora* plant also has benefit effects also used in the herbicides spray to avoid the termites. The allelopathic effect of the plant prevents allelopathic symptoms. *Eucalyptus* oil used as disinfectant action, that destroys lower stimulant of life. The main bioactive compound present in the 1, 8-eucalyptus,  $\alpha$ - terpinene-4-ol, and that were the main oxygenated monoterpenes, while  $\alpha$ -eudesmol, citriodora and epilobulol were the main sesquiterpene. *Eucalyptus* oil is used as a stimulant and can be used for antiseptic gargle. Locally applied, it impairs sensibility. It increases cardiac action in the heart. In this study we will focus on the neuroprotective benefits of the plants and the essential oil benefit of the plant.



## Behavioural Analysis of *Drosophila Melanogaster* to Different Stress Models and Identification of Neuroprotective Compounds in the Selected Plants

---

Varsha Rani  
Manjula K.R  
C.S Shivashankar Reddy  
Hanumantappa B Nayaka

REVA University  
Bengaluru, Karnataka.

---

### Abstract:

Neuroprotection is an effect that is effective cause due to salvage recovery or regeneration of the nervous system in cells structure and function there are different neurochemical modulators of nervous system damage. There preservation of neuronal integrity can be caused due to integrity and implies a reduction in the rate of neuronal loss over time which can be expressed as differential equation. *Leucas aspera* plant which is the culinary herb that helps in minimizing the effects of neurodegeneration. *L. aspera* being the common herbal plant and having medicinal property this herb proves to be beneficial role in the neurodegeneration. *Leucas aspera* is reported to have antifungal, prostaglandin inhibitory, antioxidant, antimicrobial, antinociceptive and cytotoxic activities. The plant is used traditionally as an antipyretic and insecticide. It has been touted for being useful in a wide variety of conditions, including cancer prevention, mostly on relatively slim epidemiological evidence, cardiovascular disorders, and AIDS. Neuroprotection refers to relative mechanisms and strategies that shield the central nervous system from neuronal injuries caused by chronic or acute neurodegenerative diseases. With the passage of time, a number of neurotransmitters and signaling molecules have been identified which have been considered as therapeutic targets certain active compounds from medicinal plants play a vital role in maintaining the brain's chemical balance by influencing the function of receptors for the major inhibitory neurotransmitters.



## Catharanthus Roseus and its Extended Benefits

---

Nishtha Singh

Mount Carmel College (Autonomous)  
Bengaluru, Karnataka.

---

### **Abstract:**

Catharanthus roseus, a magnoliophyta is an endangered plant capable of providing medicinal use of wide range. Its also known as Madagascar periwinkle because its native to Madagascar. In Ayurveda as well as modern medicine its uses are extensive such as it can treat Hodgkin's lymphoma diabetes and malaria. This is due to presence of Vinka alkaloids in the plant. it also has two invaluable antitumor terpenoid indole alkaloids, vincristine and vindoline . TIAs are present in micro quantities in the plant and are highly poisonous per se. The main problem that researchers face is getting the most out of these plants because of the small yield . The said paper is completely based upon the various benefits this legendary plant has and all the biochemical pathways we can find out to have an over yield from the plant. The whole idea of over production can also be based upon its self-compatibility and the fact that its unlike the other plants of the species . The plant is also very easy to cultivate and the seed germination period is short which would again help in the yield . The alkaloids separated from the plant also help in the wound excision model in rats. So, in conclusion the pathway if correctly estimated and put in use then we can have a lot of beneficial usage from the the respective plant.



## Comparative Appraisal of *Euphorbia hirta* Leaves and Roots In-Vitro Anti- Inflammatory Activity

---

Amrutha.S  
Paramita Das  
Kuntal Das

Krupanudhi Collage of Pharmacy  
Bengaluru, Karnataka.

---

### Abstract:

The research study was aimed in the comparison of potential in vitro anti-inflammatory activity of *Euphorbia hirta* (EH) leaves and roots. The plant *Euphorbia hirta* family Euphorbiaceae is a pantropical weed, native to India. *E.hirta* active constituents are afzelin(I), quercitrin (II) and myricitrin(III). The phytochemical constituents preliminary screening was carried out for dried leaves and roots extracted with methanolic solvent using Soxhlet method. The results revealed the yield was higher in methanolic root extract compared with the leaves extract. Further, the total flavonoids and phenolics content was higher in methanolic leaves extracts (87.53 mg QE/g and 143.20 mg GAE/g) whereas total alkaloids content was higher in methanolic root extracts (13.01 mg atropine/g). The anti-inflammatory activity of EH was assessed by albumin denaturation, anti-proteinase and anti-lipoxygenase activities. Methanolic leaves extract exhibit significant anti- inflammatory activity ( $p < 0.05$ ) than the root by inhibiting albumin denaturation, anti-proteinase activity, anti-lipoxygenase activity with 87.51% and 51.2% followed by 97.30% and 54.21% followed by 94.43% and 48.21% respectively at 100 $\mu$ g/ml concentration. The result was correlated with the amount of presence of flavonoids and phenolic compounds concluded that both are positively responsible for in-vitro anti- inflammatory activities. Finally, the overall results report that methanolic leaves extracts of EH plant shows better anti- inflammatory activity than root extracts when they are evaluated with three different in-vitro models and the dose dependency activity was recorded.



## Extraction, Phytochemical Screening , HPTLC Analysis and Anti-Oxidant Activity of *Camellia sinensis* (L.) Kuntze

---

Divya.B  
Anitha.S  
Sujani kamble  
Chaithramani B.S

Government College of Pharmacy  
Bengaluru, Karnataka.

---

### Abstract:

Green Tea known as *Camellia sinensis* L. from the family of Theaceae is one of the most consuming aromatic beverages after water for centuries. Green tea is believed to have efficacy as a powerful antioxidant since it contains polyphenols that can reduce free radicals. The aim of this study was to determine the class of chemical compounds of the green tea leaf powder, to evaluate the antioxidant activity of the green tea ethanolic extract with DPPH method. Dried powder was extracted by Soxhlet extraction method using ethanol and followed by the phytochemical screening, HPTLC method was developed for identification of phenolic compounds and to carryout the antioxidant activity test by DPPH method. The ethanolic extract of green tea contained flavonoids, saponins, tannins and steroids / triterpenoids. The extractive yield of *Camellia sinensis* was found to be 21 % .The antioxidant activity assay gave  $86.76 \pm 5.02$  of % inhibition . It can be concluded that the ethanolic extract of green tea has a very strong antioxidant activity. This may be due to presence of phenolic compound which was identified in HPTLC studies . In future the quantification of phenolic compounds can be studied.



## Extraction, Fractionation, Phytochemical Analysis and Evaluation of Anti-Angiogenic Activity of *Artemisia nilagirica*

Eshwar G  
Anitha S  
Sujani kamble  
Chaitramani B S

Government College Of Pharmacy  
Bengaluru, Karnataka.

### Abstract:

*Artemisia nilagirica* is commonly known as the Indian wormwood, family Asteraceae, found in the hilly areas of India. The plant has shown noticeably significant pharmacological activities. **Aim:** Considering the vast potential of traditional healing plants to deliver safer, less toxic and efficient chemotherapeutics so carrying out the methanolic extraction and fractionation with n-Hexane, Chloroform, Ethyl acetate and n-Butanol. The evaluation of the potential bioactive fraction for the anti-angiogenic activity of the *Artemisia nilagirica*. **Methodology:** Fresh plant material of *Artemisia nilagirica* (Clarke) was procured from the Trans-disciplinary university (TDU), dried and ground. The grinded materials was extracted by Soxhlet extraction method using Methanol (MeOH). The Methanolic extract was fractionated into 4 fractions i.e. Hexane (FR1), Chloroform (FR2), Ethyl acetate (FR3) and N-Butanol (FR4), by a standard protocol. The anti-angiogenic activity was evaluated along with control as DMSO and quercetin as positive control. **Results:** The whole plant *Artemisia nilagirica* was authenticated at Regional ayurvedic research institute of metabolic disorders, Bengaluru by the senior botanist Dr. Ramakanth Rao, the Loss on drying value is 8.8% , the total ash value for powdered leaf, flower and stem is 8.5%, 9.55% and 7% respectively, the extractive yield for aerial parts of *Artemisia nilagirica* was found to be 24.4%, Phytochemical screening for aerial parts extracts revealed the presence of alkaloids, flavonoids, terpenoids, phenols, tannins, saponins, volatile oils, Glycosides, the dried methanolic extract taken for liquid-liquid partition was 8g and the yield of hexane, chloroform, ethyl acetate and n-butanol extracts was 1.34g, 1.39g, 1.45g and 1.53g respectively. All the fractions were screened for anti-angiogenic activity. **Conclusion:** To our knowledge, this is our first novel experimentation for Anti-angiogenic activity using different organic solvent extracts of *Artemisia nilagirica* and in future the isolation of the compound may be done for the potential bioactive fractions of *Artemisia nilagirica* to study the anti-angiogenesis, cytotoxicity and chromatographic/spectroscopic methods may use for analysing isolated compound/s.





## Fenugreek as Anticancer Agent

---

Dakka Kusumasree  
Manudevi.S  
Majula K.R

REVA University  
Bengaluru, Karnataka.

---

### **Abstract:**

Phytomedicine is the science of medicine from plants. It plays an important role in improving the immune system in curing of long term diseases like diabetes, cancer, cardiovascular diseases and stroke. Cancer is caused due to uncontrollable cell division that leads to the formation of tumor. Cancer is one of the deadliest disease in the world and it affects over 11 lakh people every year in India alone. Worldwide, more than 10 million people cave in to this disease every year. Cancer can be treated by different ways like surgery, Radiation therapy, Chemotherapy. Of course these can treat but there are long term side effects of cancer treatment. Due to these treatments a person might undergo through many health issues like infections, heart problems, lung problems, dental problems, Brain, spinal cord, and nerve problems, digestion problems etc. Scientists are making their best efforts to fight this cancer; however the sure-shot cure is still awaited. Prevention is better than cure. Though it is the old saying but has great meaning. Ayurveda, the oldest Indian indigenous medicine system of plant drugs is known from very early times for suppressing various tumors using these natural drugs. Commonly used herbal stock reported in Ayurveda are made up of multiple herbs possessing great potential for a cancer cure. Trigonella foenum-graecum also known as Fenugreek is one of the medicinal plants that acts as anticancer agent. Fenugreek acts as anti cancer agent on breast cancer cells, Liver cancer cells etc. This work emphasizes that fenugreek extract is a potential source of anticancer agent.



## Formulation and Evaluation of Polyherbal Toothpowder Using Indian nettle, Coconut spathe, Amla, Tulsi and Others

---

Mamatha A  
Swathi Vijaya P

KLE College of Pharmacy  
Bengaluru, Karnataka.

---

### Abstract:

Dentifrices are necessary for optimum dental health and hygiene in our daily lives. The most serious issues with teeth include gingivitis, plaque, and periodontal disorders. Poor oral hygiene and a lack of attention to tooth care are responsible for these significant difficulties. This negligence promotes plaque growth on teeth, by causing inflammation of gum tissues, which leads to gingivitis and tooth loss. Due to the use of chemicals in most synthetic dentifrice products like toothpowder and toothpaste, adverse effects such as gum irritation, canker sores, burning sensation, and inflammation are caused. In this study, Indian nettle, Coconut spathe, Amla, Tulsi, Black jeera, Turmeric, Clove, Khair, Stevia leaf, Pepper, Camphor, Peppermint, Activated charcoal, and Rocksalt were used to develop herbal toothpowder as an alternative for the users with lesser side effects. In the present work, the herbal toothpowder was formulated and standardized by analyzing necessary evaluation parameters such as organoleptic, physical and phytochemical evaluation of herbal toothpowder.



## Herbal Effervescent Powder For Gastritis Using Shankabhasma, Yashadbhasma , Triphala and others

Mamatha A  
Sagar M  
Pallavi B  
Sharath TP  
Yashwanth S

KLE College of Pharmacy  
Bengaluru, Karnataka.

### Abstract:

Gastritis is defined as inflammation of the gastric mucosa. In histological terms, it is distinguishable into two categories, i.e Non-Atropic and Atropic. There are several etiological types of gastritis, their different etiology being related to different clinical manifestations and pathological features. Atropic gastritis (resulting mainly from long standing *Helicobacter pylori* infections) is a major risk factor for the onset of gastric cancer (intestinal type). Also gastric medications are prescribed in combination with antibiotics, to suppress their adverse effects. Even though we have many allopathic drugs to treat the condition they have their own concern. As an alternative to this, Anti -gastric Herbal formulations can be given which can be safer. The effervescent Anti-gastric Herbal powder is a type of bulk powder containing the herbal ingredients, citric acid and sodium bi carbonate which helps in reducing the gastritis in a better way, as the effervescent powder is distributed evenly and the bioavailability is comparatively higher. Hence, an attempt is made to formulate a polyherbal effervescent powder for gastritis using Shankabhasma, Yasadbhasama, Triphala, Ginger, Moringa, Pudina, turmeric, Khajoor, Pipali, Ajamooda, Black pepper, black salt, sodium bi carbonate, citric acid and tartaric acid. Shankabhasma is a great acid neutralizer that helps in lowering hyperacid secretions in the stomach and aids in balancing the acid production. The formulated polyherbal effervescent powder for gastritis is evaluated for organoleptic, physical and phytochemical parameters. The prepared polyherbal effervescent Powder for Gastritis was found to be satisfactory.



## Modelling Intracerebral Haemorrhage in Adult Zebrafish to Study Neuromodulatory Effects of Asiaticoside

---

Madhan Kumar Srinivasan  
Lalitha Vaidyanathan

Sri Ramachandra Institute of Higher  
Education And Research  
Chennai, Tamil Nadu.

---

### Abstract:

The etiology of stroke can be classified as hemorrhagic or ischemic. Although hemorrhagic type is less prominent than the other, they cause nearly 30% of all the stroke-related deaths worldwide. So, there is a dire need for elucidation of the complete pathophysiology of the intracerebral hemorrhage (ICH) and its secondary consequences. The demand for potential therapeutic agents that can alleviate the symptoms and improve quality of life in patients with ICH is growing up. Several phytochemicals capable of such potency with minimal adverse effects can replace drugs in market. This requires large scale screening and *in vivo* experimental demonstration of the potency in ICH models that simulate mammalian pathophysiology. In the present study, Atorvastatin induced ICH model of adult Zebrafish is used to investigate the iron chelation and neuromodulatory effects of a triterpenoid Asiaticoside extracted from the plant *Centella Asiatica* to develop new therapeutic strategies for management of ICH. Neuro inflammation and iron accumulation are the major pathophysiological abnormalities after ICH that delay the restoration of normal function of the damaged brain tissue. The study is designed to check if Asiaticoside has iron-chelating property and anti-inflammatory effects that could lessen the ferroptosis rate in the brain tissue. The iron accumulation and infiltration of the inflammatory cells in the brain tissue of adult Zebrafish ICH model followed by the treatment with asiaticoside would be assessed to reveal the neuroprotective role of asiaticoside in ICH.



## Pharmacognostical Analysis of *Nigella sativa*.

---

Mamatha A  
Durgashree M D

KLE College of Pharmacy  
Bengaluru, Karnataka.

---

### **Abstract:**

Plants are a wonderful creation of nature, that produces chemical substances which have become an important source of drugs. Chemical substances are mainly classified as alkaloids, flavonoids, glycosides, phenolics, and tannins. Plants for their medicinal values are used for Traditional medicines, Nutraceuticals, Modern medicines, and food supplements. Medicinal plants contribute a source of substance for the treatment and prevention of human diseases. *Nigella sativa* is one of the widely used plants for its medicinal values. It is used in the treatment of diabetes and traditionally for promoting and nourishing hair growth. In this present study, an attempt is made to analyze the seeds of *Nigella sativa*. The morphological study, microscopical studies (powder microscopy, and Transverse section) were performed. Followed by Physicochemical analysis such as Moisture content, Total ash, water-soluble ash, acid-insoluble ash, and extractive value. Extraction was carried out using various solvents such as Petroleum ether, Ethyl acetate, and Methanol. Obtained extracts were identified using Thin-layer Chromatographic Technique. Methanolic extract of *Nigella sativa* seeds gave a high extractive yield and the active compound Thymoquinone, which has anti-diabetic property. Thus, methanolic extract can be used in the future for Anti-diabetic formulations.



## Pharmacognostical, Phytochemical Evaluation and Development of HPTLC Profiles of *Equisetum hyemale* L

Harini L  
Sujani V Kamble  
Anitha S  
Chaitramani BS

Government College of Pharmacy

### Abstract:

Pharmacognostical characters were evaluated both morphologically by visual inspection and microscopically. Methods: The stems of *Equisetum hyemale* has been collected and authenticated by Central Ayurveda Research Institute. The successive extraction was carried out using petroleum ether, chloroform, ethyl acetate, methanol, 50% ethanol and extractive yield were recorded, the physical parameters such as ash value, moisture content, and extractive values were carried out and values were recorded, the phytochemical screening of all the 5 extracts were performed and HPTLC analysis silica gel 60-F254 plates with 5–6  $\mu\text{m}$  particles for HPTLC (Merck®) were used for analysis. The samples were applied using a semi-automatic apparatus (Linomat V, Camag®) controlled by Wincats® software (Camag®). 2 $\mu\text{l}$  of both standard and sample(5mg/ml) were applied in bands of 8mm in width. The chromatograms were developed in a twin trough vertical glass chamber (20 cm  $\times$  10 cm, Camag®) after saturation for 30min with the mobile phase 4:1:5 (n Butanol: acetic acid: water v/v/v). After this process the plate was scanned for the spots at 254nm. Calibration curve of standard Quercetine: 10milligram of reference standard of Quercetine was dissolved in 10ml of methanol to yield stock solution of 1mg/ml solution. 5 ml of stock solution was diluted to 50 ml to give 100 $\mu\text{g}/\text{ml}$  concentration. Further the stock solution was diluted to give 2 $\mu\text{g}/\text{ml}$ , 4 $\mu\text{g}/\text{ml}$ , 6 $\mu\text{g}/\text{ml}$ , 8 $\mu\text{g}/\text{ml}$ , 10 $\mu\text{g}/\text{ml}$  concentration. Results and Discussion: The extractive yield of *Equisetum hyemale* was found to be petroleum ether (2.889% w/w), chloroform (0.9119% w/w), ethyl acetate (1.1164% w/w), methanol (8.4815% w/w), 50% ethanol (3.6673% w/w). Proximate values: Moisture content (9.6041% w/w), Alcohol soluble extractive value (10.4928% w/w), water soluble extractive value (15.97% w/w), total ash (19.71% w/w), water soluble ash (2.358% w/w), acid insoluble ash (9.7854% w/w). In Phytochemical screening of extracts triterpenes, phytosterols, were reported in petroleum ether, methanolic extract, and 50%ethanolic extracts saponins were reported in methanolic and 50% ethanolic extract and flavonoids, carbohydrates and protiens and amino acids were reported in methanolic extract, and 50% ethanolic extract. HPTLC for flavonoids conformed presence of Quercetin and Rf values of standard and sample were found to be 0.34. Conclusion: Pharmacognostical and phytochemical analysis of *Equisetum hyemale* revealed a set of parameters, which may enable to those who handle this plant to maintain its quality control. The physical parameters, such as loss on drying, ash values and extractive values will be helpful to identify the authenticity of the drug even after the crushed or powdered plant materials. The extractive values are useful during time of extraction. The ash value was found to be high, which indicates presence of inorganic material like silica as per literature review. Phytochemical screening revealed the presence of secondary metabolites. HPTLC profiles for flavonoids in methanolic and 50% ethanolic extract has been evaluated.



## Phenolic Composition and Antioxidant Potential of *Cosmostigma cordatum*

Asima Das  
Mayuri Mishra  
Juhi Puthukulangara Jaison  
Joseph Kadanthottu Sebastian

CHRIST (Deemed to be University)  
Bengaluru, Karnataka.

### Abstract:

*Cosmostigma cordatum* (Poir.) M.R. Almeida, a plant belonging to the family Apocynaceae, has not been explored plants for its phytochemistry and antioxidant properties. The species of this family are known for their various medicinal and antioxidant properties. This is a preliminary study. Materials and methods: Dried samples were used to estimate the proximate and mineral composition. Distilled water, methanol, and ethanol extracts were analyzed for the quantification of phenolic compounds and antioxidant potential. EC<sub>50</sub> values were determined to estimate the antioxidant potential. Results: Leaves of *Cosmostigma cordatum* (Poir.) M.R. Almeida was found to be a good source of proximate contents and minerals. Total phenols, flavonoids, minerals, and antioxidant activity of methanolic, ethanolic, and aqueous extracts were obtained from the leaves were determined. Extracts showed a higher concentration of phenols ( $2.29 \pm 0.06$  mg GAE g<sup>-1</sup>) in methanolic extracts and these extracts have higher antioxidant activity when compared to ethanol and aqueous extracts. The flavonoid content was found to be higher in ethanolic extracts ( $51.94 \pm 0.89$  mg QE g<sup>-1</sup>) when compared to other extracts. In addition, Gas chromatography- mass spectroscopy analysis of the hexane extract of leaves identified seven volatile compounds such as (E, E)-7,11,15-Trimethyl-3-methylene-hexadeca-1,6,10,14-tetraene, 1H-Cycloprop[e]azulene, decahydro-1,1,7-trimethyl-4-methylene-, n-Hexadecanoic acid, 1-Naphthalenepropanol, .alpha-ethenyldecahydro-2-hydroxy-.alpha.2,5,5,8apentamethyl-[1R-[1.alpha.(R\*).beta.4a.beta.8a.alpha.]]-, Cis-3,14-Clerodadien-13-ol, Squalene and Octacosane. Conclusion: Our results suggest that the leaves can become a potential source of food supplement, nutraceutical, and photo-therapeutics



## Phytochemical analysis and HPTLC identification of phyto-constituents of *Salacia chinensis* L. collected from two different geographical sources

Pooja Prasad A  
Anitha S  
Sujani Kamble  
Chaitramani B S

Government College of Pharmacy  
Bengaluru, Karnataka.

### Abstract:

**Background:** *Salacia chinensis* L. family of Hippocrateaceae commonly known as Saptarangi in Hindi is a woody climbing shrub, widely distributed in the western ghats of India. Different organs of the plant have shown number of activities like antidiabetic, anti-inflammatory, antitumor, cardiac disorders, antioxidant, tonic, blood purifier and anticancer property has been identified. Therapeutic protective nature of the phyto-constituents majorly mangiferin in diabetes treatment could be through decreasing oxidative stress and protecting pancreatic  $\beta$ -cell damage. The phenotype of the plant plays a major role in the concentration of the primary and secondary metabolite production and hence the therapeutic efficacy. **Aim and Objective:** To carry out the preliminary phytochemical screening of the methanolic stem extracts of *S.chinensis* collected from two different geographical locations. To compare the secondary metabolite production (mangiferin) in the plants (stem) collected from two different geographical locations and the  $\alpha$ - amylase inhibitory activity of the methanolic stem extract of the plants. **Methods:** *S.chinensis* stem was collected from two different geographical locations namely Indian Institute of Horticultural Research (IIHR), Bangalore and Kakkayam froest, Kerala and authenticated at Regional Ayurvedic Research Institute For Metabolic Disorders (RARI), Bangalore. The morphological, microscopical and physico-chemical evaluation of the stem of *S. chinensis* is carried out. The methanolic extract of *S. chinensis* stem from various sources were obtained by continuous hot percolation (soxhlet extraction). To this extract phytochemical screening, TLC identification, HPTLC analysis is carried out. Mangiferin content is quantified in different sources and the  $\alpha$ - amylase inhibitory activity of all the extracts is evaluated. **Results:** the extractive yield of methanolic stem extract of *S.chinensis* (Bangalore and kerala) was found to be 7.348% w/w, and 13.420% respectively. The proximate analysis show that the stem extract (IIHR, Bangalore) contains appreciable percentage of moisture ( $9.38 \pm 0.51$ ), ash value ( $1.5 \pm 0.25$ ), water extractive value ( $6.2 \pm 0.81$ ), alcohol extractive value ( $9.89 \pm 0.34$ ). Bioactive compounds analysis of *S.chinensis* showed the presence of alkaloids, tannins, saponins, flavonoids, glycosides, terpenoids, proteins and carbohydrates in the plants collected from both the regions (IIHR, Bangalore & kakkayam, kerala). The mangiferin content was quantified in the plants collected from different regions and their  $\alpha$ - amylase inhibitory activity was carried out for comparison. **Conclusion:** the present study was taken up to quantify the secondary metabolites in the plants collected from different regions and to evaluate its  $\alpha$ - amylase inhibitory activity. In future these compounds may be responsible to cure diabetes which is very much required globally.





## Phytochemical Analysis of Purple Flower Extract (*Pongamia pinnata*) and its Antimicrobial Activity

---

Deepak Kumar J  
Bhavya Shree M  
Abhilash K  
Adinath N Tavanappanavar  
Sikandar I. Mulla

REVA University  
Bengaluru, Karnataka

---

### Abstract:

*Pongamia pinnata* is considered as one of the important plants because of its ayurvedic properties. In this study, we have collected Purple flower (*Pongamia pinnata*) and extracted using alcoholic heat reflux. Phytochemical analysis results showed reducing sugar, alkaloids, steroids, flavonoids, saponins, tannins tests showed positive. Furthermore, we have done antimicrobial activity test and we are synthesized Ag nanoparticles using alcoholic extract.



## Phytochemical Screening and Assessment of Anti-Oxidant and Anti-Mitotic Activity of Floral Pigments from *Callistephus chinensis*

---

Korru Jyothsna]

Thatti Silpa

Venkata Prasad K R

Adinath N Tavanappanavar,

Sikandar I. Mulla

---

St. Aloysius College,

Mangalore, Karnataka.

### Abstract:

**Background:** In India approximately 80,000 tonnes of flower waste are produced every year. This is an issue of concern, due to which the application of flower waste in various fields is the need of the hour. Flower extracts have antioxidant, antimicrobial, cytotoxic and antigenotoxic effect. **Objectives:** The current study aims to utilize *Callistephus chinensis* (temple flower) floral waste to extract bioactive pigments using different extraction procedures and assess the anti-mitotic, anti-oxidant activity of the extract. **Methodology:** The extraction was carried out using three methods i.e., ultrasonication, aqueous extraction and methanolic extraction. Methanolic extract was screened for phytochemicals. In addition, the quantitative analysis was done to estimate the total phenolic content. The extract was characterized by UV-vis spectrophotometry and FTIR. The anti-oxidant property of the flower waste extract was assessed by the FRSA method. The antimitotic activity was assessed by using *Allium cepa* root meristematic cells. **Results:** Among the three extraction procedures, the methanolic extraction procedure proved to be the most effective. Qualitative phytochemical analysis revealed the presence of flavonoids, cardiac glycosides, saponins, terpenoids, phenolics and carbohydrates. The total phenolic content of the extract was found to be 198.54 mg GAE/g extract. The UV-vis spectrophotometry results indicated the presence of anthocyanins and was confirmed by FTIR spectral analysis. The scavenging activity of the extract showed increase when compared to standard. A decrease in the mitotic index of the *Allium cepa* model on application of the extract was observed. This shows that the floral pigments contained antimitotic agents. **Conclusion:** The methanolic flower waste extract of *Callistephus chinensis* possesses significant number of phytochemicals which exhibit anti-mitotic activity indicating the cytotoxic potential of the flower extract. The high free radical scavenging activity of the extract was due to the presence of anthocyanins.



## Phytochemical Screening and TLC Identity of *Sonchus asper* L Hill

Shweta P

Anitha S

Mr. Praveen M J

Sujani kamble, Chaitramani B S

Government College of Pharmacy  
Bangalore, Karnataka.

### Abstract:

*Sonchus asper* L. hill. (Asteraceae) is an annual or biennial herb reaching a height of 200 cm. with spiny leaves and yellow flowers resembling those of the dandelion. The leaves are bluish-green, simple, lanceolate, wavy and lobed margins, covered with spines on both the sides. The base of the leaf surrounds the stem. The leaves and stems emit a milky sap when cut. One plant will produce several flat-topped arrays of flower heads, each head containing numerous yellow ray flowers but no disc flowers. The aerial part *Sonchus asper* L Hill has been collected and authenticated by Central Ayurveda Research Institute. The aerial part *Sonchus asper* L Hill was dried, powdered and extracted successively using different solvents based on polarity. The successive extraction was carried out using n-hexane, ethyl acetate, methanol, water and extractive value were recorded. Phytochemical screening all the extracts were performed. The result part includes the presence of fats and oil, tannins in N-hexane were reported. In ethyl acetate extract proteins, steroids, alkaloids, tannins were reported. In methanolic extract glycosides, flavonoids, were reported. In aqueous extract carbohydrates, saponins, flavonoids were reported. Study revealed the presence of vital secondary metabolites which possess the therapeutic significance. It is a nutraceutical herb hence in future we can use as nutrient by proving its antifatigue activity.



## Preparation and Characterization of Nano Formulation and Evaluation of Antilithiatic Activity of *Colocasia esculenta* Tubers

Soujanya S  
Sujani Kamble  
Anitha S  
Chaitramani B S

Government College of Pharmacy  
Bengaluru, Karnataka.

### Abstract:

**Background:** Lithiasis is a condition where urinary calculus is formed in the kidney. Kidney stone are growing global problem. Nanotechnology is a promising technique to increase the bioavailability and stability of drugs herbal medicine. *Colocasia esculenta* lin [family: Araceae] is popularly known as “Taro”. It is herbaceous perennial plant. **Aim and objectives:** To synthesize and characterize the nanoparticles with *Colocasia esculenta* tuber extract and evaluate its effect against antilithiatic activity. **Method:** The tubers of *Colocasia esculenta* was collected and authenticated from Regional Ayurveda Research Institute For Metabolic Disorders ,Bengaluru. The dried tuber powder was extracted by Soxhlet extraction method with methanol as solvent. The obtained CEE was subjected for phytochemical screening using standard procedures. It was found to have various phytochemicals like carbohydrate, alkaloid, flavonoids etc., The synthesized nanoparticles will be subjected for particle size analysis and characterized by various spectroscopical analysis. he synthesized nanoparticles were evaluated for antilithiatic activity by nucleation assay method. **Result & discussion:** The preliminary phytochemical study revealed the presence of different phytochemicals in CEE. It confirms the presence of alkaloid, flavonoids, carbohydrates, tannins, glycosides, terpenoids and saponin. The extract was subjected for invitro antilithiatic activity hence it significantly reduced crystal nucleation at concentration of 2,4,8 and 10 mg/ml. **Conclusion:** From the above study, we found that the methanolic extract of CE tuber had significant effects on nucleation assay. The extract showed a good inhibitory effect on the CaOx crystallization. After synthesizing the nanoparticles, the nanoparticles may also show the significant antilithiatic activity.



## Herbal Effervescent Powder for Gastritis Using Shankabhasma, Yashadbhasma, Triphala and Others

---

Mamatha A  
Sagar M  
Pallavi B  
Sharath TP  
Yashwanth S

KLE College of Pharmacy  
Bengaluru, Karnataka.

---

### Abstract:

Gastritis is defined as inflammation of the gastric mucosa. In histological terms, it is distinguishable into two categories, i.e Non-Atropic and Atropic. There are several etiological types of gastritis, their different etiology being related to different clinical manifestations and pathological features. Atropic gastritis (resulting mainly from long standing *Helicobacter pylori* infections) is a major risk factor for the onset of gastric cancer (intestinal type). Also gastric medications are prescribed in combination with antibiotics, to suppress their adverse effects. Even though we have many allopathic drugs to treat the condition they have their own concern. As an alternative to this, Anti -gastric Herbal formulations can be given which can be safer. The effervescent Anti-gastric Herbal powder is a type of bulk powder containing the herbal ingredients, citric acid and sodium bi carbonate which helps in reducing the gastritis in a better way, as the effervescent powder is distributed evenly and the bioavailability is comparatively higher. Hence, an attempt is made to formulate a polyherbal effervescent powder for gastritis using Shankabhasma, Yasadbhasama, Triphala, Ginger, Moringa, Pudina, turmeric, Khajoor, Pipali, Ajamooda, Black pepper, black salt, sodium bi carbonate, citric acid and tartaric acid. Shankabhasma is a great acid neutralizer that helps in lowering hyperacid secretions in the stomach and aids in balancing the acid production. The formulated polyherbal effervescent powder for gastritis is evaluated for organoleptic, physical and phytochemical parameters.



## Physicochemical Analysis of Methanolic Leaf Extract of *Saraca asoca* (Roxb)

---

Mubasheera MG  
Mamatha  
Hariprasad

KLE college of Pharmacy  
Bengaluru, Karnataka.

---

### Abstract:

Herbal drugs play an important role in health care system especially in developing countries like India. Ancient Indian literature incorporates a remarkably broad definition of medicinal plants and considers 'all 'plant parts to be potential sources of medicinal resource. Ayurveda is a traditional system of medicine in which herbal therapies are used systematically. Ashoka i.e. *Saraca asoca* (Roxb.) Wilde belonging to Caesalpinaceae subfamily of the Legume is one of the indigenous plants with lots of traditional significance. All parts of this plant are considered pharmacologically important and has especially been used to manage various gynecological disorders like menorrhagia, leucorrhoea, dysfunctional uterine bleeding. *Saraca asoca* has been reported to contain phytoconstituents like flavonoids, steroids, glycosides, saponins, tannins, carbohydrates, proteins along with lot of pharmacological activities such as anti diabetic , anti cancer, spasmogenic, oxytocic, uterotonic, anti-bacterial, anti-menorrhagic, anti-cancer, anti-esterogenic, anti-progestational, dermatoprotective, anti-mutagenic and genoprotective activities. Ayurvedic texts describe more than 50 preparations of Asoka for the treatment of a variety of ailments. Hence, an attempt is made to study the physicochemical parameters of methanolic leave extract of *Saraca asoca*.



## GC-MS and FTIR Analysis of the Flower Extract of *Pseuderanthemum carruthersii* (Seem.) Guillaumin

---

Bhavyashree S  
G Nayana  
Ramesh BS  
B.S .Jyothsna

Nrupathunga University  
Bengaluru, Karnataka

---

### Abstract:

The dried powder of flowers of *Pseuderanthemum carruthersii* (Seem.) Guillaumin were extracted with methanol, chloroform and ethyl acetate. The crude extracts were subjected to identify the various functional groups through FTIR studies and various bioactive compounds by GC-MS analysis. FTIR studies indicates the presence of various functional groups that were recorded in different peaks. Flower extract analysis revealed the existence of twenty eight phytochemical compounds. Some major bioactive compounds obtained from methanol, chloroform and ethyl acetate extracts are 4 – Hydroxy – Beta – Ionone, Butylated hydroxytoluene, 3 – Acetoxydodecane, 1 – Heptatriacotanol, Dotriacontane, 2, 3 – Anhydro – D- Galactosan. N-nadecane, 1-chloro-, Dotriacontane, Heptacosane, Tetratriacontane, 1-Bromoeicosane and Heneicosane, Sulfurous acid, Pentadecyl 2- Propyl ester, and Ethyl acetate. These findings support the traditional use of *P.carruthersii* in various ailments. Further studies are needed to isolate active compounds of the extract.



## Herbal Effervescent Powder for Gastritis Using Shankha Bhasma Yashad Bhasma

Mamtha  
Pallavi,sagar  
Yashwanth,  
Sharath

KLE College Of Pharmacy  
Bengaluru, Karnataka.

### Abstract:

Gastritis is defined as inflammation of the gastric mucosa. In histological terms, it is distinguishable into two categories, i.e Non-Atropic and Atropic. There are several etiological types of gastritis, their different etiology being related to different clinical manifestations and pathological features. Atropic gastritis (resulting mainly from long standing *Helicobacter pylori* infections) is a major risk factor for the onset of gastric cancer (intestinal type). Also gastric medications are prescribed in combination with antibiotics, to suppress their adverse effects. Even though we have many allopathic drugs to treat the condition they have their own concern. As an alternative to this, Anti -gastric Herbal formulations can be given which can be safer. The effervescent Anti-gastric Herbal powder is a type of bulk powder containing the herbal ingredients, citric acid and sodium bi carbonate which helps in reducing the gastritis in a better way, as the effervescent powder is distributed evenly and the bioavailability is comparatively higher. Hence, an attempt is made to formulate a polyherbal effervescent powder for gastritis using Shankabhasma, Yasadbhasama, Triphala, Ginger, Moringa, Pudina, turmeric, Khajoor, Pipali, Ajamooda, Black pepper, black salt, sodium bi carbonate, citric acid and tartaric acid. Shankabhasma is a great acid neutralizer that helps in lowering hyperacid secretions in the stomach and aids in balancing the acid production. The formulated polyherbal effervescent powder for gastritis is evaluated for organoleptic, physical and phytochemical parameters. The prepared polyherbal effervescent Powder for Gastritis was found to be satisfactory.





# **Bioinformatics Approach to Phyto-Medicine**



## Pharmacophore Based Screening to Identify Natural Products Targeting RIF-R Mycobacterium tuberculosis

Madhana Priya.N  
Thirumal Kumar.D  
Magesh.R

Sri Ramachandra Institute of Higher  
Education and Research  
Porur, Chennai.

### Abstract:

Tuberculosis, caused by the bacterium *Mycobacterium tuberculosis* (MTB), is still a major source of illness and mortality in underdeveloped nations. The spread of drug-resistant TB is a major concern to world health. Mutations in *rpoB*, the beta subunit of MTB's DNA-directed RNA polymerase (PDB ID: 6DVC), has been identified as a key source of RIF resistance. Traditional phytomedicine is a rich source for modern target-specific way to identify promising lead compounds using structure-based drug discovery approach. **Objectives:** To identify potent small molecules using high-throughput virtual screening against Rifampicin (RIF) resistant M.tb from Natural Compound Libraries. **Methodology:** In this study, two resistant mutants of *rpoB* (K148A & S149A) based on the evolutionary conservation was modeled using Schrodinger. Further, docking analysis with natural compounds in addition to RIF was done using the Glide. Subsequently, this was verified by molecular dynamics simulations. **Results:** The docking results revealed that asn:98397 more effectively inhibited the wild-type *rpoB* (-9.8kcal/mol) and *rpoB* mutants (K148S: -10.05 kcal/mol & S149A: -9.254 kcal/mol) whereas RIF had low inhibition activity (Native: -0.935 kcal/mol, K148S: -1.34 kcal/mol & S149A: -1.23 kcal/mol). The *rpoB* structures interacted with RIF with very low binding energy, revealing the incapableness of RIF inhibition and thus showing resistance. This in silico evidence may help us overcome RIF resistance in *rpoB* mutant strains. **Conclusion:** The identified phytocompound can behave as an alternative to RIF and overcome resistance. There is an urgent need to identify lead phytocompounds as alternate therapeutics for multidrug resistant M.tb and In silico speeds up the process.



## Drug Likeliness and Molecular Docking Studies to Explore Anticancerous Potential of *Acalypha indica*

---

Asma Saqib  
Farzana Tasneem MI  
Sajeeda Niketh

Maharani Cluster University  
Bengaluru, Karnataka.

---

### Abstract:

Cancer is a disease in which some of the cells grow uncontrollably and spread to other parts of the body. Cancer is the second leading cause of death in India and worldwide. Although great advancements have been made in the treatment and control of cancer progression, significant number of undesired side effects sometimes occurs during chemotherapy and room for improvement remains. Medicinal herbs and their phytochemicals are being increasingly recognized as useful complementary treatments for cancer. The herb *Acalypha indica* which belongs to Euphorbiaceae family has multiple medicinal properties which include anti-fungal, anti-bacterial, anti-oxidant, anti-inflammatory, anti-helminthic, anti-ulcer, anti-venom, anti-cancerous, and neuro-protective activity. The aim of present study is to investigate the anticancerous activity of *Acalypha indica* using molecular docking and Swiss ADME/T tools. This study suggested that  $\gamma$ -sitosterol acetate,  $\beta$ -sitosterol acetate, and  $\gamma$ -sitosterol might be able to induce caspases, thereby activating apoptosis. These high-affinity compounds can bind to caspase-3 more efficiently and were able to stabilize the protein. Therefore, the bioactives of *Acalypha indica* have the potential to be used as lead compounds in the treatment of cancer.



## In Silico Evaluation Of The Binding Mechanism Of *Rhododendron arboreum* Bioactives Against Catechol-O-Methyltransferase in Parkinson Disease

---

Devangna Paul  
Myrene Roselyn D'souza

Mount Carmel College  
Bengaluru, Karnataka.

---

### Abstract:

Parkinson's disease (PD), the second most prevalent neurodegenerative disease affecting individuals in their 5th-6th decade of life, still does not have any cure. Even the golden therapy for PD like L-DOPA has its switch-on and off effects manifesting over continuous use. Thus arises the need for potential drug molecules, that assist in reducing the progression of neurodegeneration. The enzyme catechol-o-methyltransferase (COMT), involved in the metabolism of L-DOPA and DOPA is one of the targets of PD pathogenesis. Although there are three clinically prescribed COMT inhibitors available, only one traverses the blood brain barrier (BBB) but also exhibits high hepatotoxicity. This makes it imperative to search for alternative molecules with comparative therapeutic effect, lipophilicity, and low toxicity. The *Rhododendron* family is known to have neuroprotective potential but very little is known about the specie *Rhododendron arboreum* and its therapeutic effect on PD. In this study, we report in silico docking according to the Lamarckian algorithm principle, inhibition constant, binding energy, and ADMET studies on 12 selected phytochemicals, followed by molecular docking with respect to COMT to determine their potential inhibitory effects compared to commercial drugs. However, further in vitro, and in vivo studies are required for the clinical development of novel therapeutic drugs.



## In Silico Screening of Phytochemicals as a Potential Drug for Leprosy

---

Ananya Joliholi  
Lokesh Ravi

Department of Botany,  
St. Joseph's College (Autonomous)  
Bengaluru, Karnataka.

---

### Abstract:

The main objective of this paper is to make an attempt to screen a large database of phytochemicals against “Enoyl-acyl carrier protein reductase” drug target of *Mycobacterium leprae* to identify a potential inhibitor and drug to treat the disease caused by it, Leprosy and to identify a better treatment with lesser side effects than the existing one. Leprosy is a bacterial disease caused by *M. leprae*, mostly seen in developing countries like India and Africa. It is characterized by disfiguration of arms and legs due to skin infections, it can also cause nerve damage. Enoyl-acyl carrier protein reductase is a pivotal bacterial protein which is involved in the mycolic acid biosynthesis, which is one of the most important metabolic pathways in *M. leprae*. Phytochemicals from 300 medicinal plants were retrieved using Dr. Duke's Phytochemical and Ethnobotanical Databases and these were screened for in-silico toxicity using PyRX server, out of these 300 plants, 2 plants contained phytochemicals with the best binding affinities. Coagulin C, isolated from the plant *Withania coagulans* exhibited a binding energy of -9.9Kcal whereas Withametelin isolated from *Datura metel* showed a binding energy of -9.8Kcal. As a result these ligands could be used as a potential inhibitors of the protein Enoyl-acyl carrier protein reductase, which could help us curb the infection of the new antibiotic resistant form of leprosy.



## Regulatory Effect of Flavanoids Againsts the Transforming Growth Factor - Beta1 Gene Causing Oral Submucous Fibrosis

---

Nithya Rathinam  
Madhana Priya N  
Magesh R

Sri Ramachandra Institute of Higher  
Education and Research  
Chennai, Tamil Nadu.

---

### Abstract:

Oral submucous fibrosis (OSMF) is categorized by the increased production and decreased degradation of collagen. It is a precancerous condition that in 1.5-15 percent of instances develops into a malignant tumour. Chewing of betel nut remains the major risk factor associated with OSMF. Currently, OSMF is treated using Pentoxifylline and Hyaluronidase which are associated with various side effects. This study aims to identify a potent natural compound against the signalling pathway of TGF $\beta$ 1 gene to improve the OSMF condition. Initially, 3035 flavanoid compounds were retrieved from seleckchem database and screened for the best binding compounds using PyRx software. The top 3 compounds from the screening results were subjected to toxicity ADME study which subsequently result in 1 compound (obacunone) to follow the Lipinski rule. Finally, docking study was performed for Obacunone and the existing drugs Pentoxifylline and Hyaluronidase resulting the binding score of -7.7kcal/mol, -4.8kcal/mol and -4.9kcal/mol respectively. Therefore, we conclude Obacunone to be a better treatment option to suppress the action of TGF $\beta$ 1 in order to inhibit OSMF.



## Selection of Phytochemicals from *Calendula Officinalis* : Potent Inhibitor of *Streptococcus iniae*

Shatakshi Mishra  
B Stany, Suma K  
Bhoomika V  
Lokesh Ravi

Department of Botany,  
St. Joseph's College (Autonomous)  
Bengaluru, Karnataka.

### Abstract:

This paper aims at providing a hypothesis for the treatment of golf ball disease of the aquatic species, caused by the pathogenic strain, *Streptococcus iniae*. The hypothesis is provided by using previously done works against the pathogen worldwide as a reference. Various bioinformatics tools, webservers and software were used in order to complete the task, which include, DrugBank Online | Database for Drug and Drug Target Info, BLAST (uniprot.org), Protein BLAST: search protein databases using a protein query (nih.gov), <https://swissmodel.expasy.org/>, <https://phytochem.nal.usda.gov/phytochem/search>, PubChem (nih.gov), RCSB PDB: Homepage, PyRx software and PyMOL. Five drug targets were selected namely, Bifunctional protein Glmu, Superoxide dismutase, CCA adding enzyme, enolase, CTP synthase exhibiting 96.92%, 96.85%, 94.08%, 92.76% and 94.63% of the Ramachandran favoured regions respectively. Highest binding affinity was observed to be -9.9 Kcal/mol, by Trigonelloside C with Superoxide dismutase, -10 Kcal/mol by Auroxanthin with Bifunctional protein Glmu, -9.8 Kcal/mol by Quercetin-3-O-glucoside-7-o-rhamnoside with CCA adding enzyme, -11.2 Kcal/mol by Saponin with Enolase, -11.1 Kcal/mol by Pinoresinol with CTP Synthase. According to the data documented and tabulated in the paper and the study conducted concludes that the plant *Calendula officinalis* can be preferred as a treatment option against the golf ball disease caused by *Streptococcus iniae* in the fishes.



## To Decipher The Natural Compound Activity Against SLC17A5 Protein Causing Free Sialic Acid Storage Disorders: A Computational Approach

Priyanka K  
Madhanapriya N  
Magesh R

Sri Ramachandra Institute of Higher  
Education and Research  
Chennai, Tamil Nadu.

### Abstract:

Free sialic acid storage disorders belong to a larger group of diseases known as lysosomal storage disorders. A transport protein known as sialin leads to the abnormal accumulation of free sialic acid in the tissues of affected individuals. Infantile free sialic acid storage disease (ISSD) is usually apparent at birth or early in infancy; some infants may be born prematurely. Affected infants may also fail to gain weight, Cognitive deficits and seizures may occur. The SLC17A5 gene contains instructions for producing a protein called sialin that is required to transport free sialic acid from inside lysosomes. There is no specific treatment for ISSD. Treatment is directed toward the specific symptoms that are apparent in each individual. Seizures are treated by generally accepted standards such as the use of anticonvulsants. **Methodology** : In-silico tools were used to study the evolutionary, pathogenicity, stability, biophysical screening analysis for the pathogenic variants of SLC17A5 protein. Molecular docking to analyze the interaction profile of protein and ligand molecule using AutoDock software. **Result And Discussion** : This study was initiated to identify the most significant variant through various computational pipelines. Initially, a total of Nine variants responsible for Infantile free sialic acid storage disease (ISSD) from NCBI, HGMD, and UniProt databases with 329 amino acid length were retrieved and further scrutinized by standard computational tools (Conservational analysis, Pathogenicity prediction, Biophysical function, Stability analysis). P334R was selected according to the binding site and sequentially significant mutation from the above tools. A structure-based analysis was done to understand the interaction profile and the drug (Ellipticine: a natural compound was targeted as an anti-convulsant to treat seizures in ISSD individual) by utilizing Molecular docking analysis (AutoDock). **CONCLUSION**: With an overview of literature study, a computational pipeline was initiated to detect the most significant mutation responsible for Infantile free sialic acid storage disease (ISSD). This study assists in understanding the most pathogenic mutant, the Ellipticine activity was identified by its interaction profile with the mutation (P334R) and paves the way to help in better drug base treatments for ISSD individuals were there's no specific treatment up to date.





## In-Silico Studies of Traditional Medicinal Plants Against Hepatitis B

Nikhil K  
Paramita Das  
Preethi K  
Oviya P

Krupanidhi College Of Pharmacy  
Bengaluru, Karnataka.

### Abstract:

Acute and chronic hepatitis is caused by the hepatitis B virus (HBV), which leads to liver cirrhosis. The mortality rate is about 33.33% in chronic conditions. Several synthetic treatments are available which can reduce the risk of liver damage but cannot cure hepatitis B. So, medicinal plants have to be used due to their vast number of therapeutic properties and are less toxic effects. The main aim of this work is to determine the activity of medicinal plants against hepatitis B. About 10 medicinal plants were selected for their activity against hepatitis B. A protein from HBsAg (PDB ID: 6VJT) and HB core Ag (PDB ID: 3OX8) are selected for in-silico studies. Among all the medicinal plant constituents selected, 7 showed better activity, and 3 showed moderate activity compared to standard tenofovir. Ganoderic acid and isorhamnetin showed binding energy of -6.84 Kcal/mol and -6.96 Kcal/mol with 3OX8; -6.94 Kcal/mol and -5.42 Kcal/mol with 6VJT. Lys, Arg, Gln, and Ser are the major residues for interaction. Pharmacokinetic studies of the ligands were performed which showed a better activity compared to standard. These chemical constituents are further developed for hepatitis B treatment.



## In Silico Screening of Phytochemicals as a Potent Treatment Drug for Viral induced Liver Cirrhosis

---

P Nidhin Rajan  
Lokesh Ravi

Department of Botany,  
St. Joseph's College (Autonomous)  
Bengaluru, Karnataka.

---

### Abstract:

The aim of this study is to screen a selected group of plants for possible phytochemicals that can be a potential drug for Hepatitis C Virus induced liver cirrhosis in human beings. The need for an HCV vaccine is to be addressed but the high number of strain variants of HCV makes the process cumbersome. So the need for development of newer drugs should be a top priority which can not only the infection but also is non-toxic towards the liver and associating organs. So the preference was given to naturally obtained phytochemicals from plants which were scarcely studied. The phytochemicals curated from 120 different plants with the help of Dr. Duke's database were made to undergo docking using Auto-dock Vina in which the protein NS3-4A protease was the drug target to find its suitable inhibitors. Extensive help from databases Uniprot, PDB, Swiss modelling has been a driving force to complete this process. Among the phytochemicals tested for their inhibitory properties of the viral protein, Hypericin exhibited significant results, inhibiting with a binding energy of -8.3kcal/mol respectively. Hence, by homology modelling and protein ligand docking methods, Hypericin is proposed to be a potential target drug for Hepatitis C induced liver cirrhosis. Further studies have to be carried out for proving the efficiency of these phytochemicals in vivo.



## In Silico Screening of Potent Drug Targets for Attention Deficit Hyperactivity Disorder (ADHD)

---

Ganesh Desai  
Lokesh Ravi

Department of Botany,  
St. Joseph's College (Autonomous)  
Bengaluru, Karnataka.

---

### **Abstract:**

Attention-deficit/hyperactivity disorder (ADHD) is a neurodevelopmental disorder that affects attention and behavior, and primarily affects children and adolescents. Effective management of ADHD is necessary for children and adolescents and may include non-pharmacologic treatments, pharmacologic therapy including use of stimulant and non-stimulant medications, or a combination of the different treatment modalities. This study aims to identify potentially therapeutic phytochemical ligands that may effectively treat or alleviate the symptoms of the disorder and this was accomplished through protein-ligand docking where the homology structure prediction for NET-P23975, was elucidated using Google DeepMind AlphaFold-2, an artificial intelligence program.



## Potential Plant Drugs Against *Edwardsiella tarda* By Protien Ligand Docking

Bhargav Y  
Rownak Patel  
Sushmitha S  
Lokesh Ravi

Department of Botany,  
St. Joseph's College (Autonomous)  
Bengaluru, Karnataka.

### Abstract:

*Edwardsiella tarda* infection (Edwardsiellosis) is considered as a dangerous septicaemic disease affecting cultured fishes and leading to high economic losses. Outbreaks of this infection constitutes a major constrain on aquaculture production of catfishes and even pose health risks to humans, causing gastroenteritis, meningitis, liver and skin abscesses. This study aims to identify ethnobotanical plants and their phytochemicals which can be used in the treatment of “edwardsiellosis”. We gathered information regarding the drug targets of the bacteria *Edwardsiella tarda* and concluded that Transcriptional regulator sly A, Glyceraldehyde 3 phosphate Dehydrogenase and GroEL protein were suitable targets for this study. A homology model was constructed using the amino acid sequence (FASTA format) of the drug target proteins. After an analysis of the Ramachandran plot and Ramachandran favoured region, the best suited models were selected for the process of Protein ligand docking. A total of 60 different ethnobotanical plants were listed and the 1102 phytochemical ingredients of these plants were retrieved from varying databases. We used the PyRx tool to perform Protein-Ligand docking. Energy minimization of selected ligands was done using the in-built Open Bable software. Virtual screening of drug targets against ligands was done using AutodockVinasoftware. Docking was then performed against all 1102 ligands against the respective drug target proteins. PyMOL was used to visualize the interactions between the Protein-Ligand complex. The results showed the phytochemicals Tara Tanin and Xyloglucan Heptsaccharide, present in *Althaea officinalis* and *Astragalus membranaceus* to have the most significant inhibition potential against their respective drug targets. We conclude that the plant *Althaea officinalis* and *Astragalus membranaceus* can be used as a potential drug against *Edwardsiella tarda*.



## Predicting a Potential Phytochemical Drug for Treating Enteric Red Mouth Disease, Caused By *Yersinia Ruckeri*, In Salmon Fish

---

Sayantani Chowdhury  
Akanksha Mandal  
Siddharth Sen  
Vaarruni S  
Ankitha Ajith  
Lokesh Ravi

---

Department of Botany,  
St. Joseph's College (Autonomous)  
Bengaluru, Karnataka.

### Abstract:

Enteric redmouth disease (ERM) or yersiniosis is a common and very serious septicemic disease caused by bacteria found in salmonid fish species, which is caused by *Yersinia ruckeri*. *Yersinia ruckeri*, a gram-negative rod-shaped enterobacterium- has a wide host range and geographical distribution that also causes major economic losses in the pisciculture industry. In this study, the main focus was to find plant phytochemicals that could be used as potential antibiotics for the drug target protein taken (in this scenario, Tol B, superoxide dismutase, PPIases, YopO, and Serralysin(metalloprotease)). Early on in this study, we found out the Ramachandran favored region percentage which came out as Tol B was 99%, the drug target protein superoxide dismutase, was found to be 96.83%, while drug target protein YopO, was found to be 96.61%, for drug target protein PPIases was found to be 96.69%, and last but not the least the drug target protein serralysin(metalloprotease), was found to be 97.64%. After the conclusion of the Ramachandran favored region, we conducted docking with 1102 energy minimized ligands in Pyrx application by matching the structure with the homology model of our chosen drug targets. At last, the study concluded with the plant *Calendula officinalis* surfacing in all of our results as the common plant which could be used for the treatment and research of yersiniosis with having the highest negative binding energy of -13.1 Kcal/mol in Tol B out of all the drug targets used. The plant (*Calendula officinalis*), should further be examined in-vitro to justify the given hypothesis.



## Screening and Identification of Phytochemicals with Potent Calcineurin Inhibitor Activity

---

Sidharth Kumar N  
Sumathy Arockiasamy  
Udhaya Lavinya B

Sri Ramachandra Institute Of Higher  
Education And Research  
Chennai, Tamil Nadu.

---

### Abstract:

**Background:** Drug-induced nephrotoxicity is of serious concern as it contributes to both acute and chronic kidney disease. Tacrolimus, a calcineurin inhibitor, is a widely used immunosuppressive agent that minimizes organ rejection in post-transplant patients. However, the drug is also known for its nephrotoxic effects. **Objectives:** Current study is aimed at identifying a natural compound with significant calcineurin inhibitory potential. The study involves in silico screening of 40 chosen phytochemicals for calcineurin inhibitor potential. **Methodology:** Calcineurin (PDB ID: 4OR9) was prepared for docking and active site prediction was carried out. 40 phytochemicals(PC1-PC40) with known antioxidant and anti-inflammatory properties were chosen for the study. The physicochemical properties and toxicity of the ligands were computed using SwissADME, ProTox-II and macle. The ligands were docked with 4OR9 at the active site using AutoDock Vina. The protein was also subjected to docking with the control ligand tacrolimus. The docked complexes were visualized on PyMol and the results of docking experiments were analyzed. **Result:** PC1 was found to possess better binding efficiency with the protein 4OR9 with a binding energy of -6.314kcal/mol when compared with -4.062kcal/mol for Tacrolimus. **Conclusion:** The compound PC1 was found to be a potent calcineurin inhibitor by in silico methods. In future, molecular dynamics can be done to further explore the efficacy of the drug to be used as therapeutic agent.



## *Veratrum viride* as a Potential Therapeutic Agent for the Treatment of Bovine Babesiosis

---

Vaibhavi Kulkarni  
Preetha Murali  
Dhruthi K S  
Dhanyatha Suresh  
Lokesh Ravi

---

Department of Botany,  
St. Joseph's College (Autonomous)  
Bengaluru, Karnataka.

### **Abstract:**

This study aims to find a suitable plant drug source against the causal organism of Bovine Babesiosis, *Babesia bigemina*. The protozoon *Babesia bigemina* was picked due to the drastic effects it has on the health of dairy cows and young calves. Furthermore, not many in-depth works regarding the plants and the disease explored in this study were found, up to date. The selected drug target molecules were homology modelled via the SwissModel server, to ensure accuracy and minimization of errors in the following steps. Ramachandran plots were used to evaluate the suitability of the proteins, with all homology models exhibiting a score of more than 95% in the Ramachandran favoured regions. Around 1,102 secondary metabolites derived from 60 ethnobotanical plants were subjected to autodocking, using the Autodock Vina software in the Pyrx application on each of the target molecules. The results indicated Jervine, produced by *Veratrum viride* has the highest binding potential to two of the drug targets, by demonstrating low binding energy of -10.7 Kcal/mol and -10.1 Kcal/mol. Multiple phytochemicals produced by the plant *Calendula officinalis* also showed significant binding potentials to the drug target; with Luteoxanthin having the lowest binding energy of -11.1Kcal/mol. Therefore, through the docking analysis of various secondary metabolites, it was concluded that *Veratrum viride* and *Calendula officinalis* can be used for the treatment of Bovine Babesiosis, as the synergistic effects of the phytochemicals produced by these plants could efficiently inhibit the functions of the drug targets.



# Developing an Artificial Neural Network Based Global Model to Predict Stomatal Responses of Versatile Medicinal Tree Species In Mitigating Drought Induced Physiological Stress

---

Sivakannan Subramani  
Nithaniyal Stalin  
Francis Densil Raj V

Department of Big Data Analytics  
St. Joseph's College (Autonomous)  
Bengaluru, Karnataka

---

## Abstract:

Climate change is a major global concern that induces physiological stress in tree species in temperate and tropical biomes. Excessive heat and drought stress directly alter the morphology, physiology, biochemical, & molecular responses in plants. This will lead to a decline in the canopy size, leaf senescence, loss of photosynthetic potential and degradation of chlorophyll pigments, ultimately affecting the forest productivity. However, the trees make use of the Stomatal closure as one of the unique mechanisms to mitigate drought-induced physiological stress. Knowledge of stomatal regulation in different trees is essential to improve our understanding on stomatal sensitivity in diverse environmental conditions. Therefore, Machine Learning (ML) approaches based on modelling are used to predict the stomatal response to climate variables and species traits. The current study aimed to develop an Artificial Neural Network (ANN) model to capture multiple tree species' stomatal responses. To achieve this, we assembled a large dataset obtained from the earlier studies that included measurements of climate variables and species traits for 3698 samples representing 36 species from 5 forest biomes belonging to 6 continents to increase the versatility of the model. In this study, ANN models were created, and the models were generated with different hidden layers and various neurons in the hidden layers. The performance, correlation coefficient and simulation of each model were measured. Different ANN models show promising results in modelling plant responses to changes in climate. ML based studies will be useful to predict the optimal condition of stomatal response in regulating the drought stress. Thus the study could be helpful to improve forest productivity by understanding the stomatal regulation of each tree against the stress.





## In Silico Screening of Phytochemicals as Potent Treatment Drug for Huntington's Disease

---

Prashanth M  
Ajith Kumar  
Lokesh Ravi

Department of Botany  
St. Joseph's College (Autonomous)  
Bengaluru, Karnataka

---

### Abstract:

The main purpose of this paper is to make an attempt to screen a large data base of phytochemicals against “G protein-coupled receptors 52 (GPR52)” drug target of huntington disease to identify a potential inhibitor and drug to treat the disease and to identify an effective treatment for the same. Huntington's disease (HD) is autosomal dominant disorder identified by the progressive decline of motor, cognitive, and psychiatric functions. HD results from mutation that causes a trinucleotide CAG repeat expansion and the production of mutant Huntingtin protein (mHTT). Usually, juvenile HD results in death within 10 years after symptoms develop GPR52 is activated by antipsychotics reserpine leading to an increase in intracellular cAMP. Proteasomal degradation of mHTT is enhanced via inactivation of the small GTPase Rab39B. Therefore, targeting Gpr52 by an antagonist considerably lowers mHTT and rescues Huntington's disease phenotypes ; it was chosen as the target protein for Homology modelling and Docking study. Methods: Phytochemicals from 300 medicinal plants were retrieved using Dr. Duke's Phytochemical and Ethnobotanical Databases and these were screened for in-silico toxicity using PyRX server, of which two phytochemicals out of 300 showed best binding affinity with the receptor protein and the two phytochemicals were Oolonghomobisflavan B and Sequoiaflavone found particularly in *Camellia sinensis* and *taxus baccata*. The phytochemicals were docked using the tool vina wizard in the PyRx server. Results: Oolonghomobisflavan B and Sequoiaflavone gave better binding affinity with -12.9 Kcal/mol and -12.5 Kcal/mol. Conclusion: As a result, these ligands could be a natural inhibitor against Huntington's disease, and the study thus demonstrates the importance of natural product-based therapeutic options for the same.



## Discovery Of Potential HPV 16 E6 Protein Inhibitors Through Virtual Screening

Vemula Vani  
Sanjay Prasad  
Nikita Paul  
Nithya G  
Pooja N  
Pooja V

Department of Botany  
St. Joseph's College (Autonomous)  
Bengaluru, Karnataka

### Abstract:

Human papillomavirus (HPV) infection is one of the most common sexually transmitted diseases. The current treatment methods consist of the use of chemotherapeutic agents or the application of surgical procedures to remove the developed tumors. The alternatives to treat HPV-associated diseases is the discovery of accessible drug-based therapies. In HPV infected cell, E6 protein complexes with E6AP to form p53 degradation complex and induce tumorigenesis. The objective of this study is to discover potential small molecule inhibitors against HPV16 E6 protein using virtual screening approach. Three novel HPV 16 E6 inhibitors viz, compound 5, compound 7 and compound 10 were designed using a fragment-based approach. The structural information of these three novel compounds was used in virtual screening against in- trials subset of ZINC database and a total of 9800 hits were identified. The obtained molecules from the database were further screened by three stages of virtual screening using GLIDE module of Schrodinger software. The results reveal that Five hit molecules (ZINCO00034853956, ZINCO0001534965, ZINC000095617673, ZINC000005764481 and ZINC000071606215) showed better glide score in comparison with reference molecule, Luteolin. These molecules exhibited crucial interactions with E6 protein of HPV 16. The pharmacokinetic properties of these hit molecules were analyzed using QikProp program. The results indicate that all the five molecules were found to have good pharmacokinetic properties and human oral absorption. All the five hit molecules were predicted to be no toxic and except ZINC000005764481, all other four molecules showed druglike behavior. Therefore, the four hit molecules (ZINC000034853956, ZINC000001534965, ZINC000095617673 and ZINC000071606215) can be used as lead molecules in the development of HPV 16 E6 inhibitors for treatment of HPV related diseases.



# Phyto-Chemistry in Nanotechnology



## Biosynthesis of Nanoparticles from Medicinal plants and Study of their Applications

---

Muktha H  
Annesha Roy  
Harshitha Raj I B  
Amulya M D

Department of Biotechnology,  
M S Ramaiah College Of Arts, Science  
And Commerce, Bengaluru, Karnataka

---

### Abstract:

Medicinal plants are gaining immense importance in the recent years due to their healing properties. Biosynthesis of nanoparticles from medicinal plants is considered to be the most effective approach as the material possess unique dual properties. Using plant materials makes the process more environmentally friendly, less toxic, and cheaper. Biosynthesis method can be used to produce different type of nanoparticles like silver nanoparticle, cobalt nanoparticle, titanium dioxide nanoparticle and gold nanoparticle is carried out using different parts of Madagascar periwinkle plant extract. It is a ready-to-use plant known to have antibacterial, antifungal, antioxidant, antibiotic, and anticancer properties. Nanotechnology has brought research breakthroughs in a variety of industrial applications. Among these, it has reached prominent levels in medicine such as bio diagnosis, drug delivery and cancer treatment. Nanomedicine is an interaction between the field of nanotechnology and medicine, involving the development of new therapeutic and diagnostic modality using precisely designed nanoscale materials. Nanoparticles are nanoscale-sized particles that exhibit new properties such as high surface-area-to-volume ratio and excellent optical, physical, and chemical properties. These particles find advantages in the drug delivery area and overcome the limitations of most traditional particles. *Catharantus roseus* (Periwinkle or Sadabahar) is a traditionally used medicinal plant of the Apocynaceae family. Also known as *Lochnera rosea*, *Ammocallis rosea*, *Vincarosea*. It is found in all tropical or subtropical regions of the world. Various phytochemical studies of *C. roseus* have been reported in the literature and its extracts are known to have antiviral, antibacterial, antioxidant, and antifungal activity. Alkaloids are considered the major chemical constituents of this plant.



## Evaluation of Potential Larvicidal and Pupicidal Activity of *Cassia fistula* L. Synthesized Silver Nanoparticles Against *Aedes aegypti*

---

Jincy A. George  
Dr. Paari K A

Christ (Deemed to be University),  
Bengaluru, Karnataka

---

### Abstract:

Diseases such as malaria, dengue, brain fever, etc. that are fatal to humans is caused by small vectors such as mosquitoes. Its various species inhabits various viruses that is spread into the human system upon biting. Dengue fever (DF) and dengue hemorrhagic fever (DHF) is carried and spread by *Aedes aegypti*. Control measures against this disease-causing vector has still not seen day light. Nanotechnology is a growing field of research that has been extensively studied to use nanosized particles to target diseases. The fatality of the DF and DHF has alarmed a need for development of promising methods to control *Aedes aegypti*. Our research is designed to synthesize silver nanoparticles from *Cassia fistula* leaf extract. The leaf extract prepared by Soxhlet was characterized by phytochemical analysis and GC-MS analysis to confirm the presence biological metabolites such as alkanes, esters, phenols etc. that can act as reducing agents. The metabolites thus formed helps in reducing the silver nitrate metal ions to silver nanoparticles ( $Ag^+$  to  $Ag^0$ ). The synthesized silver nanoparticles are confirmed using analytical techniques such as FTIR, XRD, SEM, EDAX and Zeta potential. The synthesized silver nanoparticles are subjected to study its capability in larvicidal and pupicidal activity against the first four larval stages and pupal stage of *Aedes aegypti*. The Lethal concentration (LC50) values were calculated using the probit analysis in SPSS statistical tool. The *Cassia fistula* synthesized nanoparticle has been proved for its lethality against the stages of *Aedes aegypti*.



## Green Synthesis of Cerium Oxide Nanoparticles Using *Pandanus amaryllifolius* Leaf Extract and Their Evaluated Biological Application

---

B. Dharani  
K. Gopinath  
K. X. Antu  
PR. Kaleeswarran  
A. Arumugam

---

Department of Nanoscience and  
Technology  
Alagappa University, Karaikudi.

### Abstract:

Green synthesis of nanoparticles has been gaining recognition due to its eco-friendly nature and cost-effectiveness. The present study investigated the green synthesis of CeO<sub>2</sub> NPs using *Pandanus amaryllifolius* leaf extract and their biogenic applications. The green synthesized CeO<sub>2</sub> NPs characterized by UV-Vis-DRS, ATR-FT-IR, XRD, Raman, PL, EPR, SEM with EDX, and TEM analysis. In UV-Vis-DRS analysis of absorbance spectrum of CeO<sub>2</sub> NPs showed at 302 nm and calculated optical band gap at 2.9 eV. The ATR-FT-IR spectrum of *P. amaryllifolius* leaf extract showed the active functional groups responsible for CeO<sub>2</sub> NPs formation. XRD patterns showed well crystalline planes at (111), (200), (220), and (311) of CeO<sub>2</sub> NPs, which corresponded to the face-centered cubic structure with an average crystalline size of 32 nm. The SEM and TEM images of CeO<sub>2</sub> NPs exhibit a spherical shape ranging from 20 to 50 nm. The different content of CeO<sub>2</sub> NPs tested for antimicrobial, hemolysis, cytotoxicity, and seed germination activities. Overall activities are dependent on the increase with an increase in the content of CeO<sub>2</sub> NPs. Hence, CeO<sub>2</sub> NPs can be used for food, biosensor, cosmetics, biomedical and paramedical-related application.



## Green synthesis of Tin Oxide Nanoparticles Using *Prunus dulcis* Gum: A Humidity Sensor and Antibacterial Applications

C. Balalakshmi  
G. Meenu Pragathi  
A. Shakthi Sowmiya  
K. Gopinath

Department of Nanoscience and  
Technology  
Alagappa University, Karaikudi.

### Abstract:

Nanotechnology has become the most promising area of research with its momentous application in all fields of science. In recent years, tin oxide has received tremendous attention due to its fascinating properties, which have been improved with the synthesis of this material in the nanometer range. The present work synthesized Tin oxide nanoparticles (SnO<sub>2</sub> NPs) using *Prunus dulcis* gum by the green method. The synthesized as-prepared sample was calcined at 800 °C, and this sample was characterized by the UV-vis (UV-visible Spectrometer), Fourier-Transform Infrared (FTIR), X-Ray Diffraction (XRD), Scanning Electron Microscopy (SEM), Energy Dispersive X-Ray Spectroscopy (EDX), and Transmission Electron Microscope (TEM) analysis. The UV-vis absorption spectrum of SnO<sub>2</sub> NPs showed two intense absorption bands at 320 and 480 nm. XRD patterns revealed well crystalline planes at (110), (101), (200), (211), (220), (310), (301), and (321), which are well-matched with JCPDS card No: 41-1445. SEM images of SnO<sub>2</sub> NPs exhibited the rod-like structure, and EDX peaks showed strong signals of element Sn (66.41%) and O (33.59%) weight percentages confirming the formation of SnO<sub>2</sub> NPs. The elemental mapping image of red and green colors revealed the presence of elements in oxygen and tin in the synthesized SnO<sub>2</sub> NPs. The TEM images of SnO<sub>2</sub> NPs showed a rod shape of 700-1300 nm. The humidity sensor study of the SnO<sub>2</sub> NPs measured at different humidity atmosphere (RH 5% to RH 98%). In addition, the response and recovery time and the sensitivity factor *S<sub>f</sub>* were calculated. The synthesized SnO<sub>2</sub> NPs tested against Gram-positive (*Staphylococcus aureus*) and Gram-negative (*Escherichia coli*) bacterial strains. The antibacterial effect revealed an increase with the increase in the concentration of SnO<sub>2</sub> NPs. However, SnO<sub>2</sub> NPs can be used for catalyst, biomedical, energy-saving, anti-static, and anti-reflection coatings.



## Synthesis of CdS by *Pongamia pinnata* Flower Extract and its Antimicrobial Activity

---

Korru Jyothsna]

Thatti Silpa

Venkata Prasad K R

Adinath N Tavanappanavar,

Sikandar I. Mulla

---

REVA University,  
Bengaluru, Karnataka.

### Abstract:

Recently, nanomaterials are gaining more popularity due their small in size (nanoscale dimension), which can easily use for various purpose. In this work we have used *Pongamia pinnata* flower and aqueous extract was carried out via microwave assisted extraction method. Phytochemical analysis results showed reducing sugars, alkaloids, steroids, flavonoids and saponin tests showed positive whereas tannis test was showed negative. Furthermore, we have done antibacterial activity and we are synthesized CdS nanoparticles using aqueous extract of *Pongamia pinnata* flower.





## Green Synthesis of Nanoparticles from *Punica granatum* L., a Plant with Rich Phytochemical and Pharmacological Potential

---

Chole Pranjali B

Christ (Deemed to be) University,  
Bengaluru, Karnataka.

---

### Abstract:

*Punica granatum* L. (Pomegranate) is a fruiting plant belongs to the Lythraceae family. Pomegranate is native to Iran and Himalayan regions and commonly cultivated for its fruit. It is well known plant in traditional Ayurvedic medicinal system. Scientific and ethno-botanical studies suggest that pomegranate have potential antioxidant, anticancer, anti-diabetic, anti-inflammation, and antimicrobial activities. Green synthesis of nanoparticles from various parts of the medicinal plant helped in improved system of drug delivery. In this study, we tried to focus on the nutritional, phytochemical constituents and pharmaceutical potential of edible and non-edible part of pomegranate and also on green synthesis of nanoparticles from seed oil of pomegranate.



## Photocatalytic Degradation Of Crystal Violet Using *Quassia indica* (Gaertn.) Leaf Extract

---

Shilpa Susan Scaria  
Joseph K S

REVA University,  
Bengaluru, Karnataka

---

### Abstract:

Synthesis of nanoparticles (NPs) by means of plant extracts has been proposed as an environmentally approachable substitute for the chemical synthesis of NPs. In the current study, silver nanoparticles (AgNPs) were synthesized using a simple and cost-effective technique by *Quassia indica* leaf extract. The UV-Vis absorption spectrum of the reduced reaction mixture exhibited the surface plasmon peak at 429.50 nm. The physicochemical characterization of the optimized NPs was done by Fourier transform infrared spectroscopy (FTIR). The average crystallite size of the AgNPs was determined by Scherrer's formula and found to be 8.145 nm. The photocatalytic degradation of crystal violet dye was carried out under UV light irradiation, and the degradation efficiency of the reaction was calculated to be around 80-90%.



# Natural Products Against Covid



## Seaweeds: A Rational Approach Towards Covid-19 Receptor-Binding Domain Via Molecular Docking Studies

---

Preethi K  
Paramita Das  
Nikhil K  
Shravani K

Krupanidhi College Of Pharmacy,  
Bengaluru, Karnataka

---

### Abstract:

COVID-19 (SARS-CoV-2) has been one of the most widespread diseases in recent times leading to an increase in the mortality rate. There are various types of research going on for COVID but there is no actual treatment. An alternative form of prevention and treatment includes nutraceuticals. The scope of seaweeds in research and discovery is very less. Seaweeds are the chief component in food, medicine, and fertilizer in the majority of East Asian countries. Seaweeds possess a low toxic effect and are available at minimum cost. In this study, chemical constituents from 10 different seaweeds are selected. Molecular docking is carried out between proteins of SARS-CoV-2 and chemical constituents of seaweeds. The results are compared with Remdesivir. Among all the chemical constituents of the seaweeds Siphonaxanthin, Carrageenan, Phlorotannin A, Catechin, Alginic acid, and Atropine showed better binding affinity and interaction than Remdesivir. Phlorotannin and atropine showed binding energy of -6.42 Kcal/mol and -7.32 Kcal/mol with 7BZ5; -6.27 Kcal/mol and -6.35 Kcal/mol with 6LZG respectively. ADMET studies were performed which showed a better absorption and less toxicity of the selected drugs. Further, the phytoconstituents with good results can be used for developing COVID-19 drugs.



## Symptomatic Treatment of COVID Infection Using the *Plectranthus amboinicus* Extract

---

Lalitha M C  
Sneha B M  
Manjula

REVA University,  
Bengaluru, Karnataka.

---

### Abstract:

Ayurveda is based on natural science and so all ayurvedic remedies are close to nature. Ayurvedic medicines make use of natural herbs, extracts and plants. One of the advantages of natural products over allopathy is that the herbs and plants that it uses do not have side effects that mimic allopathic medicines. Allopathic medicine is made in labs and every allopathic medicine comes with side effects that can range from mild to severe. By using natural products, this is not the case because all the remedies are naturally made with natural ingredients that don't cause devastating effects on your health. *Plectranthus amboinicus* is a semi succulent perennial with a pungent oregano-like flavour and order. This plant is the main ingredient which is used to treat the patient who is facing cough and throat pain which are the main symptoms of covid. Black cumin, pepper, turmeric, bay leaf, ginger, *Plectranthus amboinicus*, salt cardamom are the main ingredients hence we have used natural products to treat covid which helps the immune system to protect against viruses and diseases and to kill pathogens. This review presents the immune system from the protection of the human body against covid. This illustrates the process of immune system and how it works to fight viruses, presents the information on the most recent covid treatment and various types of potential challenges for the immune system are discussed. Adequate nutrition intake is the main factor to strengthen immunity. The aim is to present the immunity to human body by natural phyto-constituents against covid 19.



# Genomics & Proteomics of Phytomedicine



## Molecular Characterization of In-Vitro Propagated Plants of *Aerva lanata* (L.)Juss. ex Schult. using RAPD Markers

---

Nagaveni. C  
Dr. L. Rajanna

Bangalore University,  
Bengaluru, Karnataka

---

### Abstract:

Antihyperglycaemic, lithotriptic, urolithic, antibiotic, antihelminthic, antihyperlipidemic, anti-microbial and hepatoprotective properties of *Aerva lanata* (L.) Juss. ex Schultz, a medicinally important herbal plant intrigued our interest in studying and propagating this plant. As the plant displayed challenges in propagation by conventional methods, especially during the off-season, we opted for the in-vitro multiplication method. This present study is to establish the genetic similarities and differences between the somaclonal variants obtained by in-vitro propagation. Specific markers such as OPA 13, OPB 10, OPB-11 and OPD-02 were used and one particular variant showed a significant difference from the wild and other somaclonal counterparts. This variant is said to have developed epigenetic variation due to induced mutagenesis. The RAPD analysis was carried out to prove this, and we believe the obtained results are novel and substantial.



## Application of DNA Barcode as an Authentication Tool to Differentiate Highly Traded Ayurvedic Drug *Centella asiatica* (L.) Urb. from its Adulterants

---

Kruthika P  
Mishael Leona Noronha  
Stalin Nithaniyal

Department of Botany,  
St. Joseph's College (Autonomous)  
Bengaluru, Karnataka.

---

### Abstract:

*Centella asiatica* (L.) Urb. is considered sacred in India and is known as the Brahmi herb in Ayurveda for its ability to awaken spiritual ability. The herb has been considered as brain tonic due to its broad beneficial neuroprotective activity and to treat a variety of conditions including fever, anxiety, scleroderma, fatigue, asthma, epilepsy and skin disease. Due to an increase in trade demand, there is an increase in species adulteration in commercial products. Our analysis of chemical properties showed that the species of *Centella asiatica* has compounds belonging to terpenes such asiatic acid, madecassic acid, asiaticoside, madecassoside, whereas the potential adulterant species such as *Merremia emarginata* and *Hydrocotyl vulgaris* has different metabolites profile. Adulterant species at small amounts acts as stimulant while in large doses as narcotic causing stupor, vertigo and coma. Therefore, we have employed in-silico analysis of DNA barcodes to differentiate the authentic species from the adulterant species. We used 70 DNA barcodes belonging to *rbcL*, *matK*, *trnH-psbA* and *ITS2* markers retrieved from GenBank database. When comparing authentic species (*Centella asiatica*) with adulterant species (*Hydrocotyl vulgaris*) it showed 11% divergence with *matK* followed by *ITS2* (8%) and *rbcL* (4%). We are also testing the traded powdered products using DNA barcodes and the results will be discussed. Our study reinforces that DNA barcode could be used as a rapid authentication tool to monitor the trade of Ayurvedic drugs since consumption of adulterated species in large amounts can lead to undesirable side effects or sometimes can be fatal.





## Phytocine'22 Schedule

### Event Schedule : Day 1 (20.05.2022)

<b>9.00am to 10.00am</b>	<b>Inauguration</b>
	Prayer
	Introduction to conference by <b>Dr. Lokesh Ravi</b>
	Welcome Address by <b>Dr. Jayarama Reddy</b>
	Presidential Address by <b>Dr. Fr. S. Xavier, SJ</b>
	Keynote Address by <b>Dr. P. Sathiyarajeswaran (Director, AYUSH) - Chief Guest</b>
<b>10.30am to 11.30am</b>	<p><b><u>Lead Lecture</u></b></p> <p><b>Dr. Kannabiran Krishnan</b> (VIT, India)  <i>Bacterial secondary metabolites (Natural Products) in targeting fish bacterial pathogens for effective control and management of fish bacterial diseases</i></p>
<b>11.30am to 1.00pm</b>	Paper Presentation Session 1
<b>1.00pm to 2.00pm</b>	<p><b><u>Lead Lecture</u></b></p> <p><b>Dr. Mohanasrinivasan V</b> (VIT, India)  <i>Plant cells as bioreactors for novel phytomedicine production</i></p>
<b>2.00pm to 3.00pm</b>	<p><b><u>Lead Lecture</u></b></p> <p><b>Dr. Karthik L</b> (Salem Microbes, India)  <i>Kabasura Kudineer -A Treasure for SARS-CoV-2 Treatment</i></p>
<b>3.00pm to 4.00pm</b>	Paper Presentation Session 2
<b>4.00pm to 5.00pm</b>	<p><b><u>Lead Lecture</u></b></p> <p><b>Dr. Sudhakaran R</b> (VIT, India)  <i>Journey of medicinal herb based drug derivation for protection against white spot syndrome virus in shrimp</i></p>
<b>5.00pm to 6.00pm</b>	Paper Presentation Session 3

\* Poster Presentation will be conducted in parallel sessions



## Phytocine'22 Schedule

### Event Schedule: Day 2 (21.05.2022)

9.00am to 10.00am	<p style="text-align: center;"><b><u>Lead Lecture</u></b></p> <p style="text-align: center;"><b>Dr. John Adams S</b> (Mississippi, USA) <i>Herbs: problems &amp; quality standards</i></p>
10.00am to 11.30am	Paper Presentation Session 4
11.30am to 12.30am	<p style="text-align: center;"><b><u>Lead Lecture</u></b></p> <p style="text-align: center;"><b>Dr. Sailendra Singh</b> (Migal Galilee Research Institute, Israel) <i>Agrobacterium rhizogenes - A "natural genetic engineer" for production of pharmaceutically active phytomedicines via Hairy Root Technology</i></p>
12.30am to 1.30pm	Paper Presentation Session 5
1.30pm to 2.00pm	<p style="text-align: center;"><b><u>Guest Talk</u></b></p> <p style="text-align: center;"><b>Dr. Govind Pratap Rao</b> (MP Journals, India)</p>
2.00pm to 3.00pm	<p style="text-align: center;"><b><u>Lead Lecture</u></b></p> <p style="text-align: center;"><b>Dr. Kasi Gopinath</b> (BeiBei, China) <i>Advances in Nanotechnology Application for Plant Development and Biological Treatment</i></p>
3.00pm to 4.00pm	Paper Presentation Session 6
4.00pm to 5.00pm	Paper Presentation Session 7
5.00pm to 6.00pm	<b>Valedictory Function</b>
	Conference Report by <b>Dr. Lokesh Ravi</b>
	Valedictory Speech by <b>Fr. Denzil E. Lobo, SJ</b>
	<b>Vote of Thanks</b>

\* Poster Presentation will be conducted in parallel sessions



## Phytocine'22 Report

The conference was successfully executed with participations from 24 different institutions around the country, with more than 150+ participants. The conference had lead lectures of scientists and faculties of reputed institutions from 4 different countries.

First day Inauguration Program began at 9.00am on 20<sup>th</sup> May 2022, with Prayer Songs, followed by Introduction to the Conference by Dr Lokesh Ravi. Welcome Address was given by Dr. Jayarama Reddy, Head of Department of Botany, SJC. Presidential Address was given by Dr. Fr. S. Xavier, SJ. Keynote address was delivered by the Chief Guest, Dr. P. Sathiyarajeswaran, Director of Siddha Research Centre, AYUSH. The Inauguration Program was concluded and followed by Lead Lectures, Oral Presentation, Poster Presentation and Debate events as per schedule. Day one events were concluded at 6.00pm.

Second day of the conference began at 9.00am on 21<sup>st</sup> May 2022, with a Lead Lecture. Followed by Oral Presentations, Poster Presentations and Quiz events as per schedule. The Valedictory Function began at 5.00pm on 21<sup>st</sup> May 2022 with Conference Report presented by Dr Lokesh Ravi, followed by Valedictory Speech by Fr. Denzil E. Lobo, SJ. Vote of Thanks was presented by Dr. Nithaniyal Stalin. The conference was concluded at 6.00pm on 21<sup>st</sup> May 2022.

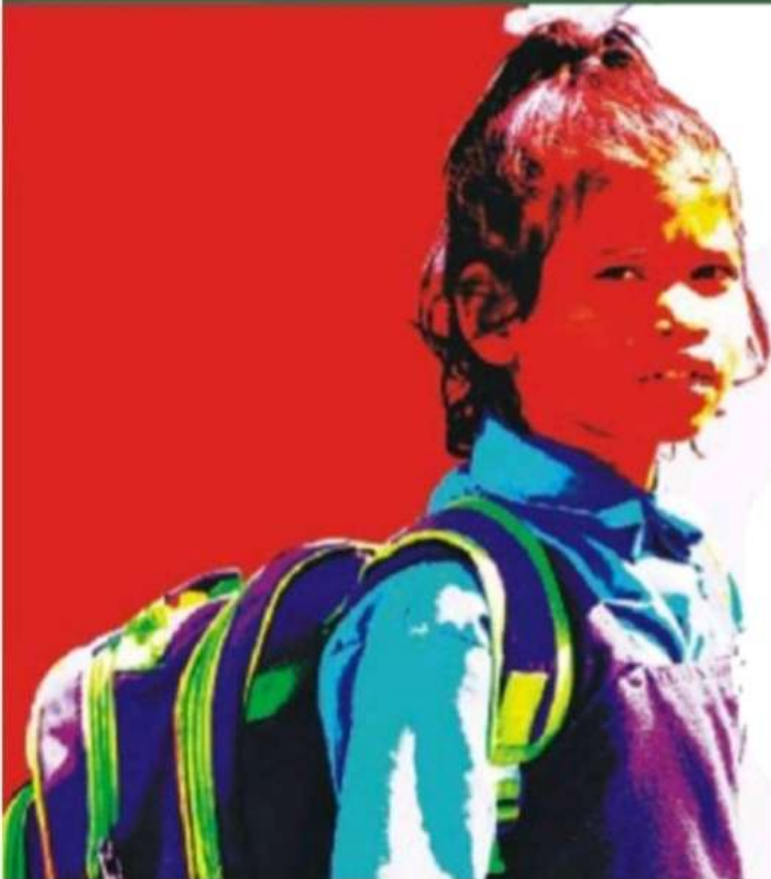
A total of 69 Abstracts were presented in the conference (27 Paper Presentation and 42 Poster Presentations). A total of 14 participants took part in Debate Event and 28 participants took part in Quiz Event.

# Thank You



## Phytocine'22

# Women Education in India



**Dr. Shubhra Jamwal**  
**Dr. R. S. Regin Silvest**

## Contents

1. An Insight into the Skill Development of Women from Ancient to Modern Era Krishnendu K & Dr. Roweena B D'couto	1
2. Socio-Cultural Changes in Modern India Dr. C Thanavathi & S Ramya	10
3. Democratic System in India Dr. Shivanand Patwadi	19
4. Women's Empowerment Srilakshmi Priyadharshini G	29
5. The Women and Higher Educational Institutions in India: A Challenges Ahead Subal Tandi	36
6. Sociocultural Change Ramyasree M	56
7. A Study on Quantitative Research on Women Empowerment Thirst Dr. Latha Lavanya & Sumanah Tamkeen M R	65
8. Analysis of Support and Assistance via "Beti Bachao Beti Padhao Scheme" (Save the Daughter, Educate the Daughter) for Women Empowerment in J&K UT Huma Akhtar Malik & Fizana Ashraf Malik	85
9. Women's Education: Challenges in 21 <sup>ST</sup> Century Simran Parveen	94



TITLE : Women Education in India  
E-ISBN : 978-93-93333-39-1  
Editors : Dr. Shubhra Jamwal & Dr. R. S. Regin Silvest  
Price : 150/- INR  
Published by : Island Publishers  
Tamilnadu, India  
www.islandpublishers.in  
Imprint at : Island Publishers  
Tamil Nadu, India

Copyright © 2022 by Island Publishers, All rights Reserved.

No part of this publication may be reproduced or transmitted in any form or by any means, electronic or mechanical, including photocopying, recording, or any other information storage and retrieved without prior permission in writing from the publishers.

Concerned author is solely responsible for his views, opinions, policies, copyright infringement, legal action, penalty or loss of any kind regarding their content. The publisher will not be responsible for any penalty or loss of any kind if claimed in future. Contributing author have no right to demand any royalty amount for his content.

## Introduction

The Indian government has expressed a strong commitment towards education for all, however, India still has one of the lowest female literacy rates in Asia. In 1991, less than 40 percent of the 330 million women aged 7 and over were literate, which means today there are over 200 million illiterate women in India. This low level of literacy not only has a negative impact on women's lives but also on their families' lives and on their country's economic development. Numerous studies show that illiterate women have high levels of fertility and mortality, poor nutritional status, low earning potential, and little autonomy within the household. A

## 9. Women's Education: Challenges in 21<sup>ST</sup> Century

Simran Parveen

MA(Political Science), SET, 17,B.T. ROAD, TITAGARH, GIRJA  
BAZAR, KOLKATA, 24 PGS(N)

### Abstract

Education is the only mechanism through which one can change his/her life. It is the only skill which cannot be taken back but only enhance. In India, women have been observing as second citizen and weak human being. The status of women in society can be uplift by providing primary and secondary level education. The both government of center and states have been contributing in empowerment of women by launching several schemes. Unfortunately, a vast number of women are still lagging behind and serving their life only in house hold work. It assumes that women are technology challenged and not upgraded who can handle science, technology and academic burden. Therefore, they should provide easy access of education and not professional courses. The other cause of women's inferiority is, most of the women complete their education through government aided school and for that they cannot speak fluent English which is coming their way to achieve success. Apart from these, there are list of challenges that women face in pursuing their education which might be figure out in further discussion.

**Keywords:** Education, History of Education, Committee's of Women, Higher Education, Challenges.

Education is the key to success of empowerment and development of a group of people and a country. Marry Wollenstrocrafft in her book, "A Vindication of the Right of the Women" advocated the women's education in rational perspective. In her view, educated women can educate the whole country.

In our country 48% of the population is women and being representing half of the population their education is at most important

94

otherwise half of the population would be illiterate and a country in overall. The government of India, after its independence, have been launching several schemes regarding this matter such as Rajiv Gandhi for Empowerment of Adolescent Girl- SABLA, Samgra Shiksha, Mid Day Meal, Infrastructure Development in Minority Institutes(IDMI), Kanyashree Prakalpa, etc. However the success of women in education is still a challenge for our country. The figure out reasons are many but two are dominating, one is patriarchal structure of society and other is the lack of effective implementation of these schemes. The result is 65.54% of the women are literate and 34.54% of the women do not have excess of education and forced to live in a veil of ignorance.

The criteria of being literate in India since 1991 census is that the total percentage of the population of an area at a particular time aged seven years or above who can read and write with understanding are considered literate. The criteria of literacy is in favour of primary education and the fundamental rights of the constitution, article 21(A) deals with the free and compulsory education to the children between the age of 6 to 14 years, is also promoting primary level education to increase the literacy rate of the country. The government of both states and center provide basic amenities of education to women in order to have the availability of primary level education to all such as school bags, school books, note books, school dresses with shoes and mid day meal along with these. The outcome of this strength is that the percentage of the primary level education has jumped up from 54.16% to 64.6% in 2011. This is the artillery of bridging the gap of gender inequality and pushing more women in educational spectrum.

In general, the purpose of education is not only to enable a person



# A J O M C

Asian Journal of Organic & Medicinal Chemistry

Volume 7, Number 2

April - June 2022

ISSN: 2456-8937



<http://ajomc.asianpubs.org>



Asian Publication Corporation  
Sahibabad (India)  
<http://asianpubs.org>

Editor-in-Chief

**Dr. Bimal K. Bainik**

Vice President of Research & Education Development  
Community Health Systems of South Texas  
Edinburg, USA

# Asian Journal of Organic & Medicinal Chemistry

**Editor-in-Chief**

**Bimal Krishna Banik**

Professor and Senior Researcher

Department of Mathematics and Natural Sciences

College of Sciences and Human Studies

Deanship of Research Development

Prince Mohammad Bin Fahd University, Kingdom of Saudi Arabia

## **Editorial Advisory Board**

**Prof. (Dr.) Doralyn S. Dalisay**

Head, Department of Pharmacy

College of Pharmacy and Medical Technology University of San Agustin Iloilo City, Philippines

**Prof. (Dr.) Hongchao Zheng**

Center for Integrative Chemical Biology and Drug Discovery,

UNC-Chapel Hill, Chapel Hill, NC 27599

**Prof. (Dr.) Marek Cyprian Chmielewski**

Institute of Organic Chemistry

PASKasprzaka 44/5201 - 224 Warsaw 42,

P.O. Box 58 Poland

**Prof. (Dr.) Joaquín Tamariz**

Department of Organic Chemistry, National School of Biological Sciences,

National Polytechnic Institute. Prol. Carpio and Plan de Ayala, 11340 Mexico City, DF, Mexico

**Dr. Biswa Mohan Sahoo**

Department of Pharmaceutical Chemistry

Vikas College of Pharmacy, Vissannapeta, Krishna Dist.

Andhra Pradesh, India

**Dr. Pranjal Baruah**

Department of Applied Science

Gauhati University, Guwahati, India

**Dr. Jhuma Ganguly**

Department of Chemistry

Indian Institute of Engineering Science and Technology

Shibpur, India

**Dr. Chittaranjan Sinha**

Department of Chemistry

Jadavpur University, Kolkata, India

**Dr. Aman Bhalla**

Assistant Professor

Department of Chemistry & Center of Advanced Studies in Chemistry

Panjab University, Chandigarh

**Dr. Hemant Vilas Chavan**

Department of Chemistry

A.S.P. College, Devrukh, Ratnagiri, India

**Dr. Seema P Mengshetti**

Emory University, E469

Laboratory of Biochemical Pharmacology

Health Sciences Research Building

1760 Haygood Drive, Atlanta GA 30322

**Dr. Shovan Mondal**

Department of Chemistry

Syamsundar College, Shyamsundar, Purba Bardhaman, India

# **Asian Journal of Organic & Medicinal Chemistry**

**Special Issue**

**on**

**Current Trend on Research in Applied Science,  
Management and Technology**

**CONTENTS**

---

***Research Papers***

- An Empirical Study on Factors Influencing Consumer Adoption of Cashless Payment in Bengaluru** 1 – 4  
*Kiran Anandan*
- An Overview of the Adguard Based Security System for Hybrid Model** 5 – 15  
*Shambhu Sharan Srivastava and Abhishek Mishra*
- The Study of Selected Initial Public Offering in India for a Period of 3 Years from 2019 To 2021** 16 – 22  
*Monika Gorkhe and Aanchal Garg*
- Science Ethics are Included in the Science Book of Iraq for the Firstgrade in Middle School** 23 – 29  
*Noor Mohammed Kadhim, R. Meenakshi, Mustafa Mahdi Abdulridha and S. Pushparaj*
- A Study on Job Satisfaction amongst Anganwadi Workers in Mumbai Region** 30 – 35  
*Reshma Rajaram More and Varsha S. Mallah*
- Agri-Business: A Ray of Hope to Indian Economy Amid Covid-19 Crises** 36 – 44  
*Kalpna Rawat, Raj Kiran Prabhakar and Jatoth Sai Kiran*
- A Review of Indian Automobile Industry** 45 – 48  
*Pankaj Gupta and Pooja Vidyarthee*
- A Study on Emotional Intelligence and Academic Performance of Rural and Urban Students** 49 – 53  
*Rishika D*
- Role of Artificial Intelligence (AI) In Tackling Covid-19** 54 – 57  
*Pradhnya M Wankhade and Shraddha Kokate*
- The Healthcare System in India** 58 – 62  
*Pradeep H. Tawade*
- A Study on Real Estate Industry in Mumbai: A Challenge** 63 – 69  
*Akshaya Bagwe and Neelam Arora*

<b>A Study on Skill Required For Commerce Graduates – A Key of Transformation in Commerce &amp; Management for Economic Development and Sustainability</b>	70 – 72
<i>Manisha N. Ajara and Ashok S. Luhar</i>	
<b>Assessment of Surface Gamma Radiation and Water Quality Parameters with Special Focus on Uranium and Fluoride in Ground Water: A Case Study of Baran District, Rajasthan, India</b>	73 – 87
<i>R. Meena, K. Parashar, S. K. Sharma, S. N. Tiwari, S. K. Sahoo and A. Rani</i>	
<b>A Review of Research on the Participation of Private Hospitals in the Functioning of Government-Led Health Insurance Schemes, Across India, with Special Context to Ab-Pmjay Scheme</b>	88 – 90
<i>Pallavi Omkar Sawant and Ashok S. Luhar</i>	
<b>Comparative Thermal Performance Evaluation of Single and Double Twisted Tape Inserted in Evacuated Solar Water Heater</b>	91 – 93
<i>Hitendra Damarlal Chaudhary and Sadanand A. Namjoshi</i>	
<b>Comparative Thermal Degradation Evaluation of Newspaper and Glossy Paper Constituents</b>	94 – 98
<i>Samit Kumar Singh and Sadanand A. Namjoshi</i>	
<b>Pathophysiological Changes in Placenta in Anaemic and Hypertensive Pregnant Women</b>	99 – 104
<i>Shahina Khan, Yogesh Tripathi, Yogesh Kumar Yadav, Dolly Rastogi and Rinku Garg</i>	
<b>An Exhaustive Survey of Deep Learning Models for Analysis and Classification of Facial Expressions of Kathak Dancers</b>	105 – 113
<i>Apeksha Khopkar and Ashish Adholiya</i>	
<b>Analyzing Mapping of ISO 27001: 2013 Controls for Alignment with Enterprise Risks Management</b>	114 – 119
<i>Ashish Ukidve, S. S Mantha and D. N. Reddy</i>	
<b>Development of Hybrid Model for Predicting Dengue and Viral Proteins in Its Genome</b>	120 – 123
<i>Brijesh D. Mehta</i>	
<b>Artificial Intelligence and Machine Learning Prospects for Banking Risk Management</b>	124 – 131
<i>Deepa Honrao and Yashwant Patil</i>	
<b>Analysis Phase of Process Maturity Model for Rpa Implementation</b>	132 – 142
<i>Rasika Mallya</i>	
<b>Review on the Use of Expert System in Cognitive Development of Children</b>	143 – 147
<i>Gauri Deshpande Shabnam Sharma and Anjali Kulkarni</i>	
<b>Impact of Artificial Intelligence across Different Workforce Sectors</b>	148 – 156
<i>Maria Achary and Ramakrishnan Achary</i>	

<b>An Empirical Study of Classifying Learners on Imbalanced Data Set</b>	157 – 160
<i>Prabha Siddhesh Kadam and Girish Tere</i>	
<b>Expert System for Sanskrit Grammar</b>	161 – 165
<i>Pratibha Mangesh Jadhav and Gauri Chetan Deshpande</i>	
<b>Computational Social Choice A Mutually Enriching Alliance between Computer Science &amp; Social Choice Theory</b>	166 – 172
<i>Pratik A. Desai</i>	
<b>Generalized Implementation of Virtual Reality on Non-Immersive Display System with Head Tracking</b>	173 – 176
<i>Shubhangi Pasalkar</i>	
<b>NLP: Institute Review Feedback Using Sentiment Analysis</b>	177 – 182
<i>Sulakshana Vispute, Abhiraj Ghadge and Rahul Mithavkar</i>	
<b>Threats and Defense for Social Networking in Current Era – An Eye Opener</b>	183 - 187
<i>Sulakshana Vispute, Mokshada Mahesh Potdar and Shubhangi Potdar</i>	
<b>A Study on the Sustainable Development Knowledge, Attitudes and Behaviours of Prospective Teachers in Manipur</b>	188 – 192
<i>Chongtham Khogendra Singh, Sarungbam Sen Singh and H. Ibomcha Sharma</i>	
<b>Analysis and Weight Optimization of Four-Wheeler Steering Yoke</b>	193 – 200
<i>Shrikant Kanade and Prashant Anerao</i>	
<b>Quality Assessment of Commercially Available Indian Honey</b>	201 – 205
<i>Joe. Saajit Jeyan, Ghadevaru Sarathchandra and Periyar Selvam</i>	
<b>Cyber-Activism and Youth in India a Case Study of CAA Protest</b>	206 – 216
<i>Jenith Sekar and Kuldeep M. Siwach</i>	
<b>A Study on Out-Of-The-Class Training As Perceived By Students of Arts and Science Colleges in Krishnagiri District</b>	217 – 220
<i>I. Aruljothi and R. Prabhu</i>	
<b>Enhancing Ready-To-Eat Lentils by Retort Packaging Method</b>	221 – 226
<i>Preethi Jasmine J and Ghadevaru Sarathchandra</i>	
<b>A Study on Effetiveness of Online Teaching Methods for Autonomus College Students</b>	227 – 231
<i>K. Chendur Priyadharshini, C. Jestina Jeyakumari and N. Muthuselvi</i>	
<b>Evaluation of Quality Criteria on Mango Pickles</b>	232 – 236
<i>C. Thabithal Helina and Ghadevaru Sarathchandra</i>	

<b>The Status of the Government Health Programmes in the Government Schools in Imphal East District of Manipur: A Case from Health Education Teachers</b>	237 – 239
<i>Bob Dev Waikhom and Yengkhom Santikumar Singh</i>	
<b>Aflatoxins in Milk and Milk Products: Detection, Control and Decontamination - A Review</b>	240 – 251
<i>Shantanu M and Sarathchandra Ghadevaru</i>	
<b>Comparison of Job Satisfaction among Male and Female Government College Teachers in Imphalwest District, Manipur</b>	252 – 259
<i>Tayenjam Kanta Singh and Ch. Beda Devi</i>	
<b>Role of Hydrogen Ion Concentration (PH) Of Water for the Growth of Cyanobacteria (Blue Green Algae) In Some Sites of Darrang, District Assam, In Pre</b>	260 – 262
<i>Matiur Rahman and Milu Rani Das</i>	
<b>Turmeric Powder Samples for Its Quality (Cucurma Longa)</b>	263 – 270
<i>Reshma BhanuKumar and Ghadevaru Sarathchandra</i>	
<b>An Analysis of the Effective Viscosity of Nanofluids</b>	271 – 281
<i>Shefali Gupta, Ritu Pasrija and Saurabh Narang</i>	
<b>A Comparative Analysis of Antioxidant Activities in Caralluma Indica Stem, Phoenix Pusilla Leaves and Sansevieria Roxburghiana Leaves Extracts</b>	282 – 290
<i>A. Satish, S. Durgadevi and A. Leema Rose</i>	
<b>Caralluma Indica Stem, Phoenix Pusilla Leaves and Sansevieria Roxburghiana Leaves Extracts as Green Corrosion Inhibitors for Mild Steel in Acid Medium</b>	291 – 303
<i>A. Satish, S. Durgadevi and A. Leema Rose</i>	
<b>Corporate Attributes and Corporate Website Disclosure</b>	304 – 309
<i>Savita Sindhu</i>	
<b>A Case Series on Clinical Efficacy of Siddha Management in Covid-19</b>	310 – 313
<i>Chithra M, Arivol R and Sundari K</i>	
<b>Impact of Talent Acquisition Practices on Service Sector in Mumbai</b>	314 – 318
<i>Ritika H. Pathak</i>	
<b>Implementation of Data Transmission from PC To PC Using Lifi Technology</b>	319 – 325
<i>D. Praveena Bai, Dasi Swathi and K Phani Rama Krishna</i>	
<b>Cerium Doped Tin Oxide Nanoparticles (Ce-Sno<sub>2</sub> Nps) Synthesized From Ipomoea Carnea Flower Extract and Assessment of Its Antimicrobial Activity</b>	326 – 333
<i>Manivannan Prasanth and Gurusamy Muruganandam</i>	



<b>A Review on the Recent Developments on Solid Desiccant-Based Technology in HVAC Applications</b>	334 – 342
<i>Alice D'souza, Pragnesh Brahmhatt and Ratnesh Shukla</i>	
<b>Invitro Determination of Anti-Aging Activity of (Ananas Comosus L) Using Mccooy Cell Line</b>	343 – 355
<i>Abirami J, Sathish Kumar N. M, Hariharan G and Mahalaxmi S</i>	
<b>A Study of the Awareness and Impact of Organic Food within Generations (X &amp; Y)</b>	356 – 362
<i>Girish Deore and Seema Zagade</i>	
<b>Pandemics - An Environmental Diet</b>	363 – 366
<i>Ganatra Kashyap</i>	
<b>Status of Women in Higher Education with Special Reference to Assam</b>	367 – 371
<i>Pallabi Goswami, Bhabana Chutiya and Nirmali Puzari</i>	
<b>Formulation and Charecterization of Polymeric Nanoparticle of Antihypertensive Drug Bosentan</b>	372 – 379
<i>Subhasri Mohapatra, Deepak Dash, Manish R. Bhise, Ashish Kandalkar, Sanjay Vasu, Sunny Pahuja and Nitin S. Bhajipale</i>	
<b>Synthesis of derivatives of Cholorosubstituted Flavone and Effects of Chlorosubstituted derivatives of Flavone on some Kharif Crop Plants</b>	380 - 384
<i>S.G. Kalane, B. K. Dhotre and S. P. Rathod</i>	
<b>A Study on Employee Inclusion of Squarefoodmeal Pvt Ltd among Speech and Hearing Impairment (SHI) Individuals in Mumbai</b>	385 – 386
<i>Rhutula Jadhav</i>	
<b>Some Medicinal Plants Mix Grow with Mulberry Plant</b>	387 – 389
<i>Shashi Kanta</i>	
<b>Effect of Irrigation Systems on Growth of Various Parts of Mulberry Plant by Spacing Method</b>	390 – 392
<i>Shashi Kanta</i>	
<b>Impact on Development Sericulture Activities to Enhance Silk in Punjab</b>	393 - 396
<i>Shashi Kanta</i>	
<b>A Study of Employee Training Practices of Reputed Hotels in Capital Complex of Arunachal Pradesh</b>	397 - 401
<i>Karjum Riba Rosna Magra and R.C. Parida</i>	

<b>Identification, Screening of Heavy metal Resistant Bacteria and Bioremediation of Heavy Metals in Waste Water by using Different Bacterial Strains</b>	401 – 408
<i>Venkatesh Vangeapurapu and Alapati Krishna Satya</i>	
<b>Impact of Social Media on Interpersonal Communication in Uttar Pradesh</b>	409 – 413
<i>Chhaya Bjpai and Sita Devi</i>	
<b>Internet Dependency and Use of Ict among Students: A Study of Higher Education Institutions in Uttar Pradesh</b>	414 – 417
<i>Bhavna Dubey and Sita Devi</i>	
<b>Impact of Micro Finance on Enterprise Development in Uttar Pradesh</b>	418 – 422
<i>Sagar Shukla and Trupti Singh</i>	
<b>Kinetics and Mechanism of the Oxidation of Menthol by Benzimidazolium Dichromate</b>	423 – 430
<i>Amol P. Kharche, Rajendra T. Jagtap, Sandip K. Jagadale, Hiral C. Surani and Hariram R. Yadav</i>	
<b>First Report of Microcystin and Cylindrospermopsin in the Dal Lake, Kashmir: <i>In-Silico</i> Bioactivity Analysis of Cyanotoxins</b>	431 – 441
<i>Fahim Bashir, Rongwei Shi, Khalid M. Fazili and Bashir Ahmad Ganai</i>	
<b>A Study of Test Anxiety in Relation to Academic Achievement of Secondary School Students</b>	442 – 445
<i>Sourav Talapatra</i>	
<b>Two Fast and Effective Instrumental Analytical Methods for Quantitative Estimation of Cilnidipine in Marketed Formulation</b>	446 – 455
<i>Pranali Mishra and Parul Mehta</i>	
<b>Heavy Metal Distribution and Contamination in Surface Water of Vellar Estuary, Southeast Coast of India</b>	456 – 462
<i>N. Jakeer, S. Arunadevi and R. Sivasamandy</i>	
<b>An Study on Investors Awareness and Their Perception towards Mutual Fund As an Emerging Option for Investment in A Developing Economy-With Special Reference to Tumkur City an Indian Context</b>	463 – 473
<i>Roshan K and M. R Jhansi Rani</i>	
<b>Synthesis and Biological Evaluation of Novel N-Substituted Isatin Derivatives as Potent Antimicrobial Agents</b>	474 – 479
<i>K. M. Borse, Narendra Sonawane and Pundalik Mali</i>	
<b>Bio-Polymer: Carboxy-Methyl Tamarind Kernel Gum</b>	480 - 482
<i>Ritu Malik</i>	

<b>Formulation and Evaluation of Guaifenesin Hard Candy Lozenges</b>	483 – 489
<i>Shailaja Pashikanti, Teja Sri Soumya Kari and G. Snehalatha</i>	
<b>A Review on Leadership Vs Management</b>	490 - 493
<i>N. Shesha Malini</i>	
<b>Heavy Metals Accumulations (Mn, Zn and Cd) of Lantana camara for the Phytoremediation of Contaminated Soils</b>	494 - 502
<i>K. Sanghamitra</i>	
<b>A Study on Recent Trends in Life Insurance Business</b>	503 – 508
<i>Bhupesh V. Rane, Raj M. Mhatre and Khoj Agarwal</i>	
<b>Dr. Babasaheb Ambedkar’s Contribution to the Emergence of the Reserve Bank of India</b>	509 – 510
<i>Bhupesh Rane, Shalu Chanana and Kaustubh Kamble</i>	
<b>Concealed Compensations: A Missing Facet of HR in the Indian Banking Sector</b>	511 – 516
<i>Bhupesh V Rane, Abhinandan Kumar and Abhishek Budhkar</i>	
<b>A Review of Supply Chain Challenges in Indian Steel Industry</b>	517 – 524
<i>Suneet Mathur and Prasanta Kumar Mohanty</i>	
<b>To Identify Emerging Trends and Competitive Strategies Adopted by the Hospitality and Tourism Industry during Covid-19 Pandemic</b>	525 – 531
<i>Dhanraj Kalgi, Pralhad Botre and Arvind Sonkamble</i>	
<b>Women Entrepreneurs in India-What Chains Their Success?</b>	532 – 538
<i>Satish Kumar and Kanika Thakur</i>	
<b>Contribution of Women from North-East India in the Field of Science and Technology</b>	539 – 552
<i>Biplab Banik</i>	
<b>Di-Biotin-RGD: A Novel ARG-GLY-ASP Derivative with Diagnostic and Therapeutic Potentials against Breast Cancer</b>	553 – 567
<i>Bonaventure Mujiyambere, Priyadharshini Thangavelu, Kaavya Gunasekaran, Viswanathan Sundaram, Anusuya Nagaraj, Akshayadharshini Kariselvan, Sreelakshmy Sureshkumar, Sangita Sharma Mehta, Suja Samiappan and Suja Samiappan</i>	
<b>A Comprehensive Study on Biomass Derived Carbon Dots</b>	568 - 605
<i>Mohd Abdullah Sheikh, Khan Abida and R S Chandok</i>	
<b>Pharmacognostic and Phytochemical Evaluation of Andrographis Serphyllifolia (Rottl.Ex Vahl.) WT</b>	606 – 622
<i>Venu. Velidi, Swaroopa Rani. A and Kothapalli Bonnoth Chandrasekhar</i>	

<b>Study of Antioxidant Activity, Phenolic and Flavonoid Contents from Citrus Sinensis and Citrus Reticulata Peel Extracts</b>	623 – 625
<i>Chandanshiv Suchita Laxmanrao and Wadikar Madhukar Subhash</i>	
<b>Phytoplankton and Zooplankton Diversity of Stagnant Water of Masoli Dam from Gangakhed Tahasil District Parbhani</b>	626 – 627
<i>Anirudha Budrukar and Sabiha V Syed</i>	
<b>Design and in-Silico Studies of 2-Hydroxy-5-((5-(Substituted Styryl) Isoxazol-3-Yl) Diazenyl) Benzoic Acids</b>	628 – 634
<i>Madhavi Kuchana and Divya Satyakala Kornik</i>	
<b>A Facile &amp; Efficient Synthesis, Characterization of Alkyl and Aryl Substituted Bis 1, 3, 4-Oxadiazol</b>	635 – 639
<i>M. N. Gulhane</i>	
<b>Secure Digital India: The Role of Artificial Intelligence in Cybersecurity</b>	640 - 649
<i>Prashant Chauhan and Gagandeep Kaur</i>	
<b>PMJDY: Understanding its Benefits and Challenges in Implementing Financial Inclusion in India</b>	650 – 655
<i>Navsin Mistry and Arvind S Luhar</i>	
<b>Portrayal of Human Relations and Emotions by Ruskin Bond</b>	656 – 658
<i>Sanchna Chopra and Vinaya Kumari</i>	
<b>Resilience and Depression among Diabetic and Non-Diabetic Individuals</b>	659 – 662
<i>Maria Varisa Sequeira and Shivakumara K</i>	
<b>The Essence of Blended Learning: Challenge and Future</b>	663 – 668
<i>Nidhi, Kshama Sharma, Prachi Goyal and Meghna Aggarwal</i>	
<b>Stain and Pain of Liam in Luna by Julie Ann Peters</b>	669 – 671
<i>Mariena Kamala Brinda Noel S and R. Jayakanth</i>	
<b>Green Chemistry in Nanoparticles Catalysis</b>	672 – 675
<i>Prasad Indradeo and Agrawal Seema</i>	
<b>Impact of Health Consciousness and Food Safety Concern on Consumer Buying Behaviour – A Review on Organic Food Products</b>	676 – 686
<i>Tarun Gupta and A. K. Sarkar</i>	
<b>A Study of Biomedical Raman Spectroscopy in Fiber Optical Probe</b>	687 – 690
<i>Monirul Islam and Agrawal Seema</i>	

**New Ligands for Organometallic Catalysts Characteristics and Applications** 691 – 695

*Sikdar Moumita and Agrawal Seema*

**Novel Data Dimensionality Reduction Approach Using Static Threshold, Minimum Projection Error and Minimum Redundancy** 696 - 705

*Satish S. Banait and S. S. Sane*

---

---

## **An Empirical Study on Factors Influencing Consumer Adoption of Cashless Payment in Bengaluru**

**Kiran Anandan**

Bangalore University, Bengaluru, Karnataka, India

### **ABSTRACT**

In this study, a well-established unified theory of technology adoption and use is used to evaluate factors impacting the adoption of cashless payment in Bangalore. To test the hypotheses, a total of 150 completed and useable surveys were gathered from customers. Explanatory variables Performance Expectancy, Facilitating Condition, Social Influence, Innovation, and Perceived Technology Security were found to have a substantial impact on the outcome variable Variable Adoption of Cashless Payments by multiple regression analysis. The Adoption of cashless payments was found to be influenced by factors such as Performance Expectancy, Facilitating Conditions and Perceived Technology Security. Policymakers might use these insights to address consumer concerns and make the move to a cashless world a success. SPSS 20 statistical analysis tool is used for analysis and data management.

Keywords: Cashless Payment, Technology adoption, Multiple Regression, SPSS

### **INTRODUCTION**

Globally, a cashless society and technological innovation are gaining popularity (Fabris, 2019) Consumers make financial transactions without physical cash (Bilińska-Reformat & Kieźel, 2016) mostly utilizing cards or electronic ways.

Adopting cashless payments has numerous advantages for consumers. Paying using cash is cumbersome and time-consuming (Teo, Tan, Ooi, Hew, & Yew, 2015) . Unlike traditional cash transactions, cashless payments reduce the risk of robbery and other cash-related crimes, according to (Armeý, Lipow, & Webb, 2014). The majority of studies revealed that consumers who desire to go cashless must first have access to financial services as well as macroeconomic and cultural factors. These are a few of the determinants of whether or not people would use cashless payment systems, and we examine them in our research.

Consumer cashless payment difficulties, according to (Swiecka, 2019) are an important and diverse topic in financial research. The practicalities of cashless payments must be weighed against theoretical achievements. To better understand the phenomenon under study, we need to acquire new descriptive and exploratory knowledge. Commercial and policy proposals for cashless transactions may be aided by this understanding as well. One of the best indicators of economic progress today is the use of electronic funds transfers, or "cashless payments." Cashless payment adoption will be examined as part of this research project. We asked this question since the study's purpose was to find out what factors influence customers' adoption of cashless payment systems. The primary goal of this study is to have a better understanding of how customers feel about cashless transactions. Vendors of technology frequently concentrate on the system as a whole, oblivious to the needs of end-users.

Section two reviews the literature on cashless payments, covering non-cash payment, mobile payment, adoption, and technology information. Section three focuses on the goals and hypotheses that go along with them. The study's methodology is described in Section four, while the results and analysis are discussed in Section five. Section six wraps up and sums up the Conclusion.

### **2 . LITERATURE REVIEW**

(Mandaa & Margana, 2016) The Demonetization of high denomination banknotes in India in 2016 may lead to a cashless society. With varying degrees of success, several countries worldwide are trying out cashless transactions. India's global practices and user perception are investigated. The survey data is analyzed to learn more about customer payment difficulties. What makes customers go cashless? What hinders cashless transactions? To promote India's cashless economy, what can the general public, banks, and governments do?

(Parmar, 2018) Financial transactions in a cashless society are carried out utilizing digital information (typically the computer representation of money). Transactions can now be completed without the use of cash thanks to the advent of digital currencies such as cookies and Bescker and other means of trade. Legal tender (money) is present in this article, but its digital counterpart is recorded and replaced, meaning that we are moving toward a "cashless society." Because it's intended for a specific audience, the phrase can only be shared digitally. The

cash-based economy in India is beneficial for several reasons. Using paper to lubricate economic activity has drawbacks. According to a Tufts University study, cash operations cost the RBI and commercial banks over Rs21, 000 crore yearly. In a fiscally constrained society, a shift away from cash will also make it more difficult for tax evaders to hide their income. This paper examines the benefits and drawbacks of a cashless society.

(Lele, 2019) In November 2016, India demonetized 500 and 1000 rupee notes to foster a cashless economy and fight corruption. The sudden demise of currency and the time it took to restore it forced consumers and merchants to seek alternate payment alternatives. Unorganized retailers were hit the worst. This produced cashless choices like card payment POS machines and Smartphone apps. Mobile phones and cheap data bundles have increased the appeal of cashless transactions among consumers and small enterprises. Several surveys demonstrate an increase in cashless payment acceptance among Indian retailers during the last three years. The current study aims to assess cash payments in Pune. Small businesses accept cashless payments in 85%. Paying with a card is expected to produce around 45% of retail transactions. Mobile apps now account for 48% of cashless payments in Pune.

(Rahman, Ismail, & Bahri, 2020) This study examines the determinants of Malaysia's adoption of cashless transactions using the UTAUT2 theory of unified technology adoption and use. Valid questionnaires from Malaysian clients were obtained for testing the hypothesis. The data was analysed and AMOS analysis was applied using Structural Equation Modeling (SEM). Performance expectations and conducive conditions are found to have the greatest impact on the uptake of cashless payments, according to the findings. There is a substantial correlation between the acceptance of cashless payment and the perception of technology security. Cashless payment adoption is also linked to hedonic motivation, social influence, and innovation, according to the findings. Using these insights, governments may be able to address current consumer concerns for a successful cashless society transition.

(Cwynar, Świecka, Filipek, & Porzak, 2021) People need to know how to safely and successfully use cashless marketplaces in the wake of the COVID-19 epidemic, which has accelerated the international digital revolution. Using information collected from a representative sample of Polish adults, we devised and tested an innovative knowledge measure for cashless payment systems (CPK scale). Within the CPK framework, our Item Response Theory analyses have uncovered other subdomains worth exploring. The CPK's distinct dimensions are combined into a single scale in this scale. Based on factors such as education level and household size, the CPK score favorably influences safe cashless behavior and is associated with the CPK score. It is possible that the findings could help financial institutions and governments reduce risks associated with knowledge gaps and improve financial literacy.

(Srishti & Mahender, 2021) As the Internet has grown, so too has the possibility for online shopping grown. It's a problem for potential customers because of the rise of Internet shopping. This research tries to find the challenges and hurdles that prevent online customers from making payments through cashless means. Using a standardized questionnaire, 600 participants were interviewed. The acceptability of cashless payment by online customers is unaffected by demographic features such as gender, as revealed by t-Test and ANOVA. A complex system, perceived risk and lack of trust, the habit of cash payments, self-inefficacy, and security difficulties were identified as the five elements that were analyzed.

### **3. OBJECTIVE OF STUDY**

- 1) To find the relationship between Performance Expectancy, Facilitating Condition, Social Influence, Innovativeness, and Perceived Technology Security
- 2) To find whether there is Impact of explanatory variable such as Performance Expectancy, Facilitating Condition, Social Influence, Innovativeness, and Perceived Technology Security on outcome variable Adoption of Cashless Payments

### **HYPOTHESIS**

H1: there is Impact of explanatory variables such as Performance Expectancy, Facilitating Condition, Social Influence, Innovativeness, and Perceived Technology Security on outcome variable Adoption of Cashless Payments

### **4. METHODOLOGY**

The proposed hypotheses are tested using a self-administered questionnaire. In order to better understand why people utilise cashless payment methods and what drives their adoption, a variety of cashless payment systems are being investigated. Respondents' opinions on cashless payments were measured on a Likert scale of 1 to 5, with 1 being "strongly disagree" and 5 being "strongly agree." The replies varied from "strongly disagree" (1) to

"strongly agree" (2). (5). The poll includes internet banking, non-cash transactions, and other online transactions for the purchase of products and services. Responses from 100 people were gathered by using Convenient Sampling. The investigation was carried out in the southern part of Bangalore. Use multiple regression analysis to examine the influence of independent variables such as performance expectations, facilitation conditions and social influence on the adoption of cashless payments. In addition to data management and statistical analysis, SPSS version 20 is employed.

### 5. DATA ANALYSIS AND INTERPRETATION

To test the hypothesis that there is an Impact of explanatory variables such as Performance Expectancy, Facilitating Condition, Social Influence, Innovativeness, and Perceived Technology Security on outcome variable Adoption of Cashless Payments Multiple Regression is applied. The descriptive statistics of the parameters of the hypothesis is depicted in the table below

**Table 1:** Descriptive statistics

Parameters	Mean	Std. Deviation	N
Adoption of cashless payments	4.09	.750	150
Performance expectancy	3.99	.737	150
Facilitating condition	4.23	.639	150
Social Influence	4.19	.673	150
Innovativeness	4.11	.700	150
Perceived Technology Security	4.11	.72 8	150

From the table, it is evident that there is no presence of multicollinearity as all the independent variables are not highly correlated and the VIF values of all predictor variables are less than 10.

**Table 2:** Table of Multicollinearity

Variables	Collinearity Statistics		Findings
	Tolerance	VIF	
Performance expectancy	.721	1.387	MultiCollinearity
Facilitating condition	.691	1.447	MultiCollinearity
Social Influence	.537	1.862	MultiCollinearity
Innovativeness	.673	1.486	MultiCollinearity
Perceived Technology Security	.763	1.311	MultiCollinearity

From the model summary table, it is evident that  $R=0.607$  indicates a positive correlation between the Performance Expectancy, Facilitating Condition, Social Influence, Innovativeness, and Perceived Technology Security. The  $R^2$  value indicates the contribution of independent variables on the dependent variable

**Table 3:** Model summary

Model	R	R Square	Adjusted R Square	Std. Error of the Estimate	Durbin-Watson
1	.607 <sup>a</sup>	.369	.347	.606	1.786

The Analysis of Variance table indicates that the regression model statistically predicts the outcome variable which is the Adoption of cashless payments as the p-value is less than 0.05. Therefore we can conclude that the relationship between Performance Expectancy, Facilitating Condition, Social Influence, Innovativeness, and Perceived Technology Security is significant.

**Table 4:** ANOVA Table

	Sum of Squares	df	Mean Square	F	Sig.
Regression	30.952	5	6.190	16.844	.000 <sup>b</sup>
Residual	52.921	144	.368		
Total	83.873	149			

The Coefficient Table predicts the Adoption of cashless payments from the independent variables Performance Expectancy, Facilitating Condition, Social Influence, Innovativeness, and Perceived Technology Security. Out of five independent variables, three variables, Performance Expectancy, Facilitating condition, and Perceived Technology Security are statistically significant as P-value is less than 0.05. Therefore we can conclude that there is the impact of Performance Expectancy, Facilitating condition, and Facilitating Condition on Adoption of cashless payments significantly.



Table 5: Coefficients

	Unstandardized Coefficients		Standardized Coefficients	t	Sig.
	B	Std. Error	Beta		
(Constant)	.298	.420		.709	.479
Performance expectancy	.174	.079	.171	2.198	.030
Facilitating condition	.223	.094	.190	2.384	.018
Social Influence	.171	.101	.153	1.697	.092
Innovativeness	.155	.086	.144	1.789	.076
Perceived Technology Security	.194	.078	.188	2.480	.014

## 6. CONCLUSION

Key factors that influence adoption of cashless payments are the focus of this study. The analysis found that all of the explanatory variables are linked together. It was determined that Performance Expectancy, Facilitating conditions, and Perceived Technology Security had a substantial impact on the Adoption of cashless payments by applying multiple regression analysis.

## REFERENCES

1. Army, Lipow, & Webb. (2014). The impact of electronic financial payments on Crime. *Information Economics and Policy*, 46–57.
2. Bilińska-Reformat, & Kieźel. (2016). Retail banks and retail chains cooperate for the promotion of cashless payments in Poland. . *Proceedings of 15th International Marketing Trends Conference, Venice, Poland*.
3. Cwynar, A., Świecka, B., Filipek, K., & Porzak, R. (2021). Consumers' knowledge of cashless payments: Development, validation, and usability of a measurement scale. *Journal of Consumer Affairs*, 1-6.
4. Fabris. (2019). Cashless society—the future of money or a utopia? *Journal of Central Banking: Theory and Practice*, 53-66.
5. Lele, U. (2019). Adoption of Cashless Payments by Small Retailers in Pune City: An Empirical Study. *International Journal of Research in Engineering IT and Social Sciences*, 20-26.
6. Mandaa, V. K., & Margana, S. (2016). Transformation towards Cashless Economy – An Indian Perspective. *SSRN-Elsevier*, 1-8.
7. Parmar, R. (2018). A Study Of Cashless System And Cashless Society: Its Advantages And Disadvantages. *Indian Journal Of Applied Research*, 1-2.
8. Rahman, M., Ismail, I., & Bahri, S. (2020). Analyzing consumer adoption of cashless payment in Malaysia. *Elsevier*, 1-11.
9. Srishti, & Mahender. (2021). Problems and Challenges in Adoption of Cashless Payment Mode by Online Consumers. *The IUP Journal of Management Research*, 20-36.
10. Swiecka. (2019). A comparative survey over time between cash and cashless payments in Poland. *Contemporary issues in behavioral finance*. Emerald Publishing Limited. , 139-152.
11. Teo, Tan, Ooi, Hew, & Yew. (2015). The effects of convenience and speed in m-payment. *Industrial Management and Data Systems*, 311–331.

## An Overview of the Aduard Based Security System for Hybrid Model

Shambhu Sharan Srivastava and Abhishek Mishra

Department of Computer Science and Engineering, IFTM University, Moradabad, India

### ABSTRACT

Retrieval from several current approaches was determined in this experiment which resulted to a secure system. The issue of developing operating systems which fulfil the criteria is a concern. Understanding what to create is only the first move; the how to create must come next. Both are troublesome, even though they are interdependent. The concept of the hybrid system network security system is suggested. The following is a summary of the research goal:

*'Strengthen system as well as system security methodologies (what), by modifying, expanding, and integrating diverse techniques (how), and used by technology and computer networks (to whom), and developing resilient computer networks (with what objective) which are dynamic and trustworthy (to which quality aspects).'*

### METHODOLOGY

The research methodology for this study is to create a hybrid model which can also be said as an integrated model that will be able to provide two levels of security in the network. The entire methodology for this research is based on the DNSSEC applications and survey of literature in order to obtain possible security issues faced. The model that is proposed and implemented is also to be verified and validated.

The key aspects that will be used in structuring such methodology are presented in this chapter before delving into the models as well as its design aspects.

**DNS Features of AdGuard** – AdGuard DNS is a failsafe solution to block tracking and advertisements on the Internet without having to download any software. It's simple to use, protects your privacy, is completely free, and can be easily installed on any device. It blocks adverts, trackers, harmful websites, and pornographic content, among other things (optionally).

Set up the Domain Name System (DNS) addresses instead of the ones provided by your service provider to begin utilising AdGuard DNS. AdGuard DNS is available for personal usage at no cost.

**Working Mechanism** - When AdGuard DNS is enabled, our server responds with an empty answer every time a browser or app sends an ad request. AdGuard maintains a database of domain names that provide advertisements, trackers, and fraud which is updated on a regular basis. AdGuard DNS can be used in one of two settings. Ads, counters, harmful and phishing websites are all blocked in the Default Mode. In addition to filtering adult content and enabling safe search for your browser, the Family Mode performs the same.

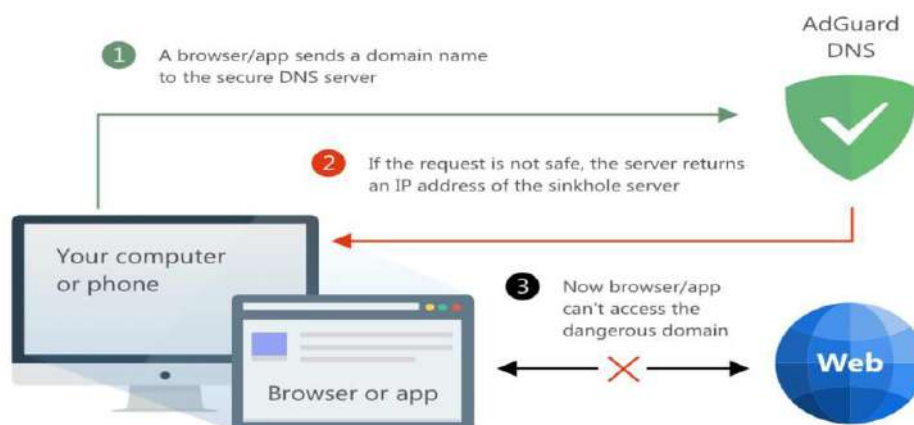


Figure 1: Aduard Working Mechanism

**Designed Hybrid Model** - The Adguard Home is going to be used in designing the proposed hybrid model. AdGuard Home is a network-wide, open source program that allows users to block advertising and trackers while also having complete control over all traffic on their home network. AdGuard Home, with standard ad blocks which only work on a single system or perhaps a single browser, will encompass all devices on your home Wi-Fi network once you've installed it, and you won't have to download the client-side software for each. With the

exception of trackers ads as well as blocking, AdGuard Home can (also was designed to) do a range of other things, like encrypted traffic. AdGuard Home features a straightforward web interface that allows users to regulate traffic from everywhere, especially their smartphones.

This strategy works by transforming it into a DNS server that redirects ads as well as tracking urls to the "black hole," prohibiting customer machines from responding to them. It's centered on the very same software which drives the well-known accessible AdGuard DNS, although there is a lot of code in common.

The Dashboard of the model is shown in the figure 2(a), (b), (c) below:

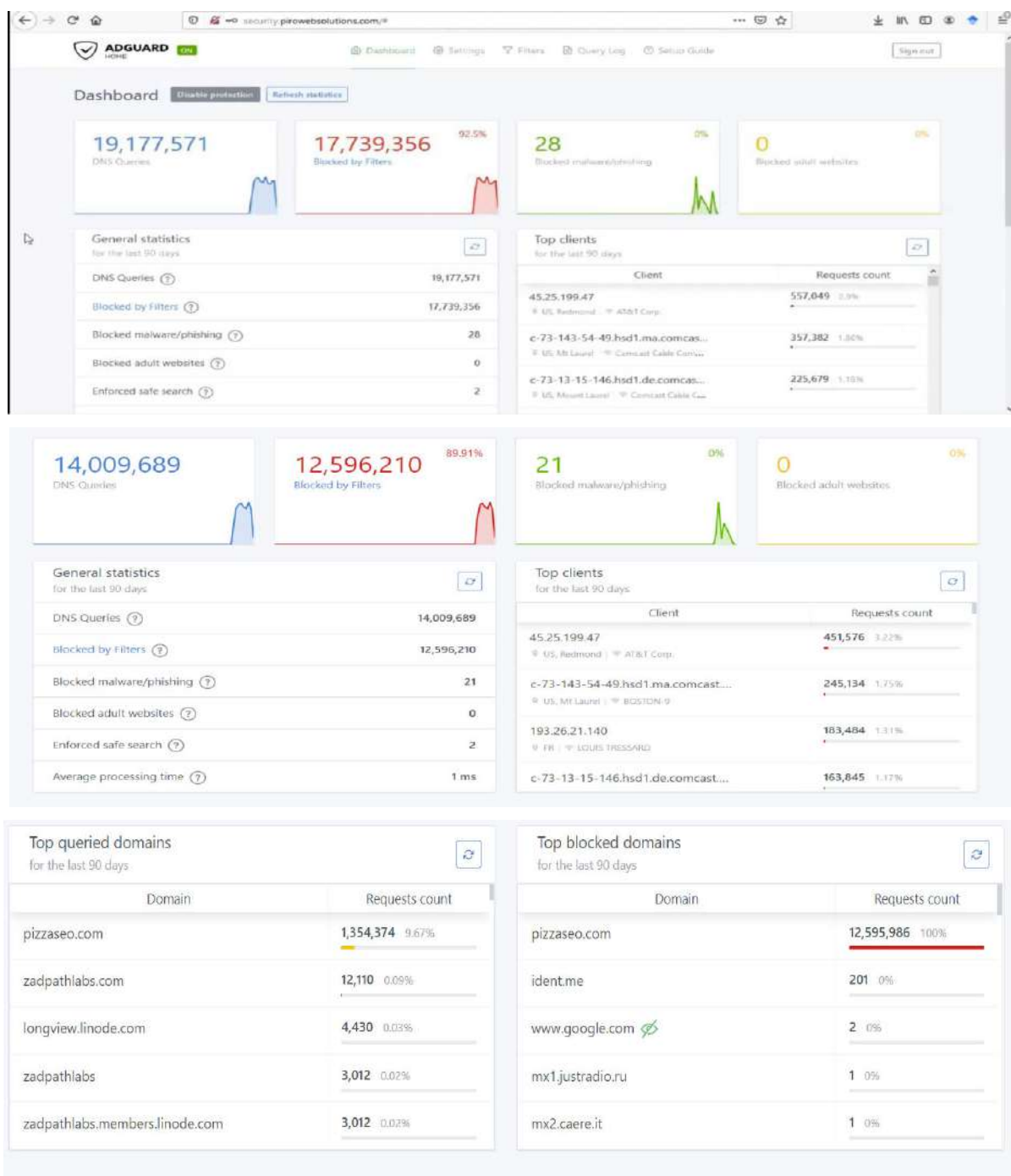


Figure 2 (a, b, c): Dashboard of the Hybrid Model

The model primary characteristics are as follows:

1. As seen from figure 2 (a), the main options in the hybrid model are the Dashboard, Settings, Filters, Query log, Setup guide. As the name implies, the Dashboard gives the main home screen panel, and the settings give the different setting modes that are possible. Filters give the different filtering options in terms of DNS

block lists, DNS allow lists and so on. The query log option present gives the list of all the queries that were encountered by the model.

2. The top of the main panel gives the number of DNS queries that were encountered by the system. The number of queries blocked by the filters along with the percentage of queries blocked is given. In addition, the blocked malware or phishing and blocked adult activities are also displayed on the home screen.
3. In the middle of the panel, the general statistics and top clients in the last 90 days are listed which can be refreshed whenever required. In addition, the request count from each of the clients is listed.
4. In the bottom half of the home screen, the top queried domains and the top blocked domains are displayed. In this, the different websites' names and the requests count will be displayed.

The next sections present insights on each of the options accessible on the dashboard once you've seen the overall layout of the model created as well as the dashboard information.

**Settings Options** - The settings options are located next to the dashboard in the main panel. The different setup options which have been added to the panel are shown in Figure 3.

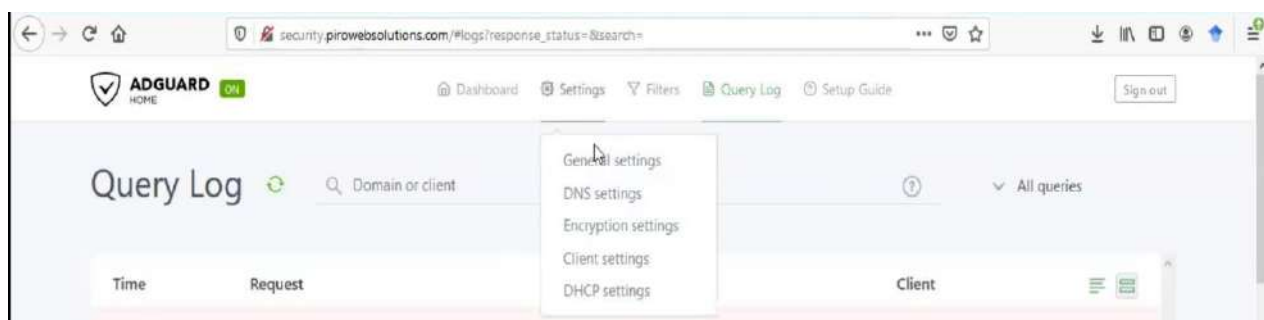


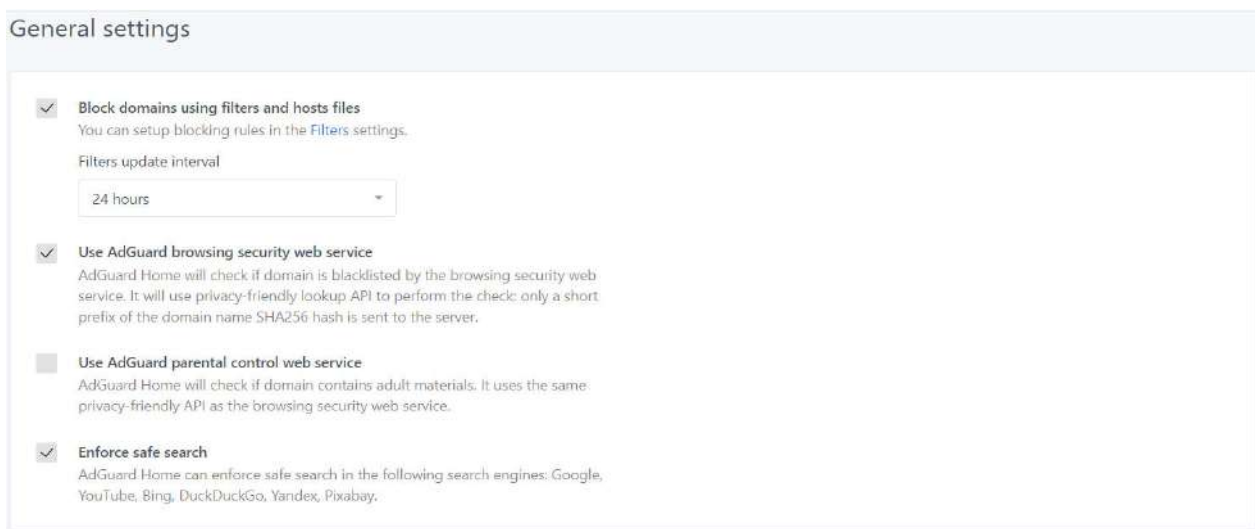
Figure 3: Settings Options

The different settings possible in this model are:

- General
- DNS
- Encryption
- Client
- DHCP

The different features of each of these settings are discussed below.

**General Settings** - The general settings features are shown in figure 4 (a), (b), (c) where the different options possible are displayed.



The figure consists of two screenshots from a web interface. The top screenshot is titled 'Logs configuration' and includes a checked 'Enable log' checkbox, an unchecked 'Anonymize client IP' checkbox (with a sub-note: 'Don't save the full IP address of the client in logs and statistics'), and radio buttons for 'Query logs retention' with '90 days' selected. Below are 'Save' and 'Clear query logs' buttons. The bottom screenshot is titled 'Statistics configuration' and includes a note 'Statistics retention: If you decrease the interval value, some data will be lost', followed by radio buttons for retention intervals with '90 days' selected. Below are 'Save' and 'Clear statistics' buttons.

Figure 4 (a, b, c): General Settings of the Model

Most of the options are self-explanatory like enabling safe search options, how long the model needs to store the statistics, query log retention details and so on.

**DNS Settings** - The DNS refers to the domain name system that acts like the phone book of the internet. The various DNS settings incorporated are shown below.

The screenshot shows the 'DNS settings' page. Under 'Upstream DNS servers', there is a text input field containing 'https://dns10.quad9.net/dns-query'. Below this, there are three radio button options: 'Load-balancing' (selected), 'Parallel requests', and 'Fastest IP address'. Each option has a brief explanatory text below it.

Figure 5: DNS Settings – Upstream DNS Servers

Starting with the first parameter that can be changed, which is the upstream domain name system servers. AdGuard Home refers to a DNS proxy which routes domain name system requests from the user to upstream servers. The customer can change multiple upstream servers or perhaps a domain name system server for AdGuard Home settings to search selected urls. If this option is kept empty, AdGuard Home will automatically use Quad9. The client, on the other hand, has the choice of picking some other server.

**The next options are:**

- **Load Balancing:** If the user has a fast and stable internet connection, no changes are required in load balancing.
- **Parallel Requests:** If the user has an inconsistent Internet or are using numerous unstable DNS servers at the same time, then, the parallel requests option can be used.
- **Fastest IP address:** If a country uses IP blocking, switching to the fastest IP address makes sense (such as the cases of Russian Roskomnadzor blockings, The Great Firewall of China, and so on). It will help in discovering not just the fastest but also the most widely accessible address in this case. Please remember that

a domain name system server isn't a virtual private network, there could be instances when no Internet Protocol address is available.

Examples:

1. 94.140.14.140 - regular DNS (over UDP)
2. tls://dns-unfiltered.adguard.com - encrypted DNS-over-TLS
3. https://dns-unfiltered.adguard.com/dns-query - encrypted DNS-over-HTTPS
4. quic://dns-unfiltered.adguard.com:784 - encrypted DNS-over-QUIC (experimental)
5. tcp://94.140.14.140 - regular DNS (over TCP)
6. edns://... - you can use DNS Stamps for DNSCrypt or DNS-over-HTTPS resolvers
7. [/example.local/]94.140.14.140 - You can specify a DNS upstream for the specific domain(s)
8. # comment - You can specify a comment

**Bootstrap DNS servers**  
Bootstrap DNS servers are used to resolve IP addresses of the DoH/DoT resolvers you specify as upstreams.

9.9.9.10  
149.112.112.10  
2620:fe::fe  
2620:fe::fe:10

**Private DNS servers**  
The DNS servers that AdGuard Home uses for local PTR queries. These servers are used to resolve the hostnames of clients with private IP addresses, for example "102.168.12.34", using rDNS. If not set, AdGuard Home uses the default DNS resolvers of your OS.

Enter one server address per line

Enable reverse resolving of clients' IP addresses  
If enabled, AdGuard Home will attempt to reversely resolve clients' IP addresses into their hostnames by sending PTR queries to corresponding resolvers (private DNS servers for local clients, upstream server for clients with public IP addresses).

**DNS server configuration**

**Rate limit**  
The number of requests per second allowed per client. Setting it to 0 means no limit.

20

Enable EDNS Client Subnet  
If enabled, AdGuard Home will be sending clients' subnets to the DNS servers.

Enable DNSSEC  
Set DNSSEC flag in the outgoing DNS queries and check the result (DNSSEC-enabled resolver is required)

Disable IPv6  
If this feature is enabled, all DNS queries for IPv6 addresses (type AAAA) will be dropped.

**Blocking mode**

- Default: Respond with zero IP address (0.0.0.0 for A; :: for AAAA) when blocked by AdBlock-style rule; respond with the IP address specified in the rule when blocked by /etc/hosts-style rule
- REFUSED: Respond with REFUSED code
- NXDOMAIN: Respond with NXDOMAIN code
- Null IP: Respond with zero IP address (0.0.0.0 for A; :: for AAAA)
- Custom IP: Respond with a manually set IP address

Default  
 REFUSED  
 NXDOMAIN  
 Null IP  
 Custom IP

**DNS cache configuration**  
Here you can configure DNS cache:

**Cache size**  
DNS cache size (in bytes)

4194304

**Override minimum TTL**  
Extend short time-to-live values (seconds) received from the upstream server when caching DNS responses:

Enter minimum TTL (seconds)

**Override maximum TTL**  
Set a maximum time-to-live value (seconds) for entries in the DNS cache.

Enter maximum TTL (seconds)

Figure 6: The implementation of different options in the model

**Access Settings** - The access settings help in specifying the rules implemented for accessing the DNS server. The options about allowed clients, disallowed clients, and disallowed domains can be found here as well as set here if required.



Figure 7: Access Settings

**Encryption Settings** - The encryption settings here will support both the DNS and admin web interface as shown:

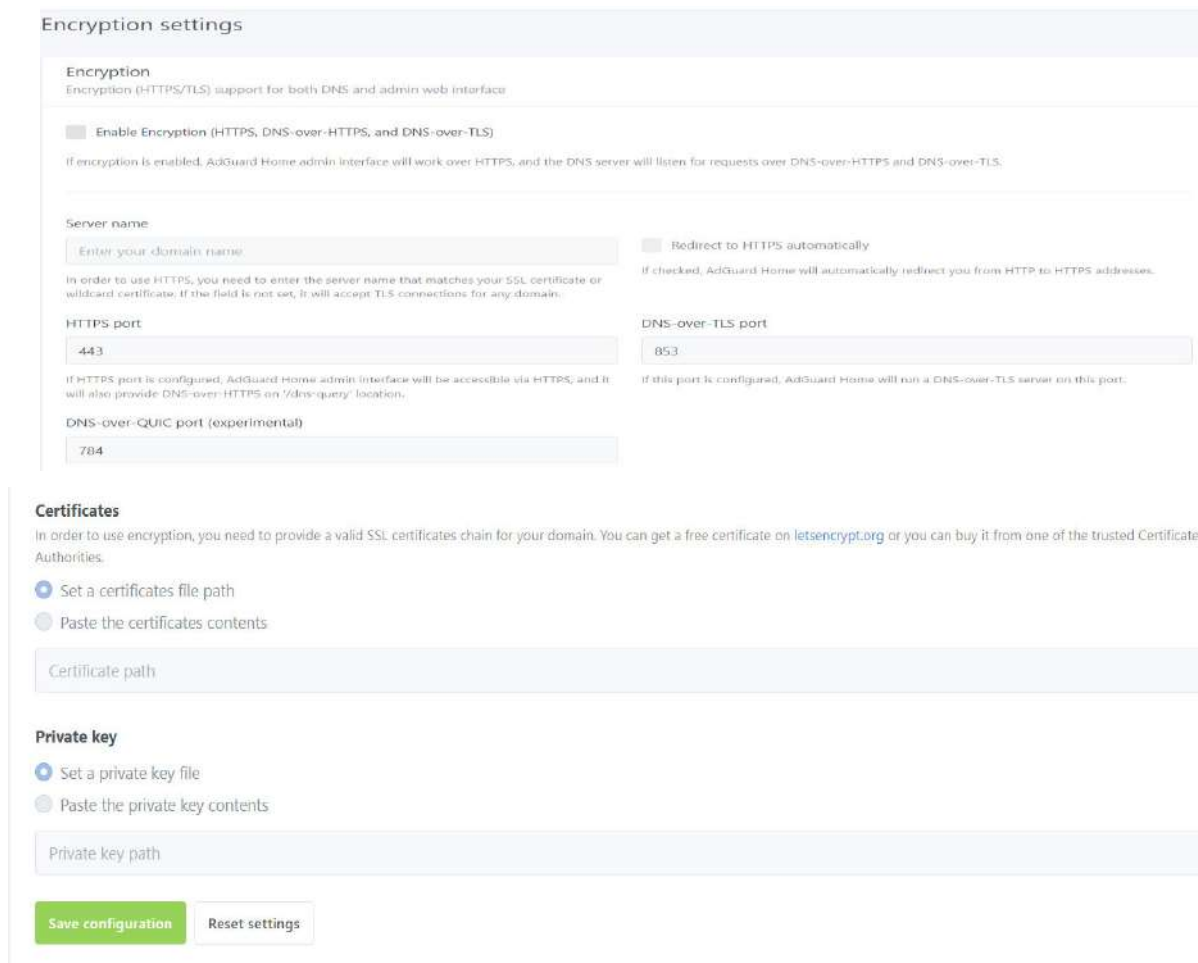


Figure 8 (a), (b): Encryption settings of the model

**Client Settings** - The client settings are mainly provided for configuring devices that are connected to Adguard Home. This will contain the details of the client like name, settings, blocked service, upstream, tags, request counts, and the actions taken in each case. There is also an option for adding the client. The clients (runtime) give the data of the clients that are using this model. However, this is not stored in the configuration.

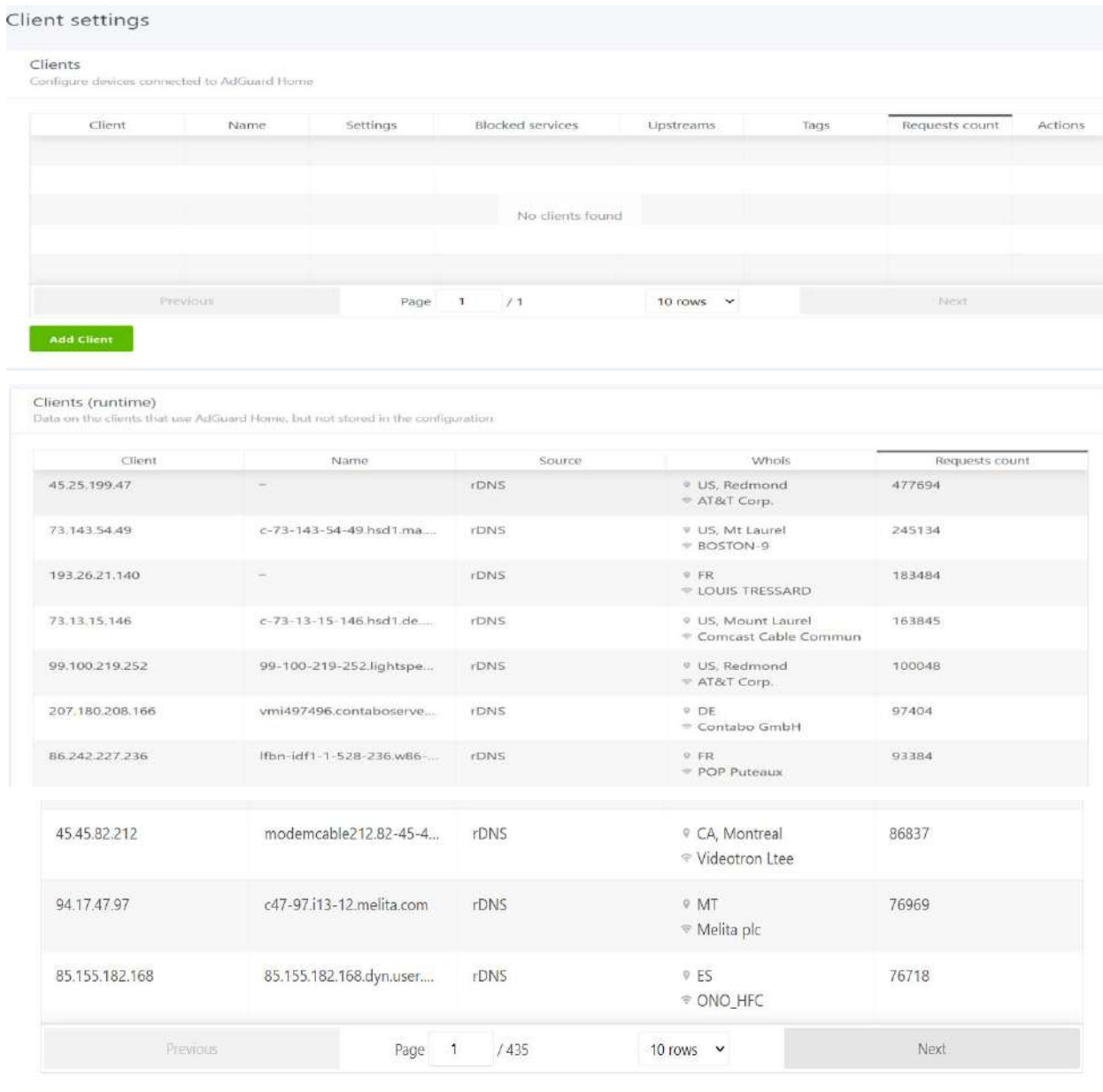
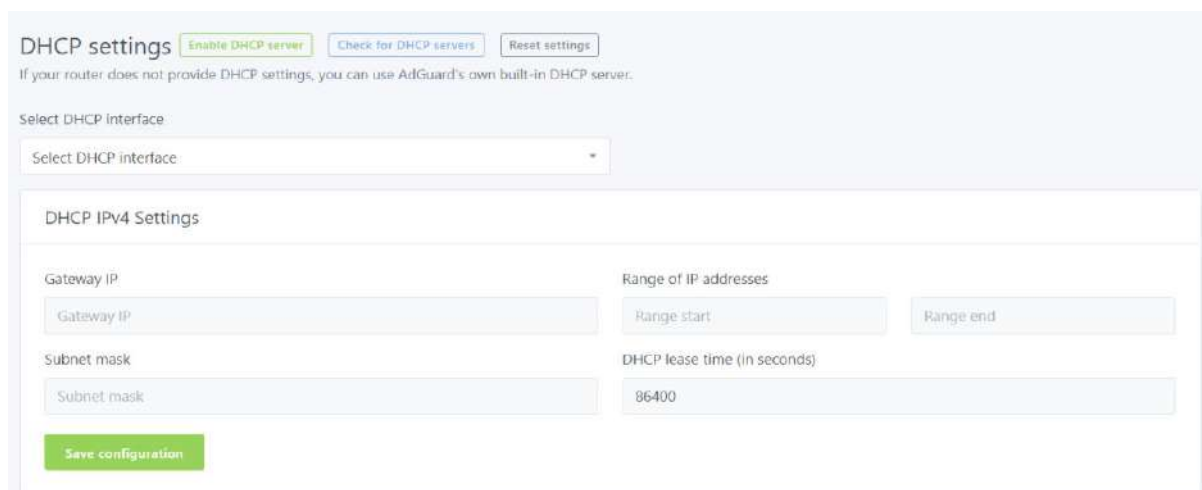


Figure 9 (a), (b): Client Configurations

**Dynamic Host Configuration Protocol (DHCP) Settings** - As previously said, DHCP configuration stands for Dynamic Host Configuration Protocol, which is a standardized network protocol that assigns reusable IP addresses inside the network. The DHCP settings implemented in the model are shown below:





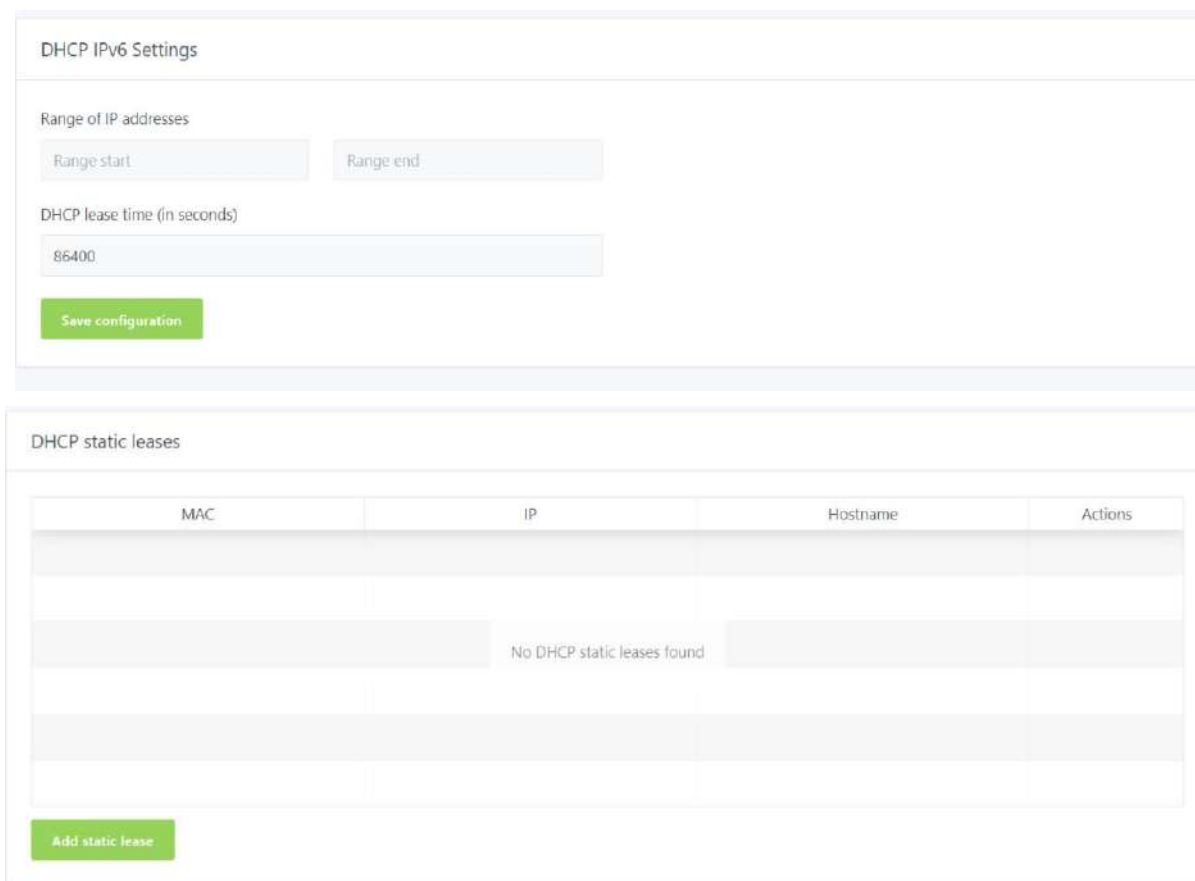


Figure 10 (a), (b), (c): DHCP Configurations

**Filter Options** - An important aspect of a DNS server configuration is DNS filtering. DNS filtering is the process of restricting access to specified websites for a specific reason, most commonly content screening. If a website, or a group of websites, is judged a threat, its IP address is blocked by a DNS filter, and access to it is blocked. Adult, gambling, productivity sinks, and sites considered to represent a major virus risk are all examples of sites that may be blacklisted.

DNS filtering is essential for all organizations because it may drastically minimize the number of threats that a network is exposed to, reducing the remediation workload for MSPs and IT professionals. Effective DNS filtering can keep up to 88 percent of internet-borne malware out of the network. Business owners can regain control of their networks by setting DNS filtering policies to block unwanted access to certain websites and so on.

The different DNS filter settings applied in this research model are shown in the figure below. The filter settings possible are DNS block list, DNS allowlist, DNS rewrites, blocked services, and custom filtering rules.

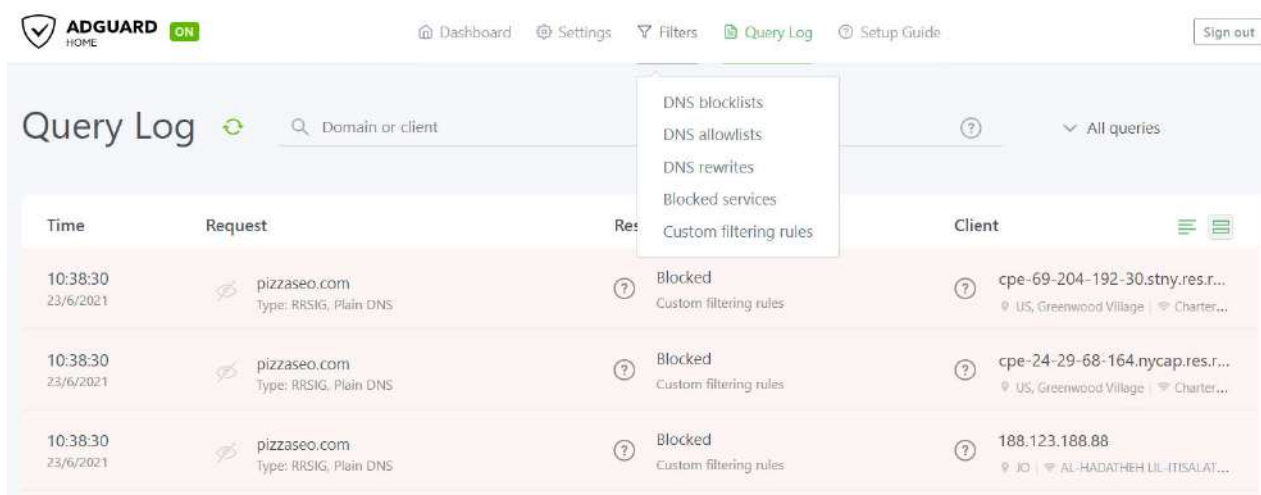
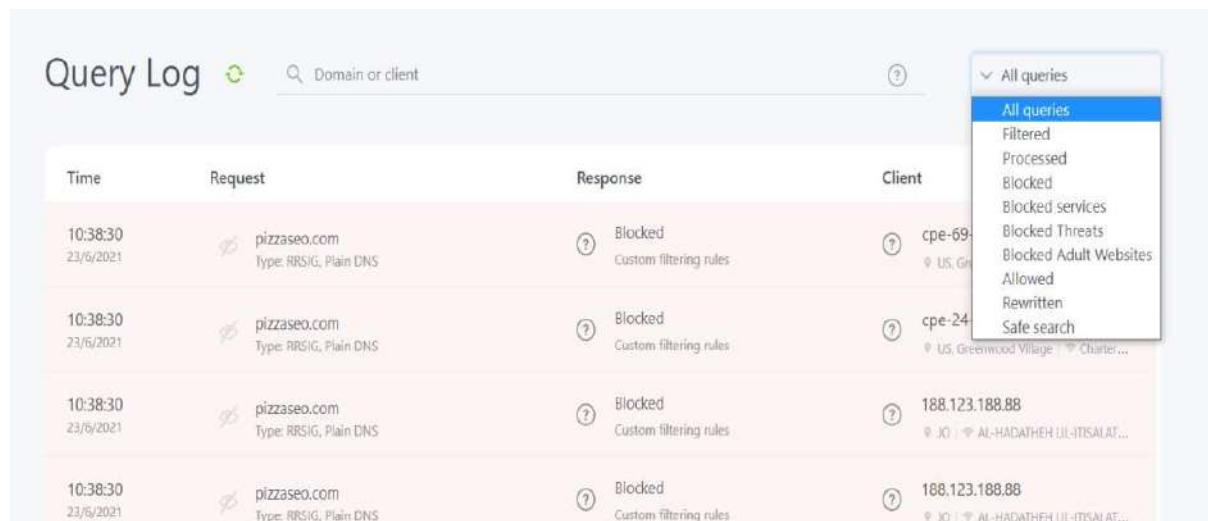


Figure 11: Possible Filter Options Available

**Query Log Options** - As mentioned earlier, the next option in the model designed is the query log options. The figure below, show the different options available in query logs. There is also a place where the options to be displayed can be filtered - All queries (if all the queries are to be listed), Filtered (showing the queries that were filtered), Blocked (showing the list of queries that were blocked), and so on. In addition, a general search box is provided in which the user can enter a specific domain or client name and obtain the query log for that.



**Figure 12:** Possible Query Log Options Available

Thus, the different aspects of the designed hybrid model have been presented along with the different features available in this model. It is possible to obtain real-time data in this by using the "refresh statistics" option. This helps to clearly assess the security threats that are occurring.

## DISCUSSIONS

Even though Domain Name System (DNS) is an important factor of the website, most people from outside networking are probably unaware that they utilize it on a daily basis to complete tasks, check email, as well as waste precious time on their smartphones.

Even at the most fundamental level, the domain name system is a database of names which match numerical values. The digits in this example correspond to internet protocol addresses that are used by systems to communicate with each other. The directory of domain name system, that translates names to digits, is not entirely confined to a single dark portion of the web. Only one directory would've been big enough, including over a million web addresses. Just like with the World Wide Web, the directory is distributed globally and is maintained upon domain name servers which connect with each other on a continuous basis to provide changes as well as redundancy.

DNS is organized in a hierarchical framework that helps in maintaining proper operation. As an illustration, suppose you desired to access networkworld.com.

As explained previously, a recursive resolver is used to make an initial request for internet protocol address. To resolve the domain name (networkworld.com) to its IP address, the recursive resolver determines which further DNS servers to query. This request is directed to a root server, which is knowledgeable about top-level domains such as .com, .net, and .org, and also country-specific domains such as .uk (United Kingdom) and .cn (China). Since root servers are distributed throughout the worldwide, the system will typically direct you to one that is spatially closest to you.

After reaching the appropriate root server, the request is routed to TLD (top-level domain) name server that stores information about SLD (second-level domain), the words preceding the .org, .com, as well as .net such as the information for networkworld.com is "networkworld". The request is then routed to DNS that maintains information about the site and its IP address. After determining the IP address, it is sent to the customer, who may now use this to visit the web. This all occurs within milliseconds.

DNS is one of a collection of so-called "utility protocols" which facilitate Electronic communications. These are strong protocols which maintain traffic flow and server communication, although the majority of users are ignorant of their presence. While the Network Time Protocol, Border Gateway Protocol, as well as, obviously, Domain name system all seem to be essential for keeping the Internet's availability, they are often outside the

purview of security personnel. The administrators who install and operate the systems which support such protocols are frequently unaware of the security risks associated with them.

As a result of the absence of security understanding and the comparative secrecy of such protocols, they are easy to attack, as cybercriminals have learned. As a consequence of this seeming gain, a black hat community has seen a considerable increase in exploitation as well as vulnerabilities study in such protocols. Additionally, security community has conducted much research on how to effectively protect such processes. However, there is a substantial divergence between the study conducted by researchers and the persons who handle the operations on a daily basis. This creates plenty of possible DNS security issues. Among the numerous available options, AdGuard DNS enables the formulation and construction of a private DNS.

Without the need to install any application, AdGuard DNS is a reliable solution for blocking tracking and ads on the website. It's easy to use, maintains your confidentiality, is entirely free, and it can be downloaded on any computer. It, among several other things, bans advertisements, hackers, malicious links, and pornographic stuff (optionally).

Whenever the server is configured with the desired DNS, it answers with an unfilled response whenever a website or app submits an ad requests. AdGuard provides a regularly updated directory of domain names which serve advertising, trackers, and scams. AdGuard DNS is available in two configurations. In Default Setting, advertisements, counters, malicious, and fake websites are all banned. Along with censoring pornographic content as well as allowing appropriate search on your website, Family Mode does the same thing. AdGuard DNS is compatible with a wide range of devices, including smartphones and tablet computers. There are no restrictions on the type of equipment that can be used.

The essential nature of DNS security cannot be overstated. Due to the numerous network and security issues which exist, this study has built a Private DNS which provides the user with complete control over the network and its operations. They do not simply spoon-feed customers filtered output; they equip them with the necessary tools to create the Website effectively. The essential nature of DNS security cannot be overstated. Due to the numerous network and security issues which exist, this study has built a Private DNS which provides the user with complete control over the network and its operations.

All requests will be routed through a dedicated DNS server that will filter out all advertising and pop - ups from the source. Similar to pop-up blockers, adblock browser plugins work similarly. Everything advertising-related is prohibited. The primary advantage of this functionality is that it enables rootless system-wide ad banning on Android devices. Such that, once configured, all of your applications as well as websites will be ad-free as well as powered by adblockers.

#### **MODEL BENEFITS**

- It does not require the installation of any programs.
- All modern DNS privacy protocols are supported, including DNSCrypt, DNS-over-HTTPS, and DNS-over-TLS.
- It has two modes: "Default," which blocks adverts and trackers, and "Family," which adds parental control features to the same functionality.

Thus, the results of the model designed have been presented here and the various aspects and features discussed.

#### **CONCLUSION**

Intrusion detection systems (IDSs) attempt to detect attacks while they occur or after they have occurred. IDSs collect network traffic data from a specific location on the network or computer system and utilize it to secure the network. Misuse detection or anomaly detection are two types of intrusion detection systems. IDSs based on misuse detection can only detect known attacks, but IDSs based on anomaly detection can detect novel attacks using heuristic approaches. By merging the two techniques in one system, this study proposes a hybrid IDS. The hybrid IDS is created by merging anomaly-based IDSs such as packet header anomaly detection (PHAD) and network traffic anomaly detection (NETAD) with the open-source misuse-based IDS Snort. The MIT Lincoln Laboratories network traffic data (IDEVAL) is used as a testbed for the hybrid IDS. The number of assaults identified by a misuse based IDS on its own is compared to the number of attacks detected by a hybrid IDS created by combining anomaly-based and misuse based IDSs, demonstrating that the hybrid IDS is a more powerful system.

## REFERENCES

1. Overview | AdGuard Knowledgebase. (2021). Adguard. <https://kb.adguard.com/en/dns/overview>
2. T. April, L. Chapin, kc claffy, C. Hesselman, M. Kaeo, J. Latour, D. McPherson, D. Piscitello, R. Rasmussen, and M. Seiden, "The DNS and the Internet of Things: Opportunities, Risks, and Challenges", SSAC report SAC105, June 2019, <https://www.icann.org/en/system/files/files/sac-105-en.pdf>
3. K. Rose, S. Eldridge, and L. Chapin, "The Internet of Things: an Overview", ISOC, Oct. 2015, <http://www.internetsociety.org/sites/default/files/ISOC-IoTOverview-20151221-en.pdf>
4. N. Apthorpe, D. Reisman, N. Feamster, "A Smart Home is No Castle: Privacy Vulnerabilities of Encrypted IoT Traffic", Workshop on Data and Algorithmic Transparency (DAT '16), New York University Law School, November 2016, <https://arxiv.org/abs/1705.06805>
5. T. Böttger, F. Cuadrado, G. Antichi, E. Leão Fernandes, G. Tyson, I. Castro, and S. Uhlig, "An Empirical Study of the Cost of DNS-over-HTTPS", IMC'19, Oct. 2019, Amsterdam, the Netherlands
6. AdGuard Home: In-depth overview. (2021). AdGuard Blog. <https://adguard.com/en/blog/in-depth-review-adguard-home.html#features>

---

---

## **The Study of Selected Initial Public Offering in India for a Period of 3 Years from 2019 To 2021**

**Monika Gorkhe and Anchal Garg**

Dr. D Y Patil Institute of Management Studies, India

### **ABSTRACT**

From 2019 to 2021, the researcher looked at IPO performance on the day of listing as well as from the issue price to the last trade price in India. In this study, we selected six firms from each year from 2019 to 2021, three of which performed exceptionally well on the day of listing, and three of which did not do well on the day of listing. It has been discovered that firms that did not perform well on the initial public offering (IPO) day may perform well in the secondary market and that companies that earned the highest return on the initial public offering (IPO) day may not earn the same proportion of earnings in the future. As a result, a thorough grasp of the firm in which the investor is investing is critical. They should also know when to enter and exit the stock market in order to maximize their profits.

Keywords: Initial Public Offering, Issue Price, Last Trading Price, Listing Day Gain.

### **INTRODUCTION**

The Financial Market may be defined as a large group of people who get together to trade financial assets. Financial Markets are a type of financial system that connects firms in need of capital with investors wanting to engage in a profitable venture. As a result, it supports institutions and organizations who require funds in obtaining them, as well as the general public in saving. There are two sorts of financial markets: primary and secondary markets. The primary market is where securities are originated; corporations sell (float) new stocks and bonds to the general public for the first time during this market. A primary market is exemplified by an initial public offering or IPO. Investors acquire and deal in securities they already possess on the secondary market. It's also known as the stock exchange. National exchanges such as the New York Stock Exchange (NYSE) and the Nasdaq Stock Market (NASDAQ) are secondary markets.

When a business needs money, the typical line of action is to go to the bank. Banks, on the other hand, may not be willing to offer large sums of money for a long period, especially if the returns are not guaranteed. The greatest way to raise money is through the sale of stock, and the answer is the initial public offering. The major goal is to make it easier for savers to transfer money to entrepreneurs who want to start new businesses or grow and diversify current ones. The primary market is used by both the state government and the private sector to raise revenue. To put it another way, the Primary Market, together with the Securities Market, is a vital aspect of a country's capital market.

The Initial Public Offering (IPO) is a company's first public offering of securities after its formation. Going public or issuing an initial public offering (IPO) is the process of converting a business held by one or more persons into a business owned by many. It means selling equity securities to the public which means exchanging money for a portion of the company's ownership (stock). Because investors are given ownership in the form of equity shares, the IPO dilutes ownership stakes and diffuses corporate control. Significant access to investment funds, some stock price support after the listing, and so on are some of the benefits of becoming public. While there are certain drawbacks to going public, such as the high cost of an IPO for small businesses, etc. SEBI regulates the Indian capital market, including initial public offerings (IPOs). When it comes to launching an IPO in the market, there is a set of norms and guidelines that every firm must follow. The performance of an initial public offering (IPO) may be influenced by a variety of factors such as the size of the offering, the time it takes to list, the pricing, and so on.

The number of initial public offerings (IPOs) issued in a given year reflects an investor's risk appetite. Investor sentiment may have an impact on market performance, causing stock prices to rise or decrease. Investor feelings can influence the IPO issue, and so can the business age, issue size, subscription rate, issue managers reputation, market conditions, promoters' holdings, firm returns, market cycle, and IPO grading, among other factors. One of the most critical aspects impacting the performance of an IPO is the issue price. The current research examines the performance of initial public offerings (IPOs) on the BSE/NSE on their listing day, as well as the performance of IPOs from the issue price to the last trading price for a period of 3 years from 2019 to 2021.

## LITERATURE REVIEW

IPO is at the forefront of innovation in the financial market with the aim to increase return and reduce risk. Investors from all around the world have been attracted to these products. IPO plays an important role in the financial market as it is one of the most preferred tools for investment by investors in the market. (Muliya, 2015)

The process of raising funds through an initial public offering (IPO) is quite complicated. It involves the analysis and execution of many commercial laws pertaining to IPOs-Prospectus. SEBI Guidelines and Eligibility Criteria are very important to be understood. It is necessary to fulfill these criteria by the organization to raise capital. (Nadkarni, 2011)

This paper studied the performance of IPO from the issue price to last trade price in India during, 2013 to 2015, listed in National Stock Exchange (NSE) India. The researcher found that there is on average a significantly positive return. The investment done in the securities by the investors is mainly done only by the image of the company but not based on the fundamental analysis. (Ambily, 2016)

The relation between return on listing and issue price, issue size, business age, and issue capital listing were found to be negative by the researcher. It was discovered that the relationship was statistically significant. The relation between return on listing and foreign equity issue rating, on the other hand, was discovered to be positive. This study also revealed that in the long term (five years after listing), the return on IPOs falls dramatically, with returns becoming negative from the second to the fifth year after listing. (Madan, 2003)

The short-run performance of the companies is examined in this study in order to understand the anomaly of unusual returns, as well as the long-term performance of the IPOs in order to assess their long-term performance. The research period spans from January 2013 to December 2014. The analysis involves nine companies that are publicly traded on the National Stock Exchange. (Poornima, 2016)

They presented a weighted sentiment score to examine investor fundamental attribution bias in book-building against fixed-price Initial Public Offerings (IPOs). The researchers looked at data from 1995 to 2007. The findings demonstrated that IPO cycles drove sentiment, which is consistent with behavioral IPO literature. (Gupta & Samdani, 2010)

The performance of IPOs issued through the book-building procedure in India from 1999 to 2006 is examined in this paper. The sample includes 156 companies that used the NSE's book building route to sell their stock. The IPOs on average provided positive returns to investors upon listing, and the opening returns accounted for a major portion of the closing day returns on the listing day. In the long run, IPOs provided favourable returns for the first twenty-four months, but they then underperformed the market. (Kumar, 2010)

The research aims to measure the value of the share premium and price on the day of the IPO, as well as the IPO return's progressive rise. The Wilcoxon Signed Rank Test is used to assess the short-term and long-term performance of IPO returns. Twenty-six firms are included in the sample, all of which had successful IPOs in 2016. (Khan, 2021)

During the first 240 trading days after their IPO DATES, the price clustering of initial public offerings in the secondary market trading. The study shows that the substantial price differential between IPOs in the primary market and matching equities in the secondary market essentially vanishes on the first trading day following the IPO. (Wang, 2010)

They investigated approximately 92 initial public offerings between 1999 and 2003. They investigated the impact of the book-building mechanism on IPO pricing and discovered that book-built issues had less underpricing than fixed-price issues. They also observed less underpricing for larger issues and more underpricing for smaller issues. (Madhusoodanan, 2004)

### **There are 2 methods of pricing an IPO-**

- 1. Fixed price issue-** If the shares are issued at a set price in an initial public offering (IPO), this is referred to as a Fixed price issue. This is the second most popular method of launching an IPO. The issuer must provide a logical and appropriate justification for the price established in the offer document. In general, corporations use fixed pricing issues only when the management believes that a reasonable price can be determined among them without testing the market.
- 2. Book building method-** A process of price discovery is called book building. It's a system in which investors submit bids at various levels above or equal to the floor price during the IPO's open period. After the bid deadline, the price of the offer is determined.

	Fixed Price Issue Method	Book Building Method
<b>Offer Price</b>	The price at which the securities are offered and would be allotted is made known in advance to the investors	A 20% price band is offered by the issuer within which investors are allowed to bid and the final price is determined by the issuer only after the closure of the bidding
<b>Demand</b>	Demand for the securities offered is known only after the closure of the issue	Demand for the securities offered, and at various prices, is available on a real-time basis on the BSE/NSE website during the bidding period
<b>Payment</b>	100% Applications Supported by Blocked Amount	100% Applications Supported by Blocked Amount
<b>Reservations</b>	50% of the shares offered are reserved for applications below Rs. 2 lakh and the balance for higher amount applications.	50% of shares offered are reserved for QIBS, 35% for Non-Retail and 15% for Retail Investors

### PROBLEM STATEMENT

Many recent studies have focused on determining the long-term success of initial public offerings (IPOs) rather than the performance on the day they are listed on the stock exchange. As a result, the present research focuses on the performance of initial public offerings (IPOs) on the day of the Issuance, as well as the performance of IPOs from the issue price to the last trading price. We learned during our research that the price mechanism is also important during the IPO process. We also determined that some of the initial public offerings were under-priced, resulting in poor performance on the first day of trading.

### OBJECTIVES

- To study the performance of initial public offerings (IPOs) on their first day of trading.
- To assess the performance of the IPOs from the issue price to the last trading price, as well as the percentage change.
- To understand the methods of pricing an IPO.

### HYPOTHESIS

- **Null Hypothesis-** There is no significant difference in the performance of the IPO on the listing day of the IPO to the last trading price of the stock.
- **Alternative Hypothesis-** There is a significant difference in the performance of the IPO on the listing day of the IPO to the last trading price of the stock.

### RESEARCH METHODOLOGY

This research project is both descriptive and analytical. We used secondary data from websites like chittorgarh.com and moneycontrol.com to analyse the success of the IPOs. To examine the performance of IPOs, we have chosen 6 companies from each year from 2019 to 2021. We've chosen the top three firms that did the best on the first day of trading and the top three companies that underachieved on the first day of trading.

### DATA ANALYSIS

#### 1. Performance of IPOs on Listing Day

The issue price and the closing price were used to assess the IPO's performance on the day of its launch. The performance can be categorized as under-pricing or over-pricing based on the increase or decrease in stock prices on the listing day. When stock prices close above the issue price, they are considered under-priced, and when they close below the issue price, they are considered over-priced.

The issue price is the price at which the corporation sells its stock to the public. The price might be comparable, higher, or lower. When shares are issued, the price may change depending on market demand.

The price at which a stock closes on its first day of trading on the stock exchange is referred to as the listing day close. This allows us to see how the stock performed at the time of its initial public offering. We may calculate the investor's gain on the first day of the listing by using the closing price on the listing day.

The following formula can be used to compute the gain on the listing day of the IPO:

$$IR_i = P_{i1} - P_{i0} / P_{i0}$$

Where,

$IR_i$  = Gain on the first day of trading.

$P_{i1}$  = Closing price of the IPO on the first day of trading.

$P_{i0}$  = Issue price of the IPO.

Performance of IPO on the listing day in 2019				
Company name	Issue price ( $P_{i0}$ )	Listing Day Close ( $P_{i1}$ )	Listing Day Gain ( $IR_i$ )	Performance
IRCTC Limited	320	728.6	127.69%	Under-priced
CSB Bank Limited	195	300.1	53.90%	Under-priced
Ujjivan Small Finance Bank Ltd	37	55.9	51.08%	Under-priced
Prince Pipes and Fittings Ltd	178	166.6	-6.40%	Over-priced
Sterling and Wilson Solar Ltd	780	725.35	-7.01%	Over-priced
Xelpmoc Design and Tech Limited	66	59.85	-9.32%	Over-priced

Table 1.1

### INTERPRETATION

It can be seen from the above table that IRCTC Limited had a gigantic gain of 127.69 percent on the IPO's listing day, whereas Xelpmoc Design and Tech Limited had a loss of 9.32 percent. As a result, we might conclude that the IRCTC limited issuance price was under-priced. They should have considered market demand while determining the issue's pricing.

Performance of IPO on the listing day in 2020				
Company name	Issue price ( $P_{i0}$ )	Listing Day Close ( $P_{i1}$ )	Listing Day Gain ( $IR_i$ )	Performance
Burger King India Limited	60	138.4	130.67%	Under-priced
Happiest Minds Technologies Ltd	166	371	123.49%	Under-priced
Mrs. Bectors Food Specialities Ltd	288	595.55	106.79%	Under-priced
SBI Cards and Payment Services Ltd	755	683.2	-9.51%	Over-priced
Angel Broking Ltd	306	275.85	-9.85%	Over-priced
UTI Asset Management Company Ltd	554	476.6	-13.97%	Over-priced

Table 1.2

### INTERPRETATION

It can be seen from the above table that Burger King India Limited had a gigantic gain of 130.67 percent on the IPO's listing day, whereas UTI Asset Management Company Ltd had a loss of 13.97 percent. As a result, we might conclude that the Burger King India Limited issuance price was under-priced. They should have considered market demand while determining the issue's pricing.

Performance of IPO on the listing day in 2021				
Company name	Issue price ( $P_{i0}$ )	Listing Day Close ( $P_{i1}$ )	Listing Day Gain ( $IR_i$ )	Performance
Sigachi Industries Limited	163	603.75	270.40%	Under-priced
Paras Defence and Space Technologies Limited	175	498.75	185%	Under-priced
Latent View Analytics Limited	197	488.6	148.02%	Under-priced
Shriram Properties Limited	118	99.4	-15.76%	Over-priced
Rategain Travel Technologies Limited	425	340.5	-19.88%	Over-priced
One 97 Communications Limited	2150	1564.15	-27.25%	Over-priced

Table 1.3

### INTERPRETATION

It can be seen from the above table that Sigachi Industries Limited had a gigantic gain of 270.40 percent on the IPO's listing day, whereas One 97 Communications Limited had a loss of 27.25 percent. As a result, we might conclude that the Sigachi Industries Limited issuance price was under-priced. They should have considered market demand while determining the issue's pricing.



## 2. Performance of IPO from the issue price to last trading price and percentage change

In this study, we compared the IPO's issue price to the stock's last trading price to see how it performed in the short term. We also computed the percentage change in order to see how much the stock has changed over time.

**Issue price**-Prior to the new issue trading on the secondary market, the price at which the new security will be delivered to the general public. Also referred to as the "offering price."

**Last trading price**-The last traded price is the price at which the financial asset was traded last. The occurrence of the last traded price, or LTP, is determined by market liquidity, and the last traded price, or LTP, might have occurred a few seconds or even a day ago.

**Percentage change**- It is the change in the stock price from the day it was issued to the last trading price over a period of time. The following formula may be used to compute it:

$$\text{Percentage change} = (\text{Last Trading Price} - \text{Issue Price} / \text{Issue Price}) * 100$$

PERFORMANCE FROM ISSUE PRICE TO LAST TRADING PRICE IN 2019			
Company Name	Issue Price	Last Trading Price	Percentage Change
IRCTC Limited	320	861.35	169.17
CSB Bank Limited	195	241.1	23.64
Ujjivan Small Finance Bank Ltd	37	19.75	-46.62
Prince Pipes and Fittings Ltd	178	701.9	294.33
Sterling and Wilson Solar Ltd	780	396.05	-49.22
Xelpmoc Design and Tech Limited	66	379	474.24

Table 2.1.

### INTERPRETATION

From the above table, it is seen that Xelpmoc Design and Tech Limited has the highest percentage of 474.24 percent change from the day of issue to the last trading price and Ujjivan Small Finance Bank Ltd and Sterling and Wilson Solar Ltd have performed badly over the period of time with a loss of 46.62 percent and 49.22 percent respectively.

PERFORMANCE FROM ISSUE PRICE TO LAST TRADING PRICE IN 2020			
Company Name	Issue Price	Last Trading Price	Percentage Change
Burger King India Limited	60	135.4	125.67%
Happiest Minds Technologies Ltd	166	1267.05	663.28%
Mrs. Bectors Food Specialities Limited	288	371.95	29.15%
SBI Cards and Payment Services Ltd	755	850.5	12.65%
Angel Broking Ltd	306	1515.15	395.15%
UTI Asset Management Company Ltd	554	1036.85	87.16%

Table 2.2

### INTERPRETATION

From the above table, it is seen that Happiest Minds Technologies Ltd. has the highest percentage of 663.28 percent change from the day of issue to the last trading price and SBI Cards and Payment Services Ltd and Mrs. Bectors Food Specialities Limited have not performed great over the period of time with a gain of 12.65 percent and 29.15 percent respectively.

PERFORMANCE FROM ISSUE PRICE TO LAST TRADING PRICE IN 2020			
Company Name	Issue Price	Last Trading Price	Percentage Change
Sigachi Industries Limited	163	366.3	124.72%
Paras Defence and Space Technologies Limited	175	689.25	293.86%
Latent View Analytics Limited	197	552.45	180.43%
Shriram Properties Limited	118	110.05	-6.74%
Rategain Travel Technologies Limited	425	431.55	1.54%
One 97 Communications Limited	2150	959.9	-55.35%

Table 2.3

## INTERPRETATION

From the above table, it is seen that Paras Defence and Space Technologies Limited has the highest percentage of 293.86 percent change from the day of issue to the last trading price and One 97 Communications Limited and Shriram Properties Limited have not performed great over the period of time with a loss of 55.35 percent and 6.74 percent respectively.

## FINDINGS AND SUGGESTIONS

- Investors buy securities mostly based on the company's image, rather than on fundamental analysis.
- Investors that are looking for a quick return can consider investing in the stock market through an initial public offering.
- Since the primary market is volatile and the shares are being issued for the first time in the market, we can't anticipate the share's stability.
- However, it is believed that with more risk comes greater reward, thus an investor might participate in a company's initial public offering (IPO) by doing a thorough examination of the company's history and performance.
- Investors should pick IPOs of firms that have continuously performed successfully in order to make the most money from their investment.
- An initial public offering (IPO) might be a fantastic way for a beginner to learn how to invest in the stock market.

## CONCLUSION

The study attempted to assess IPOs success in both the primary and secondary markets in order to determine IPO performance growth. In the primary market, we looked at IPO performance on the day they were listed, and in the secondary market, we compared the issue price to the last trading price to see how much the stock had changed since the day it was issued to the last trading price.

It was observed that even though the stock may not perform well on the day of its initial public offering, it might provide excellent returns to its investors in the secondary market. Xelpmoc Design and Tech Limited, Prince Pipes and Fittings Ltd, and Angel Broking Ltd did not perform well on the day of their initial public offering, but they are performing well on the secondary market and earning larger returns for their investors. While stocks like Ujjivan Small Finance Bank Ltd and Mrs. Bectors Food Specialities Limited performed well on the day of their first public offering, they are not providing investors with substantial returns in the near run.

In India, investment has become more of a security requirement than a way of life. As a result, it is critical for an investor to understand when to invest in a firm and when to quit a company based on fundamental and technical research. In addition, the investor should be knowledgeable of the company's history and performance. To invest in the company's stocks, it is critical to have a thorough understanding of the stock market.

## LIMITATION AND FUTURE OF THE STUDY

The research is restricted to six firms from each year from 2019 to 2021 that performed well on the first day of trading and companies that did not do well on the first day of trading. This research may be broadened to include all initial public offerings (IPOs) that have been listed on the stock exchange. This analysis may also be done on the basis of different sectors to see which sectors' IPOs do well in comparison to others.

## REFERENCES

1. Ambily. (2016). A study on Performance of Ipo's under NSE from issue price to last trading price in the year 2013-2015. *Global Journal of Finance and Management*.
2. Gupta, & Samdani. (2010). Is investor sentiment driven by IPO pricing mechanism? Evidence from India.
3. Khan, Z. A. (2021). A Study of Stock performance of select ipo in india. *Academy of Accounting and Financial Studies Journal*.
4. Kumar, S. (2010). Short and Long Run Performance of ipos in indian market. *indian institute of management, kolkata*.
5. Madan, A. A. (2003). Investments in IPOs in the Indian Capital Market. *Bimaquest*.

6. Madhusoodanan. (2004). Ipo underpricing, issue mechanisms and size. Institue of financial management and research, chennai.
7. Muliya. (2015). A study of investors perception on ipo and ipo performance in the stock market.
8. Nadkarni. (2011). Study of Initial Public Offering.
9. Poornima, H. D. (2016). Study on the performance of initial public offering of companies. International Journal of Research in Finance & marketing.
10. Wang, Q. (2010). Price clustering of IPOs in the secondary market. Applied Economics Letters.

## Science Ethics are Included in the Science Book of Iraq for the Firstgrade in Middle School

Noor Mohammed Kadhim<sup>1</sup>, R. Meenakshi<sup>2</sup>, Mustafa Mahdi Abdulridha<sup>3</sup> and S. Pushparaj<sup>4</sup>

<sup>1,2</sup>Department of Education, Madurai Kamaraj University, Madurai, Tamil Nadu, India

<sup>3</sup>Department of Economics, Madurai Kamaraj University, India

<sup>4</sup>School of Economics, Madurai Kamaraj University, India

### ABSTRACT

Great and rapid scientific developments witnessed and witnessed by the world added a huge amount of information and scientific knowledge, and produced advanced technical products that facilitated many aspects of life in different and diverse disciplines - and this would require human energies that include all disciplines on the one hand, and on the other hand, would require human energies that include all disciplines on the one hand, and on the other hand, would require human energies that include all disciplines on These findings have resulted in scientific innovations that are directly related to morals and social values, and because the educational system is a part of this vast world, it has become necessary to keep up with and absorb these scientific developments, as well as to assume its responsibilities in the preparation of these diverse human energies, This preparation will not be possible unless all of the necessary materials are available. Some of the fundamental features of the school curriculum are reflected in the material (the textbook), the instructor who implements it, and the student whose curriculum attempts to bring about the required adjustments in order to grow in all of its dimensions. As a result, our educational system today urgently requires educational content that accommodates this wide range of knowledge, as well as the correct scientific methods for dealing with technological devices and tools, with special attention paid to anything that contradicts morals and sound social values, and efforts made to incorporate them into the school curriculum. In addition, this approach must aid in the preparation of teachers with a strong scientific culture.

Keywords: Science Ethics, Science Book, First Middle School

### NEED FOR THE STUDY

Because we live in the modern world, with its breadth of knowledge in all areas and its vast and rapid scientific changes, it is critical that the curriculum take these changes into account in order to raise a generation capable of keeping up with developments and confronting the challenges that it faces, in a scientific spirit characterized by flexibility and adaptation to what happens and will happen. The classroom curriculum represented by the book, as well as the teacher who is sprinting out, are undeniably linked, They will be the container that accommodates all the changes that occur, and therefore the process of analyzing the curriculum content is one of the processes that the educational process is indispensable for, because of its importance in revealing the extent of what that content contains of new issues and then knowing what it lacks in cognitive developments, and knowing the possibility of merging them, or modifying or deleting some of the information contained in them that may not be compatible with the spirit of the times.

### (Rabie, 2006: 11)

The Science Book is well-known as one of the branches of natural sciences, with a significant impact and role in a variety of sectors of life as a result of the numerous and significant innovations it has presented to serve society and attain human well-being and happiness. This science is concerned with researching the qualities of matter, its composition, basic changes that occur in it, and changes in its exterior and interior properties, as defined by numerous specialist scientists.

### (Mohammed, 1989: 2)

During the last quarter-century, a wave of scientific and technological activity swept the developed world, and as a result of the extension of this scientific activity to various fields of life, it altered people's thinking in problem-solving, and advanced peoples were able to eliminate many harmful traditions, myths, and false beliefs that stymied society's progress, thanks to the spread of scientific culture (Atef, 1995: 41), Therefore, it has become necessary for students to acquire the dimensions of scientific culture in the field of science, in order to be able to keep pace with the rapid and diverse scientific developments and technological innovations in all countries of the world. This is achieved through the contents of the curricula of these dimensions related to scientific developments and the formulation of educational goals in their light. Teaching science in the contemporary time seeks, among its main objectives, to provide the learner with scientific culture, linking him

to the world in which he lives, the reality of his environment, his daily life and his interests, to feel the value of what he learns His motivation increases and his scientific tendencies and trends grow.

**(Al-Hudhaifi, 2010: 6)**

Many countries around the world have recognized the value of scientific culture for their children and have begun to take steps to include scientific culture standards in their curricula, as this may lead to the preparation of students who are able to use scientific information and appropriate processes in making personal decisions, as well as a sense of attitudes and excitement resulting from an understanding of the natural world, and the expansion of professional opportunities, They appeared with the emergence of contemporary scientific innovations in the fields of science in general, such as the various and varied uses of radioactive elements in civil and military fields, nuclear weapons, ozone layer erosion by some chemicals, global warming, and the expansion of the use of chemicals, carcinogens, and many others, Because such techniques and scientific innovations are a double-edged sword, it has become necessary and very important for curricula to pay attention to the aspect of ethical scientific awareness, in addition to the positives of some of them, there are many ethical problems, It has many virtues and advantages, but it also has disadvantages and flaws that deserve attention and caution, because these issues are directly related to values and morality, and they have prompted much debate among scientific, religious, social, and political communities.

The ethics of science is a topic that has captivated many segments of society, with priests, philosophers, educators, media professionals, and others participating. Many ethical difficulties presented in scientific study were covered by the media, for example. On the technical side, there are nuclear tests and chemical and biological weapons experiments, while on the humanitarian side, there are secret Cold War experimentation on humans, animal cloning experiments, genetic engineering, and map control. IVF, surrogacy, and so-called euthanasia are all examples of genetics, And many other controversial scientific innovations. There are also a number of unethical cases in the fields of academic scientific research that have been recorded by some scholars and government officials in some countries. Examples include: Scientific thefts, deception, failure to acknowledge the efforts of others, tampering with some research results, and giving priority to the private interest over the public interest. There is another factor that imposes itself and makes interest in the ethics of science urgent, which is the mutual relationship between scientists and commercial and industrial companies, as this relationship produces a conflict between scientific ethical values on the one hand, and the values of trade and market and the principle of profit and loss on the other hand, which may lead to abandonment The scientist expresses his ethical principles for the benefit of the company or commercial entity that funds his research in order to obtain personal economic gains.

**OBJECTIVE OF THE STUDY**

What is the extent to which the Science Ethics Are Included In The Science Book For The First grade in Middle School

**LIMITS OF RESEARCH**

Defining the Science Ethics Are Included In The Science Book For The First Grade In Middle School for the academic year (2021-2022).

**TERMS & DEFINITIONS**

**SCIENCE ETHICS:** It is a set of scientific and ethical rules and provisions that direct a person's behavior for the better in the direction of ethical issues and problems raised by scientific and technological applications in various fields, and thus determine the proper framework for directing scientific innovations for the benefit of humanity

**SCIENCE BOOK:** It is the second version, which was finished in 2017 by a group of specialists from the Ministry of Education, with the help of a UNESCO committee.

**FIRST MIDDLE SCHOOL:** It is the first stage of the middle school stage, It comes after primary school, a span of time that begins when you are twelve years old and concludes when you are fifteen years old.

**METHODOLOGY-IN-BRIEF**

The study used a descriptive-analytical method, which is defined as "a scientific diagnosis of a phenomenon and a quantitative insight into it using language and mathematical symbols."

(Anwar and Adnan, 2007: 191)

### RESEARCH SAMPLE

The scientific book for the middle stage in Iraq for the academic year 2021/2022, which is a statistical community, was part of the research community, as stated in Table (1)

TABLE 1: RESEARCH SAMPLE

No	Name of the book	Stage	Edition	Publication	Page No
1	science book for the middle stage in Iraq	First Grade In Middle School	second	2017	144

### THE RESEARCHER EXCLUDED:

- Introduction in each chapter the book.
- Questions at the end of each chapter.
- Content list.

This procedure is among the rules of analysis, because these aspects do not represent scientific content that is directly related to the purpose of the research, or because of the difficulty of dividing some of them into specific and clear thought, in addition to being a familiar procedure in content analysis studies.

The number of pages of the book subject to analysis was 125, mean 86.8% of the total number of pages.

### RESEARCH TOOL

Experts in research methods confirmed that content analysis requires the existence of a classification system that fits with the research problem, and Kerlinger considers it (Kerlinger, 1973) the most important step in content analysis because it is a direct reflection of the problem to be studied.

(Samara& others, 1989:150)

### THE PURPOSE OF THE SEARCH TOOL

The tool aims to determine the standards of ethics in science and its indicators that should be included in the science book for the first intermediate grade, and they include the following

- 1- Academic issues
- 2- Humanitarian issues
- 3- Application issues
- 4- Objectivity
- 5- The role of scholars

### FACE VALIDITY

It signifies that the scale measures what was intended to be measured or accomplishes the goal for which it was designed, the researcher was able to check the validity of the scale by relying on the correctness of the opinions of a group of experts and professionals, the scale was found to be legitimate for the objectives for which it was created.

(Ebel, 1972:554)

The researcher gave a group of experts in educational psychology, instructional methods, sciences, curricula, measurement, and assessment the scientific ethics scale and requested them to comment on the validity of the scale's components. It received a minimum approval rate of 85.58 percent, and the classification of scientific ethics norms was defined in its final form, as shown in Table (2)

Table 2: Percentage of experts' agreement on the research tool

No	Standards	Percentage Of Experts Agreement
1.	Academic Issues	83,55%
2.	Humanitarian Issues	81,27%
3.	The Role Of Scientists	87,36%
4.	Objectivity	90,13%
5.	Application Issues	93,21%
<b>Total</b>		<b>342.31 %</b>
<b>Average</b>		<b>85.58 %</b>

## PROCEDURES FOR ANALYSIS

### 1. The Unit of Analysis

The content was separated into categories or units by the researcher so that each unit could be studied separately by computing its own frequency. The nature of the analyzed material and the nature of the problem under investigation determine the unit of analysis, In order to analyses the content, the researcher used the following two units:

#### A. Unit for Recording

The smallest part of the analyzed material through which to count what has to be diagnosed in that content is the unit of record. Berelson and Budd state that there are five basic units of analysis: the word or symbol, the idea or phrase that carries the idea, the subject unit, the personality, and the distance and time measures (Berelson, 1959:509). The researcher chose the idea unit, which is one of the most important and largest units of content analysis and is divided into two types: the explicit idea and the implicit idea.

#### B. Unit of Context

In this unit, the researcher recorded units using counting and measuring methods based on explicit and implicit notions after carefully analyzing them to determine the substance of the scientific expression and encoding it in the correct dimension.

### 2. Enumeration Unit

The researcher employed the Frequency technique as a unit to enumerate the emergence of thinking in each of the classification's paragraphs and fields, which is the most extensively used method in content analysis.

## ANALYTICAL VALIDITY

To confirm the validity of the analysis, the researcher offered the method of analysis to specialists with a model for it, as well as instructions on how to extract the idea and categories it within its areas using markers of scientific ethical norms, The researcher's appendix (1) was approved by the majority of specialists, resulting in a percentage of agreement of 0.80, which is an excellent proportion, Table (3) depicts an analysis model for the first intermediate grade in the topic of chemistry and industry.

Table 3: Model for analysis

No	Idea	Standard
1-	Using the sciences of chemistry and chemical reactions to produce new chemicals	2
2-	Changing raw materials obtained from mines and agriculture into other useful materials in our daily life	3
3-	Treating cancerous tumors by radioactive cobalt	5

## ANALYZE RELIABLE

Because the Reliable is one of the most essential aspects that must be examined in content analysis studies, it refers to the compatibility of the results of content analysis for a number of professionals using one measurement tool.

(Kidd and Wadsworth, 1989: 197)

The analysis was used by the researcher through time and comparison analysis with a researcher taught by the researcher and a specialized researcher in order for the analysis to be objective and restrict the subjectivity of the single analyst, The researcher used (**Holstey**) equation to calculate the reliability coefficient or the agreement coefficient between the analysts. The three, as shown in Table (4).

Table 4: Reliable of analysis for analysts

No	Analysis	Reliable of analysis
1-	The researcher is with himself after 30 days have passed	91.97%
2-	Researcher and the first Analyst	80.95%
3-	Researcher and the second Analyst	83.90%
4-	Average	85.61%

Three weeks had passed between the researcher's analysis of himself throughout time, and the (**Holstey**) equation was used to determine the tool's stability, as shown in the statistical techniques, he researcher with himself, the researcher with the trainee researcher, and the researcher with the specialist.

The Reliable coefficients obtained by the researcher are within the range and at a high level sufficient to ensure confidence in the stability of the analysis. And more, it indicates that the level of stability is high.

(Ober & other, 1971: 85)

### STATISTICAL TREATMENTS:

1. **Holstey's equation:** to find the stability of the book analysis between the researcher and himself and other analysts.

$$R = \frac{2(C1, 2)}{C1 + C2}$$

### 2. PERCENTAGE:

$$\text{percentage} = \frac{\text{parts}}{\text{total partes}} \times 100\%$$

)Zangana and Adnan, 2008: 237(

### SHOW THE RESULTS:

#### The Main Standards Of Ethics In Science:

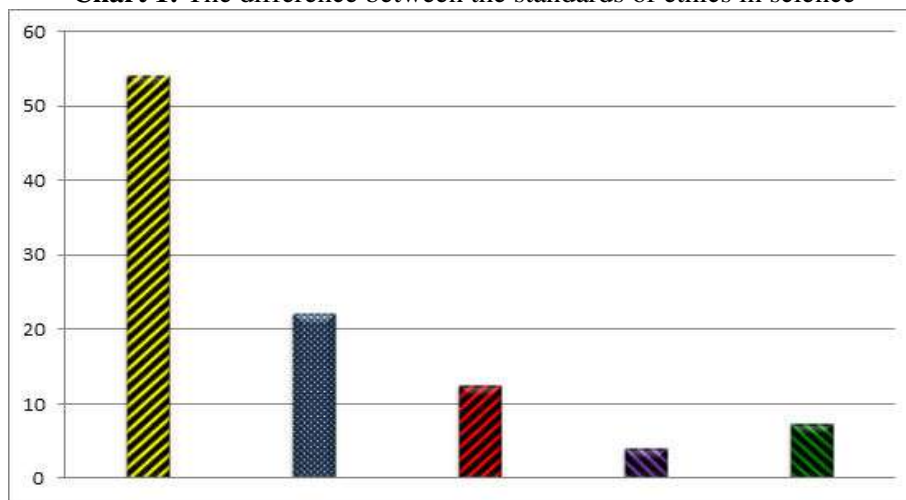
The researcher extracted (626) ideas were extracted from the content of the science book for the first intermediate grade of science approved for the academic year 2021-2022, and they were distributed among the five main standards of science ethics, as shown in the following table (6):

**Table 6:** Frequencies and percentage of standards of ethics in science in the science book for the first intermediate grade

No	Standards	Frequencies	percentage
1.	Academic Issues	339	54.15%
2.	Humanitarian Issues	138	22.04%
3.	The Role Of Scientists	78	12.46%
4.	Objectivity	25	3.99%
5.	Application Issues	46	7.34%
<b>Total</b>		<b>626</b>	<b>100%</b>

Table (5) shows that the book got (626) sequelae spread across five Standards, and the Standards of (academic issues), (humanitarian issues) and (practical issues) got the highest percentage, which is (54.15%), (22.02%), (12.46%) respectively, and the (objectivity), (the role of scholars) had the lowest percentage, which is (2.64%), (3.9%), (7.15%), respectively. The book did not neglect any dimension of the dimensions, and the Chart (1) Explain the differences between the dimensions.

**Chart 1:** The difference between the standards of ethics in science



We conclude from the above results that the content of the science book for the first intermediate grade gave great importance to the standards of (academic issues), (humanity issues) (applied issues) more than (objectivity) and (the role of scientists).



## CONCLUSIONS

1. The science book for the first middle grade focused in the first degree on academic issues, humanitarian issues, and applied issues and did not give more attention to other standards.
2. Emphasis on including all standards of ethics in science in the science book for the first middle grade and equally.

## RECOMMENDATIONS

Based on the findings of the study, the researcher suggests the following:

1. Rethinking the content of the first middle school science book by adding science ethics in it, emphasizing the incorporation of new trends in curricula, and emphasizing the relevance of students' understanding of this interaction for their lives on the one hand and their society on the other.
2. Developing a science book for the first intermediate grade that adheres to scientific ethics.

## SUGGESTIONS

Conducting a similar study to analyze books of other scientific subjects and for different academic levels.

## REFERNCES

1. Al-Hudhaifi, Khaled bin Fahd, (2010). The degree to which the content of science textbooks for primary classes in the Sultanate of Oman conforms to the American national standards, Sultan Qaboos University.
2. Atef, Abdel Aziz Abdel Maqsood, (1995). "An evaluation study of the agricultural sciences teacher preparation program at the Faculty of Education in the light of scientific enlightenment", published Master's thesis, Faculty of Education, Menoufia University.
3. Ebel, Robert, (1972). "Essential of Educational Measurement", (12), 2nd, prentice – Hall, New Jersey
4. Kidd, L.L. and Wadsworth, A .J . (1989), "Content Analysis Measurement of Communication Behavior", Eds Philip Emmett and Larry Barker, Longman, New York.
5. Mohamed Saber Selim, (1989). "Scientific enlightenment is a fact that imposes itself on curriculum experts. Journal of Studies in Curricula and Teaching Methods", No. (5), January, The Egyptian Association for Curricula and Teaching Methods, p. 2.
6. Ober, Richard & Other (1971), "Systematic Observational of Teaching prentice", – Hall, Icn , new jersey.
7. Rabie, Hadi Mishaan, (2006). "Modern Trends in Teaching Science", 2nd Edition, Dar Al Masirah for Publishing, Printing and Distribution, Amman
8. Samara, Aziz and others, (1989). "Principles of Measurement and Evaluation in Education", 2nd Edition, Dar Al-Fikr, Amman
9. Zangana, Adnan Haqqi Shihab, and Abd al-Rahman Anwar Hussein, (2008), "Perceptonal and Theoretical Foundations in the Curricula of Humanities and Applied Sciences", 1st Edition, College of Education Ibn Al-Haytham - University of Baghdad.

## APPENDIX:

### Appendix1: Ethics of Scientists

Main Standards		Aspects	
1.	Academic Issues	–	Mutual cooperation between scientists in scientific fields. – Scientific secretariat.
2.	Humanitarian Issues	–	Explanation of the psychological effects of some scientific activities on humans. – Explain the dangers of scientific experiments conducted on humans. – Understand the concept of science ethics. – Included to mention the scientific innovations that raise controversy from an ethical point of view.

---

---

<b>3.</b>	<b>The Role of Scientists</b>	<ul style="list-style-type: none"><li>- Chemical and atomic weapons.<ul style="list-style-type: none"><li>- Nuclear reactors.</li></ul></li><li>- Mechanism for the disposal of toxic nuclear and chemical waste.</li><li>- Chemical pesticide spraying devices.<ul style="list-style-type: none"><li>- Drugs and drugs.</li></ul></li><li>- Mechanism of genetic modification with chemicals</li></ul>
<b>4.</b>	<b>Objectivity</b>	<ul style="list-style-type: none"><li>- Determine the benefit of criticism.<ul style="list-style-type: none"><li>- Accept directions and advice</li></ul></li><li>- Paying attention to criticism from others and not neglecting it</li><li>- Adjusting positions in light of criticism</li></ul>

## A Study on Job Satisfaction amongst Anganwadi Workers in Mumbai Region

Reshma Rajaram More and Varsha S. Mallah

Commerce Department, Bhavans Hazarimal Somani College, Chowpatty, Mumbai, Maharashtra, India

### ABSTRACT

ICDS is one of the flagship programmes of the Government of India and represents one of the world's largest programmes for childhood care and development. Anganwadi workers play the role of bridge between the community and the ICDS department with the object to fight against reducing infant mortality and child malnutrition. Job satisfaction is a feeling of contentedness towards one's job. It is a very important aspect in the life of every working person. The personnel who work under the Integrated Child Development Service Scheme (ICDS) are no exception to this. The present study provides an overview of Anganwadi Centres in Mumbai region and also job satisfaction amongst the Anganwadi workers. **Anganwadi Worker (AWW) and Anganwadi helpers** both are the main pillars of this program. They play an active role in bringing the services to the doorstep of the beneficiaries even with lack of infrastructure, shortage of place and part-time honorary. Anganwadi centres are meant for providing benefits to the society but to make this scheme more effective and result oriented due care should be given to the staff employed for the same.

Keywords: ICDS, Anganwadi Workers (Teacher and Helpers) and Job Satisfaction.

### 1. INTRODUCTION

*"It doesn't matter whether you do small or big Job; what matters is job Contentment."*

#### MOHITH AGADI

Job satisfaction is a feeling of contentedness towards one's job. It is a very important aspect in the life of every working person. It affects positively the professional, personal and social life of an individual. Absence of job satisfaction amongst employees will lead to lower productivity, high absenteeism and high employee turnover in the organisation. It is therefore essential to identify the factors responsible for influencing job satisfaction amongst workforces. The personnel who work under the Integrated Child Development Service Scheme (ICDS) are no exception to this.

ICDS is one of the flagship programmes of the Government of India and represents one of the world's largest programmes for childhood care and development. It was launched on October 2, 1975. It provides a package of six services such as., supplementary nutrition, immunization, health checkups, referral services, nutrition and health education for a child, pregnant women, nursing mothers and also to adolescent girls. Anganwadi workers play the role of bridge between the community and the ICDS department with the object to fight against reducing infant mortality and child malnutrition. As their main task, Anganwadi workers lead the country's war against under nutrition. They play an active role in bringing the services to the doorstep of the beneficiaries even with lack of infrastructure, shortage of place and part-time honorary. Even during the Covid-19 pandemic and the subsequent lockdown across the country, these social educators were assigned additional task of moving door to door and creating public awareness about the pandemic, they were also involved in collecting data from households. To ensure the effective implementation of ICDS programme it is imperative that the Anganwadi workers feel contented with their work. The present paper is, therefore, an attempt to understand the level of job satisfaction amongst Anganwadi workers.

### 2. REVIEW OF LITERATURE

- Sandhyarani M. et al., (2013)<sup>1</sup>., in their paper, have focused on the role and responsibilities of Anganwadi workers in the Mysore district. They stated that the Anganwadi workers are very active in serving their services to the beneficiary groups of the society. They not only reach a variety of beneficiary groups but also provide them with different services under one roof with part-time honorary, which is very minimal compared to their service in the society. They also reveal, to provide proper service to a beneficiary in future, the Department of Women and Child Welfare has to consider the right remuneration for Anganwadi Workers.
- Desai G. et al., (2012)<sup>2</sup>., in their paper, reveal that the Anganwadi Worker and helper, are the basic functionaries of the ICDS. Their role is not limited; the AWWs are overworked and are not able to justify their routine work. Despite low remuneration, their activities are very extensive. They are also involved in other National Health Programmes such as pulse polio etc. Therefore, the paper suggests that the government health authorities should cater to the Anganwadi workers as per their need.

- Borgoha H. et al., (2017)<sup>3</sup>, in their paper, evaluated the job satisfaction of Anganwadi Workers in the Sivasagar district of Assam. They stated that being as Anganwadi workers, working with the children in public service earns respectability from society, which produces a high level of job satisfaction compared to those who work in other departments. But as compared to their work honorarium, and workload, Anganwadi workers and helpers are not satisfied with the component of salary and over workload.

### 3. OBJECTIVE OF THE STUDY

The objectives of the study are stated as follows:

1. To take an overview of Anganwadi Centres in Mumbai region.
2. To examine the level of job satisfaction amongst the Anganwadi workers in Mumbai region

### 4. RESEARCH METHODOLOGY OF THE STUDY

To execute the present study the information has been collected through primary and secondary sources. Primary data are collected with the help of a structured questionnaire in the regional language (Marathi). It was distributed through Google Form link amongst Anganwadi Teachers and Helpers. With the help of Convenient Random Sample Technique 25 Anganwadi centres in Mumbai were selected. The Anganwadi Teachers and Helpers who are working in these Anganwadi centres were considered as samples of the study. Thus, the total sample size of the study is 50, comprising of 25 Anganwadi Workers (Sevika) and 25 Anganwadi Helpers (Madatnis). The secondary data has been gathered from sources such as the Official website of ICDS Maharashtra, reference books, Newspapers, Journals etc. To facilitate interpretation collected data was compiled and tabulated. Statistical tools such as percentages and Averages are applied with the help of statistical package software.

### 5. FINDING AND ANALYSIS

The Integrated Child Development Services (ICDS) Scheme is one of the world's largest and unique programmes for childhood care and development running under the Government of India. It is to provide these complimentary services in an integrated manner with the object to reduce infant mortality and child malnutrition. In this programme, many of them take the initial part to carry such responsibilities on their shoulders such as Anganwadi Workers, Anganwadi Helpers, CDPO, Supervisor, Auxiliary Nurse Midwife (ANM), Accredited Social Health Activist (ASHA), NGOs etc.

Anganwadis are the prime units of the Integrated Child Development Services to be focused on child and mother care and development. It includes many activities such as delivering high-quality healthcare, nutrition to children, pregnant women, and nursing mothers, teaching mothers about child nutrition, community education, giving pre-formal school education, immunisation, as well as counselling to the teenage girls under Kishori Shakti Yojana (KSY). Normally, An Anganwadi centre covers a population of 1000 people in rural as well as urban areas and 700 people in tribal areas. Anganwadi Worker (AWW) and Anganwadi helpers both are the main pillars of this program and play an active role in bringing the services to the doorstep of the beneficiaries. The primary services performed by them are-

- The Anganwadi workers are responsible for taking care of the children between the age group of 3yrs to 5yrs. They provide freshly prepared nutritious food for the children at Anganwadi Centre.
- They provide nutritious food for pregnant mothers on regular basis. Once in a month they go for pregnant mother's survey to curb maternal mortality. They not only give nutritious food to pregnant mothers but also take them to the government hospitals for a regular check-up to keep the infant in the womb healthy. After the delivery, they also guide mothers about the scheme of Bhagyalakshmi programme, where a bond of ten thousand rupees is deposited for a girl child. But the benefits of the scheme are restricted to two girl children from below poverty line families only.
- Under Kishori Shakti Yojana (KSY) Anganwadi Workers provide training, counselling, conducting discussions on the maintenance of personal hygiene, intake of nutritious food, adolescent puberty problems, etc. to teenage girls (kishoris) who belongs to poor family background and is within the age limit of 11yrs to 18 yrs.
- Apart from the above activities, they are also involved in other National Health Programmes such as setting up a pulse polio programme in their respective Anganwadi centre. They do door to door survey of the children belonging to the age group of below five years to bring under vaccination programme.

### 5.1 Overview of Anganwadi Centres in Mumbai Region

Maharashtra is the second largest state in the country where 1,08,005 Anganwadi/Mini Anganwadi Centres are operated by around 2 Lakhs Anganwadi Workers and Anganwadi Helpers with 4,000 Supervisors. Mumbai is the biggest metropolis of Maharashtra state and also one of the most densely populated cities in the world. According to census 2011, out of the total population of Mumbai, 42 per cent of the population lives in slums. Around 5,130 Anganwadi centres are running in these slum areas under Integrated Child Development Services programme.

**Table-1** Number of Anganwadi Centres in Mumbai (As of March 2019)

Sr. No.	Region	No. of Anganwadi	Sr. No.	Region	No. of Anganwadi
1	Andheri-1	144	18	Khar (West) Santacruz (East)	220
2	Andheri-2	145	19	Khar , Santacruz	102
3	Andheri-3	155	20	Kurla (U)	169
4	Bhandup (East)	135	21	Mahim	150
5	Bhandup (West)	165	22	Malvani	115
6	Bandra (West)	175	23	Mankhurd (U)	162
7	Borivali-1	121	24	Mulund (East)	100
8	Borivali-2	185	25	Mulund (West)	150
9	Chembur	150	26	Prabhadevi	147
10	Colaba	100	27	Red Light Area	109
11	Dharavi (U)	300	28	Shivajinager	135
12	Ghatkopar (U)	154	29	Trombe	115
13	Ghatkopar -2	103	30	Tungamohali	175
14	Goregaon (East)	193	31	Vikholi	146
15	Goregaon (West)	159	32	Wadala/Shivadi	269
16	Gowandi (U)	150	33	Worli (U)	190
17	Jogeshwari	142			
<b>Total 5,130</b>					

**Source:** Report on State of Health of Children in Anganwadis and Municipal Schools in Mumbai November 2019.

Table-1 shows the distribution of 5,130 Anganwadi Centres running in 33 different areas of Mumbai under Integrated Child Development Services, as of 31<sup>st</sup> March 2019. Dharavi is the largest slum area of Mumbai where maximum i.e. 300 Anganwadi Centres are running, which is the highest in Mumbai. Similarly, Colaba has the least that is 100 Anganwadi Centres.

The Anganwadi Services envisages the Anganwadi Workers (Anganwadi Sevika) and Helpers (Anganwadi Madatnis) as honorary workers from local community who come forward to render their services, on part time basis, in the area of child care and development. Being honorary workers, they are paid monthly honoraria as decided by Government from time to time.

**Table-2** Number of Functionary of Integrated Child Development Services in Mumbai (As on March 2019)

Position	No. of post Sanctioned	No. of post Functioning	Shortage /Differences
Anganwadi Worker	5,130	4,977	153 (3%)
Anganwadi Helper	5,130	4,316	814 (16%)
Supervisor	206	129	77 (38%)
Child Development Project Officer (CDPO)	33	20	13 (40%)

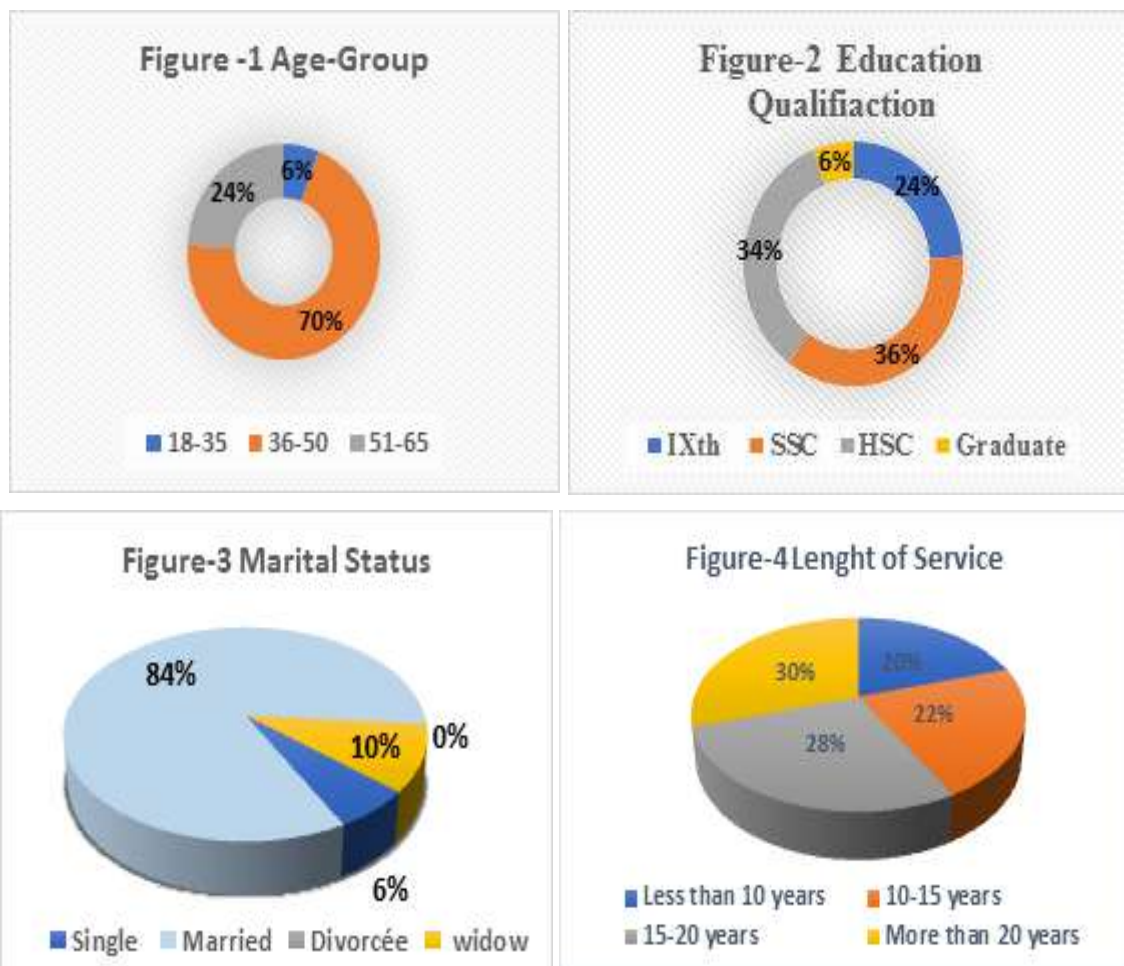
**Source:** Report on State of Health of Children in Anganwadis and Municipal Schools in Mumbai November 2019.

Table-2 exhibits number of functionary of Integrated Child Development Services in Mumbai as of 31<sup>st</sup> March 2019. The total sanctioned post of Anganwadi workers was 5,130 out of which only 4,977 workers are appointed. Similarly, the sanctioned post for Anganwadi helpers is 5,130 but only 4,316 positions are filled. The Supervisors, who guide Anganwadi workers & helpers, their total sanctioned post is 209 out of which only 129 supervisors are appointed. Whereas, for CDPO out of the 33 total post sanctioned only 20 CDPO positions are

filled and they are controlling 5130 Anganwadi Centres of Mumbai. It can be seen from Table-2 that there is shortage of functionary in ICDS programme, which results in overload for the existing functionaries which further results into dissatisfaction and compromises in the quality of service.

### 5.2 Level of job satisfaction amongst the Anganwadi workers in Mumbai region

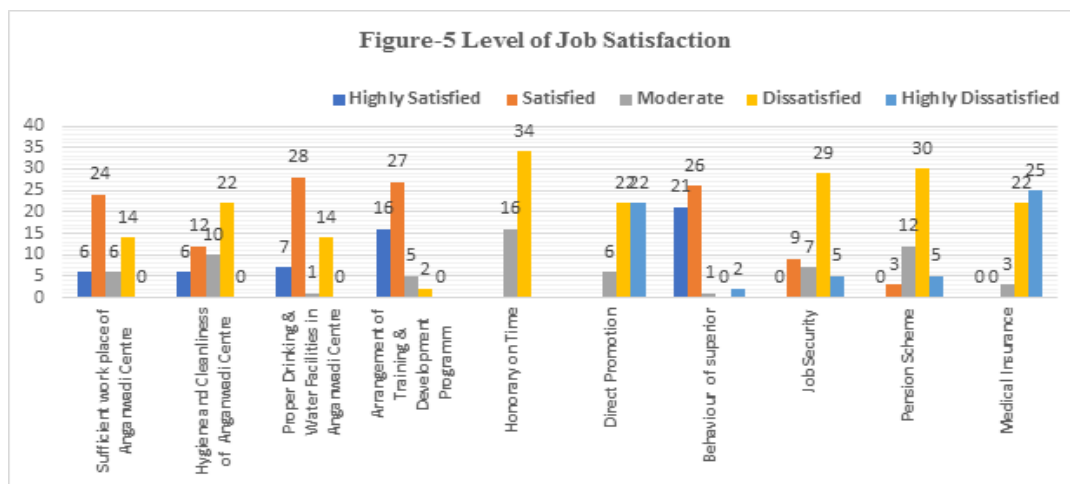
Job satisfaction amongst employees of any organisation is important to achieve organisational objectives. In order to ascertain the level of job satisfaction amongst ICDS workers a primary survey was conducted in 25 Anganwadi centres. Simple random and convenient sampling method was used to select these Anganwadi centres. The data was collected from 25 Anganwadi Workers (Sevika) and 25 Anganwadi Helpers (Madatnis) working in above centres. The demographic profile of respondents is presented as below-



Source: Self Complied

Figure-1 shows that maximum respondents i.e. 70 percent fall between the age group 36 to 50 years. Figure-2, depicts the education qualification of respondents; out of the total respondent 24 percent are IX passed, 34 percent respondents are SSC and 36. Percent respondents are HSC passed and only 6 percent are graduates. Figure-3 displays the marital status of respondents. It shows that 84 percent of respondents are married, 10 percent are divorced and 6 percent are single. The survey also collected information with respect to the length of service of AWW; Figure-4 shows that 30 percent of respondents have more than 20 years of experience working as Anganwadi workers.

The present study in order to determine job satisfaction amongst the Anganwadi workers conducted a primary survey. The study included questions related to various parameters related to working conditions and job satisfaction of Anganwadi workers and the respondents were asked to rate their level of satisfaction as per the scale given. The responses for the same is compiled and exhibited below in Figure-5.



Source: Self Complied.

- With regards to place provided for Anganwadi centre, Figure-5 shows that out of the 50 respondents 24 are satisfied, whereas 14 respondents are found to be dissatisfied with the place allocated for Anganwadi Centre. It is observed that at most of the places there is no separate place for Anganwadi Centre, normally AWW function their centres either in public place or a residential house in a slum area on monthly rental basis. It was also noted that there is not enough space to store supplementary nutrition food, Register notebook, teaching materials, weight loss machine etc.
- Regarding hygiene and cleanliness facilities in Anganwadi Centre, 12 respondents are satisfied with the facilities, 6 are highly satisfied and 10 respondents are moderately satisfied. However, 22 respondents are dissatisfied with these facilities. This is due to the absence of a separate place for storage. It was also found that the supplies gets damaged and spoiled and due to lack of appropriate provisions for safety and it becomes difficult to protect the stock from insects, rats, cockroaches etc.
- The study further marked that 28 respondents are satisfied with the availability of drinking & water facilities in Anganwadi Centre and 7 respondents are highly satisfied with this facility. However, 14 respondents are not satisfied with the availability of drinking & water facilities as they are getting these facilities from the local municipality public water tab.
- Regular training programmes are a must for job satisfaction and high morale as they keep employees updated with their work. In Anganwadi service, training is imparted to the functionaries on a regular basis. It includes various programmes on role and responsibilities of Anganwadi workers, pre-primary education, psychosocial development program of children below the age of 3 years, food & nutrition balance diet programme, personal hygiene care for Kishori girls, pregnant women and feeding women etc. The respondents' response towards Training & Development Programmes organised by ICDS shows that 16 AWW are highly satisfied and 27 are satisfied with such programmes. (Some write-up)
- Job remuneration is the prime factor for which people work. The study, therefore, further enquired about the honorarium paid by the authority to the Anganwadi workers. It was found that 34 respondents are dissatisfied regarding their honorarium and 10 respondents are moderately satisfied. It was found that the Anganwadi sevika receives an honorarium around Rs. 8,000/- per month and helpers receive around Rs. 4,250. It was found that AWWs find their honorarium very low as compared to the responsibilities and duties handled by them. It was further noted that the payment is delayed most of the times which also negatively affects the workers.
- Every employee expects progression in job. Promotion therefore is an important indicator of job satisfaction. The study found that 22 respondents are dissatisfied and 22 are highly dissatisfied with the procedure of job promotions at Anganwadi centres. It was observed that there is no direct promotion process based on experience or result oriented performance. Promotions for AWW depend on written tests and interviews.
- Work satisfaction also depends upon the behaviour of superiors. In the context of Anganwadi Centre CDPO and Supervisor are the superiors who are involved with Anganwadi workers for different activities. Out of 50 respondents, 26 respondents are satisfied and 22 are highly satisfied with the Behaviour of their superiors.

- Job security is another important parameter that keeps an employee satisfied. The present study shows that 30 respondents are dissatisfied with their job status that lacks security. They are working under the ICDS scheme on a part-time basis with basic honorarium.
- Pension, another parameter of job satisfaction, is a monetary benefit, other than wages, paid at regular intervals to a person or to the person's surviving dependents in consideration of past services. There is a provision of retirement benefits to Anganwadi Workers and Helpers. They are paid approx. Rs. 1,00,000 after their retirement. It was found in the present study that 30 Anganwadi workers are not satisfied with the pension Scheme provided by the ICDS.
- The present study further enquired about job satisfaction with respect to the medical facilities provided by the authorities. It was found that 22 AWW are dissatisfied and 25 AWWs are highly dissatisfied with medical facilities provided by ICDS for them. Anganwadi workers and helpers are actively involved in bringing the public health services to the doorstep of the beneficiaries but for their own health and workplace safety no such provisions are available.

## 6. CONCLUSION

Anganwadi Services Scheme of ICDS has come up with differential approaches across the States. The present study provides an overview of Anganwadi Centres in Mumbai region and also job satisfaction amongst the Anganwadi workers. It was found that more than 80 per cent of Anganwadi centres are running in a tiny room of the Mumbai Slums area. Sometimes, there is no space for children to sit also; therefore separate and adequate space is required for Anganwadi centres. The basic facilities like drinking water, cleanliness and hygiene, storage facility etc. are must for the overall efficiency of anganwadi centres. Anganwadi workers are overloaded due to inadequate manpower therefore there is a need to fulfil the vacant posts. AWWs are expected to provide consistent services to the beneficiary groups and in return their bare minimum expectation is modest and timely honorarium by the concerned authority. There are areas of concern such as job progression, job security, pension etc. that are essential to ensure job satisfaction amongst AWWs. However, amidst all these factors there are parameters like regular training for skill and knowledge updating that are well placed. The senior officials are found to be supportive that encourages AWWs to keep performing. It can be concluded that Anganwadi centres are meant for providing benefits to the society but to make this scheme more effective and result oriented due care should be given to the staff employed for the same.

## REFERENCES

- Sandhyarani M. et al., (2013). "Role and Responsibilities of Anganwadi Workers with special reference to Mysore District". *International Journal of Science, Environment*. ISSN 2278-3687, Vol. 2, No 6. pp. 1277 – 1296.
- Desai G. et al., (2012). "Changing role of Anganwadi workers, A study conducted in Vadodara district". *Health line*, ISSN 2229-337X Vol. 3 Issue 1 - January-June 2012. pp. 41-44.
- Borgoha H. et al., (2017). "Job Satisfaction of Anganwadi Workers: A Study in Sivasagar District of Assam". *International Journal of Innovative Research in Science, Engineering and Technology (A High Impact Factor & UGC Approved Journal)*. Website: [www.ijirset.com](http://www.ijirset.com) Vol. 6, Issue 9, September 2017. ISSN (Online): 2319-8753 ISSN (Print): 2347-6710. pp. 19372 – 19381.
- S. Vijayavardhini et al., (2017). "Job Satisfaction of Anganwadi Teacher's: A Study". *The International Journal of Indian Psychology*, ISSN 2348-5396 (e) ISSN: 2349-3429 (p) pp 138-146.
- Thakare M. et al., (2011). "Knowledge of Anganwadi of Anganwadi Workers and their problems in an urban ICDS block". *Journal of Medical College Chandigarh*, 2011, Vol. 1, No.1. pp. 15-19.
- Training Division National Institute of Public Cooperation and Child Development (2018). *Best Practices in Anganwadi services scheme under umbrella ICDS*. New Delhi.

## WEB SOURCES

- <https://womenchild.maharashtra.gov.in>
- <https://icds.gov.in>
- <http://www.-icds-wcd.nic.in>



## **Agri-Business: A Ray of Hope to Indian Economy Amid Covid-19 Crises**

**Kalpana Rawat, Raj Kiran Prabhakar and Jatoth Sai Kiran**

Institute of Management Studies, Banaras Hindu University, Varanasi, Uttar Pradesh, India

### **ABSTRACT**

World Health Organization informed pneumonia cases of unknown cause in Wuhan City, China on December 31<sup>st</sup> 2019. A novel coronavirus identified by Chinese authorities on January 7, 2020 and named it as covid-19. A novel coronavirus (nCov) characterized by illness ranging from common cold to more severe disease. WHO issued recommendations for general public to avoid contact with anyone and maintain social distance. In India, first case of covid-19 infection reported in Kerala. Government of India decided to impose a nationwide lockdown on March 24, 2020 to contain virus. Coronavirus induced lockdown led to shutdown of world economies including agriculture, manufacturing and service sector. Lockdown led to imposition on displacement of migrants, job losses as well as hitting world trade at rock bottom level. Consequently Indian economy also severely hit by global pandemic. Indian economy contracted by 7.3 percent in April-June 2020 quarter. India's 2.9 trillion dollar economy remain shuttered except some essential services and activities. All major sectors of economy badly hit except agriculture. Agricultural business initially trembled but over a period of time it came back on track. Even it shows a higher growth rate than previous financial year. Proposed paper will examine responsible factors for growth of agriculture sector in Indian economy during covid-19 induced crises. How agriculture sector became a savior for human lives as well as for economy of India whereas others shaken?

Keywords: Covid-19, Agri-business, Supply Chain, AEPDA

### **INTRODUCTION**

Agriculture is primary source of livelihood accounted for approximately 58 percent of India's population. Estimation of Gross Value Added by Agriculture, forestry and fishing stood at US \$ 276.37 billion in financial year 2020 (PIB 2020). India has immense huge potential for value addition, particularly within food processing industry. Indian food processing industry is a source of 32 percent of country's total food market. Indian food and grocery market is world's sixth largest and fifth largest in context of production, consumption, export and expected growth. Indian agri-export in global agri market accounts over 2.5 percent. Major export destinations of Indian agro-produce are U.S.A., Saudi-Arabia, Iran, Nepal, Bangladesh. Agriculture dominant Indian economy dynamically making efforts to become a leader in particular sector but it got a major stoke when world economies trapped into disastrous cycle of global pandemic of covid-19. India not left untouched from curses of pandemic crises (FOUNDATION, 2021).

Origination of pandemic traced from December 31 2019 when Chinese authorities informed cases of pneumonia detected in Wuhan city in Hubei province of China. WHO continuously in contact with network of researchers and experts to coordinate global work on modeling, diagnostic, clinical care and treatment to cure the disease. WHO has issued guidance for countries to take precautions to contained the disease (World Health Organization, January 2020). WHO guidelines for containment of disease includes keep physical distance of at least one meter, avoid crowds and close contact, wear mask properly, clean hand frequently. As a result economic activities globally started to shutdown in order to maintain social distance (WHO, February 2020). On June 2020 Global Economic Prospect reported a baseline forecast envision a 5.2 percent contraction in global GDP. Per capita income contracted in largest fraction of countries globally since 1870. Advanced economies projected to shrink by 7 percent and emerging market and developing economies contracted by 2.7 percent (Global Economic Outlook: World Bank, June 2020).

Textiles, clothing, leather and footwear industries started to crippling as workers started stay at home, factories shutdown and global supply chain halted. Teachers have to adopt universal distance education as nearly 94 percent learners faced school closure. Small and medium enterprises have hardest hit and millions of job at risk. Automotive industry hit by triple whammy: factory closure, supply chain disruption and collapsed demand. Agri workers facing hurdles in procurement of agri-inputs as well as difficulties to transport agro produce from farm gate to market. Food retail workers at high risk of exposure while food and related stuff declared under essential commodities guaranteed food security (ILO).

In India, government declared stringent lockdown on March 24, 2020 which further extended as per updated guidelines of WHO. Coronavirus pandemic proved to be fatal in terms of human lives and economic

activities in India also. Manufacturing industry reached a sudden stop. Factory workers quite to come at work with resulting impact on quality, cost and volume. Top software companies like Tata Consultancy Services, Infosys and HCL reduced technological spending as felt drop in spending from U.S. and Europe. HDFC securities predicted 2-7 percent reduction in IT revenue. India's development in final quarter of fiscal year 2020 declined to 3.1 percent as per Ministry of Statistics (Sidhu et al. 2020).

Worst happened in agriculture sector also, when lockdown imposed and severe trust deficit occurred. In India, agricultural workers and farmers engage in agriculture activities seasonally. Based on seasons, Indian crops divided into three types – (a)- Rabi (harvested in March- April), (b)- Kharif (Sep-Oct), (c)- Zaid (early maturing crops, grown and harvested between March-June). Rest of the period they used to migrate in cities to earn daily wages for their livelihood. Global pandemic struck agriculture sector when Rabi crops about to harvest (March-April). Wheat is the main rabi crop. India is second largest producer of wheat in the world. Uttar-Pradesh account for more than one third of crop production (35%), followed by Punjab (21.5%) and Haryana (13.2%). These states largely depend on labour force for harvesting crop and weighing the produce. But pandemic induced lockdown prohibit displacement of labors to their villages from cities where they work on daily basis.

Farmers had no experience to handle such a pandemic situation. They suffered from problem of suspension of transportation, shortage of supply of farming machinery and equipments including harvester and gunny bags (used to store wheat produce) supply from West-Bengal. Under transportation inter-state movement banned so agriculture supply chain distorted. Procurement centers of agriculture inputs partially opened or closed. Consequently blockages entered in working of mandis. A fragmented demand arose as public started to store extra grain in panic. Aggregate demand and supply of agro-produces shrank causing crippling effect on employment and income. This demand and supply disruptions led to a fall in prices of commodities. Upward trend in retail prices associated with increased transaction cost for retailers. On a large scale prices risen at end consumer side. Farmers saw a steep decline in fragmented prices. (Radyot Ranjan Jena n.d.)

Government of India relaxed restrictions from April 14, 2020 for agriculture sector after first phase of lockdown. Government has magically taken charge over the situation to provide food security to public. India Council of Agricultural Research issued guidelines for farming activities for farming activities with physical distance and hygiene standards. Government made policies to ensure uninterrupted supply chain of milk, vegetables and fruits and maintain smooth agribusiness operations throughout the country.

## LITERATURE REVIEW

### 1. GLOBAL SCENARIO

An unprecedented rise in food storage pushes price hiking of agricultural produce. Myanmar, Vietnam suffering from labor shortages and logistics disturbances while Thailand continued to export. China suffered from surge in rice demand witnessing import by 60 percent. Malaysia and Philippines have stock piled importing from Thailand, Cambodia and India. Myanmar and Laos government has paused loans and Micro Finance Institution also suspended operations. Covid-19 caused food insecurity as decline in income because of stringent lockdown globally. As per the author, covid-19 facilitated uncertainty for farmers and job losses (Fox, Promkhambut, and Yokying 2020). Latin America faced problem of falling of commodities and decline in export volume in China, U.S.A. and Europe (Karolien and Hogenboom 2020). Sub Saharan African countries mitigate effects of pandemic. Trade policies augmenting domestic food supply by releasing grain via Food Reserve Agency (FRA). Imported agricultural products ranging from essential staples maize, wheat, rice to fruits, vegetables meat and processed food pandemic affected food supplies through commodity price volatility, availability of food supplies and farmers' planting decision. Author highlighted disruptions in key market of different countries in respect of agricultural commodities. Larger food system subjected to vulnerability, so political leaders more aggressively put pressure on private sector to remain operational. African government made strategic interventions to contain effect of food market under two categories-: (a) FRA operations, restricting/facilitating regional cross border trade. (b) food production policies- targeting small holder farmers through input subsidies to ensure timely provisions of inputs and credit finance (Sihlobo, Kapuya, and Baskaran 2021). E-commerce enables farmers to sell products and mitigate pandemic impacts on farmers' income losses. Agricultural insurance played important role in stabilizing farmers' vegetables production and supply. Improvements in agricultural insurance policies, eighty percent intended to buy agriculture insurance. Food market instability and price fluctuations raise consumers food safety knowledge and change their behavior (GU and WANG 2020). World Bank and credit rating agencies have reduced India's development for financial year 2022. Owing to lockdown, around fifty three percent of enterprises across the country will be chained into stress and lack of transparency in streamlining about essential commodities (Das 2020).

## 2. INDIAN SCENARIO

In India agricultural labors and workers migrated to urban areas unable to return to their villages. Unavailability of these labors disrupted harvesting activities. Agricultural labour supply declined in 70% of districts according to a survey done by NABARD. Farm gate prices have not declined significantly in crop sector whereas prices in allied sector had declined from 2% to 18%(NABARD 2020). Media reports show that closure of hotels, restaurant, sweet shops and tea shops during lockdown depressed milk sales. Poultry farmers hit badly due to myth spread amid chicken are carriers of covid 19 (Sandeep Kumar et al. 2020). Restriction on interstate movement of harvesters hampered post-harvest activities such as threshing, winnowing, loading and storage and transportation of agri-produces to mandis. Barriers on number of farmers' entry in mandis and quantities they can sell lead to hike in prices of agri-produces. For example in Rohtak, Haryana procurement of wheat and mustard at local mandis began on April 2020. Unlike past they had to wait for grant of token to enter into mandis with produces. In Ranchi and Jharkhand farmers forced to sell vegetables on low prices to agents who come to village on alternate day (Rawal et al. 2020). Majority of consumers (75.31%) experienced price increase due to inaccessibility to food market. Producer benefited less and consumers paid more. A divergence between retail and wholesale prices observed. This divergence indicate a widened gap between farm gate prices and consumer prices, a direct result of lockdown (Cariappa et al. 2021). Over 80 % farms reported some extent decline in sales and over 20% farms reported devastating declines. Price reductions reported by 80% farmers. Women farmers less suffered from lack of labour but more suffered from low prices of agro commodities. Women experienced a stronger disruption to price of their vegetables. Farmers experienced reductions in sales due to covid-19 sold their produce through multiple marketing channel and through collectors and middlemen (Harris et al. 2020). Author analyzed weekly average food prices from March to May. In result found that while staple grain prices remained stable, prices for nutritious food like pulses and vegetables and eggs have risen. Surge in demand due to disruptions in supply chain caused a sustained in retail prices for all pulses. Onion retail prices more than doubled in all cities attributed to low arrivals because of transportation bottlenecks. Stability in cereal prices directly associated with their status

Urban resident all over India find it difficult to buy groceries as commodities became scare in beginning of pandemic. The major reason was panic buying and hoarding among people. Restrictions on food supply chain increases the transaction cost and consumer prices. Speculative hoarding may occur and trigger price increases. An increase in demand for pulses as a result of panic buying and disruptions in supply chain contributed to rising trend in prices. Disruptions in supply chain included inability of farmers to move produce to Agricultural Produce Marketing cooperatives because of lack of transport. Constraints in supply chain began easing from May onwards (Imai 2020). Initially lockdown adversely affected agriculture and food supply chains. However on passage of two months of lockdown activities seems to have been recovering to some extent. Retail prices of cereals and vegetables which had gone up have been reversing. Rabi crop period witnessed high production of wheat, mustard, gram sesame etc.

Agriculture proved to be saving grace for Indian economy as manufacturing and manufacturing recorded a negative growth financial year 2021. The provisional estimates of National Statistical Office (NSO) shows GDP growth in agriculture increased from 2.4 percent in financial year 2020. Trade in agriculture improved in 2019-2020 as nominal GDP growth rate accounted 11.4 percent as compared to real growth 4 percent (Dev Mahendra and Sengupta 2020). Despite restrictions that government has imposed on mobility of labor, although with some problems, supply of basic necessities normally assured. Interruptions to food transfer was minimal ensuring stable food supply(Agropecuaria and 2020 n.d.)

Union Home Ministry in a very momentous move, notified to keep out movement of farmers, farm labors and harvesting and sowing related machines from purview of lockdown(Padhee 2020). A phone based surveys covering 1515 farmer in Indian States Odisha and Haryana provided insights on how farmers' livelihood disrupted and how they responded to these challenges. Winter pulses harvested manually during March and April, protected by Minimum Support Prices. Central government allowed some exceptions in guidelines of lockdown impositions. No restrictions on agricultural activities, marketing of agricultural goods, customs hiring and inter-state movement of agricultural equipments and manufacturing activities of agricultural inputs. These exceptions maintained in further guidelines supported by opening up of more agri-inputs stores, machinery repair shops and agribusiness. Hundred farmers entering mandis per day as number of mandis increased from 477 to 2000 and nearly 5 lac farmers who had registered for this procurement system able to sell their produces this way. Odisha state government announced procurement of pulses and oilseeds through a range of channels including state marketing federations, cooperative societies, farmer producer organization and village marketing commodities (Ceballos, Kannan, and Kramer 2020). A considerable resilience on agricultural business

transactions during covid-19 shocks which buffered by adequate policy support. Consumers buying behavior has changed with greater online transaction and home delivery services (Varshney, Roy, and Meenakshi 2020). Technological options such as direct seeded rice, staggered nursery transplanting and crop diversification helped in addressing these challenges but require new approaches to policy and incentives for change (Balwinder-Singh et al. 2020).

State governments rescued farmers by providing online platform for direct selling of mangoes. Karnataka State Mango Development Corporation and Marketing Corporation Limited (KSMDMCL) started a portal (Krishimangoes.karnataka.gov.in) for helping farmers to sell mangoes. Department of Horticulture, Government of Telangana in association with Telangana State Horticulture Development Corporation Limited started a web portal named T-Fresh (t.fresh.org) to supply fresh fruits and vegetables to consumers at a doorstep. Many progressive farmers and wholesalers partnered with food delivery apps for direct selling of mangoes (Kunal Mazumdar 2020).

After removing restrictions loss in highly perishable products – tomato led to shrink in prices. Food Corporation of India released cereal in open market to manage any pending shortfall in their supply. Pandemic period record high rabi procurement prevented any immediate shortage of wheat and rice (Payal Seth 2020). Rise in non-cereal prices diverted consumer spending toward staples. Food Corporation of India and state run granaries manage staples from time to time, supply additional grain in open market to stabilize prices. Central government has taken extensive measures to curtail adverse impact of covid-19 on agricultural sector (Bhaskar Mittra 2020). To ensure food security to vulnerable sections, government continued with subsidized pricing under National Food Security Act (Economy Survey 2020).

Disruptions created by covid-19 induced lockdown negatively affected the performance of non-agricultural sector but agriculture came up with a robust growth rate of 3.4% at constant prices during 2020-21. Various measures and policies on credit, market reform and food processing under Atma Nirbhar Bharat announcements push a thrust in agriculture sector. Under this package 5 kg per person per month distributed for 4 months (May-Aug). under Pradhan Mantri Garib Kalyan Anna Yojna, 1809.60 beneficiaries provided additional food grains. Amidst all adversities due to pandemic, continuous supply of agricultural commodities especially rice, wheat, pulses and vegetables had maintained to enable food-security. Agriculture credit flow target for year 2019-20 was fixed at 1350000 million and against this target achievement was 13924690.10 million. Agriculture Infrastructure Fund announced as part of Atma Nirbhar Bharat Abhiyan boost credit flow to agriculture sector. Ministry of Food Processing and Industries launched PM-Formalisation of Micro Food Processing Enterprises with total outlay 100 billion over a period of 2020-25. Central government assistance of 36.7982 billion released to state government to meet the expenditure incurred on intra-state movement of food-grains (Economy Survey 2020).

In November 2020, Production Linked Incentive Scheme introduced in 10 key sectors including food processing sector for enhancing India's manufacturing capabilities and export. As per commerce industry, India's export has beaten the pandemic crises recording a growth of 17.34 percent to \$ 41.25 billion in 2020-21. Outstanding growth of agri-exports in financial year 2021 after it remained stagnant for past 3 years (Tiwari 2020). Press Information Bureau declared that measures taken during pandemic ensured uninterrupted export. Despite covid-19 crises, balance of trade in agriculture has improved by 42.16%. Largest market for India's agriculture products are – China, USA, Bangladesh, UAE, Vietnam, Saudi-Arabia, Indonesia, Nepal, Indonesia (102.42%), Bangladesh (95.93%), and Nepal (50.49%). Government make arrangement for online issuance of various certificates required for exports. During lockdown period, virtual inspection introduced for new pack house applicants. Agriculture Export Policy Development Authority has developed, in house, a platform for organizing virtual trade fairs (VTF) to establish contact between Indian exporters and importers (Bureau 2021).

## **RESEARCH METHODOLOGY**

### **OBJECTIVES:-**

- 1- To assess the contribution of agriculture sector with respect to industry and service sector to Economy of India during pandemic crises.
- 2- To understand trend of FDI inflow in agriculture sector during pandemic.
- 3- To examine registered growth in agriculture export recorded in pandemic year 2020-21 from previous years.

**DATA COLLECTION**

Data has taken from secondary sources including literature from Government of India websites, Indian agricultural organizations’ report, international organizations’ websites, local media reports, research papers and newspapers.

**DATA AND INTERPRETATION**

**OBJECTIVE 1:-**

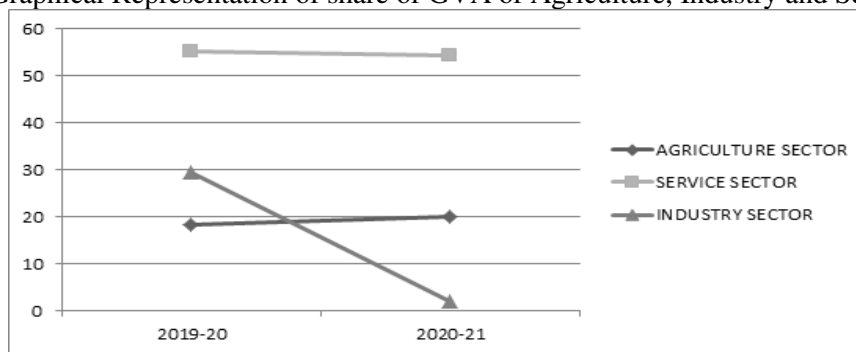
To assess the contribution of agriculture sector with respect to industry and service sector to economy of India during pandemic crises.

**Table 1-**Share of GVA (Gross Value Added) of Agriculture, Industry and Service Sector in 2019-20 &2020-2021

S.NO.	Sectors	2019-20 (%)	2020-21 (%)
1	Agriculture Sector	18.4	20.19
2	Service Sector	55.3	54.3
3	Industry Sector	29.6	24.29

Source:- Press Information Bureau, Economic Outlook

**Graph 1-** Graphical Representation of share of GVA of Agriculture, Industry and Service Sector.



**INTERPRETATION**

Table 1 shows that share of GVA of service sector and industry sector both declined by 0.0180 percent and 5.31 percent whereas GVA of agriculture sector increased by 0.097 percent in 2020-21 in comparison to previous year. Graph 1 shows the share of GVA of Agriculture, Industry and Service Sector.

**OBJECTIVE 2:-**

To understand trend of FDI inflow in agriculture sector during pandemic.

**Table 2:-** FDI Inflows in the Agriculture Sector in India

Year	Amount of FDI Inflows	Rate of Change
(In Rs. Crore)	(In US Dollar Million)	
2012-13	1392 257	
2013-14	845 140	-0.455
2014-15	796 130	-0.071
2015-16	673 103	-0.207
2016-17	618 92	-0.106
2017-18	821.3 127.4	0.384
2018-19	664.7 93.9	-0.262
2019-20	1040.64 148.04	0.576
2020-21 (April-Sep)	1502.72 201.07	0.358

Source: Department for Promotion of Industry and Internal Trade (DPIIT)

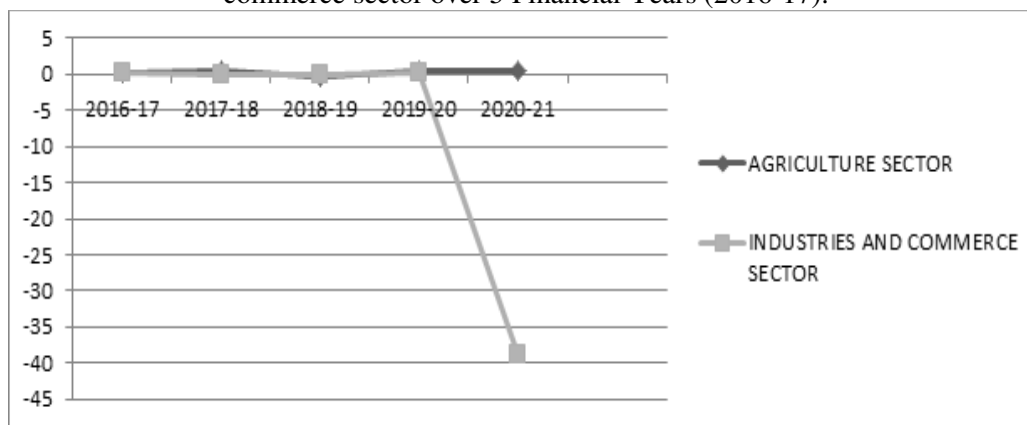
**TABLE 3:-** FDI Equity and total FDI Inflow in Commerce and Industry Sector

Year	FDI Equity inflow	Total FDI Inflow	Rate of Change
	(US \$)	(US \$)	
2015-2016	40.00	55.56	
2016-17	43.48	60.22	0.083

2017-18	44.86	60.97	0.012
2018-19	44.37	62.00	0.016
2019-20	49.98	74.39	0.199
2020-21(up to Sep,2020)	30.00	39.9	-38.9

Source:- Reserve Bank of India

GRAPH 2- Graphical representation of rate of change in FDI inflows in agriculture and industries and commerce sector over 5 Financial Years (2016-17).



### INTERPRETATION

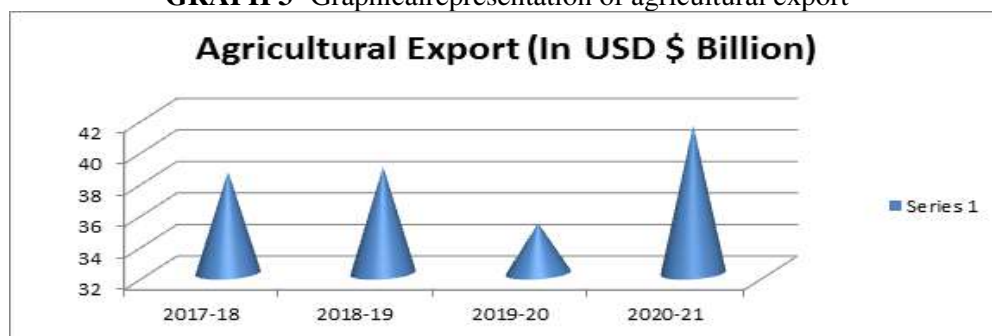
Table 2 accounted for FDI inflows in agriculture sector in India from financial year 2012-2013. Table 3 represent FDI equity and total FDI inflow in Commerce and Industry sector from 2015-16 to 2020-21. Graph 2 shows that there is positive rate of change in FDI inflow in agriculture sector whereas industries and commerce sector passes through a decline phase in attraction of FDI.

Table 4: Agricultural export from 2017-18 to 2020-21

S. NO.	Year	Export (In USD \$ Billion)
1	2017-18	USD 38.43
2	2018-19	USD 38.74
3	2019-20	USD 35.16
4	2020-21	USD 41.25

Press Information Bureau.

GRAPH 3- Graphical representation of agricultural export



### INTERPRETATION

Table 4 represent agricultural export from 2017-18 to 2020-21. Table shows that agricultural export in financial year 2020-21 increased by 0.173 percent from its previous financial year 2019-20. Graph 3 shows a comparative representation of agricultural export from 2017-18 to 2020-21 which shows that export in agriculture sector boost even during pandemic time.

### DISCUSSION

From above it is envisaged that agriculture the only sector contributes to economy. Initially agriculture sector also stuck in traps of impacts of coronavirus. Worst happened to agriculture field when pandemic hitting harvesting rabi crops. Farmers community about to shaken specifically those who primarily depend on agriculture for their livelihood. A darkness in agriculture sector magically managed by Government of India.

Indian Council of Agriculture Research in association with central government exempted agriculture and allied activities from lockdown restrictions including agencies engaged in procurement of agricultural products and mandis operated by Agricultural Produce Marketing committee. Farmers instructed by ICAR to wear mask during threshing, winnowing, grading, sorting and packaging operations at farm level as it protect them against aerosol and dust particlesto prevent them from respiratory disease. They have to ensure proper drying of packaging stuff prior to storage of grains and not to use previous season jute bags. Use treated and a gunnies after soaking in 5 percent neem solution. Government of India has initiated to help farmers by announcing that first installment of PM-KISAN Yojana payment (Rs 2000) to farmers will be paid up to farmers. RBI announced a moratorium on agriculture term loans for a period of three months. Indian Railway eased the transport logistics of agricultural produce (Nayyar 2020). Prices of essential commodities remained stable due to better supply chain management and procurement picked up in May and June 2020. Central government announced social assistance package of 25 billion US dollar. Pradhan Mantri-Garib Kalyan Yojna provided additional benefits to farmers and rural household (Joshi 2021). Ministry of Finance made announcement of economic stimulus package worth USD 22.2 billion. Fifteen percent of package allocated to agriculture sector. Under the action plan, Atmanirbhar Bharat Abhiyan (Self-Reliant Initiative) launched. Under the initiative NABARD provide fund to small and marginal farmers. Micro Food Enterprises supported in technical up gradation to attain Food Safety and Standard Authority of India (FSSAI) food standards lead to growth in retail and export market. Operation Green – “top to total” extend from tomatoes, onion and potatoes to all fruits and vegetables (Rahul Kapur 2020). Pandemic proved to be catalyst pushing agriculture sector to rise up with innovative solutions for uncertainties by lockdown. Social distancing hit on ground of advisory services, so more farmers shifted to online portal to discuss their crop issues. Agricultural networking platforms increased by thirty percent. Agri tech companies found virtual ways to inform and educate rural farmers about advancements and usage of technological innovation and their services and sell their products through e-commerce nationwide (Shukla 2020). Various initiatives taken by government to boost agriculture export during pandemic time as Transport and Marketing Assistance (TMA) scheme for marketing and export of specified agricultural produces and to promote brand recognition for Indian agricultural products in the specified overseas markets. Agriculture sector registered a positive Foreign Direct Investment while other sectors attracted negative FDI.

## SUGGESTIONS

Global pandemic affect every walks of life. Agriculture sector no remained untouched. Indian government magically handled worst situation ever in agriculture. Additionally it can more to go as coordinated policy responses needed to support agri-business and working conditions of millions of agricultural worker in line with various relevant international labor standard. Online transaction tools like Google Pay, Paytm, PhonePe more to be promoted to smoothing the agri-business related transactions. ICT infrastructure e-choupal, Kisan rath and many more apps and online platforms should penetrate among small and marginal farmers. Online delivery partners like Groffers, bigbasket should grant recognition to work with government organization because their real time delivery very fast. Door step meals delivery partners working in India as swiggy and zomato shown a dramatic increase in demand as they follow safety measures as they follow safety measures of lockdown. They claim to provide hundred percent safety measures of safety and cleanliness from preparation of food to delivery at door step. Government should provide incentive and funds to establish larger number of agri-entrepreneurs and support local value addition. More impetus should flow in agricultural infrastructure including, storage, logistics and transportation. Measures must be taken to efficiently utilize IT infrastructure in agri business to reach the unreach. Strengthening supply chain of agri-business to make it useful farmers as well as small, medium and large enterprises. Strengthening community based enterprises, federations and cooperatives to utilize larger base. Government already planned to connect all agri-market e-NAM (National Agriculture Market) in financial year 2021- 2022. Government should create space for more innovation in agriculture sector, whether it is farm practice or IT based agribusiness from farm to agro-processing industries.

## REFERENCES

1. Agropecuaria, R Siche - Scientia, and undefined 2020. n.d. “What Is the Impact of COVID-19 Disease on Agriculture?” Scielo.Org.Pe. Accessed September 18, 2021. [http://www.scielo.org.pe/scielo.php?pid=S2077-99172020000100003&script=sci\\_arttext&tlng=en](http://www.scielo.org.pe/scielo.php?pid=S2077-99172020000100003&script=sci_arttext&tlng=en).
2. Balwinder-Singh, Paresh B. Shirsath, M. L. Jat, A. J. McDonald, Amit K. Srivastava, Peter Craufurd, D. S. Rana, et al. 2020. “Agricultural Labor, COVID-19, and Potential Implications for Food Security and Air Quality in the Breadbasket of India.” *Agricultural Systems* 185 (September): 102954. <https://doi.org/10.1016/j.agsy.2020.102954>.

3. Cariappa, AG Adeeth, Kamlesh Kumar Acharya, Chaitanya Ashok Adhav, R. Sendhil, and P. Ramasundaram. 2021. "Impact of COVID-19 on the Indian Agricultural System: A 10-Point Strategy for Post-Pandemic Recovery." *Outlook on Agriculture* 50 (1): 26–33. <https://doi.org/10.1177/0030727021989060>.
4. Ceballos, Francisco, Samyuktha Kannan, and Berber Kramer. 2020. "Impacts of a National Lockdown on Smallholder Farmers' Income and Food Security: Empirical Evidence from Two States in India." *World Development* 136: 105069. <https://doi.org/10.1016/j.worlddev.2020.105069>.
5. Dev Mahendra, S., and Rajeswari (IGIDR) Sengupta. 2020. "COVID-19 Impact on the Indian Economy - Detailed Analysis." *Igidr*, no. April: 1–48. <https://blog.smallcase.com/the-new-normal-analysis-of-covid-19-on-indian-businesses-sectors-and-the-economy/>.
6. Fox, By Jefferson M, Arunee Promkhambut, and Phanwin Yokying. 2020. "Impact of COVID-19 on Rice Farmers in Southeast Asia." *East-West Wire*, no. June: 42–44.
7. GU, Hai ying, and Chang wei WANG. 2020. "Impacts of the COVID-19 Pandemic on Vegetable Production and Countermeasures from an Agricultural Insurance Perspective." *Journal of Integrative Agriculture* 19 (12): 2866–76. [https://doi.org/10.1016/S2095-3119\(20\)63429-3](https://doi.org/10.1016/S2095-3119(20)63429-3).
8. Harris, Jody, Lutz Depenbusch, Arshad Ahmad Pal, Ramakrishnan Madhavan Nair, and Srinivasan Ramasamy. 2020. "Food System Disruption: Initial Livelihood and Dietary Effects of COVID-19 on Vegetable Producers in India." *Food Security* 12 (4): 841–51. <https://doi.org/10.1007/s12571-020-01064-5>.
9. Imai, Katsushi S. 2020. *Global Development The Covid-19 Impact on Food Prices in India*.
10. Karolien, Teijlingen, and Hogenboom. 2020. "Policy Brief: COVID-19 Impact on the Value Chain in Latin America," no. 2020: 3. [clingendael.org/sites/default/files/2020-07/Policy\\_Brief\\_COVID-19\\_impact\\_value\\_chain\\_Latin\\_America\\_July\\_2020.pdf](https://clingendael.org/sites/default/files/2020-07/Policy_Brief_COVID-19_impact_value_chain_Latin_America_July_2020.pdf).
11. Rawal, Vikas, Manish Kumar, Ankur Verma, and Jesim Pais. 2020. *COVID-19 Lockdown: Impact on Agriculture and Rural Economy*. Society for Social and Economic Research.
12. Sandeep Kumar, M., V. Maheshwari, J. Prabhu, M. Prasanna, P. Jayalakshmi, P. Suganya, M. B. Benjula Anbu Malar, and R. Jothikumar. 2020. "Social Economic Impact of COVID-19 Outbreak in India." *International Journal of Pervasive Computing and Communications* 16 (4): 309–19. <https://doi.org/10.1108/IJPC-06-2020-0053>.
13. Sidhu, Gurpreet Singh, Jaskirat Singh Rai, Kanwarvir Singh Khaira, and Sarabjit Kaur. 2020. "The Impact of Covid-19 Pandemic on Different Sectors of the Indian Economy: A Descriptive Study." *International Journal of Economics and Financial Issues* 10 (5): 113–20. <https://doi.org/10.32479/ijefi.10461>.
14. Sihlobo, Wandile, Tinashe Kapuya, and Gracelin Baskaran. 2021. "Policy Insights Sub-Saharan Africa 's Agriculture and COVID-19 : How the Pandemic Will ( Re ) Shape Food Markets." *South African Institute of International Affairs*, no. May.
15. Varshney, Deepak, Devesh Roy, and J. V. Meenakshi. 2020. "Impact of COVID-19 on Agricultural Markets: Assessing the Roles of Commodity Characteristics, Disease Caseload and Market Reforms." *Indian Economic Review* 55 (S1): 83–103. <https://doi.org/10.1007/s41775-020-00095-1>.
16. Bhaskar Mittra, Payal Seth , Prabhu Pingali. *Pandemic Prices: COVID-19 Price Shocks and Their Implications for Nutrition Security in India*. July 16, 2020. <https://tci.cornell.edu/?publications=pandemic-prices-covid-19-price-shocks-and-their-implications-for-nutrition-security-in-india-2> (accessed 11, 2022).
17. Bureau, Press Information. "India registered excellent growth in Agriculture Exports during 2020-21." Delhi, 2021.
18. Foundation, India Brand Equity. *Indian Agriculture And Allied Industries Industry Report* . November 21, 2021. <https://www.ibef.org/industry/agriculture-india.aspx>.
19. Joshi, Deepak VarshneyAnjani Kumar Ashok K Mishra Shahidur Rashid Pramod K. *India water portal*. April 1, 2021. <https://www.indiawaterportal.org/articles/covid-19-and-social-protection-impact-agriculture-sector>.
20. Ministry of Commerce and Industry, Department for Promotion of Industry & Internal Trade. "Annual



- Report 20220-21." n.d.
21. NABARD. "Impact Assessment of COVID-19 on Indian Agriculture and Rural Economy." Mumbai, 2020.
  22. Nayyar, Mishika. april 15, 2020. <https://www.investindia.gov.in/team-india-blogs/covid-19-and-agriculture-strategies-mitigate-farmers-distress>.
  23. Organisation, International Labour. Sectoral impact, responses and recommendations. n.d. <https://www.ilo.org/global/topics/coronavirus/sectoral/lang--en/index.htm> (accessed november 30 , 2021).
  24. Organisation, World Health. Coronavirus disease (COVID-19) pandemic. n.d. <https://www.euro.who.int/en/health-topics/health-emergencies/coronavirus-covid-19/novel-coronavirus-2019-ncov> (accessed november 29, 2021).
  25. Padhee, Dr Arabinda Kumar. CONTAINING COVID19 IMPACTS ON INDIAN AGRICULTURE. APRIL 18, 2020. <https://www.icrisat.org/containing-covid19-impacts-on-indian-agriculture/>.
  26. Payal Seth, Prabhu Pingali, and Bhaskar Mitra. How Did COVID-19 Impact India's Food Prices? June 12, 2020 . <https://tci.cornell.edu/?blog=how-did-covid-19-impact-indias-food-prices> (accessed 1 1, 2022).
  27. radyot Ranjan Jena, Rajesh Kalli and Purna Chandra Tanti. "Impact of Covid-19 on Agricultural System and Food Prices: The Case of India." In Rural Health. IntechOpen Book Series, n.d.
  28. Rahul Kapur, Sonika Pruthi Gupta, T R Kesavan. Decoding agriculture in India amid COVID-19 crisis. Grant Thornton India and FICCI, 2020.
  29. Rahul Kapur, Sonika Pruthi Gupta, T R Kesavan. "Decoding agriculture in India amid covid-19 crises." 2020.
  30. Shukla, Nelanshu. india today. may 5, 2020. <https://www.indiatoday.in/india/story/farmers-up-coronavirus-lockdown-technology-1674525-2020-05-05>.
  31. —Thiruvalluvar. "Agriculture & Food Management." In Economy Survey. 2020.
  32. Tiwari, Rituraj. India's agricultural exports jump in Covid times. october 10, 2020. <https://economictimes.indiatimes.com/news/economy/agriculture/indias-agricultural-exports-jump-in-covid-times/articleshow/78590796.cms?from=md> (accessed january 2, 2022).  
welfare, ministry of agriculture and farmer. "annual report 2020-2021." New Delhi, 2020-2021.

---

---

## A Review of Indian Automobile Industry

Pankaj Gupta and Pooja Vidyarthi

Department of Commerce, JV Jain College, Saharanpur, India

### ABSTRACT

India's automobile sector is a major contributor to the country's economic prosperity and improvement in technology. About 32 million people are employed directly and indirectly by the automobile sector, which now contributes more than 7% of the total GDP. The Indian automobile sector has risen to the position of world leader as a result of strong local demand and favourable government policy. Electric vehicles (EVs) and intelligent transportation systems (ITS) are likely to undergo big changes in the Indian auto industry, as they do in many other nations, in an effort to address current problems such as traffic congestion, fuel dependence, air and noise pollution, and so on.

Keywords: Automotive, Industry, Indian, Economy, Environmental etc.

### INTRODUCTION

Economic growth has resulted in a rise in the use of raw materials and energy, reducing their availability and creating environmental issues. When it comes to keeping consumers and the natural environment safe and healthy, this has become a huge concern for businesses. Keeping environmental concerns in mind, organisations are embracing green business practises because they see the benefits of doing so. Businesses are being compelled to use green marketing strategies by government laws, public concern about global warming, and other environmental problems. This is a distinct definition of "green marketing," which is the total of efforts by corporations to make their goods less harmful to the environment by producing, promoting, packaging, and reclaiming them. There was a glaring omission from their criteria, however, when it came to the environmental impact of consumption and disposal of goods. Although material procurement and transportation in an environmentally friendly manner were not included in these standards. It is essential for companies to obtain raw materials from green sources and build green supply chain management systems in order to execute entire green marketing strategies. The term "green marketing" refers to all of the strategies used to attract and keep environmentally conscious consumers.

### Indian Passenger Car Industry

There has been a dramatic rise in industrial activity in recent decades, resulting in environmental damage and serious consequences. Since 1962, environmental issues have been brought into closer emphasis. Governments and non-governmental organisations in affluent nations are increasingly concerned about environmental issues. North American, European, and Asian industrialised nations have made significant efforts to conserve the environment, yet many of these efforts have failed to provide the expected effects. Consumer environmental consciousness is rising along with environmental legislation at the national and international levels in today's technologically advanced globe. Consumers are becoming more concerned about the environment, which is prompting companies to implement environmental policies. Companies are increasingly taking the lead in efforts to promote sustainable production and consumption patterns as a problem to be tackled by private players rather than governments. Companies began developing environmentally friendly goods to combat environmental deterioration in response to government laws and an increase in consumer environmental consciousness. They are also adopting green marketing methods including environmental advertising, eco-labelling, and eco-branding to capitalise on their environmental initiatives. Customers' awareness and understanding of green product traits and characteristics can assist firms develop a positive image of their brands as a result of these efforts.

### REVIEW OF LITERATURE

(Deniz and Onder 2017) studied "*Determinants Of Brand Equity In Green Products: The Relationships Among Green Brand Image, Green Trust And Green Satisfaction*" and discovered that "Brand" is a widely talked and researched marketing term. Name, word, symbol, or any other element that distinguishes one seller's goods and services from those of other sellers is defined as a brand by the American Marketing Association. While marketing activities help companies position items that are similar in terms of quality, usefulness, and effectiveness, brands offer a connection and relationship with customers that are distinct from those established by marketing activities.

(Hussain and Waheed 2016) studied "*Building green brand relations: The role of green brand image as significant driver*" The impact of green brand image in generating trust, connection, and commitment to a green brand was discovered by researchers. An additional benefit of the research was the creation and validation of scales to assess two new concepts: "green brand attachment" and "green brand commitment". The research provided an integrated theoretical model after conducting a literature assessment and identifying gaps. Validation using confirmatory factor analysis showed that the results were reliable, convergent, and discriminatively valid.

(Fonseca 2015) studied "*the impact of green marketing practices on consumer buying decision*" as well as discovered that colour may be a powerful motivating factor for consumers. Since then, corporations have been using green marketing methods, such as making goods more environmentally friendly and including features that have a less effect on the environment.

(Jagdev n.d.) studied "*Decoding the Indian Passenger Vehicle Market*" that the Indian automobile sector is presently responsible for roughly 7% of GDP, with a goal of increasing this to 10% by 2026 under the automotive mission plan. As the world's third biggest car market, India is expected to be a lucrative one in the not-too distant future. Passenger car demand is on the rise because of rising incomes and expectations. International passenger car manufacturers are eager to invest and join the Indian market or expand their current operations in light of these favourable developments..

(2019)studied "*Indian automotive sector: Creating future-ready organisations*" and uncovered that Now, the Indian automotive sector is experiencing five megatrends that are predicted to have a significant impact on the industry. In today's global and Indian auto markets alike, rapidly changing consumer demands, disruptive technological influence, dynamic regulatory environments, shifting patterns of mobility, and global interconnection are all having an effect on how automakers conduct business. Until recently, the sector has never seen such a wide-ranging transformation. Technology like self-driving cars and ride-hailing services are changing the way people get around.

(Miglani, 2019) studied "*The Growth of the Indian Automobile Industry: Analysis of the Roles of Government Policy and Other Enabling Factors*" and noted that India's car sector is one of the country's most significant drivers of economic development and one that participates heavily in global value chains. Because of the significant government backing, this industry has been able to carve out its own niche in Indian manufacturing. Autos made in this nation are specifically targeted towards the low- and middle-income segments of the population, making it unusual among the countries that create automobiles.

(Mu 2019) studied "*Indian Automobile Industry Analysis*"

The car industry in India is the fourth biggest in the world. During 2019, India ranked fourth in the world for automobile production and seventh for commercial vehicle production. This sector in India will generate between Rs 16.16 and 18.18 trillion (US\$ 251.4 and 282.8 billion) in revenue by 2026. According to statistics given by the Department for Promotion of Sector and Internal Trade (DPIIT), the industry received US\$ 24.21 billion in FDI from April 2000 to March 2020. (DPIIT). Between FY16 and FY20, domestic vehicle manufacturing climbed by 2.36 percent CAGR, resulting in a total of 26.36 million cars produced in the nation.

(Hasan et al. 2019) studied "*Green business value chain: a systematic review*" Since environmental repercussions must be taken into account promptly, conventional corporations are becoming more and more environmentally conscious. The findings of this research have consequences for environmental protection, social security, and commercial stability.

### **Overview of the Indian Automobile Industry**

Until the country's independence, the Indian automobile market was seen as a market for foreign automobiles, although General Motors and other manufacturers' cars were manufactured there. Servicing, dealership, financing, and maintenance of automobiles were the primary functions of the Indian automotive business. Manufacturing began after a decade of independence. Until the 1950s, India's transportation needs were mostly provided by the Indian Railways. India's car sector has experienced several difficulties since independence. The government's primary goal was to spur economic growth by implementing long-term, capital-intensive initiatives like steel manufacture. Priority was given to product quality and customer satisfaction. The government requires a licence to set up a manufacturing facility. Despite these difficulties, the industry expanded. Passenger automobile manufacturing was restricted to 40,000 units for over three decades after the country's independence. Production was limited to three companies: Standard Motors, Hindustan Motors, and Premier Automobiles. In the industry, there was no R&D or specialisation. In the beginning, workers were

inexperienced and had to learn on the job via trial and error. It was in the 1950s when Morris Oxford and Fiat 1100 were dubbed Ambassador and Premier Padmini, respectively. Nearly all of the automobiles on the road in the 1960s were designed and built in the United States. The car industry had seen considerable transformations by the decade's conclusion in the 1970s. Joint ventures for light commercial cars, for example, were strong attempts that failed. The new models, Contessa, Rover, and the Premier 118NE, went on sale. As far back as the 1980s, India's economy remained mostly socialist and closed to the outside world. Delicensing of the sector and subsequent opening up of the sector to 100 percent FDI via the automatic method marked a fresh beginning for the Indian automobile industry in 1991. India's economic reforms and deregulation have made it a desirable investment location. India has already become one of the world's fastest-growing car markets.

#### **Global automobile manufacturers –**

Increasingly, Japanese automakers Suzuki and Honda, as well as Korea's Hyundai Motor Company, depend on their Indian operations to help them grow. The fact that nine out of the top 10 global automakers have a presence in India shows just how critical the country's automotive sector is. By aggressively investing in new product development and product technology advancements, global rivals are increasingly focusing on India and generating India-centric goods. In addition, the cost structures of multinational firms are becoming competitive due to the rising use of local sourcing and development in India. Hatchbacks and sedans were the primary emphasis of many MNC OEMs when they first entered the Indian market. As a result, there is a lot of severe rivalry in the UV market. Future rivalry is projected to be more intense as global rivals bring decades of international expertise, global size, sophisticated technology, and huge financial resources with them. A decade after setting up shop in India, MNC OEMs have taken 84.9 percent of the domestic Passenger Vehicles (PV) market share and are increasingly utilising India as an export base, with 22.1 percent of their output exported. However, with a market share of 96.1%, Indian original equipment manufacturers (OEMs) continue to rule the commercial vehicle business.

#### **GOVERNMENT POLICY**

The development of India's car sector would not have been possible without the government's strong policy backing. With no minimum investment requirements and refunds on R&D spending, the government announced Auto Policy 2002 in 2002, which gave automatic clearance for foreign equity investment up to 100% and boosted R&D. The government's "Make in India" policy will play a major role in the expansion of the car sector after the shift from the UPA to the NDA. Faster Adoption & Manufacturing of Electric Hybrid Cars (FAME) was introduced by the government in April 2015 and would encompass all vehicle sectors, including hybrids and pure electric vehicles, until 2020. In order to make electric vehicles more accessible and popular, this programme provides subsidies. It is the goal of the government to turn India into a worldwide centre for manufacturing and for research and development. According to the Automotive Mission Plan (AMP) 2016–26, which was announced in January 2016, India's car industry was expected to increase fourfold between 2016 and 2026.

#### **CONCLUSION**

Environmental and consumer expectations are always putting pressure on the global automobile sector. Fuel efficiency, gas emissions, safety, and affordability are some of the challenges confronting the business. More than ever, automobile manufacturers are under intense pressure to provide automobiles that are both affordable and high quality, as well as easy to manufacture. Vehicle efficiency and fuel economy will improve as a result of the automotive industry's use of lightweight materials that fulfil these performance and cost standards. As a result, EU safety and economic requirements are impacting the selection of automobile materials, notably the vehicle mass and performance. The company's employees should be well-versed on environmental issues. When it comes to hiring new employees, companies should look for those that are environmentally sensitive and pose probing questions.

#### **REFERENCES**

1. Deniz, Arzu, and Leyla Onder. 2017. "Determinants Of Brand Equity In Green Products: The Relationships Among Green Brand Image , Green Trust And Green Satisfaction." 2(11):1–8.
2. Fonseca, Joana Cristina Gamboia. 2015. "The Impact of Green Marketing Practices on Consumer Buying Decision." ISCTE Repositório - Master Dissertation in Business Administration Supervisor: 0(0):0.
3. Hasan, Md Morshadul, Md Nekmahmud, Lu Yajuan, and Masum A. Patwary. 2019. "Green Business Value Chain: A Systematic Review." Sustainable Production and Consumption 20(5):326–39. doi: 10.1016/j.spc.2019.08.003.

4. Hussain, Khalid, and Ajmal Waheed. 2016. "Building Green Brand Relations: The Role of Green Brand Image as Significant Driver." *International Journal of Environment, Workplace and Employment* 4(2):116–38. doi: 10.1504/IJEWE.2016.080447.
5. Jagdev, Suman. n.d. "Bajaj Aurangabad Plant Workers to Get 50% Salary, Only If They Turn up on 8th and 9th of July."
6. Miglani, Smita. 2019. "The Growth of the Indian Automobile Industry: Analysis of the Roles of Government Policy and Other Enabling Factors." 439–63. doi: 10.1007/978-981-13-8102-7\_19.
7. Mu, Ari. 2019. "Indian Automobile Industry Analysis." *Journal of Chemical Information and Modeling* 53(9):1689–99. doi: 10.1017/CBO9781107415324.004.
8. PWC. 2019. "Indian Automotive Sector : Creating Table of Contents." (May).

## **A Study on Emotional Intelligence and Academic Performance of Rural and Urban Students**

**Rishika D**

Department of Commerce, KLE's Gudleppa Hallikeri Arts, Science and Commerce College, Affiliated to  
Karnatak University, Dharwad, Haveri, Karnataka, India

### **ABSTRACT**

The present 21<sup>st</sup> century is driven by technology in all phases of human life, people change and adapt to the new normality in all spheres especially this pandemic has turned life upside down for the majority. Though many new technologies were introduced and successfully being adopted by the people, education is one sector which faced a chaotic situation during the pandemic, many students, teachers and other stake holders had a bitter experience with the online classes and meetings. Education in India is a novel service which aims to upgrade the skills of the students not just by academic achievements but also mould the students to exhibit a personality with good traits, qualities and importantly building empathy. Many Institutions are striving hard for the betterment of skill development in students, the foremost concentration would be on how an Individual expresses and manages his own emotions – The Emotional Intelligence. This paper aims to find out the relationship between Emotional Intelligence and Academic Performance in rural and urban areas, effectiveness of five competencies given by Daniel Goleman is also analyzed. The findings of the paper prove that the two variables are not interdependent and all the five competencies are equally effective in determining the EI of an individual.

Keywords: Academic Performance, Competencies, Emotional Intelligence

### **INTRODUCTION**

Emotional Intelligence is a less spread topic though it was coined in the year 1990 by the eminent psychologists Peter Salovey and John D Mayer. Further, Daniel Goleman popularized the term as it had a direct impact on the success factor of an Individual, his theory on Emotional Intelligence proved a success in the field of education. The on-going pandemic the world has been facing is still not concluded and has been testing the humans in all levels, research proves that the number of cases on anxiety and depression has increased over the year and people with high score of emotional intelligence see more success than the people with low score, this factor makes emotional intelligence more imperative.

### **REVIEW OF LITERATURE**

1. Lawrence A. S., Arul & et al., (2013). The authors in their paper titled “Emotional Intelligence and Academic Achievement of High School Students in Kanyakumari District” has studied the relationship between academic achievement and emotional intelligence of students using two tools; the findings of his study prove that there is no relationship between these factors and recommended few self-motivational guest lectures, seminars by eminent educationalist which would have a favorable impact on the socio economic aspect of students.
2. Ramesh, S, Thavaraj & et al., (2016) made a study on the paper “Impact of Emotional Intelligence on Academic Achievements of College Students – A Review”, in this paper the researchers had emphasized on the success factor of entrepreneurs, made a review analysis on the earlier studies made and has highlighted that there is a significant relationship between the two variables, the findings of his study prove there is a positive relationship among the factors.
3. Praveen Kumar Pandey, Namita Gupta & et al., (2019) The authors in their paper titled “The Impression of Emotional Intelligence on University Students’ Academic Performance” has made the study to understand the effect of EI on academic performance of students, the prevailing scenario and also suggested points to improve the intelligence to the next level, his study has resulted that the relationship between the well-being and the emotionality is not positively associated with one another, further there is a positive correlation between various factors (that contains Emotionality, Well-Being, Self- Control and Sociability) of Emotional Intelligence that states that Emotionality is positively correlated with Wellbeing, Self-Control is positively correlated with Sociability, Self- Being is positively correlated with Self-Control and Emotionality s positively correlated with Sociability and concluded The faculties educating to the PG students particularly to administration need much focus on the university students than that of the university students to build up their EI levels which is much fundamental for them to contend in the current circumstances.

4. Dr. S. Chamundeswari. (2017), in her paper titled “Emotional Intelligence and Academic Achievement among Students at the Higher Secondary Level” has assessed the emotional intelligence based on Hydes scale and compared with the academic scores using various statistical tools and has concluded that there is a positive correlation between the two factors, further the study has found that students from central board schools have higher level of EI and have good academic performance compared to state board students.
5. Banat, Bassam & Rimawi, Omar. (2018), in the paper titled “The Impact Of Emotional Intelligence on Academic Achievement: A Case Study of Al- Quds University Students”, the author has evaluated EI using a 33 items index efforts to identify the impact of EI on academic achievement, the findings revealed that students indicated a high level of EI. 75.2% students exhibit a positive dependency on academic performance, recommended instructional programs to exhibit negative emotions, cross sectional study among various cultures for a broader understanding.
6. Shaikh S. J. & Ghoti R. M. (2020), In the paper titled “The Influence of Emotional Intelligence on Academic Achievement”, the author has drawn conclusion on two domains namely- self emotion appraisal and understanding of emotions, which has a positive association with EI, further the author has recommended that universities and autonomous colleges need to instill elements of EI in curriculum, activities and modules would help students and teachers to develop a vital skill for managing the emotions.

### **OBJECTIVES OF THE STUDY**

1. To study the Emotional Intelligence of rural and urban students.
2. To study the applicability of various factors under Daniel Goleman Emotional Intelligence score on the students.
3. To study the correlation between emotional intelligence and academic performance of rural and urban students

### **SIGNIFICANCE OF THE STUDY**

Generally, students from the urban cities tend to manage emotions both in personal and college life as they have wide exposure to opportunities; they meet new people, being active in social media, socialize with people and adapt quickly to the new changes. Further, the students from rural areas are hesitant to socialize with people; many students do not own a smart phone and resist for change, as they lack opportunities or sometimes do not wish to take up an opportunity.

These factors play a major role in expressing his/her own emotions, many at times students tend to suppress their emotions which might lead to depression and other mental illness. The main purpose of the study is to understand the pattern of emotions dealt with the students in rural and urban areas, in the influence of emotions on academic scores. The findings would help in drawing suggestions or ways to improve the management of emotions in rural and urban students.

### **RESEARCH METHODOLOGY**

The study was conducted by collecting the data from primary and secondary sources

#### **PRIMARY DATA**

A structured questionnaire containing fifty questions on emotions from Daniel Goleman’s Emotional Intelligence score was circulated to the students of KLE Institution at Haveri and Bangalore city. The collected data was compared with the II PUC marks scored and further analysis was done using various statistical tools.

#### **SECONDARY DATA**

Various newspaper articles, vlogs and research articles were referred for the study.

#### **SAMPLE SIZE AND TECHNIQUE**

A total of 112 respondents have been chosen for this study, of which 56 respondents were selected each from KLE Institution at Haveri (rural) and Bangalore (urban). Simple random sampling technique was used in selecting the respondents.

#### **DATA ANALYSIS – FINDINGS AND INTERPRETATION**

To test the correlation between Emotional Intelligence and Academic Performance of students, **1.Karl Pearson’s Correlation** test was applied.

**Dependent variable:** Academic Performance

**Independent variable:** Emotional Intelligence

**H0:** There is no significant relationship between Emotional Intelligence of a student from rural area and his/her academic performance.

**H1:** There is significant relationship between Emotional Intelligence of a student from rural area and his/her academic performance

	Emotional Intelligence	Academic performance
Emotional Intelligence	1	
Academic performance	0.247	1

#### INTERPRETATION

From the above table, it is concluded that since the r value is 0.247, there is a positive correlation between the two variables but weak and less important. Hence, emotional intelligence is less dependent on the academic performance of a student in rural areas.

**H0:** There is no significant relationship between Emotional Intelligence of a student from urban area and his/her academic performance.

**H1:** There is significant relationship between Emotional Intelligence of a student from urban area and his/her academic performance.

	Emotional Intelligence	Academic Performance
Emotional Intelligence	1	
Academic Performance	-0.059	1

#### INTERPRETATION

From the above table, it is concluded that since the r value is -0.059, there is a negative correlation between the two variables. Hence, emotional intelligence is not dependent on the academic performance of a student in urban areas.

Frequency Distribution - Qualitative					
	Rural		Urban		
	frequency	percent	frequency	percent	
Gender	0	0.0	Gender	0	0.0
Male	29	51.8	Male	33	58.9
Female	27	48.2	Female	23	41.1
	<b>56</b>	<b>100.0</b>		<b>56</b>	<b>100.0</b>

#### 2. Kruskal wallis test

As the Daniel Goleman's Emotional Intelligence score calculates the EI of an individual based on the total scores obtained in each of the five competencies namely Self Awareness, Managing Emotions, Motivating Oneself, Empathy and Social skill, the below test is conducted to know the effectiveness of individual competencies.

**H0:** All the five emotional competencies do not have equal effectiveness in the interpretation of emotional intelligence.

**H1:** All the five emotional competencies have equal effectiveness in the interpretation of emotional intelligence

Median	n	Avg. Rank			
32.00	56	160.55	SA		
28.50	56	105.21	ME		
31.50	56	152.15	Mo		
31.00	56	137.48	E		
31.00	56	147.11	SS		
31.00	280		Total		
		15.744	H (corrected for ties)		Table value 9.4877
		4	d.f.		
		.0034	p-value		
multiple comparison values for avg. ranks					
	42.95	(.05)	50.35	(.01)	



## INTERPRETATION

Since the calculated value 15.744 is greater than the table value 9.4877 and the p-value of 0.0034 is lesser than the alpha value of 0.05, the null hypothesis is rejected and the alternate hypothesis is accepted.

## DECISION

All the five emotional competencies have equal effectiveness in the interpretation of emotional intelligence.

### 3. Wilcoxon - Mann/Whitney Test

To analyze the main objective of the study that is, to know if there is a significant difference in the emotional intelligence of students from rural and urban areas, the below test is conducted.

**H<sub>0</sub>:** There is no significant difference between the Emotional Intelligence of students from rural and urban areas

**H<sub>1</sub>:** There is significant difference between the Emotional Intelligence of students from rural and urban areas

n	sum of ranks		
56	2778.5	Urban	
56	3549.5	Rural	
112	6328	total	
	3164.00	expected value	
	171.81	standard deviation	
	-2.24	z, corrected for ties	
	.0250	p-value (two-tailed)	

## INTERPRETATION

Since the calculated value -2.24 does not lie between the critical limits of -1.96 to +1.96, also the p value of 0.0250 is less than the alpha value of 0.05 the null hypothesis is rejected and the alternate hypothesis is accepted.

## DECISION

It is concluded that the emotional intelligence of students from rural and urban areas are significantly different.

### Figure 1: Graphical Representation

Following is the graphical representation of Emotional Intelligence and Academic Performance of students in rural and urban areas

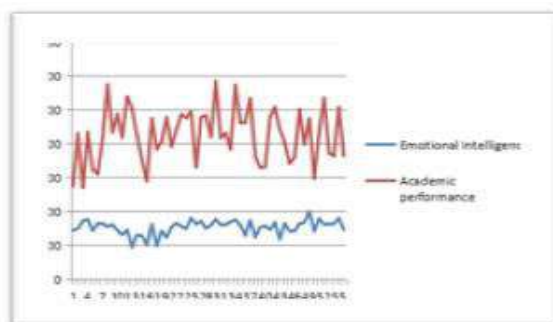


Fig 1.1

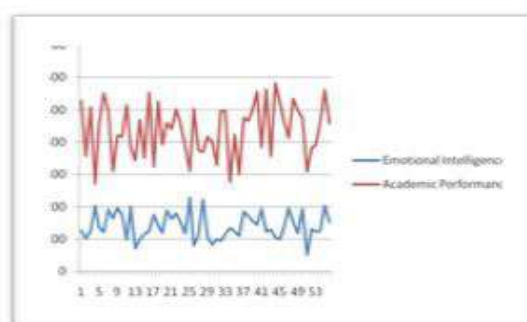


Fig 1.2

## INTERPRETATION

In both the above figures, the curve of emotional intelligence and academic performance variate in different direction and do not move in the same direction, hence the relationship between two variables are significantly different.

## SUGGESTIONS

1. In order to equip the students with necessary skills, the educational Institutions need to inculcate activities, engage motivational talks etc, which would help the students to identify, analyze and manage his/her own emotions to reach success.

2. Students may perform well in academics but hide their emotions, lack in expressing it or sometimes may not identify their own emotion, in this case it is the responsibility of the teacher, parent and the society as a whole to teach, adapt and transform the individual as a better person.
3. Each individual should try to comprehend his reactions and behaviors for the events at the end of the day, as this will help for better self-regulation.
4. The mentors at the Institution should help their mentees to develop the ability of assessing and managing his/her own emotions.
5. Students should not be resistant to change and practice to carry a positive attitude and analyze every situation with critical thinking.

### CONCLUSION

Emotional Intelligence cannot be changed as it is a built in trait of every individual, but it can be improved by way of reading, learning and developing smart skills to have a control over one's own emotions, if this practice is made right from school and college an individual can see success and lead a fulfilled life. To conclude, emotional intelligence can change the way individual sees himself, the inner personality and the people around him. It is all about behavioral manifestation.

### REFERENCES

1. Banat, Bassam & Rimawi, Omar. (2018). The Impact of Emotional Intelligence on Academic Achievement: A Case Study of Al- Quds University Students. *International Humanities Studies* Vol. 1 No.2; July 2014 ISSN 2311-7796.
2. Chamundeswari .Dr, (2017). Emotional Intelligence and Academic Achievement among Students at the Higher Secondary Level. doi: 10.6007/ijarems/v2-i4/126 url: <http://dx.doi.org/10.6007/ijarems/v2-i4/126>
3. Lawrence a. s., Arul & Sivan, T.Deepa. (2013). Emotional Intelligence And Academic Achievement Of High School Students In Kanyakumari District. *International journal of physical and social sciences*. 3. 101-107.
4. Praveen Kumar Pandey, (2019). The Impression of Emotional Intelligence on University Students' Academic Performance. *International journal of recent technology and engineering (ijrte)*, ISSN: 2277-3878, volume-8 issue-3
5. Ramesh, S & Thavaraj, Samuel & Ramkumar, Dr. (2016). Impact of Emotional Intelligence on Academic Achievements of College Students – A Review. *International journal of business management & research*. 6. 25 - 30.
6. Shaikh S. J. & Ghoti R. M. (2020). The Influence of Emotional Intelligence on Academic Achievement. *International journal of social impact*, 6(2), 07-17. dip: 18.02.002/20210601, doi: 10.25215/2455/0602002

### ANNEXURE

#### CERTIFICATE OF ORIGINALITY

This is to certify, that the research paper submitted by me is an outcome of my independent and original work. I have duly acknowledged all the sources from which the ideas and extracts have been taken. The paper is free from any plagiarism and has not been submitted elsewhere for publication.

## Role of Artificial Intelligence (AI) In Tackling Covid-19

Pradhnya M Wankhade<sup>1</sup> and Shraddha Kokate<sup>2</sup>

<sup>1</sup>Department of Information Technology, Wilson College of Arts and Science, India

<sup>2</sup>Department of IT, Saraf College of Arts and Commerce, India

### ABSTRACT

The past two decades were marked with the outbreaks of many viral diseases such as Chikungunya, Ebola, Zika, Nipah, H7N9 Bird flu, H1N1, SARS and MERS. The world woke up to this decade with a new disease outbreak. An outbreak of a novel Coronavirus emerged in Wuhan city in the Hubei province of China in December 2019. Most of the initially identified patients were traced back to the 'wet market' where live animals are slaughtered and sold. The market might have played a role as an amplification hotspot from where the virus spread to other parts of China and subsequently to 213 countries and territories in a very short time. The WHO named this disease 'COVID-19', which is an acronym of Coronavirus Disease 2019 on 11 February 2020. As of 17 August 2020, a total of 21.2 million confirmed cases and 761,000 deaths have been reported globally. The worst outbreaks of COVID-19 are reported in the USA, India, Brazil and Russia where the number of cases has surpassed the confirmed cases in China. The WHO declared the current outbreak of COVID-19 a 'Public Health Emergency of International Concern' on 30 January 2020 and a 'pandemic' on 11 March 2020.

In this paper we will study how to tackle Covid-19 situation using AI concepts.

Keywords: Transmission, Clinical Symptoms, Prevention and Control, Screening and Diagnosis, Application of AI.

### INTRODUCTION

Although the fatality rate of severe acute respiratory syndrome coronavirus 2 (SARS-CoV-2; 2.9%) is much less compared with SARS-CoV (9.6%) and MERS-CoV (34.4%), the high infectivity rate of SARS-CoV-2 compared with other coronaviruses has become a global concern. Mortality and vulnerability to COVID-19 were found to be higher in males compared with females, which could be attributed to other gendered practices such as smoking. The fatality rate of COVID-19 varied with an age gradient and it was also influenced by underlying co-morbidity, in other words, conditions such as diabetes, hypertension, cancer, cardiovascular diseases and chronic respiratory disease. Vertical transmission of COVID-19 infection from mother to baby was not observed. Children are vulnerable to COVID-19 but tend to show only mild symptoms.

### TRANSMISSION

COVID-19 mainly spreads from human to human through direct contact by respiratory droplets during coughing or sneezing and through indirect contact route by fomites and regularly touched surfaces. SARS-CoV-2 can remain viable on various surfaces for several hours to days. Air-borne transmission is possible in a medical or hospital setting in processes that generate aerosols. Although fecal-oral transmission of COVID-19 has not been reported to date, it remains a potential route.

### CLINICAL SYMPTOMS

Most patients experience mild flu-like symptoms including fever, cough, malaise, fatigue, sputum production and respiratory problems. Less common symptoms such as headache, hemoptysis and gastrointestinal symptoms with diarrhea and serious symptoms like pneumonia and bronchitis were also observed. Complications like Acute Respiratory Distress Syndrome, RNAemia, acute cardiac injury, acute kidney injury and secondary infections were reported in some patients. Other lab parameters associated with COVID-19 were low white blood cells and lymphocyte count, an increase in erythrocyte sedimentation rate, C-reactive protein, infiltrates and bilateral ground-glass opacity in lung CT scans.

### PREVENTION & CONTROL

It is imperative to adopt control measures such as case isolation, contact tracing, quarantine to limit human-to-human COVID-19 transmission. Personal hygiene measures such as frequent hand washing, respiratory hygiene, social distancing, use of face masks/shields and disinfection of surfaces can help in reducing the transmission.

### SCREENING & DIAGNOSIS

Discriminant clinical features like hyposmia (loss of smell) and hypogeusia (loss of taste) can be explored for preliminary diagnosis in telemedicine and mass screening. Specimen samples collected from oropharyngeal and nasopharyngeal swabs or blood samples are used for diagnosis. Although routinely used for COVID-19

diagnosis in outbreak settings, sole reliance on CT scans can be misleading due to indistinguishable images with other viral pneumonia. Molecular test reverse transcriptase-PCR (RT-PCR) is recommended by WHO as the method of choice for detecting the SARS-CoV-2 nucleic acid for diagnosis of COVID-19. As the false-negative rate of RT-PCR is high, it is imperative to use CT scan of the chest as a supplementary diagnostic measure to confirm the diagnosis. Point-of-care immunodiagnostic assays that detect proteins from the COVID-19 virus or human antibodies generated against the virus in blood samples are also being used routinely to complement molecular tests due to low cost and fast results, but these methods suffer from poor sensitivity and are only qualitative. Utility of these serological methods in public health settings for contact tracing and evaluating the success of nonpharmaceutical interventions has been discussed elsewhere. These serological methods have now received Emergency Use Authorization by the US FDA. CRISPR-Cas12-based assay that provides rapid results can be used in point-of-care testing in the future.

#### **Application of Artificial Intelligence in COVID-19 disease management:**

Unprecedented pace of efforts to address the COVID-19 pandemic situation is leveraged by big data and artificial intelligence (AI). Various offshoots of AI have been used in several disease outbreaks earlier. AI can play a vital role in the fight against COVID-19.

AI is being successfully used in the identification of disease clusters, monitoring of cases, prediction of the future outbreaks, mortality risk, diagnosis of COVID-19, disease management by resource allocation, facilitating training, record maintenance and pattern recognition for studying the disease trend. Several applications of AI that are garnering a lot of interest and raising hopes in the fight against COVID-19 are as follows:

#### **AI in prediction & Tracking:**

AI can be harnessed for forecasting the spread of virus and developing early warning systems by extracting information from social media platforms, calls and news sites and provide useful information about the vulnerable regions and for prediction of morbidity and mortality.

#### **AI in contact tracing:**

AI can augment mobile health applications where smart devices like watches, mobile phones, cameras and range of wearable device can be employed for diagnosis, contact tracing and efficient monitoring in COVID-19.

#### **AI in monitoring of COVID-19 cases:**

AI techniques are applied for monitoring patients in clinical settings and prediction of course of treatment. Based on the data derived from vital statistics and clinical parameters, AI may provide critical information for resource allocation and decision-making by prioritizing the need of ventilators and respiratory supports in the Intensive Care Unit.

#### **AI in early diagnosis:**

AI was used for the detection and quantification of COVID-19 cases from chest x-ray and CT scan images. Researchers have developed a deep learning model called COVID-19 detection neural network (COVNet), for differentiating between COVID-19 and community-acquired pneumonia based on visual 2D and 3D features extracted from volumetric chest CT scan.

#### **AI in reducing the burden from medical practitioners & healthcare staff:**

AI-based triage systems can help in reducing the work burden of medical staff and healthcare workers by automating several processes such as imparting training to practitioners, determination of the mode of treatment and care by analyzing clinical data using pattern recognition approaches, digitalization of patient's reports and also by offering solutions that minimize their contact with the patients.

#### **AI in protein structure prediction:**

AI can help in predicting the structure of important proteins crucial for virus entry and replication and provide useful insight that can pave way for drug development in a very short time.

#### **AI in development of therapeutics:**

AI techniques can boost and complement traditional technologies by reducing the time required in bringing a drug from bench to bed by speeding up lead discovery, virtual screening and validation processes by a huge margin.

#### **AI in development of vaccines:**

Never before has mankind witnessed such a race for the development of a vaccine against a pathogen. The pace of the discovery can be accelerated manifold by harnessing the power of AI.

**AI in curbing spread of misinformation:**

Due to the avalanche of information, this pandemic has turned into an infodemic. Understanding knowledge, awareness and practices toward COVID-19 by tapping information from social media platforms like Twitter, Facebook etc. can help in devising the strategy to assemble and disseminate timely and correct information for mitigating the impact of COVID-19.

**CONCLUSION & FUTURE PERSPECTIVE**

Adopting a three-pronged approach based on testing, isolation and contact tracing is warranted to combat COVID-19. It is necessary to exploit the available knowledge base to develop effective chemotherapeutic agents against COVID-19, taking cues from lessons learnt in the past during other such outbreaks.

**REFERENCES**

1. World Health Organization. Coronavirus disease 2019 (COVID-19): situation report. 156 (2020). [www.who.int/docs/default-source/coronaviruse/situation-reports/20200624-covid-19-sitrep-156.pdf?sfvrsn=af42e480\\_2](http://www.who.int/docs/default-source/coronaviruse/situation-reports/20200624-covid-19-sitrep-156.pdf?sfvrsn=af42e480_2)
2. Cai H. Sex difference and smoking predisposition in patients with COVID-19. *Lancet Respir. Med.* 8(4), e20 (2020). [PMC free article] [PubMed] [Google Scholar]
3. Guan W, Ni Z, Hu Y. et al. Clinical characteristics of coronavirus disease 2019 in China. *N. Engl. J. Med.* 382(18), 1708–1720 (2020). [PMC free article] [PubMed] [Google Scholar]
4. Ruan S. Likelihood of survival of coronavirus disease 2019. *Lancet Infect. Dis.* 20(6), 630–631 (2020). [PMC free article] [PubMed] [Google Scholar]
5. Verity R, Okell LC, Dorigatti I. et al. Estimates of the severity of coronavirus disease 2019: a model-based analysis. *Lancet Infect. Dis.* 20(6), 669–677 (2020). [PMC free article] [PubMed] [Google Scholar]
6. Yu N, Li W, Kang Q. et al. Clinical features and obstetric and neonatal outcomes of pregnant patients with COVID-19 in Wuhan, China: a retrospective, single-centre, descriptive study. *Lancet Infect. Dis.* 20(5), 559–564 (2020). [PMC free article] [PubMed] [Google Scholar]
7. Kelvin AA, Halperin S. COVID-19 in children: the link in the transmission chain. *Lancet Infect. Dis.* 20(6), 633–634 (2020). [PMC free article] [PubMed] [Google Scholar]
8. Kim J-M, Chung Y-S, Jo HJ. et al. Identification of coronavirus isolated from a patient in Korea with COVID-19. *Osong. Public Health Res. Perspect.* 11(1), 3–7 (2020). [PMC free article] [PubMed] [Google Scholar]
9. Walls AC, Park YJ, Tortorici MA, Wall A, McGuire AT, Veesler D. Structure, function and antigenicity of the SARS-CoV-2 spike glycoprotein. *Cell* 18(2), 281–292 (2020). [PMC free article] [PubMed] [Google Scholar]
10. Wang Q, Qiu Y, Li JY, Zhou ZJ, Liao CH, Ge XY. A unique protease cleavage site predicted in the spike protein of the novel pneumonia coronavirus (2019-nCoV) potentially related to viral transmissibility. *Virol. Sin.* 20, 1–3 (2020). [PMC free article] [PubMed] [Google Scholar]
11. Lu R, Zhao X, Li J. et al. Genomic characterisation and epidemiology of 2019 novel coronavirus: implications for virus origins and receptor binding. *Lancet* 395(10224), 565–574 (2020). [PMC free article] [PubMed] [Google Scholar]
12. Khailany RA, Safdar M, Ozaslan M. Genomic characterization of a novel SARS-CoV-2. *Gene Rep.* 100682, 1–6 (2020). [PMC free article] [PubMed] [Google Scholar]
13. Mousavizadeh L, Ghasemi S. Genotype and phenotype of COVID-19: their roles in pathogenesis. *J. Microbiol. Immunol. Infect.* (2020) (Epub ahead of print). [PMC free article] [PubMed] [Google Scholar]
14. Tang B, Bragazzi NL, Li Q, Tang S, Xiao Y, Wu J. An updated estimation of the risk of transmission of the novel coronavirus (2019-nCov). *Infect. Dis. Model.* 5, 248–255 (2020). [PMC free article] [PubMed] [Google Scholar]
15. Cai J, Sun W, Huang J. et al. Indirect virus transmission in cluster of COVID-19 cases, Wenzhou, China, 2020. *Emerg. Infect. Dis.* 26(6), 1343–1345 (2020). [PMC free article] [PubMed] [Google Scholar]

- 
16. van Doremalen N, Bushmaker T, Morris DH. et al. Aerosol and surface stability of SARS-CoV-2 as compared with SARS-CoV-1. *N. Engl. J. Med.* 382(16), 1564–1567 (2020). [PMC free article] [PubMed] [Google Scholar]
  17. Chen Y, Chen L, Deng Q. et al. The presence of SARS-CoV-2 RNA in feces of COVID-19 patients. *J. Med. Virol.* 92(7), 833–840 (2020). [PubMed] [Google Scholar]
  18. Hindson J. COVID-19: faecal-oral transmission? *Nat. Rev. Gastro. Hepat.* 17(5), 259–259 (2020). [PMC free article] [PubMed] [Google Scholar]
  19. Huang CT, Lin HH, Ruan SY. et al. Efficacy and adverse events of high-frequency oscillatory ventilation in adult patients with acute respiratory distress syndrome: a meta-analysis. *Crit. Care* 18(3), R102 (2014). [PMC free article] [PubMed] [Google Scholar]
  20. Bénézit F, Turnier PL, Declerck C. et al. Utility of hyposmia and hypogeusia for the diagnosis of COVID-19. *Lancet Infect. Dis.* 20(9), 1014–1015 (2020). [PMC free article] [PubMed] [Google Scholar]

---

---

## The Healthcare System in India

**Pradeep H. Tawade**

Department of Accountancy, NSS College of Commerce and Economic, Tardeo, India

### ABSTRACT

India has a huge health care framework; however there stay numerous distinctions in quality among rustic and metropolitan regions just as among public and private medical care. Regardless of this, India is a famous objective for clinical sightseers, given the generally low expenses and top calibre of its private medical clinics. Worldwide understudies in India ought to hope to depend on private clinics for cutting edge clinical consideration.

Contemplating in India offers various wellbeing challenges that understudies from created nations might be unused to, so know how the medical care framework in India works.

Keywords: India, health care framework, wellbeing, medical, metropolitan regions, etc.

### INTRODUCTION

India's healthcare industry has been developing at a Compound Annual Growth Rate of around 22% starting around 2016. Going on like this, it is relied upon to arrive at USD 372 Billion of every 2022. Medical services have become perhaps the biggest area of the Indian economy, as far as both income and work. In 2015, the medical services area turned into the fifth biggest business, utilizing 4.7 Million individuals straightforwardly. According to gauges by the National Skill Development Corporation (NSDC) medical services can create 2.7 Million extra positions in India between 2017-22 - more than 500,000 new positions each year.

India's healthcare industry contains emergency clinics, clinical gadgets and gear, health care coverage, clinical preliminaries, telemedicine and clinical the travel industry. These market portions are relied upon to enhance as a maturing populace with a developing working class progressively leans toward safeguard medical care. Also, the rising extent of way of life sicknesses brought about by elevated cholesterol, hypertension, stoutness, less than stellar eating routine and liquor utilization in metropolitan regions is helping interest for specific consideration administrations.

Notwithstanding these segment and epidemiological patterns, COVID-19 is probably going to catalyze long haul changes in mentalities towards individual wellbeing and cleanliness, health care coverage, wellness and nourishment just as wellbeing observing and clinical check-ups. The pandemic has additionally sped up the reception of advanced advances, including telemedicine.

### SIGNIFICANCE OF THE STUDY

This paper mainly discusses about the conceptual framework of healthcare system in India. It strives to describe the benefits and future of healthcare system in India.

### RESEARCH METHODOLOGY

The prepared paper is a descriptive study in nature. The study has been carried out based on the collection of the relevant secondary data. Secondary data collection was based on various sources such as published books, articles published in different journals & newspapers, periodicals, conference paper, working paper and websites, etc.

### OBJECTIVES

**The objectives of study were based on:**

1. To study the concept and overview of healthcare system in India.
2. To study the market size of healthcare in India
3. To understand benefit of healthcare system in India.
4. To analyse the challenges or reasons why healthcare system in India is struggling.
5. To understand Indian healthcare 2030 and beyond.

### MEANING & DEFINITION OF HEALTH CARE

Health care is the upkeep or improvement of wellbeing by means of the avoidance, conclusion, therapy, recuperation, or fix of infection, disease, injury and other physical and mental disabilities in individuals. Medical care is conveyed by wellbeing experts and united wellbeing fields.

The Healthcare business in India is comprised of clinics, clinical device, clinical preliminaries, reevaluating, telemedicine, clinical the travel industry, health care coverage, and clinical gear. The business is ascending at an exceptional speed inferable from its supported inclusion, administrations and extra consumption by the general population just as private financial backers.

### MARKET SIZE

The medical services market can build three overlap to Rs. 8.6 trillion (US\$ 133.44 billion) by 2022. In Budget 2021, India's public use on medical care remained at 1.2% as a level of the GDP.

A developing working class, combined with rising weight of new illnesses is supporting the interest for health care coverage inclusion. With expanding interest for reasonable and quality medical services, infiltration of health care coverage is ready to extend before long. In FY21, gross composed expenses in the wellbeing portion developed at 13.7% YoY to Rs. 58,584.36 crore (US\$ 8.00 billion). The wellbeing section has a 29.5% offer in the complete gross composed expenses procured in the country.

### BENEFITS OF HEALTHCARE SYSTEMS OF INDIA

- **Foreign Exchange:** Every patient spends around 3500-6000 USD in India which brings significant foreign exchange.
- **Goodwill:** Medical tourism is responsible for the establishment of goodwill for India in foreign nations. This has helped create friendliness between India and African countries and this goodwill helps in securing Indian investments overseas and progress in bilateral relations.
- **Boosting Economy:** States like Andhra Pradesh are improving their economy due to the influx of large of tourists seeking medical help.
- **Employment Generation:** Inflow of patients and money into healthcare system leads to the creation of jobs and opportunities which help in solving the unemployment crisis.
- **Promotion of alternative healthcare systems:** It helps the promotion of healthcare systems of India such as AYUSH (Ayurveda, Yoga & Naturopathy, Unani, Siddha and Homeopathy).
- **Start-up India:** With many new Start Up's like Practo, Portea, Advancells, Lybrate etc. emergent in the field of the health sector, Medical tourism can motivate setting up a number of new start-ups.



### 5 REASONS WHY INDIA'S HEALTHCARE SYSTEM IS STRUGGLING

There's a need to make individuals and cycles in the medical services area made more responsible; for that more prominent functional straightforwardness should be acquired critically.

India's medical services framework has been doing combating different issues, including the low number of foundations and not exactly satisfactory HR for a long time now.

Basically, a three-level design characterized the Indian medical care framework — essential, optional and tertiary consideration administrations. The Indian Public Health Standards (IPHS) states that the conveyance of essential medical care is given to the provincial populace through sub-focus, essential wellbeing place (PHC), and local area wellbeing focus (CHC), while optional consideration is conveyed through region and sub-region



clinics. Then again, tertiary consideration is stretched out at provincial/focal level foundations or super strength clinics.

While there is desperation to zero in on every one of the three degrees of essential, auxiliary and tertiary medical care, it is basic that the public authority look towards working on essential medical care as a public decent.

### **1. LACK OF INFRASTRUCTURE**

India has been battling with inadequate framework as absence of exceptional clinical foundations for a surprisingly long time now. To add to it, the pace of building such clinical educating or preparing offices stays less when contrasted with the need of great importance.

For a significant time frame, the public authority guideline ordered that private clinical schools should be based on no less than five sections of land of land. Therefore, many private universities were implicit rustic regions, where it turned out to be very hard to enroll sufficiently qualified, full-time specialists because of absence of legitimate day to day environments, other than low compensation scales.

It is just now that the recently comprised National Medical Commission (NMC) has advanced the plan to get rid of the necessity of least five sections of land of land for setting up a clinical school.

Further, the commission has proposed to diminish the base number of beds needed as an extent of the quantity of seats in the school.

Furthermore, the new guidelines have additionally set out the prerequisites for address theatres, libraries, labs, least bed necessity of the connected clinical school, and area of staff workplaces and convenience of understudies.

### **2. SHORTAGE OF EFFICIENT AND TRAINED MANPOWER**

Perhaps the most squeezing issues in Indium stays an extreme lack of prepared labour in the clinical stream; this incorporates specialists, attendants, paramedics and essential medical care labourers. The circumstance stays troubling in provincial regions, where very nearly 66% of India's populace lives.

The specialist to-patient proportion remains wretchedly low, which is only 0.7 specialists per 1,000 individuals. This is contrasted with the World Health Organization (WHO) normal of 2.5 specialists per 1,000 individuals. Advancing the present circumstance keeps on excess a drawn out process.

The issue can be appropriately tended to by expanding the limit of existing instructing and preparing foundations while adding new ones over the long haul.

### **3. UNMANAGEABLE PATIENT-LOAD**

Indeed, even before the flare-up of the Covid-19 pandemic, medical care offices had been feeling the strain because of unmanageable patient-load. In addition, serving a populace of 1.4 billion remaining parts a Herculean errand in itself with regards to reasonably overseeing medical care offices.

There is a need to take on innovation any place conceivable to smooth out the functional and clinical cycles for medical services offices to oversee effective patient stream. Also, there is the test to think past the self-evident and advance virtual consideration conventions, and telehealth administrations, which can be utilized to lessen the patient load weight generally.

### **4. PUBLIC HEALTH POLICY AND PROACTIVE HEALTHCARE**

The general wellbeing strategy should be focussed towards proactive medical care, not responsive medical services. In addition, on account of the public authority's Ayushman Bharat conspire, the Pradhan Mantri Jan Arogya Yojana (PM-JAY), the general health care coverage plot, has gotten extensive consideration and assets than the wellbeing and wellbeing focuses (HWCs) part. This unevenness should be reasonably tended to for the development of medical services later on.

### **5. High out-of-pocket expenditure remains a stress factor:-**

While public emergency clinics offer free wellbeing administrations, these offices are understaffed, ineffectively prepared, and found for the most part in metropolitan regions. It's obviously true that available and reasonable medical care in the public area can impressively decrease the ascent in reliance on private organizations. Be that as it may, legislative offices leave no other options except for to get to private organizations and causing high cash based costs in medical care. Most wellbeing administrations are, in this way, given by private offices, and 65 percent of clinical costs in India are paid cash based by patients.

A potential answer for address the issue could be to build the reception of health care coverage. In such manner, the public authority and private establishments both need to cooperate. Reception of advanced protection handling arrangements incorporated with the medical care environment for quicker turnaround time for protection cycles will likewise spur reception of health care coverage.

What essentially upsets the medical care framework is that there has been an overall absence of spotlight on the vertical from the public authority. Throughout recent years, automatic response work is being seen towards the improvement of nature of administration.

To summarize it, there is desperation to make medical care administration and specialist co-ops more straightforward functionally. This will assist with guaranteeing individuals and cycles can be made effectively responsible to give better medical care administrations. It is really at that time that the medical care framework can inhale somewhat more straightforward.

#### **INDIAN HEALTHCARE 2030 AND BEYOND:-**

The year 2019 has been a troublesome stage for India's medical care area. The area encountered a few headwinds, with controllers acquiring tough arrangement intercessions, for example, value cap for drug gadgets and directed shock attacks for quality checks and so on some private medical care organizations battled to remain above water as associations combat to adjust cost and productivity. The speculation situation in medical care was likewise impacted.

In any case, fortunately industry examiners, wellbeing financial analysts, speculation specialists and the public authority all appear to predict a promising future in the following decade. The medical care market is assessed to reach \$ 372 billion by 2022.

The Ministry of Health and Family Welfare wants to additional upgrade its medical care financial plan to 2.5% of GDP by 2025. The Indian Government has likewise fostered a Sustainable Development Goals (SDG) designated to be accomplished by 2030. This is an endeavour to guarantee wellbeing, end destitution and guarantee flourishing and harmony for individuals. As a feature of this plan, one of the SDGs centres emphatically around wellbeing. It expects to advance the sound living and prosperity for individuals of all age bunches by killing all types of ailing health and accomplishing widespread admittance to safe drinking water, cleanliness and disinfection.

On the private medical care front, examiners expect a flood in the ventures. The rising reception of advanced advances, computerization and more will be the critical drivers for development. It will likewise cover patterns moulding the future medical services scene to achieve supportable wellbeing frameworks; arising advances; new age medical care and clinical schooling news, new exploration necessities, natural medical problems, joining of medical services administrations; wellbeing financing, financial aspects and protection; patient-based consideration and enabling the patient and new models of care.

#### **CONCLUSION**

Indian is one of the highest milk producing country then also per capita milk production in Indian is much low compare to other milk producing county. India is not able to meet its local milk demand. The average milk production per cow and buffalo per year in India is too low. The cost of milk in India is too high. Indian cattle farm is working on very low efficiency. ndian is one of the highest milk producing country then also per capita milk production in Indian is much low compare to other milk producing county. India is not able to meet its local milk demand. The average milk production per cow and buffalo per year in India is too low. The cost of milk in India is too high. Indian cattle farm is working on very low efficiency.

India has gained noticeable headway in wellbeing guidelines in the post-freedom time. All things considered, many feel that the monetary assets for the wellbeing area ought to be expanded. Worldwide advancements in data innovation should be applied at the public level in an endeavour for wellbeing information documentation. The proceeded with endeavours to control the nation's populace and the political assurance to walk towards the thousand years advancement objectives in wellbeing will assist India with having a significant effect on the global wellbeing scene.

Considering this specific development of Indian medical services, it is assessed that there will be an inborn requirement for more medical services and clinic executives to appropriately supply the labour expected to enhance the development of the business. Consequently there will be an increment in the requirement for schooling in this specific field. Remembering this specific need, there will be a new wave for the training

---

courses conferring information about emergency clinic organization, medical services the executives just as general wellbeing.

Rather than this development of medical care industry, all of the estimation has been disturbed because of the Coronavirus pandemic. Albeit the significance of the requirement for a set up medical care industry and the presence of gifted medical care laborers and overseers is more obvious at this point.

#### **REFERENCES**

- "Hospital beds per 1,000 people". Our World in Data. Archived from the original on 12 April 2020. Retrieved 7 March 2020.
- "A Pathway to Universal Healthcare in India". 5 July 2020
- "INDIA IS INTRODUCING FREE HEALTH CARE—FOR 500 MILLION PEOPLE". Newsweek. 16 August 2018. Retrieved 2 September 2018.
- Healthcare. India Brand Equity Foundation. Retrieved December 15, 2020.
- Ayushman Bharat – Health and Wellness Centre, Ministry of Health and Family Welfare. Government of India. Retrieved February 23, 2021

#### **WEBSITES**

- [www.google.co.in](http://www.google.co.in)
- <https://www.internationalstudentinsurance.com/india-student-insurance/healthcare-system-in-india.php>
- [https://en.wikipedia.org/wiki/Health\\_care](https://en.wikipedia.org/wiki/Health_care)
- <https://www.ibef.org/industry/healthcare-india.aspx>

## A Study on Real Estate Industry in Mumbai: A Challenge

Akshaya Bagwe<sup>1</sup> and Neelam Arora<sup>2</sup>

<sup>1</sup>University of Mumbai, BFM Department, Narsee Monjee College of Commerce and Economics, Mumbai, India

<sup>2</sup>University of Mumbai, Lala Lajpat Rai College of Commerce and Economics, Mumbai, India

### ABSTRACT

Business land area is in blast in India. Over the most recent fifteen years, post advancement of the economy, Indian land business has taken an upswing and is expected to develop from the current USD 14 billion to a USD 102 billion in the following 10 a long time because of this the investigation of the proposed research work is critical. The new development in the Indian economy has animated interest for land and grown land the nation over. Thinking about the rising interest for private, business and retail land, the Finance Bill 2012 had proposed inclusion of segment 194LAA in the ITA to deduct charge via TDS @ 1% on thought for move of undaunted property (other than farming area) if the worth of the property surpasses Rs. 50 lakhs in metropolitan regions and Rs. 20 lakh if the property is arranged in some other regions so the investigation of the land area is huge. This paper studies the current day difficulties of the land area are progressively intricate and various. The business is confronting the headwinds of late administrative changes, swelling, declining request, shortage of gifted labour, significant expense of money, deteriorating selling costs and expanding land cost. Additionally, keeping up with believability while meeting client assumptions as far as quality and convenient conveyance is another major challenge tormenting the area due to this the investigation of the land area is critical.

Keywords: Land, Residential Area, RERA

### INTRODUCTION

The Indian economy is as of now the second quickest developing economy on the planet with a normal genuine GDP development of 7% (2004). India can possibly develop at rates higher than 5% throughout the following 30 years outperforming the GDP of created economies such as Italy, Germany and Japan simultaneously. India's home-grown GDP is relied upon to develop from current \$585bn to a trillion dollars by 2012. Indian financial development over the previous decade has primarily been upheld by lightness found in utilization. India is among the not many economies in the locale where family utilization represents practically 65% of GDP. The financial development has additionally been upheld by positive changes in the segment structure like rising pay levels, changing age profile, and so forth in the country. Indian economy is encountering a primary segment change. The key elements liable for this segment change can comprehensively be ascribed to;

- a) Rising Income levels
- b) Changing age profile-somewhat youthful populace
- c) Attitudinal movements
- d) Nuclearization of families
- e) Emerging working class-300 million
- f) Rising portion of administrations organizations and
- g) Changing utilization design reserve funds rate declining and utilization expanding.

Good changes in the segment structure are likewise been upheld by the falling financing cost situation making credit less expensive and expanding monetary advantage as far as concession on head and premium reimbursements by the public authority for interests in land by people.

Family utilization keeps on being a key development driver for the Indian economy (representing about 65% of GDP) upheld by a vertical development in lodging request, which has assisted with giving some lightness to the housing market. The significance of the

lodging in land area in India can likewise be measured from the reality that for each one rupee put resources into the development of houses, an expected 75 80% (Rs0.75-0.80) is added to the GDP and the area is compliant to the improvement of more than 250 other subordinate businesses The land area is among the main 3 business generators in India. Market examination gauges gets back from land in India at a normal of 10-12% every year referenced in show 12, with an upsurge in business land by virtue of the Indian BPO and protection

blast. Rent rentals have been getting consistently and there is a vast interest for quality foundation. The lodging area has been developing at a normal of 34% every year, while the neighbourliness industry saw a development of 10-15% last year. Further, the entrance levels are still extremely low across India, notwithstanding the new development seen across lodging demonstrated by the way that the home loan to GDP proportion in the nation is about 3% analysed to more than half in the US. Notwithstanding, regardless of whether one was to benchmark with more practically identical partners, the proportion ranges between 15-20% for most South East Asian nations. In this manner the infiltration level of home loans is miniscule when contrasted and the deficiency of lodging units. Practically 80% of land created is private space and the rest involved office, shopping centres, lodgings and clinics. Business land improvement is being driven progressively by the off-shoring business, including top of the line innovation the Indian land industry has been on an exciting ride since 2005. Resulting to the public authority's arrangement to permit Foreign Direct Investment (FDI) in this area, there was a blast in speculation and formative exercises. The area not just seen the passage of numerous new home-grown realty players yet additionally the appearance of numerous unfamiliar land venture organizations including private value reserves, benefits reserve what's more, advancement organizations entered the area tricked by the significant yields on speculations. The land area has been riding through numerous highs and lows from that point forward. The industry accomplished new statures during 2007 and mid-2008, described by a development in request, significant turn of events and expanded unfamiliar ventures. Be that as it may, by mid-2008, the impacts of the worldwide financial lull were obvious here as well, and the industry took a 'U' turn. FDI inflow into land dropped fundamentally and what had arisen as perhaps the most encouraging business sectors for unfamiliar investment encountered a down turn.

**Significance and statement of the study: -**

Today, the land area is wrestling with various difficulties like lack of talented labour, heightening task cost and delayed development period. Innovation holds the way to address a portion of these issues, yet in addition a guarantee for the area to respond to the changing economic situations all the more adequately and productively because of it the investigation of the land area is huge.

The customary strategies for advertising development projects have ended up being incredibly tedious and incapable at offering helpful data of structures like plan and intending to possible clients. With clients looking for additional data for settling on educated choices while making buys, organization of innovation gives a chance to keen designers to separate their showcasing endeavours from that of their rivals. Across the area, designers are putting resources into giving virtual voyages through their undertakings to their expected clients to adequately market their undertakings while saving both time and cost. Consequently, the analyst needs to know the issues of the land area.

India has every one of the qualities to draw in global interests in the Real bequest area and give relatively more significant yields. There are sure difficulties that India needs to defeat to foster a favourable climate for drawing in economical long-haul capital hence the investigation of the land area is huge.

The Indian property market has low straightforwardness when contrasted with the more adult also, grew housing markets. In spite of the fact that market straightforwardness has improved, solid and reliable data on the Indian property market is as yet not without any problem accessible. There are additionally more expert due perseverance and valuation foundations required. This remains constant in any event, for the Tier I urban areas. So, the investigation of the land area is huge.

Loan fees, expansion and conversion scale chances are among the significant macroeconomic markers and have shown diminished unpredictability. The arrangement of offices, is in numerous districts, still insufficient (training, transport foundation). These danger factors are not liable to vanish soon, obstructing the improvement of the land area. Absence of data and low straightforwardness in the land fragment in India, combined with the deep-rooted property related issues debilitate the venture of the huge players in the semi metropolitan and rustic regions along these lines loosen a general development of the land area for all above reasons the investigation of the land area is huge.

In the proposed research work the scientist will attempt to discover appropriate answer for the accompanying difficulties or issues looked by land area in Thane locale. The key difficulties that the land business is confronting today are:

- absence of clear land titles,
- nonappearance of title protection,

- nonappearance of industry status,
- absence of sufficient wellsprings of money,
- lack of work,
- rising labour and material expenses,
- Approvals and procedural challenges.

#### **THE OBJECTIVES OF THE STUDY**

To know the current exhibition and the difficulties before the land area the specialist has chosen following destinations,

1. To investigate the course of advancement and difficulties in land in India during post change period.
2. To assess the commitment of land area to pay and work.
3. To think about the development and difficulties during Pre and Post FDI Policy.
4. To evaluate the job of land area in unfamiliar exchange.
5. To draw out the elements answerable for the land areas development.
6. To assess the difficulties looked by land area in India.
7. To examine the basic elements influencing the land esteem.
8. To introduce the future imperatives of land interest in India.

#### **HYPOTHESIS OF THE STUDY**

1. The age of pay and work by the land area increment hugely.
2. The Real Estate areas development is capable because of instruction, major league salary flexibility and foundation advancement.
3. The family from monetarily middleclass incline toward land area more than financially lower-class family.

#### **SCOPE OF THE STUDY: -**

##### **1. TEMPORAL SCOPE: -**

With the end goal of study, basically the term of the year's I. e.2002 to 2012 is thought of. Any place vital reference will make to the past and current conditions.

##### **2. GEOGRAPHICAL SCOPE: -**

An investigation has been for the most part bound to the Thane areas of Maharashtra state.

##### **3. FUNCTIONAL SCOPE: -**

The motivation behind the investigation is to obtain data about the presentation of genuine home area for government assistance of families and to think about the public authority strategy for land area.

#### **RESEARCH METHODOLOGY**

The current examination work is an investigation of the Prospects and Challenges of Real Estate Sector in India: with extraordinary Reference of Thane District." in the Maharashtra state and its significance with monetary turn of events and development, just as the expectation for everyday comforts of the people groups During the time of Ten years for example from 2002-2003 to2011-2012. This is an unmistakable, scientific, in view of chronicled realities. This is an observational examination. Thusly the examination model that is chosen that of unmistakable, observational, quantitative and recorded examination. The significant viewpoints are as per the following: -

#### **PRIMARY DATA**

Essential information is the establishment of this examination. Following procedure will took on to gather the fundamental data to investigate and give the exact outcomes,

##### **1. Polls.**

With the assistance of these Questionnaires information will gather and measure through factual techniques.

## SECONDARY DATA

Auxiliary information is likewise one of the establishments of this investigation. The specialist will gather auxiliary information from the distribute sources, for example:

1. Yearly report of Real Estate Companies.
2. Government gives an account of Real Estate.
3. Magazines on Real Estate area.
4. Utilization of web and so forth

## TOOLS EMPLOYED

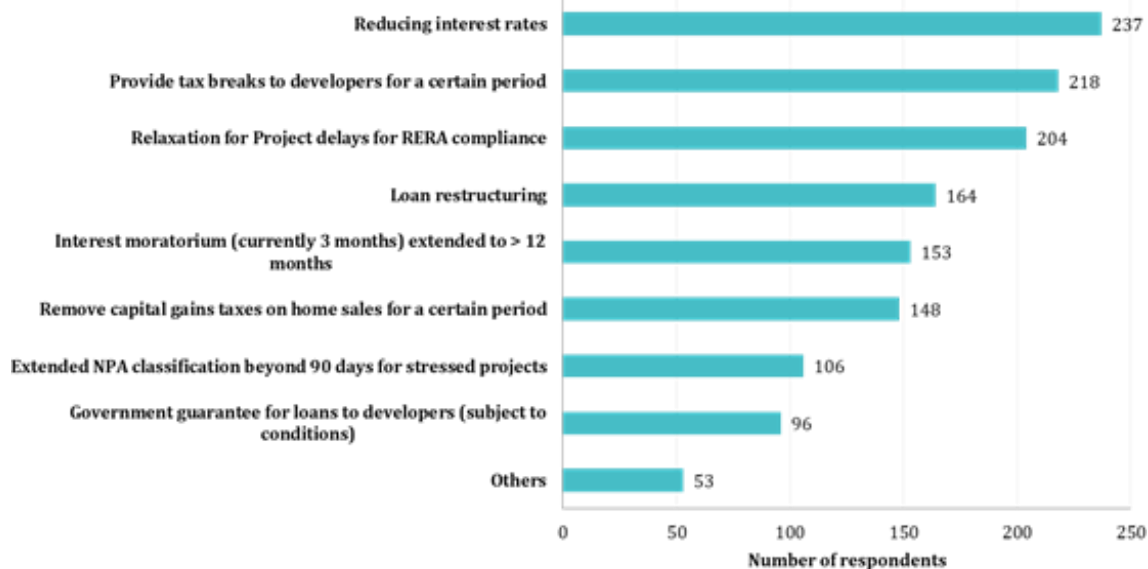
Different factual instruments will utilize, for example, Tables, pie diagrams, histograms and construction will utilize in clarifications to draw out the point all the more unmistakably. Accordingly considering this, while introducing contentions in principle, diagrammatic, primary, realistic portrayal will sort on some vital cases shows will provide for draw, made estimation of rate, positions and method for examination.

## LIMITATIONS OF STUDY

Despite the fact that its accomplishment, this exploration has a few constraints that ought to be tended to in future investigations. The first is the set number of specialists and respondents include in the investigation. The second impediment it is restricted for a very long time period for example 2002 to 2012. Another limit it is restricted to the given targets by the specialist.

## DATA ANALYSIS AND INTERPRETATION:

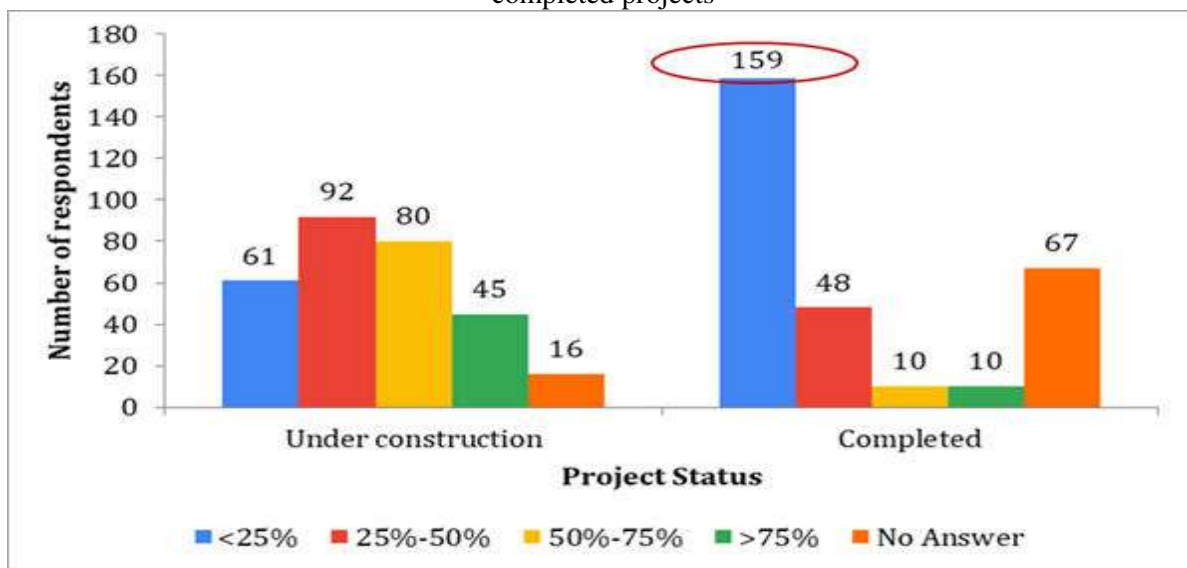
**Figure 1:** Government intervention expected by real estate developers in response to COVID-19



Sources: Secondary data collection

The public authority on its part has given a gigantic help bundle to support the economy post the lockdown. The public authority's alleviation measures for the land area reported between April 2020 to August 2020 can be assembled under three significant heads: Increment liquidity in the framework: Steps, for example, bringing down financing costs, implantation of INR 15,000 crores in NHB (in two tranches) to further develop long haul subsidizing prerequisites of NBFCs and HFCs, ban on all term advances for a time of a half year and the new declaration of a one-time advance rebuilding. Consistence under RERA and IBC: summoning power majeure proviso under RERA and expanding project enlistment and consummation courses of events by a half year for all activities enrolled under RERA. Expanding edge limit for Insolvency procedures for INR 1 L to INR 1 crore. Decrease in expenses to support lodging interest: Reduction in stamp obligation on reasonable lodging projects by states like Karnataka (stamp obligation scaled down from 5% to 3% for properties esteemed under INR 35L and to 2% on properties esteemed not as much as INR 20L) and Maharashtra (stamp obligation discounted from 5%-2% between September-December 2020 and to 3% from January to March 2021 in metropolitan regions across value portions), decrease in TDS on special of property by 25% and expansion for documenting GST and Income Tax.

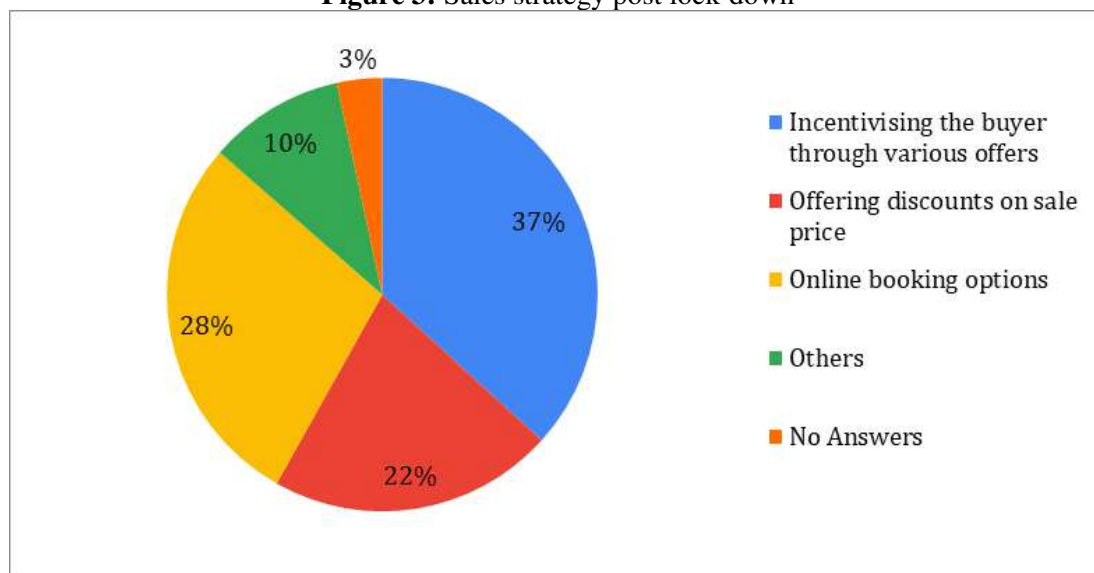
**Figure 2:** Distribution of respondents based on percentage of unsold inventory in under-construction and completed projects



**Sources:** Secondary data collection

As indicated by our overview, 54% of the respondents had 25% or less unsold stock in their finished undertakings, at the end of the day prepared to move in properties. The focal point of these designers will be on deals of this stock to help work on their sources of income. To accomplish this, valuing is either going to be steady or at a limited cost as on account of a couple of engineers who are under serious liquidity stress. As indicated by our overview, 22% of the study respondents had thought about a decrease in cost. Be that as it may, value decrease has its own difficulties for both the purchasers and venders as far as tax assessment.

**Figure 3:** Sales strategy post lock-down

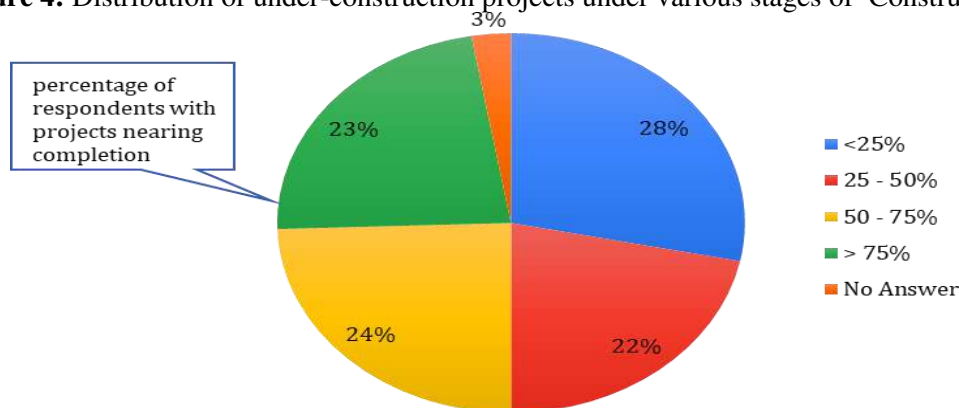


**Sources:** Secondary data collection

The third significant concern is to back development of continuous undertakings. Once rebuilding of credits for corporates and people, a new advance taken by RBI (in August 2020), is relied upon to give truly necessary relief to the land area. On the stockpile side it will help designers affected by COVID rebuild their current credits with a long-term ban without ordering these advances as Non-Performing Assets (NPAs). This will help private engineers raise last mile financing for their tasks adhered because of COVID-19. On the interest side, rebuilding individual home credits will help purchasers who are affected by employment cutback and pay slices to deal with their EMIs. In any case, crisp loaning to the area from Banks and Non-Banking Finance Companies (NBFC) will stay repressed as their emphasis will be on rebuilding of existing advances.



**Figure 4:** Distribution of under-construction projects under various stages of Construction



**Sources:** Secondary data collection

Without assets from Banks and NBFCs, engineers will turn towards PE reserves. In spite of the fact that PE subsidizing in the land area has decreased fundamentally in the primary portion of 2020, it is relied upon to recuperate in the coming a very long time as these assets have adequate dry-powder to contribute, yet are holding back to comprehend the full effect of this pandemic on resource valuations. While most PE assets might zero in on resources, for example, server farms and distribution centres, in the private fragment PE reserves are relied upon to choose projects that are approaching finishing because of their generally safe profile. As per our overview, 23% of the respondents had projects that were approaching fulfilment (over 75% complete). Elective banks, for example, Private Debt Funds and Special Situation Funds will be dynamic during the following a year.

At last, the following 12-year and a half are likewise liable to observe a second round of combination (a first round of union had begun because of strategy changes like RERA and GST and the NBFC emergency), where exceptionally utilized, little to medium sized designers with enormous unsold stock, helpless execution capacities, and above all, neglected to put resources into innovation are probably going to exchange their resources at upset valuations. IIMB RERI will direct a second round of this overview in September 2020 to comprehend the effect of these strategy measures on the area.

## CONCLUSION

Urban communities assume three significant parts. They are spots of creation, spots of utilization and spots to live. These contending requests make rivalry for how space is utilized. This is especially the situation in downtown areas, where the advantages of nearness have prompted a blast in both downtown areas working and living in spots like Manchester and Leeds as of late. For strategy producers, this metropolitan restoration implies that inexorably decisions and compromises must be made over how to distribute space in these focuses.

In settling on these choices comprehend the connections between the various jobs that urban communities play. The development of occupations in numerous downtown areas has been driven by the longing of higher-gifted, administration based businesses to be situated in thick downtown areas. Thusly, by both giving better admittance to occupations and driving up interest for conveniences, like shops and cafés, this development in positions has started a restoration in downtown area living in effective downtown areas. Yet, this accompanies a danger – give an excess of land over to private space and land for business space becomes crushed, with suggestions for the capacity of a downtown area economy to proceed to develop and make occupations later on. Thus, this has suggestions for usefulness, wages and thriving. Right now public arrangement chances crushing the business heart of urban areas. The National Planning Policy Framework and strategies, for example, allowed improvement rights appropriately centre on handling lodging deficiencies. PDR, specifically, has assumed a significant part in conveying new houses in specific pieces of the nation, changing over neglected business space into private use, and has permitted the market to direct these choices. In any case, it does this by changing business space over to private, instead of empowering new homes to be constructed. It will likewise be critical that approach keeps on supporting the job of urban communities as spots to live. This will require both structures up and out in our best urban areas. At present various strategies, like preservation regions, London's secured sees and the green belt limit this, crushing the measure of new space accessible and stirring up rivalry between various land employments. An unwinding of these principles at the neighbourhood and public level that permits densification inside urban areas and key improvement of the greenbelt is required assuming we need to both stock the homes we need and facilitate the tension on business space in the focuses of urban communities.

---

---

**BIBLIOGRAPHY**

- 1) Prof. Jayshri J Kadam Prof. Dr. V.N. Laturkar, A study of Financial Management in Small Scale Industries in India. International journal of exclusive management of research. August 2011 ISSN 2249 – 2585.
- 2) Bhavsar, S. and Kalam, P, A study of enterpreneship development in small scale industries with special reference to beed district in Maharashtra India. Journal of Arts, Science & Commerce (2012). ISSN 2231-4172.
- 3) Jain, Vipul. And Jain, Arvind ,A Study and scope of SME’S in Uttrakhand and problems faced by them.Asian Journal of Business and Economics, (2012) ISSN 2231-3699.
- 4) Kadam, R. financial management: the key strategy for the Sustained growth of small scale industries in India. International Journal of Research in Finance & Marketing (2012). ISSN 2231-5985.
- 5) Kalyan Kumar, N. And Gulghot, S. Micro, Small and Medium enterprises in the 21st century. ZENITH International Journal of Business Economics & Management Research. (2012). ISSN 2249 8826
- 6) Matarneh, B. Working Capital Management of Small Scale Industries in Rajasthan. International Journal of Financial Research. (2012)ISSN 1923-4023.
- 7) Selvarajan, B. and Vadivalagan, G. A Study on Management of Non Performing Assets in Priority Sector reference to Indian Bank and Public Sector Banks (PSBs). Global Journal of Management and Business Research (2012) ISSN 0975-5853.

## **A Study on Skill Required For Commerce Graduates – A Key of Transformation in Commerce & Management for Economic Development and Sustainability**

**Manisha N. Ajara<sup>1</sup> and Ashok S. Luhar<sup>2</sup>**

<sup>1</sup>D.T.S.S. College of Commerce, Mumbai, India

<sup>2</sup>Anandibai Damodar Kale Degree College of Commerce, Mumbai, India

### **ABSTRACT**

**Background:** In the past year, the COVID-19 pandemic has quickly and dramatically accelerated the need for new workforce skills. The rapid rise of digitization and remote work has placed new demands on employees who, in many instances, now require different skills to support significant changes to how work gets done and to the business priorities their companies are setting. Also skilled commerce employees are required to bring transformation in commerce & management for economic development and sustainability because skill employees are one of the essential factors that impacts the growth of the business.

**Methods:** Primary Data has collected from 121 recruiters working as HR of different companies and HR consultancy firm based in Mumbai. The research has used convenient sampling technique for the data collection. The secondary data has been collected from various literature published in journals and thesis.

**Findings:** There is significant difference between skills acquired by commerce graduates and employers' expectation.

**Interpretation:** From the present study it can interpreted that, due to pandemic there is an increase in technology, digitalization and professionalism, companies and their business is changing in the fastest way. Due to COVID-19 Pandemic businesses are adopting digitalization. In present scenario business needs techno savvy employees to cope up with this digital age and helps businesses to achieve its sustainability goals during pandemic

**Keywords:** Commerce Graduates, Skill Gap, COVID-19 Pandemic, Economic Development and Sustainability

### **INTRODUCTION**

High level competition, especially among the frontline workforce, has contributed to the growth and development of skill competition. The skill needed to be successful in today's designing industry has changed over a period of time and have an impact not only on the profession but also on workforce in the designing industry. Although the organization provides education and training, still there is large gap that is detrimental to the growth of organization Skill gap describes the situation in which workers skills are incompetent for doing the job. There is a lack of interest in employees as well as employer in assessing the skill gap. Skill gap has the potential to lower the company's productivity level and increase the company cost. In addition, the skill gap can reduce the company's profit level and have an adverse effect on the company's sustainability. So, finding new ways to enhance employee's performance is very important for the organization, so that they can use the resources effectively and efficiently. Measuring expected skills and employees' ability to perform the job are therefore very important to improve performance in order to achieve objectives of the company

### **REVIEW OF LITERATURE**

Today's complex economy, organizations are finding difficult to sustain the competition because of huge skill gap in the workforce. Since analysis of skill gap provide crucial information of the employees so that the managers can focus on necessary skills that are required to enhance performance. The purpose of the study was to assess the skill gap and to know the relationship between skills and performance of the employees in designing industry. The research concluded that, considered skill will impact employee performance except technical skills inferring implication of technical skill is minimal in improving performance of company. Organization should therefore take necessary initiation to improve skill of the employees required in the workplace (Manjunath Shivaramu & M B Shraavan Murthy (2019). According to economic theory, skill mismatch is used to describe the gap between labor supply and demand (Bound & Holzer, 2006). Many economists used the word skill mismatch to describe the unemployment situation, in which jobs are available but cannot be filled due to lack of skills (Green 2011). In neo-classical economics, skill is one of the main ingredients in human capital, while wealth is other. Human capital can be viewed as the discounted value of current and future earnings of the person from individual point of view (Becker 1964, Mincer 1974). Trainings are provided to increase human capital of organization. Training and development are therefore investments in skills to be used in uncertain period of time (Bhattacharya & Wright, 2005). The major

limiting factor of neoclassical economics: The use of skills in the organization is limited by the extension of relationship with organization quality and culture (Hashmito 2010, Stevens, 1999 and 2002, Acemoglu & Pischke, 2002). The concept of skill in sociology looks skill concept from employee and employer frame work i.e. within the production process with main focus on the complexity of the activities which are bundled into job (Attewell, 1990). In order to perform these complex tasks, greater learning and high rewards are needed. The important contribution of sociology to understand the concept of skills is skill can be socially constructed during the process of performing complex activities ( Attewell, 1990, Wajcman, 1991, Stearns & Cockburn, 2006). The concept of skill in psychology has come from a long way since it is part of inherent learning. The skill is defined as a complex ability to reinforce positive rate (Libet & Lewinsohn, 1973) and social accepted behavior that make the person interact with the others. From the literature the definition of skills revolves around the communication and interaction with others. But the modern concept of skill in psychology defined as the ability to successfully perform a variety of tasks at a high level of performance. Skill gap: The American society for training and Development (ASTD) defines skill gap as gap between the current capability of organization and skills it needs to achieve its goal. So it can be referred as perceived mismatch between employer's skill need and the available workforce's skill. Some people often refer to the skill gap as a compensation gap where employers are not willing to pay sufficiently to bring in the skill required. Others call it a training gap where employers do not provide necessary training or the gap in the education and the employers need (EMSI 2013). The skill gap in the organization can be defined as the gap which does not allow to grow or to remain competitive as it is unable to find employees with right knowledge to fit into the critical job. Thus the performance of the company will be hampered by skill gap due to low productivity and lack of quality. (Bennett & McGuinness, 2009) It is therefore necessary to identify the skills in the workplace of the company rather than to identify gap in the workforce prior to selection due to difficulties in recruiting skilled labor despite paying high salaries. Quietly often, the company tends to hire incompetent workers not due to lack of skill availability but due to the selection process. Also reiterated in recent exploration (Andrew Weaver 2013) that it is not the skill shortage creates problem, it is the mechanism and suggested that instead of focusing on external skill labor supply, it is better to focus on the factors that make job process complicated.

## OBJECTIVE OF THE STUDY

1. To understand technical gap amongst commerce graduates

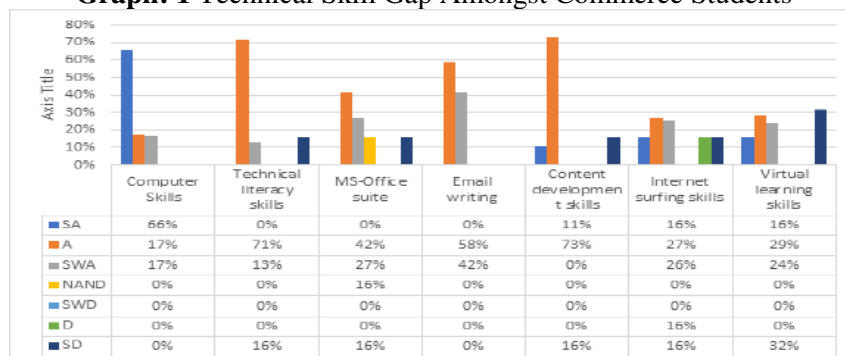
## DATA ANALYSIS AND INTERPRETATION

**Table: 1 TECHNICAL SKILL GAP AMONGST COMMERCE STUDENTS**

Skills	SA	A	SWA	NAND	SWD	D	SD	TOTAL
<b>Computer Skills</b>	80	21	20	0	0	0	0	<b>121</b>
<b>Technical literacy skills</b>	0	86	16	0	0	0	19	<b>121</b>
<b>MS-Office suite</b>	0	50	32	19	0	0	19	<b>121</b>
<b>Email writing</b>	0	71	50	0	0	0	0	<b>121</b>
<b>Content development skills</b>	13	89	0	0	0	0	19	<b>121</b>
<b>Internet surfing skills</b>	19	32	31	0	0	19	19	<b>121</b>
<b>Virtual learning skills</b>	19	35	29	0	0	0	38	<b>121</b>

Source: Primary Data collected by Researcher

**Graph: 1 Technical Skill Gap Amongst Commerce Students**



The above table and graph reveal that,

- 80 (66%) recruiters strongly agree, 21 (17%) agree and 20 (17%) recruiters somewhat agree with the computer skills amongst commerce graduates.

- 86 (71%) recruiters agree, 16 (13%) recruiters somewhat agree and 19 (16%) recruiters strongly disagree with the technical literacy skills amongst commerce graduates.
- 86 (71%) recruiters agree, 16 (13%) recruiters somewhat agree and 19 (16%) recruiters strongly disagree with the technical literacy skills amongst commerce graduates.
- 50 (42%) recruiters agree, 32 (27%) recruiters somewhat agree, 19 (16%) recruiters neither agree nor disagree and 19 (16%) recruiters strongly disagree with the MS-Office Suite skills amongst commerce graduates.
- 71 (58%) recruiters agree and 50 (42%) recruiters somewhat agree with the Email writing skills amongst commerce graduates.
- 13 (11%) recruiters strongly agree, 89 (73%) recruiters agree and 18 (16%) recruiters strongly disagree with the content development skills amongst commerce graduates.
- 19 (16%) recruiters strongly agree, 32 (27%) recruiters agree, 31 (26%) recruiters somewhat agree, 19(16%) recruiters disagree and 19 (16%) recruiters strongly disagree with the internet surfing skills amongst commerce graduates
- 19 (16%) recruiters strongly agree, 35 (29%) recruiters agree, 29 (24%) recruiters somewhat agree and 38 (32%) recruiters strongly disagree with the virtual learning skills amongst commerce graduates

### **FINDINGS**

The findings based on primary data is as follow as:

- 80 (66%) recruiters strongly agree with the computer skills amongst commerce graduates.
- 86 (71%) recruiters agree with the technical literacy skills amongst commerce graduates.
- 86 (71%) recruiters agree with the technical literacy skills amongst commerce graduates.
- 50 (42%) recruiters agree with the MS-Office Suite skills amongst commerce graduates.
- 71 (58%) recruiters agree with the Email writing skills amongst commerce graduates.
- 89 (73%) recruiters agree with the content development skills amongst commerce graduates.
- 32 (27%) recruiters agree with the internet surfing skills amongst commerce graduates
- 38 (32%) recruiters strongly disagree with the virtual learning skills amongst commerce graduates

### **REFERENCES**

1. Nghia, T. L., Giang, H. T., & Quyen, V. P. (2019). At-home international education in Vietnamese universities: Impact on graduates' employability and career prospects. *Higher Education*, 78(5), 817–834. <https://doi.org/10.1007/s10734-019-00372-w>
2. Anjum, S. (2020). Impact of internship programs on professional and personal development of Business Students: A case study from Pakistan. *Future Business Journal*, 6(1). <https://doi.org/10.1186/s43093-019-0007-3>
3. Kindo, M., & Astalin, P. K. (2020). A Study of Career Awareness of Tribal And Non-Tribal Students of Gumla District Jharkhand. *Internationaljournal Of Multidisciplinaryeducationalresearch*, 12(6), 73–76. <https://doi.org/2277-7881>
4. Ahmed, I., Nawaz, M. M., Ahmad, Z., Shaukat, M. Z., Usman, A., Wasim-ul-Rehman, & Ahmed, N. (2010). Determinants of students' entrepreneurial career intentions: Evidence from business graduates. *European Journal of Social Sciences*, 15(2), 14–22.
5. Sowmya, K. R., & Panchanatham, N. (2011). Factors influencing job satisfaction of banking sector employees in Chennai, India. *Journal of Law and Conflict Resolution*, 3(5), 76-79.
6. Bodra, S. R. (2012). The Career Options and Economic Status of Indian Educated Women in Era of Globalization (Unpublished PhD. thesis). Chhatrapati Sahuji Maharaj University, Kanpur, Uttar Pradesh, India
7. Gadhave, T. B., & Pai, V. A. (2013). Prospects and opportunities in the retail sector. *International Journals of Marketing and Technology*, 2(8), 91-100.

## Assessment of Surface Gamma Radiation and Water Quality Parameters with Special Focus on Uranium and Fluoride in Ground Water: A Case Study of Baran District, Rajasthan, India

R. Meena<sup>1</sup>, K. Parashar<sup>2</sup>, S. K. Sharma<sup>3</sup>, S. N. Tiwari<sup>4</sup>, S. K. Sahoo<sup>5</sup> and A. Rani<sup>6</sup>

<sup>1</sup>Department of Chemistry, Govt. College Kota, Rajasthan, India

<sup>2,3,6</sup>Department of Pure and Applied Chemistry, University of Kota, Rajasthan, India

<sup>4</sup>ESL, Rajasthan Atomic Power Station, Rawatbhata, Rajasthan, India

<sup>5</sup>Health Physics Division, Bhabha Atomic Research Centre, Mumbai, India

### ABSTRACT

Uranium concentration was assessed in water samples collected from hand pumps, tube wells and open wells selected through grid mapping of different tehsils viz. Anta, Baran, Kishanganj, Shabad, Atru, Chabra, Mangrol, Chhipabarod in Baran districts of Rajasthan, India. Systematic sampling grid map based on a distance of approximately 50 kilometers was prepared and approximately 200 samples were collected from the study area during pre and post monsoon seasons. The estimation of uranium was done by using LED fluorimeter. Along with uranium, other associated physico-chemical parameters of water such as pH, electrical conductivity, temperature, total alkalinity, phenolphthalein alkalinity, total hardness, magnesium hardness, Calcium hardness, Chloride, Fluoride, Sulphate, Phosphate, Nitrate, Total Dissolved Solids (TDS) and Oxidation Reduction Potentials (ORP) were also determined using standard Bhabha Atomic Research Centre (BARC) Protocols<sup>(1)</sup>. Statistical tools were applied to analyze the analytical data and its spatial distribution. The study is helpful in identifying the uranium mapping of the district. The analytical data for all water parameters and uranium were cross checked with respect to recommendations given by BIS/WHO limits to identify the pollution level. An attempt has been made to correlate uranium concentration with these water quality parameters. A positive correlation of electrical conductivity, fluoride, nitrate, TDS, sulphate, carbonate, bicarbonate, total alkalinity, total hardness, calcium and magnesium hardness with uranium concentration has been observed. However, negative correlation of uranium concentration with pH, salinity, chloride, phosphate, ORP was observed. The uranium concentration in water samples is found to vary from 0.5 ppb to 16.5 ppb in pre monsoon with a mean value of 3.722 ppb and 0.6 ppb to 19.1 ppb in post monsoon with a mean value of 5.048 ppb.

Keywords: Ground Water, Fluoride, LED Fluorimeter, Baran district, Uranium, Physico-chemical parameters

### INTRODUCTION

Water a symbol of life and most crucial natural resource sustaining life on earth. It is also most important for the socio-economic development of any country. The demand of water for drinking and domestic purposes, livestock, agriculture, industries, power generation and other uses are all increasing with growth of population and industrialization. The demand for potable water is continuously rising in the state for irrigation needs arising due to lack of rains and water scarcity. The average annual per capita water availability in the years 2001 and 2011 was assessed as 1816 cubic meters and 1545 cubic meters respectively in Rajasthan which further reduced to 1486 cubic meters in the year 2021 and expected to be 1367 cubic meters in year 2031<sup>(2)</sup> due to prevailing high growth rate of population the per capita water availability is declining to alarmingly low levels, implying that the challenges for the water sector in the Rajasthan state of India are great. Groundwater plays a major role in supplying water for drinking, agricultural, and industrial uses<sup>(3-5)</sup>. Over-extraction of water from aquifers is one of the major causes that lead to increase in concentration of ionic moieties in groundwater (Kadam et al.2020)<sup>(6)</sup>. Uranium is a widely known actinide, radioactive, lithophilic and naturally occurring heavy trace element found mostly in igneous rocks, soils, granites and earth crust<sup>(7)</sup>. It may naturally be present in rocks, soil, air, and water affecting human kidneys and lungs on exposure<sup>(8-9)</sup>. The concentration of uranium in groundwater depends on the lithology, geomorphology, and other geological conditions of the region<sup>(10-11)</sup>. Natural uranium is a mixture of three isotopes which includes <sup>234</sup>U, <sup>235</sup>U and <sup>238</sup>U. Uranium occurs in various oxidation states, but tetravalent and hexavalent are the most dominant states of uranium. The hexavalent state is especially important in water due to its solubility whereas the tetravalent state is almost insoluble in water. The hexavalent form of uranium is commonly established to be in the form of uranyl ion  $UO_2^{2+}$ . Uranium intake through water and air is low. Drinking water with uranium content above 30  $\mu\text{g/L}$ <sup>(12)</sup> is not suggested for drinking purposes as on regular intake due to the damage to internal organs like kidney<sup>(13-14)</sup> and bones<sup>(15)</sup>. The concentration of uranium in groundwater depends on multiple parameters such as pH, ORP, EC, TDS, anionic ligands etc. The mechanism of leaching of uranium from host rock to groundwater is a complex process and

may depends on factors like contact time, temperature, rock characteristic and elemental geochemistry. Other physico-chemical parameters of water such as ORP, electrical conductivity, DO, TDS, Total-hardness, Ca-hardness, Mg-hardness, salinity, temperature etc are essential to know to provide important firsthand information about how much the water is suitable for drinking purposes<sup>(16)</sup>. The pH is a measurements of the level of alkali or acid in a substance monitored to assess aquatic environment and human health, drinking water sources and discharges of the industries. Total dissolved solids (TDS) are the small amounts of organic matter and inorganic salts solvated in water. Anions such as fluoride, nitrate, sulphate also play a vital part in determining the quality of drinking water. The high amount of sulphate can cause diarrhea and intestinal disorders<sup>(17)</sup>. The blue baby disease or methemoglobinemia is reported to cause by nitrate content of more than 45 mg/L<sup>(18)</sup>. The dental skeletal fluorosis diseases can be caused by intake of fluoride concentration of 3 mg/L or more<sup>(19)</sup>. Therefore, the aim of this study is to investigate the quality of the groundwater by analyzing water quality parameters with special focus to uranium concentration in groundwater of Baran district of Rajasthan, India. The study will be helpful in determining whether the water of baran district of Rajasthan can be used for drinking purposes without posing any health hazard to the inhabitants. The groundwater investigations were carried out by GSI in 1969-70 and systematic hydro geological Survey has been carried out by Central Ground Water Board, Western Region (CGWB, WR), Jaipur in 1980-81. Groundwater exploration was also undertaken in the year 1983-85. Later other hydro geological activities have been undertaken by CGWB, WR, Jaipur for groundwater evaluation and resources estimation in association with the ground water department of Rajasthan State. Monitoring of National hydrographic stations four times in a year is done by Central Ground Water Board, Western Region, Jaipur. A total of seven exploratory wells have been drilled in Baran district. The depth of exploratory wells varies from 25.5 to 175 m and static water level varies from 2.88 to 32.2 m. The transmissivity of the aquifers varies from 78 to 403 m<sup>2</sup> /day and discharge of the wells varies from 72 to 550 liters per minute (lpm)<sup>(20)</sup>. However literature survey shows no attempt has been made towards the measurement of uranium concentration and water quality parameters in groundwater in selected sampling sites of Baran district of Rajasthan, India in the recent past.

## MATERIALS AND METHODS

### Study Area

The study area is one of the major district of Rajasthan named baran district with an area of 6992 sq km , located between latitude 24°25'00" and 25°27'00" east and longitude 76°12'00" and 77°25'00" north. The district forms a part of Kota Division. It is bounded by Kota district in the west and Madhya Pradesh in the northeast and in south by Jhalawar district. It falls on Survey of India top sheet numbers 54C, 54D, 54G & 54H (on 1:2, 50,000 scale). Administratively, the district is divided into eight tehsils and six development blocks. The district has eight tehsils naming as Anta, Baran, Kishanganj, Shabad, Atru, Chabra, Mangrol and Chhipabarod. Fig.1 shows the study map of Baran district of Rajasthan, India



Fig.1 the study map of Baran district of Rajasthan, India

Total number of inhabited villages in the district is 1114 with 4 urban towns including 6 sub urban townships. Total population of Baran district in 2021 is reported 1,372,957 as per Govt. records <sup>(20)</sup>. Baran district falls under the arid to a semi-arid type of climatic zone according to the meteorological classification given by India Meteorological Department. The normal annual rainfall for the Baran district for the period 2020 is 560 mm and 2021 is 1064.5 mm. The maximum temperature during summer rises as high as 48°C while the minimum during winter reaches as low as 5°C. The summer season prevails from March to mid of June after which the rainy season starts with the onset of monsoon rains lasting till the end of September. The potential evapotranspiration is 1780.0 mm annually <sup>(21)</sup>. The district is a part of the “Hadoti Region”, which is a distinct geomorphic region of Rajasthan state. The hill ranges of the Vindhyan in the northeast and low rounded hills of Malwa plateau in the southbound region, while sedimentary rocks belonging to the Vindhyan supergroup occupy the northwestern part. The rivers and the streams of the district belong to the Chambal river system. The rivers drain through an undulating plain that slopes from SSE to NNW. It attains a maximum height of 500m at village Rajpur and a minimum of 220 m above mean sea level at village Ulthi. During the present study in Baran district total 200 ground water samples were collected during pre-monsoon and post-monsoon seasons. The study area of Baran district was divided into optimize grid size of 6 x 6 using latitude-longitudes reference coordinates. Ground water/Drinking water samples were collected in pre-acid cleaned polypropylene bottles with proper labels having details of location (State, Districts, Taluka, Village, Source of the sample, GPS coordinate, Date of sampling, etc) for analysis in both pre-monsoon and post-monsoon. Garmin GPS eTrex was used to locate the sampling sites.

#### **Estimation of Uranium in ground water samples**

Uranium analysis was done in LED fluorimeter LF-2 (Quantalase Enterprises Pvt. Ltd., India). The fluorimeter is calibrated with four uranium standards to check the instrument performance and the linear dynamic range. One uranium standard of 500 ppb is prepared; each time 50 micro liter is added to 5 ml ultrapure water and 0.5 ml buffer, to avoid the error in the preparation of lower ppb level standards. Also, the ppb level standards are prepared fresh before analysis. When the TDS level was low (less than 1500ppm) in clear drinking water samples, then the water sample can be directly analyzed for uranium using a fluorimeter, no chemical processing is done. 5 ml of water sample was taken in a cleaned and dry suprasil quartz cuvette, added with 0.5 ml of buffer (fluorescence enhancing agent that is 5 % sodium pyrophosphate solution, pH is almost 7 adjusted using phosphoric acid). The fluorescence response of the sample is recorded, in terms of counts with minimum 4 repetitions. 50 micro liter of 500ppb uranium standard is added onto the cuvette that contains the sample and buffer, the fluorescence response of the first standard added (amount of standard additions depends on the sample fluorescence counts). Again 50 micro liters of 500ppb uranium standard is added onto the cuvette and fluorescence response is recorded. Uranium level in the sample is analyzed using standard addition method using excel sheet, to avoid matrix effect.

#### **Estimation of Physico-chemical parameters in ground water samples**

The measurements of TDS, EC (electrical conductivity), pH, temperature, salinity, DO, resistivity, were done using a in-situ using Easy cyberscan series 600 water proof portable meter and portable electrode sensors. Measurement of Nitrate, Chloride, fluoride was done using a Eutech Instruments Technology made Easy cyberscan series 600 water proof portable meter used portable electrode sensors. The measurements of Total hardness and Ca hardness are done by EDTA Complex metric titration method, Mg hardness by the difference between the values of Total hardness and Ca hardness. The measurements of total alkalinity were found by the H<sub>2</sub>SO<sub>4</sub> titration method using methyl orange as an indicator. The phosphate and sulphate concentrations were determined using UV-Visible Spectrophotometer. BARC, standard protocols are followed in the analysis of all the parameters <sup>(22)</sup>.

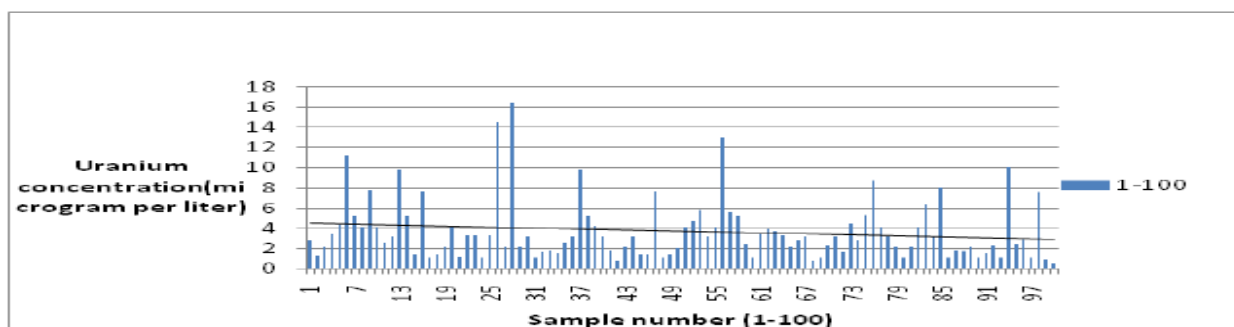
### **RESULTS AND DISCUSSION**

The analytical results of uranium and other parameters of 200 drinking water samples collected from different tehsils of study area are presented in **table 1** for pre-monsoon and post-monsoon samplings. Gamma radiation level at the sampling sites was found between 56 nSv/h to 123 nSv/h with a mean value of 87.93 nSv/h both in pre monsoon and post monsoon. There is no standard range prescribed for gamma radiation the cosmic radiation contributes to about 31 nSv/h in mean sea level <sup>(1)</sup>. pH value of groundwater/drinking water ranged from 6.98 to 8.65, with an average of pH is 7.53 in pre monsoon and 6.97 to 8.65, with an average of pH is 7.53 in post monsoon. The pH value of groundwater/drinking water is mainly affected by the soil composition and bedrock, organic materials. The TDS value was estimated to be 2.0ppm to maximum 2687ppm, with mean value of 897.91 in pre monsoon and minimum 1.0ppm to maximum 2888ppm, with mean value of 838.85 in post monsoon. TDS is found higher to BIS/WHO standards, due to the high concentration of Calcium and

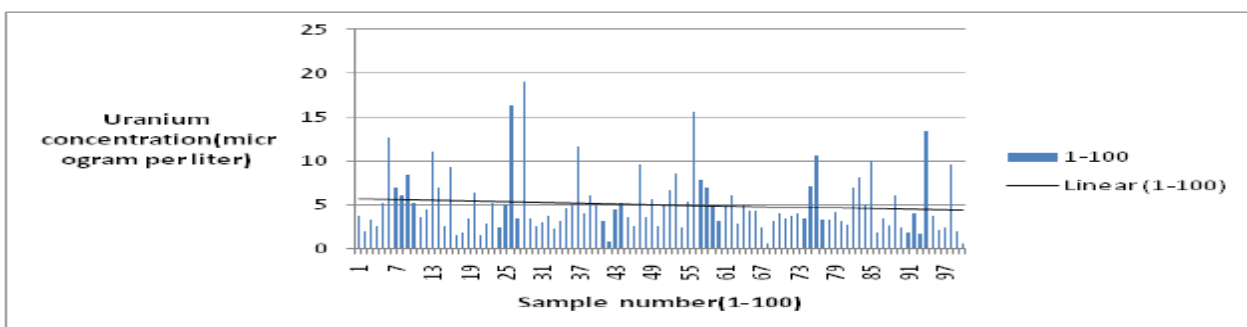


Magnesium in the rocks and soil of the area. The electrical conductivity of groundwater/drinking water of Baran district ranges between 2.0-2677  $\mu\text{S}/\text{cm}$ , with a mean of electrical conductivity of 891.13 in pre monsoon and from 1.0-2883  $\mu\text{S}/\text{cm}$ , with a mean of 838.85  $\mu\text{S}/\text{cm}$  in post monsoon. ORP values of analyzed water samples varied from 15.2 to 173.8mV, having mean value of 82.07 in pre-monsoon and ranged between 15.2 to 175.2mV, with mean of 81.22 in post-monsoon. The temperature value of water varies from 31.4-33.8 $^{\circ}\text{C}$  with an average temperature of 32.40 $^{\circ}\text{C}$  in pre monsoon and varies 19.2 to 22.5 $^{\circ}\text{C}$ , with an average of temperature of 20.72 $^{\circ}\text{C}$  in post monsoon. Salinity varies from 115-2456ppm, with mean of salinity of 522 in pre monsoon and 1.03-9102ppm, with mean of salinity 742.71ppm in post monsoon. Dissolved Oxygen (DO) varies from 3.26-8.13ppm, with mean of DO value is 6.06 in pre monsoon and 3.88-8.38ppm, with mean of is 6.62 in post monsoon. Fluoride in the region varies from 0.12-1.9ppm, having mean of 0.60ppm in pre monsoon while varies between 0.5-1.7ppm, with mean of fluoride is 0.73 in post monsoon seasons. According to WHO/BIS standards, the fluoride was established to be exceeding the permissible limits i.e. 1ppm in some areas only. Chloride varies from 8.1-1200ppm, with mean of chloride is 270.95ppm in pre monsoon and varies from with 24-1000ppm; with mean of 247 in post monsoon season. According to WHO/BIS standards, the chloride was established to be exceeding the permissible limits i.e. 250ppm in many samples probably due to the anthropogenic factors such as road salt, sewage contamination and water softeners etc. Nitrate in ground water varies from 9.1-365ppm, having mean as 99.64ppm in pre monsoon and varies 8-350ppm, with mean 108.24ppm in post monsoon samplings. Nitrate is also found to exceed the WHO permissible limits in many samples. The main cause for increase in nitrates may be due to the large number of well constructions, well location, overuse of chemical fertilizers, or improper disposal of human and animal waste. Total alkalinity value of water varies from 50-900 mg per liter, mean of total alkalinity is 422.3mg/l in pre monsoon and 50-890 mg per liter, mean of total alkalinity is 436.2mg/l in post monsoon. According to WHO/BIS standards, the Total alkalinity was found to be exceeding the permissible limits i.e. 200ppm. The main cause of increase in alkalinity may be due to a large number of dissolved phosphate, limestone and borates etc. The total hardness value of water varies from 96-980mg/l, mean of total hardness is 312.28mg/l in pre-monsoon and 80-970mg per liter, mean of total hardness is 291.65mg/l in post-monsoon. According to WHO/BIS standards, the Total hardness was found to be exceeding the permissible limits i.e. 200ppm. The reason for the increase in total hardness may be due to a large number of dissolved polyvalent metallic ions from sedimentary rocks, seepage and runoff from soils. Calcium and Magnesium, the two principal ions, are present in many sedimentary rocks, the most common being chalk and limestone. The calcium hardness value of water varies from 0.66-622 mg per liter, mean of Ca hardness is 192mg/l in pre monsoon and 40-650mg per liter, mean of Ca hardness is 180.81mg/l in post-monsoon. Mg hardness value of water varies from 0-440mg per litre, mean of Mg hardness is 119.62mg/l in pre-monsoon and 0-440 mg per litre, mean of Mg Hardness is 111.84mg/l in post-monsoon. The phosphate value of water varies from 0.12-0.98mg per litre, the mean of phosphate is 0.59mg/l in pre-monsoon and 0.23-0.96 mg per litre, mean of phosphate is 0.610mg/l in post monsoon. Sulphate value of water varies from 1.5-95mg per litre, mean of sulphate is 47.86mg/l in pre monsoon and 10-90 mg per litre, mean of salinity is 43.94mg/l in post monsoon. Carbonate value of water varies from 0-500 mg per litre, mean of carbonate is 156.8mg/l in pre monsoon and 0-400mg per litre, mean of carbonate is 134.7mg/l in post monsoon. Bicarbonate value of water varies from 0-890 mg per litre, mean of bicarbonate is 266.4mg/l in pre monsoon and 40-890 mg per litre, mean of bicarbonate is 301.5mg/l in post monsoon. Uranium value of water varies from 0.5-16.5ppb, mean of Uranium is 3.72ppb in pre monsoon and 0.6-19.1ppb, mean of Uranium is 5.04ppb in post monsoon. Summary of the results of Baran districts of Rajasthan is presented in table number 1 for both pre-monsoon and post-monsoon, respectively and for all the other water quality parameters i.e., pH, ORP, Salinity, Temperature, Dissolved Oxygen, Fluoride, Chloride, Nitrate, Sulphate, Phosphate, Uranium, Total Hardness, Ca Hardness, Mg Hardness, Phenolphthalein alkalinity, Total Alkalinity, Bicarbonate and Carbonate. Out of 200 water samples collected from Baran district of Rajasthan, present of samples exceeding the permissible limits are shown table 2. The Uranium concentration in ground water samples vary from 0.5 to 16.5 ppb in pre monsoon and 0.6 to 19.1 ppb in post monsoon in the study area. The average, median, mode, standard deviation(SD) of the drinking water/ground water samples is 3.7223ppb, 3.05ppb, 3.2 ppb, 3.0 in pre monsoon and 5.0484ppb, 4.1ppb, 5.1ppb, 3.39 in post monsoon. The minimum value is 0.5 (pre monsoon), 0.6 (post monsoon) and maximum value is 16.5 (pre monsoon), 19.1 (post monsoon) in Baran district of Rajasthan. Dobra village in chipabarod block has minimum value, 0.5 ppb in pre monsoon and 0.6 ppb in post monsoon. Raruti village in Baran block has maximum value 16.5 ppb in pre monsoon and 19.1 ppb in post monsoon in study area of Baran district. The Uranium level determined for all areas of Baran districts of Rajasthan was established to be within the permissible limit. The limits given by WHO is 30ppb and BIS is 60ppb. Percentage of samples exceeding/permissible limits of different parameters based on BIS, 2012 and WHO, 2011 are given

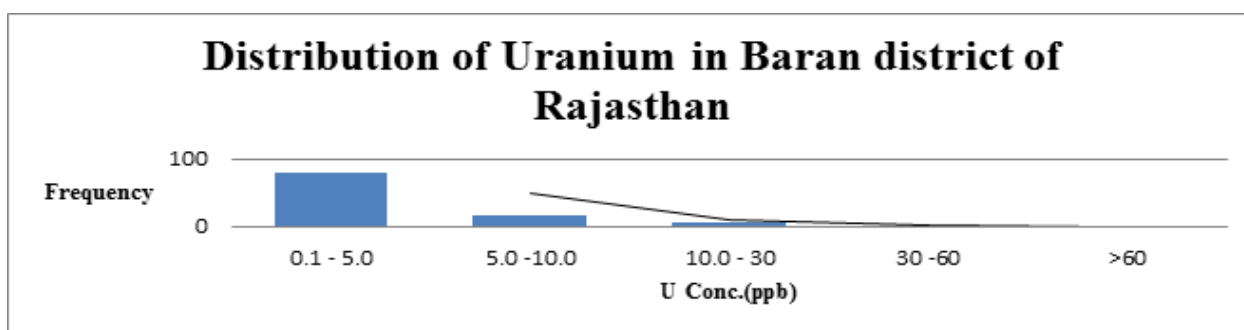
in the table 2, looking to the toxicity of U, F,  $\text{NO}_3^-$ ,  $\text{PO}_4^{3-}$ , it is desirable to include analytical data of these parameters analyzed at various sampling sites in the larger interest of the public. Table 3 gives results of ground water/drinking water samples analyzed at selected locations for gamma radiation level, U, F,  $\text{NO}_3^-$ , and  $\text{PO}_4^{3-}$  during pre and post-monsoon sampling. Table 4 to 5 correlation coefficients and the nature of correlation for uranium measurements with different physico-chemical parameters in drinking water samples in pre-monsoon and post-monsoon. Figure 2 and 3 explain the distribution of uranium in groundwater samples during pre monsoon and post monsoon in the study area, Figure 4 to 5 explain the frequency of uranium in groundwater samples during pre monsoon and post monsoon of Baran district. Figure 6 show to weak positive correlation plot (scatter plot) between Uranium concentration and Fluoride concentration in water samples of pre and post-monsoon, figure 7 to 9 show to weak positive correlation plot (scatter plot) between Uranium concentration and Total hardness, Calcium hardness, Magnesium hardness concentration in water samples of pre and post-monsoon.



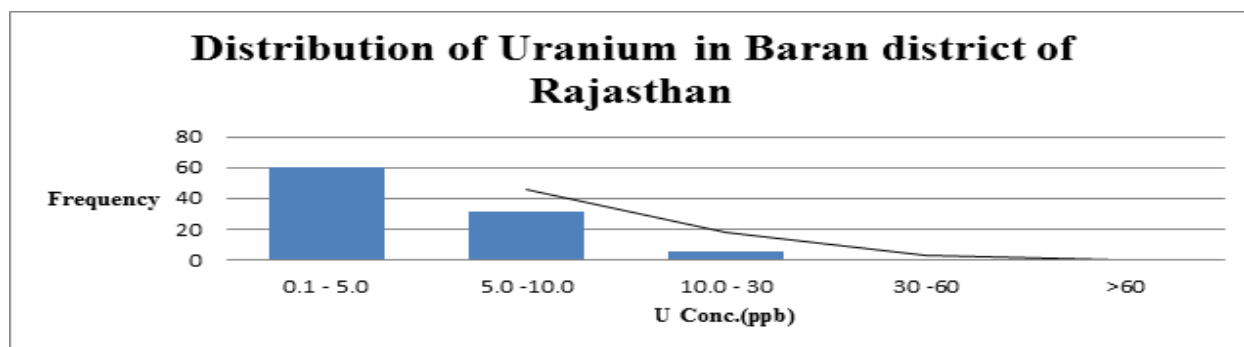
**Fig.2:** Distribution of uranium in groundwater samples during pre monsoon of baran district



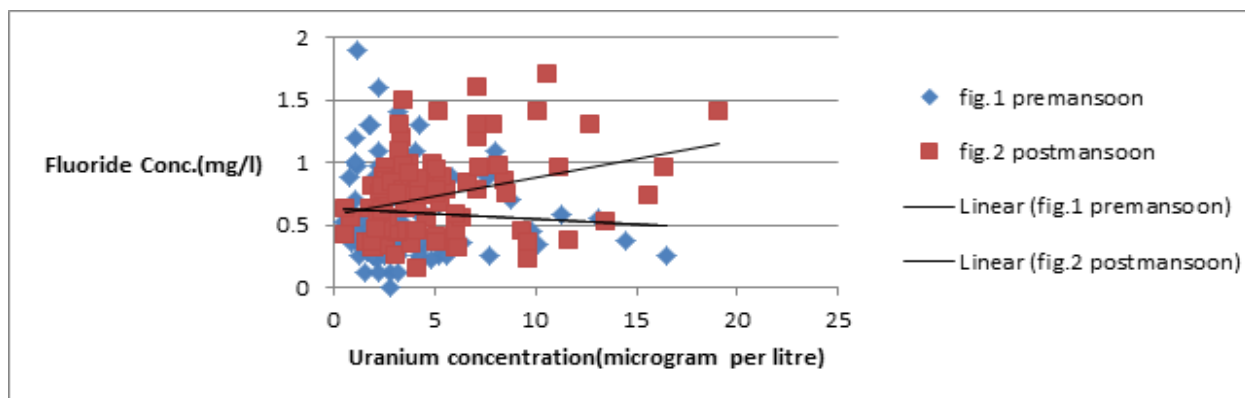
**Fig.3:** Distribution of uranium in groundwater samples during post monsoon of baran district



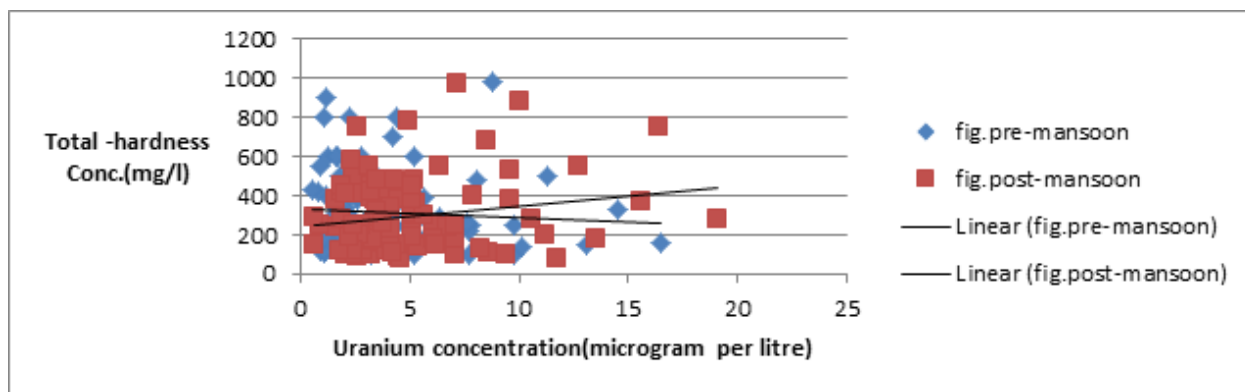
**Fig.4:** Frequency of uranium in groundwater samples during pre monsoon of baran district



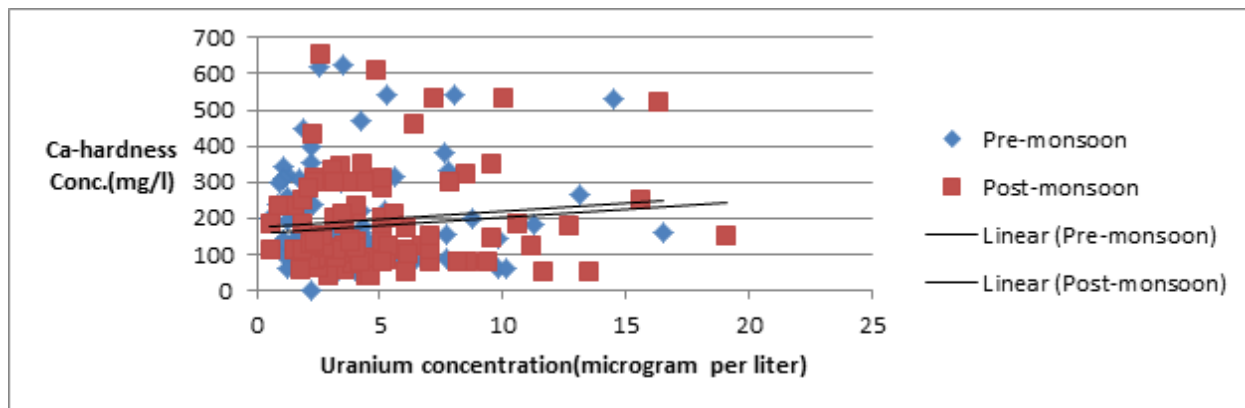
**Fig.5:** Frequency of uranium in groundwater samples during post monsoon of baran district



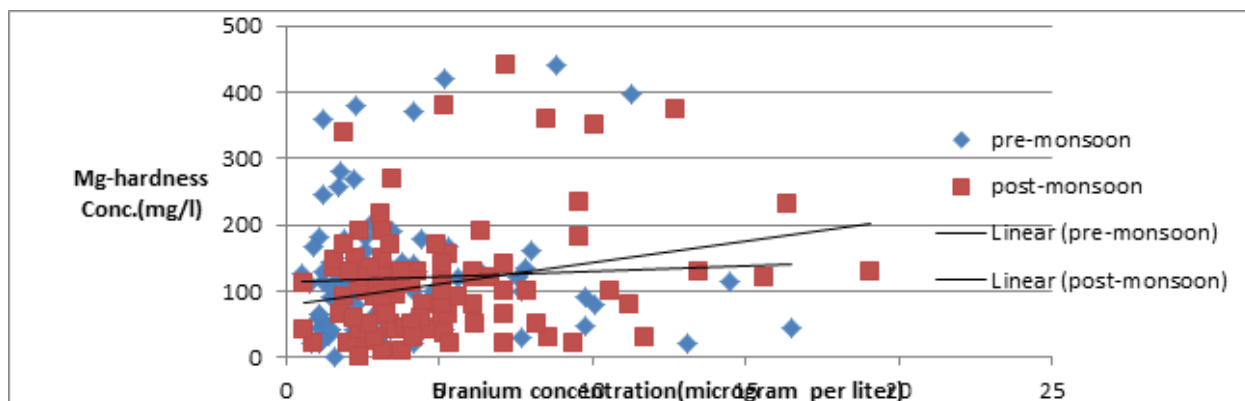
**Fig.6:** Correlation plot (scatter plot) between Uranium concentration and Fluoride concentration in water samples of both pre-monsoon and post-monsoon



**Fig.7:** Correlation plot (scatter plot) Uranium concentration and Total-hardness concentration in water samples of both pre-monsoon and post-monsoon



**Fig.8:** Correlation plot (scatter plot) between Uranium concentration and Ca-hardness concentration in water samples of both pre-monsoon and post-monsoon



**Fig.9:** Correlation plot (scatter plot) between Uranium concentration and Mg hardness concentration in water samples of both pre-monsoon and post-monsoon

**Table1:** Summary of Maximum, Minimum, Mean and Median of Uranium and Physicochemical water quality parameters in Baran District of Rajasthan, India (Pre monsoon and Post-Monsoon).

Parameter	Pre-monsoon				Post-monsoon				BIS/WHO limits
	Max	Min	Mean	Median	Max	Min	Mean	Median	
Gamma radiation level (nSv/h)	123	56	87.93	88	123	56	87.93	88	-
pH	8.65	6.98	7.59	7.55	8.65	6.97	7.53	7.48	6.5-8.5
TDS(ppm)	2687	2.013	897.91	825.3	2883	1.00	838.85	720.1	500
EC( $\mu$ s/cm)	2677	2.00	891.13	813.8	2749	2.0	832.85	706.45	750
ORP(mV)	173.8	15.2	82.07	85.10	175.2	15.2	81.22	84.15	720
Temperature	33.8	31.4	32.40	32.45	22.5	19.3	20.72	20.7	-
Salinity(ppm)	2456	115	522.01	452	9102	1.03	742.71	589.05	250
DO(ppm)	8.13	3.26	6.06	5.94	8.38	3.88	6.62	6.68	5.0
Fluoride(ppm)	1.9	0.12	0.60	0.49	1.7	0.15	0.732	0.75	1.0
Chloride(ppm)	1200	8.1	270.95	224.5	1000	24	247	210	250
Nitrate(ppm)	365	9.1	99.64	85	350	8	108.24	97.5	45
Total alkalinity(mg/l)	900	50	422.3	390	890	50	436.2	440	200
Total Hardness(mg/l)	980	96	312.28	260	970	80	291.65	250	200
Ca Hardness(mg/l)	622	0.66	192.01	140	650	40	180.81	130	75
Mg Hardness(mg/l)	440	0	119.62	108	440	0	11.84	100	30
Phosphate (mg/l)	0.98	0.12	0.59	0.64	0.96	0.23	0.610	0.59	0.3
Sulphate(mg/l)	95	15	47.86	37	90	10	43.94	35	200
Carbonate (mg/l)	500	0.0	156.8	128.98	400	0.0	134.7	120	-
Bicarbonate (mg/l)	890	0.0	266.4	215	890	40	301.5	300	-
Uranium(ppb)	16.5	0.5	3.72	3.05	19.1	0.6	5.04	4.1	60(AERB)/30ppb

**Table2.** Groundwater % samples exceeding desirable/ permissible limit for drinking purpose based on BIS, 2012 and WHO, 2011

Parameter	% Samples exceeding desirable limits (BIS,2012)	% Samples exceeding permissible limits (BIS,2012)	% Samples exceeding desirable limits (BIS,2012)	% Samples exceeding permissible limits (BIS,2012)	% Samples exceeding desirable limits (WHO, 2011)	% Samples exceeding permissible limits (WHO, 2011)	% Samples exceeding desirable limits (WHO, 2011)	% Samples exceeding permissible limits (WHO, 2011)
	Pre monsoon	Pre monsoon	Post monsoon	Post monsoon	Pre monsoon	Pre monsoon	Post monsoon	Post monsoon
pH	1.0%	1.0%	1.0%	1.0%	1.0%	0.0%	1.0%	0.0%

EC( $\mu$ S/cm)	59%	3%	43%	4%	29%	4%	23%	6%
Total hardness (mg/L)	59%	6%	56%	6%	35%	12%	35%	11%
TDS (mg/L)	81%	4%	72%	6%	75%	10%	71%	8%
Calcium ( $\text{Ca}^{+2}$ ) (mg/L)	66%	26%	68%	23%	66%	26%	68%	23%
Magnesium ( $\text{Mg}^{+2}$ ) (mg/L)	61%	34%	60%	34%	65%	17%	62%	17%
Chloride ( $\text{Cl}^-$ ) (mg/L)	42%	2%	39%	0.0%	47%	14%	45%	13%
Sulfate ( $\text{SO}_4^{-2}$ ) (mg/L)	0.0%	0.0%	0.0%	0.0%	0.0%	0.0%	0.0%	0.0%
Nitrate ( $\text{NO}_3^-$ ) (mg/L)	81%	81%	85%	85%	58%	28%	57%	32%
Fluoride ( $\text{F}^-$ ) (mg/L)	10%	2.0%	12%	1.0%	-	-	-	-
Total Alkalinity (mg/L)	89%	9%	89%	8%	-	-	-	-
DO (%)	87%	87%	87%	87%	-	-	-	-
U(ppb)	0.0%	0.0%	0.0%	0.0%	0.0%	0.0%	0.0%	0.0%
Phosphate(mg/l)	82%	82%	88%	88%	82%	82%	88%	88%
ORP (mV)	0.0%	0.0%	0.0%	0.0%	0.0%	0.0%	0.0%	0.0%
Salinity (ppm)	84%	84%	83%	83%	84%	84%	83%	83%

**Table3.** Ground water/Drinking water Samples analyzed for selected locations and their coordinates sampling sites and gamma radiation level, U, F<sup>-</sup>, NO<sub>3</sub><sup>-</sup>, PO<sub>4</sub><sup>3-</sup> concentration in the study area for pre and post-monsoon of Baran District ( A= Pre monsoon B= Post monsoon)

Sample / Village Name	Tehsil	GPS Coordinate (WGS 84, decimal)		Gamma radiation level (nSv/h)	U (ppb)	U (ppb)	F- (ppm)	F- (ppm)	NO <sub>3</sub> <sup>-</sup> (mg/l)	NO <sub>3</sub> <sup>-</sup> (mg/l)	PO <sub>4</sub> <sup>3-</sup> (mg/l)	PO <sub>4</sub> <sup>3-</sup> (mg/l)
		Latitude	Longitude		A	B	A	B	A	B	A	B
Palaytha	anta	N25 <sup>00</sup> 8.831'	E076 <sup>014</sup> .390'	93	2.8	3.8	0.98	0.99	88	80	0.53	0.56
Amalsara	anta	N25 <sup>00</sup> 6.334'	E076 <sup>014</sup> .141'	72	1.4	2.06	0.33	0.32	17	14	0.98	0.36
Dugari	anta	N25 <sup>00</sup> 7.305'	E076 <sup>016</sup> .246'	90	2.2	3.3	0.59	0.45	325	315	0.91	0.85

Bhajak heri	anta	N25 <sup>0</sup> 1.849'	E076 <sup>0</sup> 16 .193'	81	3.5	2.6	0.91	0.96	60	50	0.76	0.45
Antah	anta	N25 <sup>0</sup> 9.425'	E076 <sup>0</sup> 16 .971'	107	4.4	5.2	1.3	1.4	83	75	0.49	0.56
Bamuli ya	anta	N25 <sup>0</sup> 7.961'	E076 <sup>0</sup> 20 .613'	81	11.3	12.7	1	1.3	21	18	0.35	0.59
Bundi	anta	N25 <sup>0</sup> 8.114'	E076 <sup>0</sup> 23 .075'	93	5.2	7.1	0.77	0.78	147	140	0.42	0.75
Palaswa	anta	N25 <sup>0</sup> 9.299'	E076 <sup>0</sup> 22 .23'	99	4.2	6.1	0.58	0.45	125	110	0.83	0.26
Khajurna	anta	N25 <sup>0</sup> 9.099'	E076 <sup>0</sup> 23 .145'	106	7.8	8.5	0.81	0.86	135	100	0.76	0.3
Batavda	anta	N25 <sup>0</sup> 6.721'	E076 <sup>0</sup> 23 .796'	80	4.2	5.3	0.36	0.75	142	135	0.68	0.85
Borina	Baran	N25 <sup>0</sup> 4.838'	E076 <sup>0</sup> 23 .779'	86	2.6	3.6	0.67	0.63	35	30	0.35	0.75
Gajanjura	Baran	N25 <sup>0</sup> 6.423'	E076 <sup>0</sup> 27 .715'	98	3.2	4.5	0.45	0.85	155	150	0.84	0.59
Bengan i	Baran	N25 <sup>0</sup> 1.797'	E076 <sup>0</sup> 22 .865'	69	9.8	11.2	0.92	0.96	140	135	0.53	0.45
Sorsan	Baran	N25 <sup>0</sup> 0.793'	E076 <sup>0</sup> 18 .603'	82	5.2	7.1	1.9	1.6	125	120	0.95	0.26
Manpura	anta	N25 <sup>0</sup> 1.324'	E076 <sup>0</sup> 16 .818'	78	1.5	2.6	0.31	0.33	43	38	0.78	0.86
Bawrik heda	anta	N25 <sup>0</sup> 3.846'	E076 <sup>0</sup> 16 .482'	98	7.7	9.4	0.36	0.45	78	72	0.68	0.75
Takha	Anta	N25 <sup>0</sup> 4.765'	E076 <sup>0</sup> 16 .004'	60	1.2	1.6	0.25	0.36	56	50	0.94	0.75
Dhaker kheri	anta	N25 <sup>0</sup> 5.946'	E076 <sup>0</sup> 15 .392'	97	1.5	1.9	0.25	0.81	35	31	0.82	0.59
Baran	Baran	N25 <sup>0</sup> 5.807'	E076 <sup>0</sup> 30 .473'	80	2.2	3.4	0.72	0.77	98	93	0.65	0.45
Ambapura	Baran	N25 <sup>0</sup> 4.577'	E076 <sup>0</sup> 30 .034'	92	4.2	6.4	0.52	0.56	125	120	0.91	0.26
Mandola	Baran	N25 <sup>0</sup> 3.782'	E076 <sup>0</sup> 32 .104'	78	1.23	1.6	0.36	0.36	365	340	0.64	0.85
Patera	Baran	N25 <sup>0</sup> 3.773'	E076 <sup>0</sup> 35 .016'	89	3.3	2.9	0.75	0.79	230	210	0.46	0.75
Barana	Baran	N25 <sup>0</sup> 1.062'	E076 <sup>0</sup> 34 .049'	103	3.4	5.2	0.38	0.37	130	120	0.91	0.45
Iklera	Baran	N25 <sup>0</sup> 1.680'	E076 <sup>0</sup> 32 .030'	83	1.2	2.4	0.45	0.47	178	150	0.29	0.56
Bamli	BARAN	N25 <sup>0</sup> 0.057'	E076 <sup>0</sup> 29 .435'	98	3.3	5.1	0.25	0.36	254	230	0.68	0.56
Ratawad	baran	N25 <sup>0</sup> 1.353'	E076 <sup>0</sup> 24 .941'	89	14.5	16.4	0.98	0.96	84	70	0.85	0.86
Bavrikhera	Baran	N25 <sup>0</sup> 6.035'	E076 <sup>0</sup> 33 .782'	102	2.2	3.5	1.4	1.5	122	110	0.65	0.45
Raruti	Baran	N25 <sup>0</sup> 8.819'	E076 <sup>0</sup> 35 .171'	71	16.5	19.1	1.2	1.4	175	140	0.12	0.86
Mjravta	Kishan ganj	N25 <sup>0</sup> 9.379'	E076 <sup>0</sup> 36 .292'	93	2.2	3.4	1.3	1.2	130	125	0.68	0.56
Shygarh	Baran	N25 <sup>0</sup> 1.956'	E076 <sup>0</sup> 36 .934'	71	3.2	2.5	0.87	0.89	210	200	0.55	0.89
Kelwad	Kishan	N25 <sup>0</sup>	E076 <sup>0</sup> 52	90	1.1	3.1	0.28	0.26	53	45	0.19	0.56

a	ganj	8..260'	.782'									
Danta	shahba d	N25 <sup>00</sup> 9..059'	E076 <sup>052</sup> .755'	89	1.7	3.9	0.33	0.35	28	22	0.46	0.75
Pahari	shahba d	N25 <sup>00</sup> 8..592'	E076 <sup>055</sup> .506'	110	1.9	2.3	0.25	0.75	17	11	0.68	0.59
Smrine eya	shahba d	N25 <sup>00</sup> 8..659'	E077 <sup>000</sup> .163'	95	1.6	3.2	0.45	0.44	65	45	0.48	0.86
Mundli ya	Shabad	N25 <sup>01</sup> 1.936'	E077 <sup>007</sup> .437'	107	2.6	4.6	0.26	0.56	56	60	0.65	0.48
Shahba d	shahba d	N25 <sup>01</sup> 4.978'	E077 <sup>009</sup> .710'	97	3.2	5.1	0.24	0.41	35	30	0.28	0.59
Munga wali	Shabad	N25 <sup>03</sup> 1.370'	E077 <sup>012</sup> .503'	82	9.8	11.7	0.36	0.37	98	92	0.46	0.26
Majhari	Shabad	N25 <sup>01</sup> 2.644'	E077 <sup>013</sup> .042'	104	5.2	4.1	0.25	0.65	125	110	0.79	0.85
Balhar ur	shahba d	N25 <sup>01</sup> 0.109'	E077 <sup>013</sup> .584'	85	4.3	6.1	0.36	0.32	365	350	0.53	0.46
Devri	shahba d	N25 <sup>01</sup> 6.551'	E077 <sup>014</sup> .654'	100	3.2	5.1	0.71	0.75	98	89	0.64	0.75
Gajna	shahba d	N25 <sup>01</sup> 6.186'	E077 <sup>013</sup> .599'	108	1.9	3.2	0.71	0.77	250	240	0.26	0.59
Hanotiy a	shahba d	N25 <sup>01</sup> 6.282'	E077 <sup>013</sup> .045'	123	0.8 6	0.9	0.54	0.55	160	150	0.68	0.75
Mamon i	Shabad	N25 <sup>01</sup> 0.837'	E077 <sup>006</sup> .146'	107	2.2	4.5	0.12	0.84	85	100	0.94	0.26
Ratatal	shahba d	N25 <sup>00</sup> 8.363'	E077 <sup>002</sup> .474'	74	3.2	5.3	0.25	0.68	45	75	0.92	0.28
Khushi yara	shahba d	N25 <sup>00</sup> 9.067'	E076 <sup>058</sup> .415'	96	1.5	3.6	0.38	0.45	42	38	0.19	0.45
Phaldi	Kishan ganj	N25 <sup>01</sup> 0.837'	E076 <sup>043</sup> .270'	79	1.5	2.5	0.36	0.65	85	65	0.28	0.75
Barana	Baran	N25 <sup>00</sup> 5.703'	E076 <sup>043</sup> .270'	80	7.7	9.6	0.23	0.22	81	75	0.21	0.95
Chajaw a	atru	N24 <sup>05</sup> 8.909'	E076 <sup>035</sup> .322'	96	1.2	3.6	0.87	0.89	45	65	0.64	0.85
Charda na	Atru	N24 <sup>05</sup> 7.556'	E076 <sup>036</sup> .237'	84	1.5	5.6	0.23	0.78	85	120	0.16	0.42
Piplod	atru	N24 <sup>05</sup> 6.819'	E076 <sup>039</sup> .390'	88	2.1	2.6	0.89	0.85	75	90	0.57	0.56
Jalwara	Kishan ganj	N24 <sup>05</sup> 7.862'	E076 <sup>040</sup> .484'	89	4.2	5.1	0.7	0.75	50	45	0.94	0.85
Marma chah	atru	N24 <sup>05</sup> 4.960'	E076 <sup>037</sup> .719'	96	4.8	6.7	0.81	0.84	110	100	0.75	0.75
Atru	atru	N24 <sup>05</sup> 2.848'	E076 <sup>039</sup> .887'	82	5.9	8.6	0.56	0.75	85	80	0.95	0.59
Mundla	Atru	N24 <sup>05</sup> 0.261'	E076 <sup>039</sup> .359'	87	3.2	2.4	0.25	0.81	45	70	0.64	0.85
Kachra	atru	N24 <sup>05</sup> 1.650'	E076 <sup>037</sup> .873'	79	4.2	5.4	0.85	0.89	120	115	0.48	0.45
Ummed ganj	Atru	N24 <sup>04</sup> 7.816'	E076 <sup>037</sup> .759'	98	13. 1	15.6	0.45	0.74	102	250	0.28	0.85
Dadwar a	atru	N24 <sup>04</sup> 7.816'	E076 <sup>037</sup> .759'	114	5.6	7.9	1	1.3	130	125	0.97	0.85
Katawa r	atru	N24 <sup>04</sup> 7.216'	E076 <sup>032</sup> .536'	93	5.2	7.1	0.36	1.2	95	85	0.49	0.96

Karjuna	atru	N24 <sup>04</sup> 5.033'	E076 <sup>032</sup> .127'	79	2.5	4.9	1.1	0.99	45	120	0.68	0.75
Kanodiya	atru	N24 <sup>04</sup> 7.699'	E076 <sup>030</sup> .273'	88	1.1	3.2	0.36	0.85	85	60	0.42	0.85
Badora	atru	N24 <sup>04</sup> 5.632'	E076 <sup>029</sup> .760'	84	3.5	5.1	0.32	0.36	43	38	0.56	0.95
Mothpur	atru	N24 <sup>04</sup> 4.864'	E076 <sup>037</sup> .423'	92	4.0 2	6.1	0.62	0.59	100	90	0.34	0.86
Kundi	atru	N24 <sup>04</sup> 4.866'	E076 <sup>040</sup> .714'		3.8	2.9	0.88	0.84	170	150	0.57	0.56
Kawai	atru	N24 <sup>04</sup> 5.461'	E076 <sup>044</sup> .082'	113	3.4	5.1	0.91	0.95	110	100	0.43	0.49
Fulbadodha	chabra	N24 <sup>04</sup> 5.952'	E076 <sup>045</sup> .769'	79	2.2	4.3	0.89	0.84	120	115	0.94	0.95
Dilod	chabra	N24 <sup>04</sup> 9.111'	E076 <sup>046</sup> .685'	82	2.8	4.4	0.71	0.74	88	80	0.86	0.59
Sangora	Chabra	N24 <sup>04</sup> 9.629'	E076 <sup>044</sup> .533'	76	3.2	2.4	0.45	0.52	85	90	0.49	0.56
Balharpur	chabra	N24 <sup>04</sup> 9.111'	E076 <sup>046</sup> .685'	84	0.8	0.6	0.85	0.63	45	75	0.67	0.75
Gugor	Chabra	N24 <sup>04</sup> 4.912'	E076 <sup>050</sup> .829'	91	1.1	3.2	0.36	0.45	36	120	0.48	0.59
Chabra	Chabra	N24 <sup>04</sup> 0.682'	E076 <sup>050</sup> .881'	96	2.3	4.1	0.58	0.15	85	250	0.26	0.26
Nipania	Chabra	N24 <sup>03</sup> 7.257'	E076 <sup>051</sup> .962'	84	3.2	3.5	0.12	0.78	42	100	0.18	0.85
Pipalya	chabra	N24 <sup>04</sup> 3.578'	E076 <sup>045</sup> .883'	69	1.7	3.9	0.8	0.84	140	130	0.75	0.45
Salpura	atru	N24 <sup>04</sup> 6.129'	E076 <sup>044</sup> .015'	86	4.5	4.1	0.71	0.77	75	70	0.48	0.56
Rampurabhagtan	Mangro l	N24 <sup>04</sup> 3.578'	E076 <sup>045</sup> .883'	102	2.8	3.4	0.36	0.74	95	150	0.82	0.96
Mangro l	Mangro l	N25 <sup>01</sup> 9.958'	E076 <sup>030</sup> .376'	68	5.3	7.2	0.94	0.96	150	145	0.26	0.45
Mau	Mangro l	N24 <sup>02</sup> 1.372'	E076 <sup>031</sup> .229'	96	8.8	10.6	1.6	1.7	39	32	0.48	0.36
Bhaterian	Mangro l	N25 <sup>02</sup> 4.225'	E076 <sup>032</sup> .325'	84	4.2	3.3	0.45	1.1	45	200	0.79	0.56
Bamori Kalan	Mangro l	N25 <sup>02</sup> 4.679'	E076 <sup>032</sup> .711'	82	3.2	3.3	1.1	1.3	90	85	0.74	0.36
Balapura	Mangro l	N25 <sup>02</sup> 3.584'	E076 <sup>030</sup> .466'	94	2.2	4.2	0.58	0.87	75	120	0.68	0.59
Bhatwara	Mangro l	N25 <sup>01</sup> 7.359'	E076 <sup>030</sup> .311'	108	1.1	3.2	0.36	0.75	69	160	0.94	0.85
Ishwarpura	Mangro l	N25 <sup>01</sup> 7.354'	E076 <sup>032</sup> .142'	96	2.2	2.8	0.12	0.45	84	180	0.29	0.45
Miari	Baran	N25 <sup>01</sup> 3.587'	E076 <sup>033</sup> .023'	85	4.2	9.6	1.1	0.22	29	75	0.48	0.95
Kund	mangro l	N25 <sup>01</sup> 2.948'	E076 <sup>030</sup> .254'	76	6.4	8.2	0.97	0.98	140	130	0.18	0.85
Lisariya	Baran	N25 <sup>00</sup> 9.335'	E076 <sup>031</sup> .396'	95	3.2	5.1	0.25	0.78	103	250	0.68	0.75
Kishan ganj	Kishan ganj	N25 <sup>00</sup> 7.144'	E076 <sup>037</sup> .820'	87	8.0 2	10.0 8	1.3	1.4	160	155	0.76	0.26



Radhapura	Kishan ganj	N25 <sup>00</sup> 9.990'	E076 <sup>038</sup> .657'	74	1.2	1.9	0.12	0.32	145	125	0.91	0.85
Pipalda	Kishan ganj	N25 <sup>01</sup> 1.030'	E076 <sup>039</sup> .680'	81	1.9	3.5	1	0.98	64	60	0.49	0.56
Khedli	Kishan ganj	N25 <sup>01</sup> 1.934'	E076 <sup>042</sup> .517'	89	1.8	2.7	0.45	0.56	84	80	0.56	0.45
Garda	Kishan ganj	N25 <sup>01</sup> 2.286'	E076 <sup>044</sup> .753'	63	2.2	6.2	0.29	0.32	125	100	0.64	0.59
Jainswa	Kishan ganj	N25 <sup>01</sup> 1.308'	E076 <sup>048</sup> .392'	84	1.1	2.4	0.42	0.46	21	18	0.61	0.85
Ghatti	Kishan ganj	N25 <sup>00</sup> 1.125'	E076 <sup>047</sup> .530'	78	1.6	1.9	0.34	0.36	73	65	0.49	0.26
Dhikoniya	Kishan ganj	N25 <sup>00</sup> 2.595'	E076 <sup>047</sup> .522'	80	2.3	4.1	0.25	0.45	46	75	0.65	0.59
Gajran	Kishan ganj	N25 <sup>00</sup> 2.345'	E076 <sup>047</sup> .967'	98	1.2	1.8	0.36	0.63	84	160	0.26	0.23
Fatehpur	Baran	N25 <sup>00</sup> 6.980'	E076 <sup>034</sup> .006'	56	10.1	13.5	0.45	0.52	75	200	0.69	0.58
Nayagon	Chipab arod	N24 <sup>06</sup> 12.676'	E076 <sup>012</sup> 2.425'	87	2.5	3.8	0.88	0.91	100	95	0.48	0.75
Tancha	Chipab arod	N24 <sup>06</sup> 85.836'	E076 <sup>078</sup> 5.008'	84	2.9	2.2	0.55	0.59	180	170	0.84	0.59
Chipab arod	Chipab arod	N24 <sup>06</sup> 22.476'	E076 <sup>007</sup> 2.507'	88	1.1	2.4	0.53	0.61	14	10	0.29	0.45
Khedla	Chipab arod	N24 <sup>06</sup> 45.356'	E076 <sup>005</sup> 2.198'	89	7.6	9.6	0.38	0.36	10	8	0.68	0.26
Setkolu	Chipab arod	N24 <sup>07</sup> 41.452'	E076 <sup>013</sup> 6.422'	60	0.9	2.1	0.47	0.46	45	40	0.26	0.58
Dobra	Chipab arod	N24 <sup>06</sup> 56.556'	E076 <sup>012</sup> 4.425'	68	0.5	0.6	0.4	0.42	9.1	85	0.44	0.26

**Table4:** Correlation coefficients and the nature of correlation for uranium measurements with different physico-chemical parameters in drinking water samples in Pre-monsoon

Physico-chemical parameters	Correlation coefficient (r)	Nature of correlation
pH	-0.00	No correlation
TDS(ppm)	0.04	Weak positive correlation
EC( $\mu$ S/cm)	0.04	Weak positive correlation
ORP(m V)	-0.05	Weak negative correlation
Temperature	0.01	Weak negative correlation
Salinity(ppm)	-0.09	Weak negative correlation
DO (%)	-0.13	Weak negative correlation
Fluoride(ppm)	0.32	Weak positive
Chloride(ppm)	-0.05	Weak negative correlation
Nitrate(ppm)	0.07	Weak positive correlation
Sulphate(mg/l)	0.06	Weak positive correlation
Phosphate(mg/l)	-0.07	Weak negative correlation
Total-hardness(mg/l)	0.18	Weak positive
Ca-hardness(mg/l)	0.10	Weak positive
Mg-hardness(mg/l)	0.25	Weak positive

Phenolphthalein alkanility(mg/l)	0.03	Weak positive correlation
Total alkanility(mg/l)	0.03	Weak positive correlation
Carbonate(mg/l)	0.01	Weak positive correlation
Bicarbonate(mg/l)	0.01	Weak positive correlation

**Table5:** Correlation coefficients and the nature of correlation for uranium measurements with different physico-chemical parameters in drinking water samples in Post-monsoon

Physico-chemical parameters	Correlation coefficient (r)	Nature of correlation
pH	-0.04	Weak positive correlation
TDS(ppm)	0.05	Weak positive correlation
EC( $\mu$ S/cm)	0.05	Weak positive correlation
ORP(m V)	-0.05	Weak negative correlation
Temperature	-0.18	Weak negative
Salinity(ppm)	-0.00	No correlation
DO (%)	-0.17	Weak negative
Fluoride(ppm)	0.32	Weak positive
Chloride(ppm)	-0.02	Weak negative correlation
Nitrate(ppm)	0.06	Weak positive correlation
Sulphate(mg/l)	0.06	Weak positive correlation
Phosphate(mg/l)	0.01	Weak positive correlation
Total-hardness(mg/l)	0.19	Weak positive
Ca-hardness(mg/l)	0.11	Weak positive
Mg-hardness(mg/l)	0.25	Weak positive
Phenolphthalein alkanility(mg/l)	0.04	Weak positive correlation
Total alkanility(mg/l)	0.07	Weak positive correlation
Carbonate(mg/l)	0.04	Weak positive correlation
Bicarbonate(mg/l)	0.02	Weak positive correlation

## CONCLUSION

Uranium levels are found to vary from 0.5-16.5 ppb in pre-monsoon and 0.6-19.1 ppb in post-monsoon respectively. Hence the groundwater samples analyzed by LED Fluorimeter in the present study of Baran districts of Rajasthan were found suitable as ground water but it is recommended that the water requires proper treatment. Drinking water treatment devices can be used to remove specific contaminants such as Uranium, TDS, Total hardness, Fluoride, Nitrate, Chloride, Phosphate, and Salinity etc from drinking water. There are drinking water treatment devices available to reduce the levels of uranium in drinking water to levels below the guideline level of 0.02 mg/L. A water treatment professional should be consulted for advice on a particular situation so that they will be provided with an accurate cost of the available systems, based on specific water quality. If the levels of Uranium exceed its permissible limits, then techniques like Reverse osmosis which is a process that filters most impurities from water by passing it through a very fine membrane. Contaminants such as uranium are left behind on the membrane while treated water passes through is not suitable. We need to install a pre-filter before the reverse osmosis system and also distillation system works by boiling water into water vapour, then returning it to its liquid state. The minerals and contaminants such as uranium form scales and are trapped in the boiling chamber. However, it is well within the safe standard limit of BIS, WHO, USEPA and AERB. There seems to be correlation between the composition of each gamma radiation dose rate and lithological areas. Times to time quantitative and qualitative measurements are needed to constantly monitor the physico-chemical water quality parameters from the various groundwater sources to adopt appropriate remediation strategies. The study concludes that uranium concentration in the Baran district is within permissible limits is ground water used for potable purpose but other parameters viz. Total hardness, TDS, Salinity, Alkalinity, Fluoride and Phosphate etc are above permissible limits in most of the places. Post monsoon average of salinity, fluoride, nitrate, total alkalinity, phosphate, bicarbonate, and uranium are more than pre monsoon average which reflects possibility of leaching of salts during rainy season increasing their correlation in ground water. It is recommended that proper water treatment devices shall be installed at the hand pumps in the villages in the region to remove specific contaminated including fluoride, phosphate and even uranium. The public awareness for health impacts and associated water contaminant is the need of the time low cost water purification devices based on reverse osmosis are suggested for water treatment before drinking.

A weak positive correlation has been observed between Uranium and Total hardness, Ca hardness, Mg hardness, Total alkalinity, Bicarbonate, Carbonate, Fluoride, Nitrate, Sulphate, Phosphate, EC, TDS, Phenolphthalein alkalinity during pre and post monsoon. But there is weak negative correlation between Uranium concentration with pH, ORP, DO, Chloride, Salinity during pre and post monsoon, which may be due to the region's different agricultural activities.

Uranium has a weak positive affinity for fluoride and nitrate ions, uranium may be present in some salt form in drinking water samples. Fluoride and nitrate are uranium carriers, so their determination and study of their correlation are essential. So, it is needful to mention that in the future, nitrate, sulphate, and phosphate concentration in ground water may exacerbate uranium dissolution in the study area as they are good carriers of uranium. The study indicates that the drinking water around the Baran district of Rajasthan does not need any attention from the policymakers regarding uranium and other minerals. It appears instructive to regularly monitor uranium to determine alterations in uranium in Hadoti region of Rajasthan ground water for a unique variation. The higher values of uranium concentration suggest that water in these regions is not safe for drinking purposes and is harmful from a health point of view.

#### ACKNOWLEDGEMENTS

This study was funded by BRNS, DAE under NUP. The Authors would like to acknowledge members of SIESASCN, TSC-4, NRFCC, BRNS; HPD, HS&E Group, BARC and NUP team members for their continuous support in the execution of the project

#### LIST OF REFERENCE

1. Koiliyar, J.G., Pital, P., and Mukadam, A. (2021). Spatial Distribution of Uranium and its associated Water Quality Parameters in Thane Districts Maharashtra. *IJCRT*, 9(4), 2992.
2. Ministry of Jal Shakti Per Capita Availability of Water Posted on :02 MAR 2020 by PIB Delhi.
3. Rao, K.N., Latha, P.S. (2020). Groundwater quality assessment using water quality index with a special focus on vulnerable tribal regions of Eastern Ghats hard rock terrain, Southern India. *Arab. J. Geosci*, 12, 1–16.
4. Maharjan, A.K., Kamei, T., Amatya, I.M., Mori, K., Kazama, F., and Toyama, T. (2020). Ammonium-Nitrogen (NH<sub>4</sub><sup>+</sup>-N) Removal from Groundwater by a Dropping Nitrification Reactor: Characterization of NH<sub>4</sub><sup>+</sup>-N Transformation and Bacterial Community in the Reactor. *Water*, 12, 599.
5. Nurtazin, S., Pueppke, S., Ospan, T., Mukhitdinov, A., and Elebessov, T. (2020). Quality of Drinking Water in the Balkhash District of Kazakhstan's Almaty Region. *Water*, 12, 392.
4. Kadam, A.K., Umrikar, B.N., and Sankhua, R.N. (2020). Assessment of recharge potential zones for groundwater development and management using geospatial and MCDA technologies in the semiarid region of Western India. *SN Appl Sci*, 2(2):312.
7. UNSCEAR, (2016). Sources and effects of ionizing Radiation, United Nations Scientific Committee on the Effect of Atomic Radiation, Annex D – Biological effects of selected internal emitters – Uranium, United Nations, New York.
8. Toxicological Profile for Uranium. (1999). US Department of Health Physics and Human Service. Agency for Toxic Substances and Disease Registry (ATSDR). Atlanta, USA.
9. World Health Organisation (WHO). (1998). Division of Operational Support in Environmental Health. Guidelines for Drinking Water Quality. Vol. 2. Health Criteria and Other Supporting Information: Addendum. Geneva: World Health Organisation.
10. Sridhar Babu, M.N., Somashekar, R.K., Kumar, S.A., Shivanna, K., Krishnamurthy, V., and Eappen, K.P. (2008). Concentration of uranium levels in groundwater. *Int J Environ Sci Tech*, 5, 263-266.
11. Identification and Occurrence of Uranium and Vanadium Minerals from the Colorado Plateaus Geological Survey Bulletin 1009-B.
12. WHO (World Health Organization). (2011). Guidelines for drinking water quality. WHO, Geneva, pp 241–252.
13. Limson, Z. M., Tracy, B.L., Zielinski, J.M., Meyerhof, D.P., Moss, M.A. (1998). Chronic ingestion of uranium in drinking water: a study of kidney bioeffects in humans. *Toxicol Sci*, 43, 68–77.

14. Arzuaga, X., Rieth, S.H., Bathija, A., Cooper, G.S. (2010). Renal effects of exposure to natural and depleted uranium: a review of the epidemiologic and experimental data. *J Toxicol Environ Health B*, 13,527–545.
15. Kurttio, P., Komulainen, H., Leino, A., Salonen, L., Auvinen, A., Saha, H. (2005). Bone as a possible target of chemical toxicity of natural uranium in drinking water. *Environ Health Perspect*, 11,68.
16. Bajwa, B.S., Kumar, S., Singh, S., Tripathi, R.M., and Sahoo, S.K. (2015). Uranium and other heavy toxic elements distribution in the drinking water samples of SW-Punjab, India. *J Radiat Res Appl Sci* ,10,13–19.
17. Kaur, T., Bhardwaj, R., Arora, S. (2017). Assessment of groundwater quality for drinking and irrigation purposes using hydrochemical studies in Malwa region, southwestern part of Punjab, India. *Appl Water Sci*, 7,3301–3316.
18. Jain, C., Bandyopadhyay, A., Bhadra, A. (2010). Assessment of ground water quality for drinking purpose, District Nainital, Uttarakhand, India. *Environ Monit Assess*, 166,663–676.
19. Adimalla, N., Venkatayogi, S., Das, S.V.G. (2019). Assessment of fluoride contamination and distribution: a case study from a rural part of Andhra Pradesh. India. *Appl Water Sci*, 9,94.
20. Ground water Scenario Baran District.(2013).Government of India Ministry of water Resources Central Ground water Board Western Region Jaipur.
21. Hydro geological Atlas of Rajasthan Baran District.(2013).Ground water Department of Rajasthan.
22. BARC. (2012). Standard methods for the examination of water. Bhabha Atomic Research Centre (BARC), India.

## **A Review of Research on the Participation of Private Hospitals in the Functioning of Government-Led Health Insurance Schemes, Across India, with Special Context to Ab-Pmjay Scheme**

**Pallavi Omkar Sawant<sup>1</sup> and Ashok S. Luhar<sup>2</sup>**

<sup>1</sup>D.T.S.S. College of Commerce, Malad, Mumbai, University of Mumbai, India

<sup>2</sup>A. D. K. Degree College of Arts & Commerce, Borivali (West), Mumbai, University of Mumbai, India

### **ABSTRACT**

Ayushman Bharat Pradhan Mantri Jan Arogya Yojana was been established to achieve its goal of having 'Universal Health Coverage' across India and for the same inculcating a robust public-private partnership is a must. This can be justified because, in India, public hospitals are not in a position to cater to the huge audience of the scheme, and also they are sparsely spread to provide proper healthcare facilities to the beneficiaries of the scheme across India. However, private hospitals are not observed that participative in the functioning of government-led health insurance schemes. Therefore, the researcher in this paper is striving to comprehend the reasons for the low participation of private hospitals and also to figure out the relevance of private hospitals in the implementation and functioning of government-led health insurance schemes like AB-PMJAY.

Keywords: Private hospitals, Ayushman Bharat Pradhan Mantri Jan Arogya Yojna, and low-participation

### **INTRODUCTION**

Ayushman Bharat is a Government of India initiative which aims to achieve a Universal Health Coverage (UHC) across India. AB PM-JAY is ideally the largest health insurance scheme in the world which aims in providing a cashless health cover of 5 lakhs per family, per year to over 10.74 crores of poor and vulnerable families which forms the bottom 40% of the Indian population.<sup>1</sup> Benefit of this scheme can be availed through any Public or Private empanelled hospitals that are associated with the AB PM-JAY scheme but in reality participation of private hospitals seems to be questionable. As per a study, it was discovered that the number of private hospitals empanelled under a government-led health insurance scheme was significantly less than the number of private hospitals empanelled under any insurance company. Further, the study states that the potential of empanelment of private hospitals in the AB-PMJAY scheme can be observed to be low, particularly in poor states of the country. This can certainly have a negative implication on the accessibility of the AB-PMJAY scheme in poor states of the country, where prominently a large number of audiences of the scheme is concentrated.<sup>2</sup> Therefore, in this paper, the researcher has strived to discover the extent of participation of private hospitals in functioning government-led health insurance schemes, precisely the AB-PMJAY scheme, and also to ascertain the need of private hospitals in the sustainment of such government-led health insurance scheme by reviewing previous studies done on the same line.

### **OBJECTIVE**

- 1) To understand the extent of participation of private hospitals in the functioning of government-led health insurance schemes across India, with special context to the AB-PMJAY.
- 2) To ascertain the need for participation of private hospitals in the functioning of government-led health insurance schemes across India, with special context to AB-PMJAY.

### **REVIEW OF LITERATURE**

**FORGIA, G.L. & NAGPAL,S. (2012)** in their book have narrated the accountabilities and governance of public hospitals in India. The authors opine that the government-led health insurance schemes provide a shield to public hospitals from market pressures. This has been explained with the help of an example where public hospitals hold 60 percent of the Rashtriya Swasthya Bima Yojana (RSBY) cases and 53 percent of revenues but on the other hand, the book also exclaims that the public hospitals stand nowhere when it comes to competing with private hospitals in providing health care facilities. The authors further concludes that the States should work on building a strong relationship between public and private providers and should also work hard in having the same rate structure after phasing out dual subsidies.<sup>3</sup> Government-led health insurance schemes work mostly with pre-determined health benefits packages and as per **MUKHERJI, A. & SWAMINATHAN, H. (2013)** private hospitals are seen manipulating the fixed health benefits packages. According to the authors, the private hospitals are seen choosing a treatment to be given based on the health packages and not according to the medical condition of the patients.<sup>4</sup> **GANGULY, P., JEHAN, K., DE COSTA, A., MAVALANKAR, D. & SMITH, H. (2014)** conducted a qualitative study to comprehend the approach of private obstetricians towards

government-aided 'Chiranjeevi Yojana'. The results from the study brought out some insights that how private obstetricians are reluctant to join the scheme. The providers feared that CY would lower their status of practice while some feared bureaucratic procedures and perceptions of the scheme.<sup>5</sup> While these were some of the reviews on the participation of private hospitals in the functioning of government-led health insurance schemes, **YADAV, V. et al. (2017)** conducted a narrative-based qualitative study to explore the perception of the private providers as the facilitators in government-run schemes like Janani Suraksha Yojana which is a scheme meant to provide maternity health care services. After many face to face interviews and then on the basis of thematic analysis, the study revealed that low/delay in reimbursement, slow administrative issues, previous ill-experiences, trust issues, and patient-level barriers were some of the barriers to the participation of private health care providers in JSY scheme in Uttar Pradesh.<sup>6</sup> On the same note, **PAREEK, M. (2018)** has raised the concern on empanelment of private hospitals under Ayushman Bharat Pradhan Mantri Jan Arogya Yojana. The paper showcases the difficulty of the private providers to adjust to the restricted health packages of the scheme, as this adjustment demands to make changes in their business model/ strategies which become impractical for them to satisfy their profit motive ideologies.<sup>7</sup> **GULATI, R., SOOD, H. & JHA, B. (2018)** have also drawn some concerns/ challenges of the different stakeholders of the AB-PMJAY scheme from the health care industry in their report. A few of the concerns and challenges related to private hospitals highlighted in the report are again viability of health packages, timely settlement of the claims with no deductions and quality maintenance, and transparency in the work, respectively.<sup>8</sup> Here also the suggestion has been given is to develop a synergy with the private healthcare providers to have better implementation and hold. Apart from the stated reasons above, as per **CHOUDHURY, M., DATTA, P. (2019)**, empanelment of private hospitals was seen less associated with the AB-PMJAY scheme than the insurance companies, and also this empanelment of private hospitals under the scheme was seen low in the states with low per capita income. This low collaboration of private hospitals with the scheme is reasoned out as unwillingness of the hospitals to join the scheme or difference in the entry of the collaboration between scheme and insurance companies.<sup>2</sup> Further, systematic reasoning has been given by **NEOGI, S. (2020)** who states that the empanelment of private providers to deliver secondary and tertiary healthcare to the beneficiaries falls short in two key areas and that is, increasing coverage (in terms of numbers of providers in a given geographic area) and decreasing economic barriers (concerning out of pocket expenditure). According to the author, the shreds of evidence can be segregated into two perspectives, one-ideological and two-pragmatic. To talk about the ideological position, the author points out the State's withdrawal as a service provider of the scheme and transfers this role to private providers per se. The author believes that with the current situation of people directly approaching the private providers, there may be an increase in the number of claims if hospitalized and if no hospitalization is required, it will increase the burden of out-of-pocket expenditure. While talking about the pragmatic perspective, the author proclaims the generation of the scheme as a 'done-deal which makes strategic purchasing inevitable. This perspective argues that the private sector may deliver as per the requirements only if there is robust regulation. However, the author has some hope for the AB-PMJAY scheme as it believes in having a three-tier governance structure (National Health Authority, State Health Agency, and District Empanelment Committee). The author suggests the scheme to focus on the district level which deals with empanelment and thus some control over the private providers. Another suggestion placed by the author is to work hard on strengthening the public providers.<sup>9</sup> Likewise, authors like **KHETRAPAL, S., ACHARYA, A., MILLS, A. (2019)** who conducted their study in two districts of Punjab, Patiala, and Yamunanagar, have also recommended that as AB-PMJAY scheme which is also based on a public-private partnership like RSBY, the former should bring strict monitoring of the private hospitals involved in it and should undertake some regular medical and social audits to govern these private providers.<sup>10</sup> But knowing the reality as well, the dependency of the government-led health insurance schemes like AB-PMJAY scheme is much on the private providers and therefore **ROY, P. (2018)** strongly emphasizes that firstly there should be robust management and governance to develop a good network of private hospitals within the scheme.<sup>11</sup>

## CONCLUSION

Government-led health insurance schemes can be successful in achieving their goal only when it gets the support of private providers. In other words, appropriate measures should be taken by the government to have more inclusion of the private providers as the latter stands to be the main provider of health care facilities even for the latest AB-PMJAY scheme. Also as India lack's in providing proper infrastructural back up to the public hospitals, developing a strong public-private partnership will help in making the healthcare accessible in even remote areas also where the government cannot easily reach otherwise.

---

---

**REFERENCES**

- 1) About/Pmjay. Retrieved April 16, 2022, From Www.Pmjay.Gov.In: <https://www.pmjay.gov.in/about/pmjay>
- 2) Choudhury, M. D. (2019, 02 25). Private Hospitals In Health Insurance Network In India: A Reflection For Implementation Of Ayushman Bharat. National Institute Of Public Finance And Policy , <https://www.nipfp.org.in/publications/working-papers/1849/>.
- 3) Forgia, G. &. (2012). Government Sponsored Health Insurance In India Are You Covered? The World Bank, Washington, D.C.
- 4) Mukherji, A. S. (2013). The Role Of Right To Health In Health Care Management And Delivery In India. *Lim Management Review* , 25 (1), 28-35, <http://dx.doi.org/10.1016/j.limb.2012.11.003>.
- 5) Ganguly, P. J. (2014). Consideration Of Private Sector Obstetricians On Participation In The State Led "Chiranjeevi Yojana" Scheme To Promote Institutional Delivery In Gujarat, India: A Qualitative Study. *Bmc Pregnancy & Childbirth* , 14, <http://www.biomedcentral.com/1471-2393/14/352>.
- 6) Yadav, V. K. (2017). Facilitators And Barriers To Participation Of Private Sector Health Facilities In Government-Led Schemes For Maternity Services In India: A Qualitative Study. *Bmj Open* , 7 (6), E017092; [doi:10.1136/bmjopen-2017-017092](https://doi.org/10.1136/bmjopen-2017-017092).
- 7) Pareek, M. (2018). Ayushman Bharat-National Health Protection Mission A Way Towards Universal Health Cover By Reaching The Bottom Of The Pyramid To Be A Game-Changer Or Non-Starter. *International Journal Of Advanced And Innovative Research*, 7, 1-10, [doi - 10.5281/zenodo.1341912](https://doi.org/10.5281/zenodo.1341912).
- 8) Gulati, R. S. (2018). Medtech: The Keystone Forayushman Bharat. Gurgaon, Haryana: Medical Technology Association Of India (Mtai).
- 9) Neogi, S. (2020). Engagement Of The Private Sector In The Pradhan Mantri Jan Arogya Yojana Examining The Promise Of A Watershed Moment For Universal Health Coverage. *Jindal Journal Of Public Policy*, 4 (1), 30-45.
- 10) Khetrpal, S. A. (2019). Assessment Of The Public-Private-Partnerships Model Of A National Health Insurance Scheme In India. *Social Science & Medicine*, 243, 112634. [10.1016/j.socscimed.2019.112634](https://doi.org/10.1016/j.socscimed.2019.112634).
- 11) Roy, P. (2018). Analysis Of Viability In Health Delivery: A Study Of Rashtriya Swasthya Bima Yojana (Rsby) In Select Districts Of West Bengal, India. *Impact: International Journal Of Research In Humanities, Arts And Literature (Impact: Ijrh)*, 6 (11), 137-142.

## Comparative Thermal Performance Evaluation of Single and Double Twisted Tape Inserted in Evacuated Solar Water Heater

Hitendra Damarlal Chaudhary and Sadanand A. Namjoshi  
Madhav University, Pindwara (Sirohi), Rajasthan, India

### ABSTRACT

The globe has a new choice in the form of alternative energy sources to deal with the current energy problem and environmental concerns. Because wind energy can be beneficial in coastal areas with high wind velocity, and biomass requires either chemically conversion or thermochemical conversion, solar power is the most easily accessible source of useable energy from these three major sources of energy. The present work focuses on evacuated solar water heater with insertion of single and double twisted tape in two different evacuated tube solar water heater to evaluate the thermal performance by varying water flow rate and temperature measurement can be made possible using K type thermocouples.

### INTRODUCTION

The sun is the lifeblood of the entire planet. As society advances, it makes increasing use of a wide range of energy sources. The country's level of development is determined by its energy consumption per capita. More developed a country is one that consumes more energy than its population. Conventional and non-conventional energy sources each have their own set of advantages and disadvantages. Due to the limitations and pollution-causing nature of traditional sources, it is becoming increasingly necessary to turn to non-conventional ones. Basically, solar energy is a flexible source of power because amount of solar radiation are available worldwide, are non-polluting, and can be easily converted into the numerous kinds of energy that are needed. A direct type flow evacuated solar tube collector contains two pipes which runs down and back. The entrance fluid flows via one pipe, while the output fluid flows through the other. The tubes are difficult to be replaced since fluid moves in and out of them. In-depth experimental and mathematical validation were performed by **Selvakumar P et al [1]** on a corrugated plate solar water heater. **A. I. Sato [2]** employed computational fluid dynamics to do a numerical investigation of evacuated solar tube water (CFD). With the developed model in hand, a numerical simulation would be run to assess the behaviour of fluid inside this solar collector as well as potential model enhancements. **I.George et al [3]** carried out optimization of evacuated tube solar water heater using response surface method (RSM). The RSM is used to evaluate the thermal performance of evacuated solar tube collectors using U pipe, as well as to optimise the working parameters. **S. Jaisankar et al [4]** investigated different methods to have improved the heat efficiency of solar water heaters. A full assessment of the limits of existed research, the research gap & potential modification are also included. **K.K. Chonget et al [5]** investigated the use of stationary V-trough collectors in a solarized H<sub>2</sub>O heater. The solar hot water system is efficient in improving by adding the solar absorbers with a simple V-trough reflector. Solar water heater water tubes made of steel, copper, and aluminium were examined by **S.Rajasekaran et al [6]**. A new heating element with a solar collector of the flat plated type is presented in this study in spite of the restricted latent heat of stainless steel and aluminium.

### 2. EXPERIMENTATION

Glass welding was used to create an evacuated tube with an inner diameter of 20 mm and a length of 1000 mm in this study. Material for the storage tank is GI-coated, 150 mm diameter and 600 mm in length. In both single twisted and double twisted forms, mild steel strip is used to make the twisted tape, which has a thickness of 1 mm and measures 1100 mm in length with a pitch of 160 mm and a width of 10 mm. A solo twisted tape insertion setup with a double twisted one tape insertion setup have been created. Temperature readings are made using digital K type thermocouples. Angle sections measuring 25 mm X 25 mm X 5 mm are used to construct the frame. The main water tank has a capacity of 20 litres.



Fig 1 Full Length Evacuated Tube with Coupler



Fig 2 Twisted Tape Materials





Fig 3: Experimental Set up

3. RESULTS AND DISCUSSION

The flow rate in all methods of artificial heat transfer augmentation in both cases is as mention in Table 1. The flow rate is obtained using measuring flask and stop watch by setting tape position at appropriate lactation.

Table 1 Water Flow Rates for a Solar H<sub>2</sub>O Heater in Mass

Flow	Time Required to fill 1000ml Flask (s)	Flow Rate (lps)
Lower	735	0.00137
Medium	695	0.00145
Higher	617	0.00163

The basic objective is to enhance the turbulence in the flow which leads to rate of heat transfer and finally gain in water outlet temperature, but the only drawback is water flow rate at exit of solar water heater is slightly affected by insertion of double twisted tape in the evacuated tube of 20 mm diameter. The temperature rises are found at all flow rate compare to single twisted tape insertion may because of more turbulence in the flow.

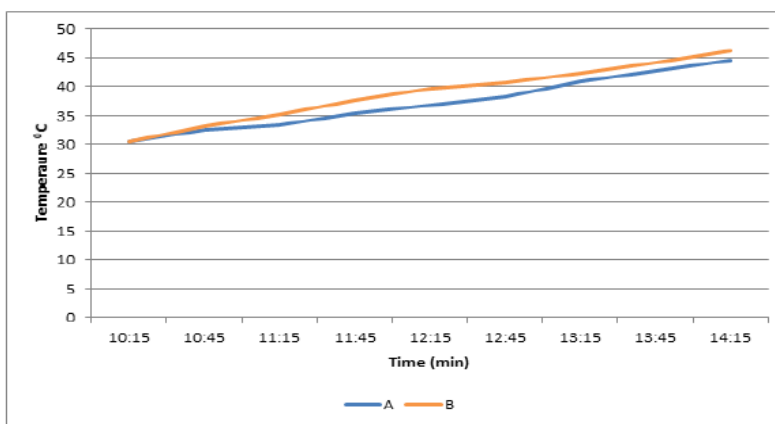


Fig. 2.16 Temperature Variation for Low Flow Rate

A: Single Twisted Tape with Same Pitch in Evacuated Tube B: Double Twisted Tape with Same Pitch in Evacuated Tube

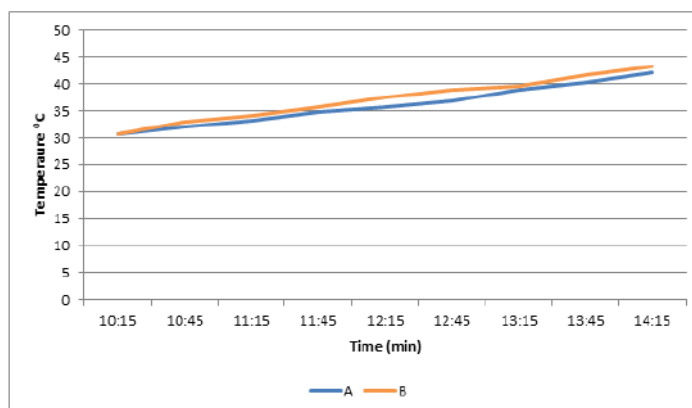
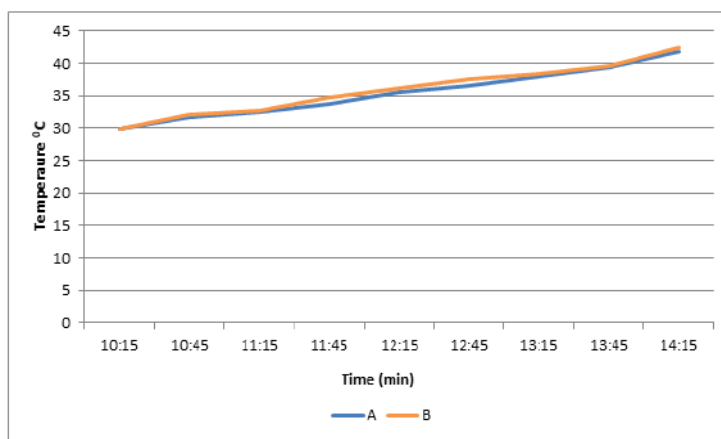


Fig.2.17 Temperature Variations for Medium Flowing Rates



**Fig. 2.18** Temperature Variations for High Flowing Rates

### CONCLUSION

1. Double twisted tape with same pitch insertion shows better results compare to single twisted tape insertion due to increment in flow turbulence.
2. Slightly flow rate get affected due to increment in turbulence leads to pressure drop in the water flow.

### REFERENCES

1. Dr K Ashok Reddy, A Critical Review of Solar Evacuated Tube Collector Used for Enhancement of Heat Transfer Rates, International Journal of Engineering Technology Science and Research Volume 5, 2018.
2. A. L.Sato, V. L. Scalon and A. Padilha, Numerical Analysis of A Modified Evacuated Tubes Solar Collector, International Conference on Renewable Energies and Power Quality Santiago de Compostela (Spain), 2012.
3. I.George, R.Kalaivanan, Optimization of Thermal Performance on Evacuated Tube Solar Collector Water Heating System, Int. Journal of Engineering Research and Application, Volume 7, 2017.
4. S. Jaisankar, J. Ananth, S. Thulasic, S.T. Jayasuthakar, K.N. Sheeba, A Comprehensive Review On Solar Water Heaters, Renewable and Sustainable Energy Reviews Volume 15, 2011
5. K.K. Chong, K.G. Chay, K.H. Chin, Study of A Solar Water Heater Using Stationary V-Trough Collector, Renewable Energy Volume 39, 2012
6. S.Rajasekaran, M.Chandrasekar, T.Senthil Kumar, Performance Analysis Of Coated Solar Flat Plate Collector, International Conference on Energy Efficient Technologies For Automobiles, Special Issue 6: March 2015

## Comparative Thermal Degradation Evaluation of Newspaper and Glossy Paper Constituents

**Samit Kumar Singh\*** and **Sadanand A. Namjoshi**  
Madhav University, Pindwara (Sirohi), Rajasthan, India

### ABSTRACT

Municipal Solid Waste (MSW) consists of papers, plastics, metals, glasses, non-combustible items, and organic composition. The paper waste in MSW is newspaper, cardboard, glossy paper, and printed paper, and the paper waste in MSW is almost 4% of the total sample size. The newspaper and glossy paper are available in MSW constituents in bad shape, and recycling of them is difficult. To extract energy fuel, it is necessary to go for thermal degradation and carry out pyrolysis of newspaper and glossy paper. The knowledge of kinetic studies is important, which is the objective of the present work at corresponding heating rates of 5, 10 and 15 °C/min.

Keywords: Kinetics, Thermogravimetric Analysis (TGA), Differential Thermogravimetric (DTG), Elemental Analysis, Batch Type Pyrolyser.

### I. INTRODUCTION

Energy is the only alternative for the progress of the economy and to satisfy the demand for energy when the fuel resources are diminishing all over the world, alternative energy options have to be explored and the first step towards this is energy-to-waste. Waste-to-energy is the best choice for meeting energy demand while also finding an appropriate solution for municipal solid waste (MSW) from an economic, social, and environmental standpoint, and one of the solutions for this is the thermal degradation process. Waste generation is the outcome of every human activity, and waste may be of industrial, municipal, agricultural, or biomedical waste types. Municipal solid waste (MSW) is increasing at a faster rate due to rapid urbanization and the presence of almost 5-7% paper waste in MSW, which takes more time for degradation. The presence of composed waste of 40–50% creates odor, which is also responsible for health issues.

The MSW generation is increasing at a faster rate due to population growth, particularly in countries like India where old technology such as land filling is not effective due to ground water pollution and scarcity of land. Waste-to-energy is a good option for MSW, and thermal degradation technological options like gasification, pyrolysis, and incineration make decomposition of MSW at faster than land filling and aerobic or anaerobic digestion. Pyrolysis is a process where the feed is thermally destroyed in the absence of oxygen, making it one of the best waste disposal techniques. Solid char, liquid pyrolytic oil, and gases are the end products of pyrolysis. Each of the resulting compounds has the potential to be used as energy carriers and chemical feedstocks in subsequent processing.

**Morcos, V.H. (1988) [1]** analyses the literature on the topic of MSW incineration energy recovery. This report covers (1) both the historical background on MSW disposal methods as well as current developments. (2) Waste's potential as a fuel, based on an understanding of its composition, heating value as well as amount. (3) Alternative waste disposal methods, such as thermal (pyrolysis, refuse-derived fuel, and mass incineration), mechanical, and bio-chemical methods.

In terms of fuel properties, combustion method, pollutants, and ashes utilization/disposal, **Ruth L.A [2]** compares coal and MSW burning. Coal and MSW co-combustion is also discussed. There are MSW concerns that can be resolved by research as well as development. **R.S. Lehrle [3]** investigated (I) Specific pyrolysis parameters to be employed and whereby the technique will be related, namely (a) the nature and size of the sample, and (b) the heating rate of the sample. (II) The best method(s) for investigating the reported pyrolysis behaviour (III) Degradation process interpretation to gather mechanistic insights.

Using thermogravimetric analysis in nitrogen, **Chao-Hsiung Wu et al [4]** reported a kinetic investigation of coated printed and writing paper across the temperature range of 450-900 K at heating rates of 1, 2, and 5 K/min with two stages of decay. **L. Sorum et al. [5]** concentrated on the pyrolysis properties and chemical dynamics of the most major MSW components. Thermogravimetric analyses, including the measurement of kinetic parameters, are carried out in an inert atmosphere at a heating rate of 100 °C/min.

On the premise of a series of TGA studies for cardboard, **C. David et al [6]** addressed the pyrolysis process. The measurement of kinetics variables for cardboard is included in the study. This work also examines the pyrolysis phenomena using a series of TGA experiments, as well as comparing the results of the graphical

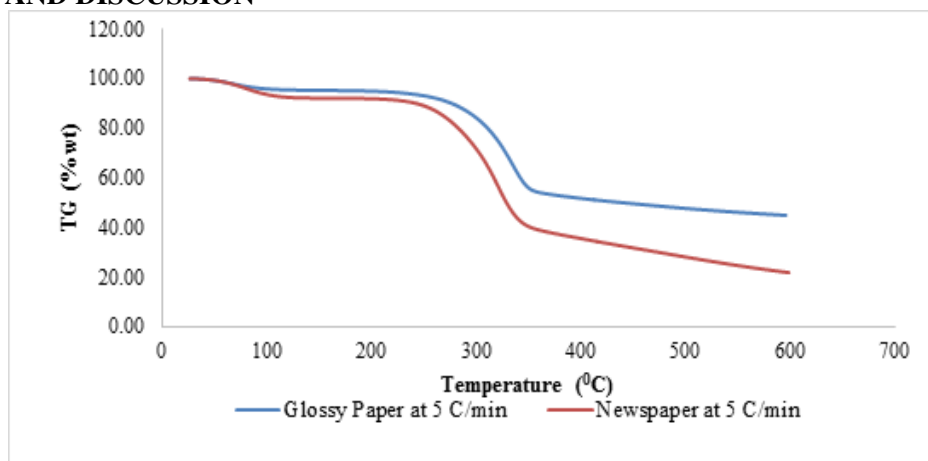
method with simulation solutions that are satisfactory. **Julia Molto et al. [7]** created and tested an order kinetics for the disintegration of old cotton fabrics that explained the behaviour of all the runs. The model for cotton pyrolysis consists of two parallel processes.

## II. METHODOLOGY

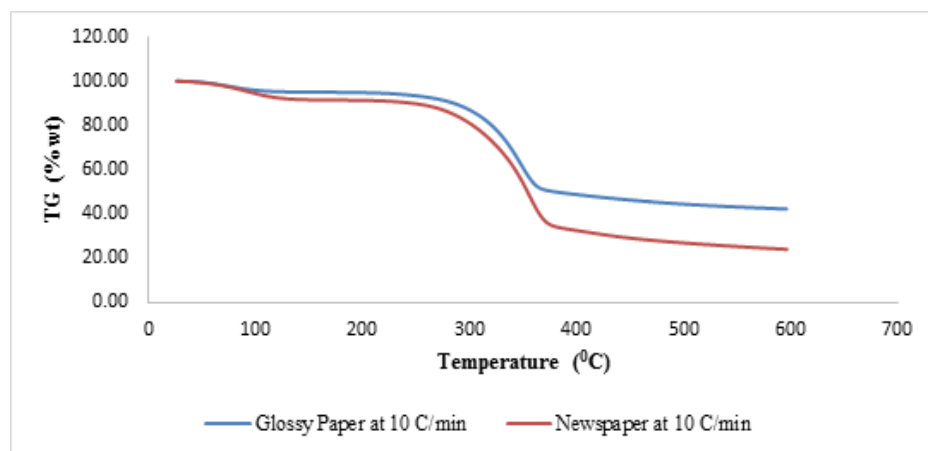
### Thermogravimetric Analysis (TGA)

In the SEIKO TG/DTA-32 thermal system, TGA and DTG were performed. Samples were scanned from room temperature to 600 °C in a nitrogen gas atmosphere at the heating rates ( $\beta$ ) 5, 10, and 15 °C/min and flow rates of 50 ml/min. The maximum amount of sample that can be used is 6 mg. Alumina ( $\alpha$ ) was used as a control and the specimens were put in a platinum crucible.

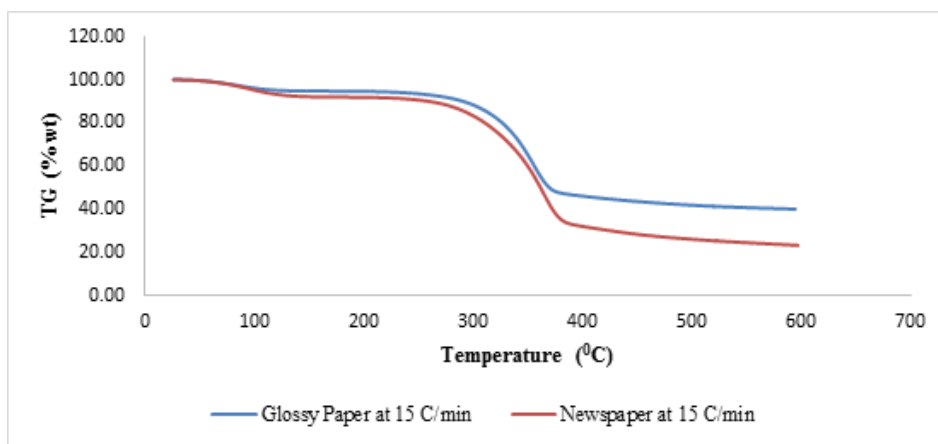
## III. RESULTS AND DISCUSSION



(a)

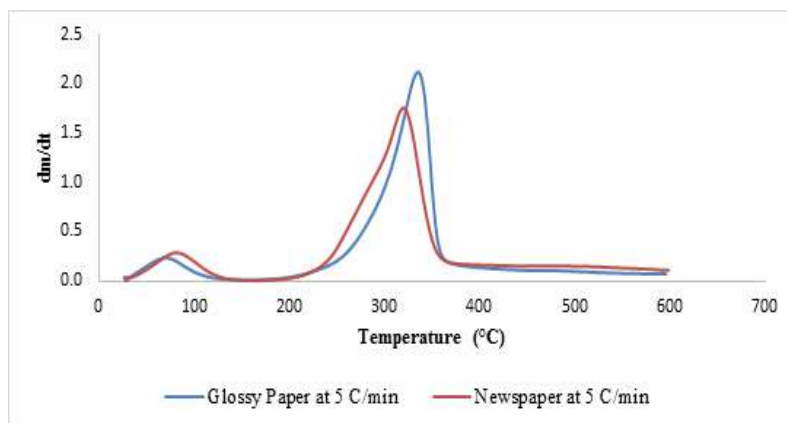


(b)

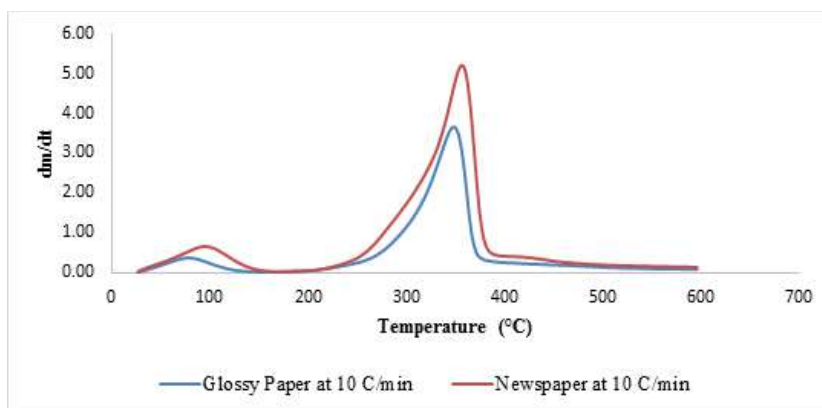


(c)

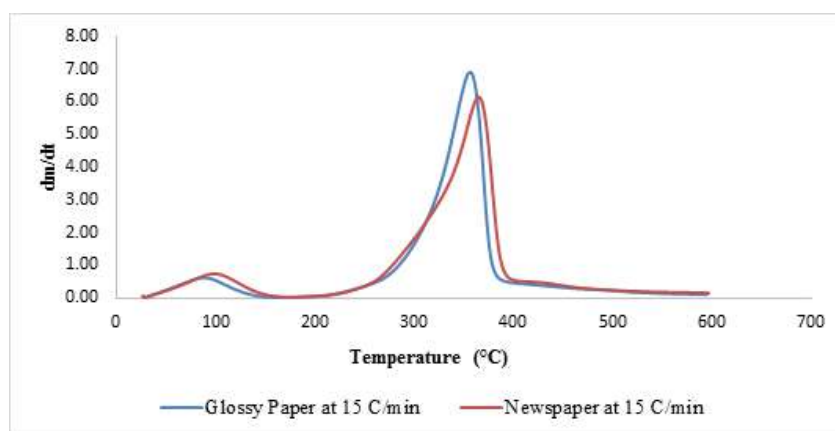
Fig. 1(a, b, c) Thermogravimetric Analysis of Glossy paper and Newspaper



(a)



(b)



(c)

Fig. 2(a, b, c) Differential Thermogravimetric Analysis of Glossy paper and Newspaper

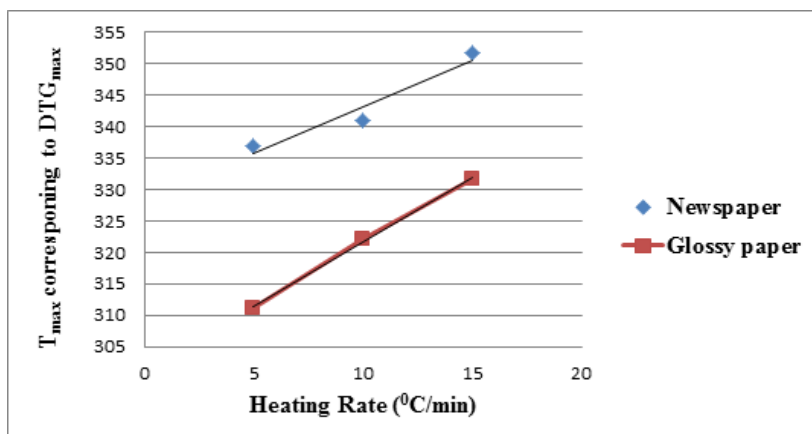


Fig. 3 T<sub>max</sub> Corresponding to DTG<sub>max</sub> Newspaper and Glossy Paper Composition

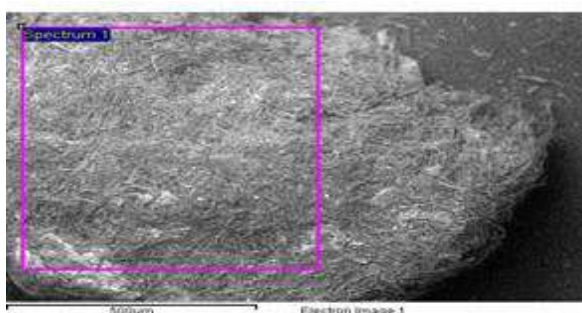
Fig. 1 (a, b, c) and Fig. 2 (a, b, c) show that TGA and DTG for 5, 10, and 15 °C/min heating rates for glossy paper and newspaper. In the case of newspaper, the decomposition rate is faster in the case of all heating rates compared to glossy paper, and from the DTG curve, it is clear that the peak value in the case of newspaper is higher than glossy paper, and the peak in the case of glossy paper is shifted from left to right due to heat transfer resistance. It is noticed that as the heating rate increases, the decomposition rate also increases, yet total decomposition decreases. This could be owing to a lack of decomposition time for finishing the reaction when the heating rate increases.

The three peaks are widely observed in all lignocellulose constituents, and the temperature range in which the greatest peak can be seen varies from 175-250 °C, 300-425 °C, and 450-525 °C, respectively, corresponding to hemicellulose, cellulose, and lignin. It may be because of the presence of clay in the case of glossy paper, but decomposition is quite slow in the case of glossy paper. The decomposition occurs in the second stage, which is in the range of 30–70%. In the case of the first stage, the decomposition is quite slow and is in the range of 6–12%, and the corresponding temperature range varies from 25-275 °C. In the case of glossy paper, the first stage of decomposition is slow compared to any other lignocellulose waste. Fig. 3 indicates maximum decomposition temperature with respect to heating rates and higher temperature values in the case of newspaper due to the high decomposition rate.

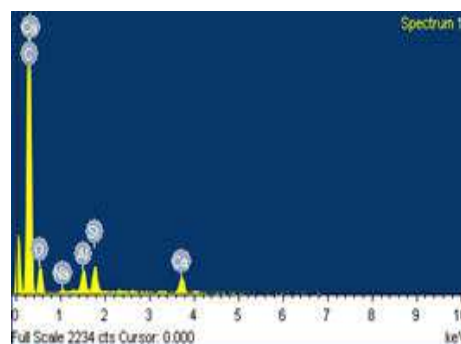
**Table 1** % Weight Loss in Decomposition Stages Corresponding to Range of Temperature

Heating Rate (°C/min)	Stage I		Stage II		Stage III		% Residual remains
	% Weight Loss	Temp Range °C	% Weight Loss	Temp Range °C	% Weight Loss	Temp Range °C	
<b>Newspaper Waste</b>							
5	4.8	30-193.3	56.3	193.3-355.7	24.3	355.7-543.6	14.6
10	5.6	30-233.6	57.1	233.6-361.1	26.1	361.1-538	11.2
15	6.3	30-236.3	58.1	236.3-371.8	26.8	371.8-534.2	8.77
<b>Glossy Paper Waste</b>							
5	10	30-272.5	33	272.5-343.6	18	343.6-542.3	39
10	7	30-255.1	33	255.1-346.3	18	346.3-534.2	42
15	6	30-251	34	251.0-351.7	20	351.7-530.2	40

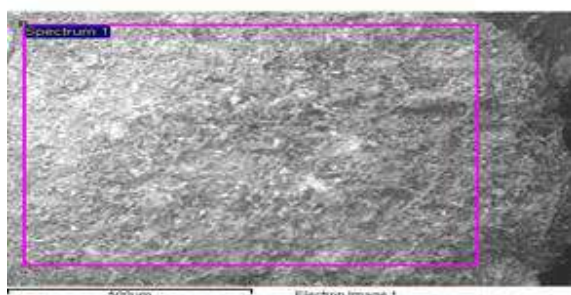
From Table 1, it is clear that with increases in heating rate, residue increases in the case of glossy paper, and in the case of newspaper, residue reduces after the end of thermal decomposition. The temperature range is wider in the case of glossy paper compared to newspaper in all three stages of decomposition.



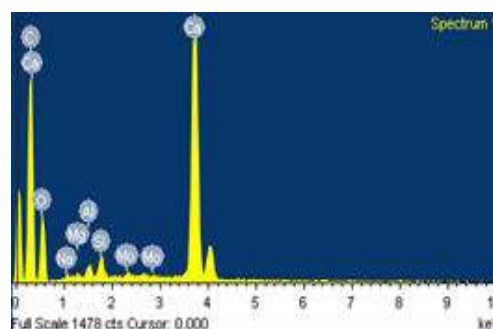
**Fig. 4** Newspaper Residues (10 °C/min)



**Fig. 5** Elemental Spectrum

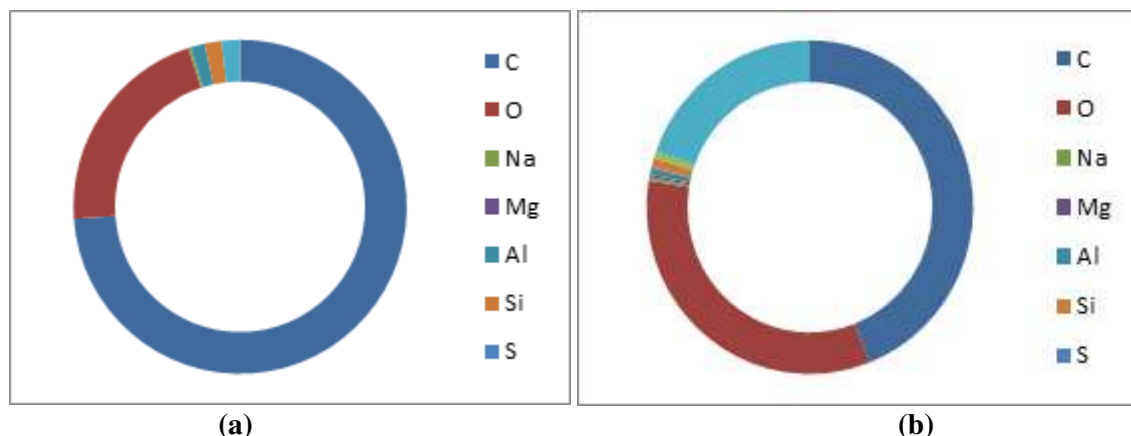


**Fig. 6** Glossy Paper Residues (10 °C/min)



**Fig. 7** Elemental Spectrum

Fig. 4 to 7 shows SEM results and elemental results, which indicate more carbon existence in newspaper than in glossy paper due to high decomposition



**Fig. 8** Graph showing weight% of different elements in  
(a) Newspaper (b) Glossy Paper

**(a) Newspaper (b) Glossy Paper**

Fig. 8 is depicting the weight % of different elements in newspaper and glossy paper, which clearly demonstrates that newspaper has far more carbon elements than glossy paper.

**IV. CONCLUSION**

1. The decomposition rate in the case of a newspaper is higher than on glossy paper.
2. There is more residue existence in the case of glossy paper, and peak values are lower in the case of all heating rates.

**REFERENCES**

1. Morcos, V. H. (1989). Energy recovery from municipal solid waste incineration—A review. *Heat Recovery Systems and CHP*, 9(2), 115-126.
2. Ruth, L. A. (1998). Energy from municipal solid waste: a comparison with coal combustion technology. *Progress in Energy and Combustion Science*, 24(6), 545-564.
3. Lehrle, R. S. (1987). Polymer pyrolysis mechanisms: Experimental approaches for investigating them. *Journal of Analytical and Applied Pyrolysis*, 11, 55-64.
4. Wu, C. H., Chang, C. Y., & Lin, J. P. (1997). Pyrolysis kinetics of paper mixtures in municipal solid waste. *Journal of Chemical Technology & Biotechnology: International Research in Process, Environmental AND Clean Technology*, 68(1), 65-74.
5. Sørum, L., Grønli, M. G., & Hustad, J. E. (2001). Pyrolysis characteristics and kinetics of municipal solid wastes. *Fuel*, 80(9), 1217-1227.
6. David, C., Salvador, S., Dirion, J. L., & Quintard, M. (2003). Determination of a reaction scheme for cardboard thermal degradation using thermal gravimetric analysis. *Journal of Analytical and Applied Pyrolysis*, 67(2), 307-323.
7. Moltó, J., Font, R., Conesa, J. A., & Martín-Gullón, I. (2006). Thermogravimetric analysis during the decomposition of cotton fabrics in an inert and air environment. *Journal of analytical and applied pyrolysis*, 76(1-2), 124-131.

## Pathophysiological Changes in Placenta in Anaemic and Hypertensive Pregnant Women

Shahina Khan<sup>1</sup>, Yogesh Tripathi<sup>2</sup>, Yogesh Kumar Yadav<sup>3</sup>, Dolly Rastogi<sup>4</sup> and Rinku Garg<sup>5</sup>

<sup>1,2</sup>Department of Physiology, Santosh Medical College, Ghaziabad, India

<sup>3</sup>Department of Physiology, Rajarshi Dashrath Autonomous State Medical College, Ayodhya, India

<sup>4</sup>Department of Physiology, GSVM Medical College, Kanpur, India

<sup>5</sup>Department of Physiology, Santosh Medical College, Ghaziabad, India

### ABSTRACT

**Background-** Pregnancy is one of life's most exciting and fulfilling adventure. A healthy mother and a healthy baby is the main target for every pregnancy. So, Infant and maternal mortality has raised concerns since ages. Therefore nowadays ongoing researches in this field aim to develop many successful maternal and infant health care programmes.

**Objective:** A comparative study of pathophysiological changes in placenta in anaemic and hypertensive pregnant women with normal pregnant women.

**Method:** This study was completed in the department of Physiology in collaboration with the department of Obstetrics and Gynaecology and department of Pathology, Govt. Medical College, Kannauj. Permission from the institutional Ethics Committee was taken. Sample size included 150 third trimester pregnant women of age 20-40 yrs. Group I (normal group) included subjects (n=50) with haemoglobin concentration more than 11 gm/dl and normal Blood Pressure- Systolic range 100-139mmHg, Diastolic 60-89mmHg). Group II (anaemic group) included subjects (n=50) with haemoglobin concentration less than 11gm/dl and normal Blood Pressure- Systolic range 100-139mmHg, Diastolic 60-89mmHg). Group III (hypertensive group) included subjects (n=50) with haemoglobin concentration more than 11gm/dl and Blood Pressure-  $\geq 140/90$ mmHg). Gross changes in placental morphology (weight, shape, surface area, thickness, no of cotyledons) and histopathological changes (syncytial knot formation, fibrinoid necrosis, syncytial trophoblastic proliferation, hyalinised villi, calcification in placenta) were duly studied.

**Results:** The placental weight, thickness, surface area were seen significantly higher in anaemic group. In anaemic group, more mean number of cotyledons were observed. Calcified areas, Syncytial knot formation, Fibrinoid necrosis, hyalinised villi, perivillous fibrin deposition, intervillous space, hypovascular villi were seen significantly more in anaemic group as compared to other groups.

**Conclusion:** Anaemia and hypertension in pregnancy may influence morphology and physiology of placenta which in turn adversely affect the perinatal outcome.

Keywords: Anaemia, hypertension, Placenta, Cord blood, Third Trimester.

### INTRODUCTION

Anaemia in pregnancy is a common problem, but severe anaemia during pregnancy may have serious effects on pregnancy, delivery and neonatal infants. Anaemia is a nutritional deficiency disorder and 56% of women living in developing countries are anaemic (World Health Organisation)<sup>1</sup>. Anaemia is known to be associated with multiple factors such as poor socioeconomic status, high parity, short birth interval, poor diet both in quantity and quality, lack of health and nutrition awareness, and a high rate of infectious diseases and parasitic infestation<sup>2</sup>. India has the highest prevalence of anaemia (87%)<sup>2</sup>. In developing countries, underprivileged people have often limited access to medical care and preventive measures, increasing their risk of becoming anaemic and contributing to high maternal mortality<sup>2</sup>.

Indian Council of Medical Research classifies anaemia in pregnancy as Mild: 10.1 to 10.9 g/dl, Moderate: 7.1 to 10.0 g/dl, Severe: 4.1 to 7.0 g/dl, Very severe: 4.0 g/dl and below<sup>4</sup>.

Depending on severity, maternal anaemia can significantly influence morphometric characteristics of placental tissue, pregnancy course and outcome<sup>3</sup>.

Other common problem during pregnancy is hypertension. It is an universal problem and it affects at least 10% of all the pregnancies<sup>17</sup>. Gestational hypertension is defined as increased blood pressure which presents after 20 weeks of pregnancy without any significant proteinuria, this diagnosis is made in women whose blood pressures reaches 140/90 mmHg or greater for the first time after 20 weeks of gestation, but proteinuria is not identified<sup>15</sup>.



The classification for hypertension describes as first gestational hypertension, second Pre-eclampsia and eclampsia syndrome, third chronic hypertension of any etiology and fourth Preeclampsia or chronic hypertension<sup>15</sup>.

Many complications, related to pregnancy induced hypertension occur either due to maternal negligence or unawareness on the disease and its management<sup>16</sup>.

So, in this study we tried to focus on the morphological and histological changes in placenta of anaemic and hypertensive mothers, which may affect the status of the mothers and their foetus. Thus an early diagnosis may allow proper treatment or facilitate proper planning to improve quality of life in these mothers and their newborns.

## **MATERIALS AND METHODS**

This study was conducted in the department of Physiology in collaboration with the department of Obstetrics and Gynaecology and department of Pathology, Govt. Medical College, Kannauj after taking permission from the institutional Ethics Committee.

### **INCLUSION AND EXCLUSION CRITERIA- INCLUSION**

- Pregnant women aged 20-40 years.
- Pregnant women in third trimester from the outpatient department (OPD) or on the day of delivery admitted in labour room or operation theatre.
- Women with primary and multiple pregnancies.
- Pregnant women with normal haemoglobin concentration (>11gm/dl) in group I and haemoglobin concentration (<11gm/dl) in group II were included.
- Non-smokers, non-alcoholic, non-diabetic mothers having perfect sense of physical, mental and psychological well being.

### **EXCLUSION CRITERIA-**

- Elderly women aged more than forty years.
- Pregnant women in 1<sup>st</sup> and 2<sup>nd</sup> trimester.
- Subjects having any history of diabetes, with features of hypo- or hyperthyroidism, patients on any drug therapy, patients with chronic obstructive pulmonary disease and other chronic lung disorders were excluded.
- **Sample size** included in the study was 150 pregnant women aged 20-40 years.
- The subjects that satisfied the inclusion and exclusion criteria were divided into:
  - **1. Group I- Normal healthy group I (n=50)**
  - **2. Group II- Anaemic group II (n=50)**
  - **3. Group III- Hypertensive group (n=50)**
- Eligible participants were recruited and the desirable data of the mothers (age, chronic disease, drug usage, parity, gestational week, history of past illness, history of previous childbirth, problems during pregnancy, mode of delivery, birth weight of the newborn, gender, maturity of the newborn were recorded). Apgar scores at the first and fifth minutes were noted. Placentas with cord and membrane were collected from labour room, operation theatre after delivery for gross and histopathological studies and sent to pathology lab.

### **STATISTICAL ANALYSIS-**

- The data was collected (Basal parameters, SBP, DBP, Placental morphology and histopathology in all three groups) & entered in MS Excel 2016 and analyzed with PASW statistics software (version 20.0; SPSS Inc., Chicago, IL). One-way ANOVA (analysis of variance) was applied to make a comparison among the groups and hypothesis was tested at the level of significance  $\alpha = 0.05$ , i.e. differences between samples was considered as significant if  $p < 0.05$ .

**OBSERVATIONS and RESULTS-**

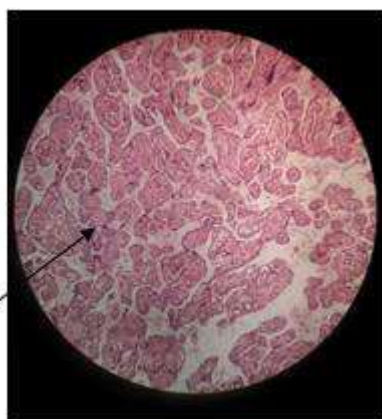
In this study, the weight of newborned baby was observed significantly higher in anaemic group (3364± 347). In anaemic group, the significant higher thickness (3.82±0.35) and surface area (566.89±81.36) of placenta were noted. The more mean number of cotyledons (28.04±2.39) were observed in anaemic group. Calcified areas (27.18±2.14), perivillous fibrin deposition (9.92±1.36), intervillous space (10.24±1.39), hypovascular villi (11.48±0.97) were seen significantly more in anaemic group as compared to other two groups

**Table 1-** Birth weight values in Group I, Group II, and Group III

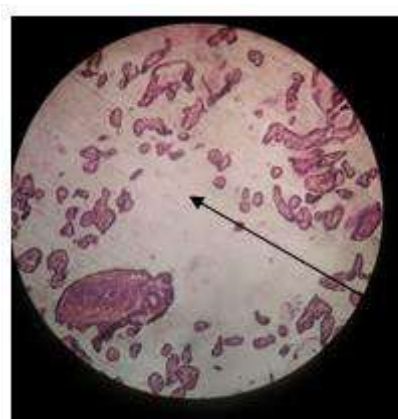
Parameter	Group I Normal mothers	Group II Anaemic mothers	Group III Hypertensive mothers
Birth weight (gm)	3175±210	3364±347**	2408±413

Values are expressed as mean ± SD

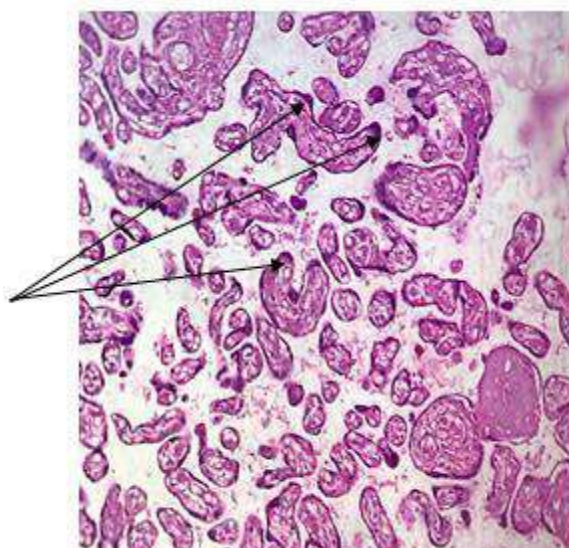
\*\*=p<0.01 (\*\*= Group II Versus Group I, Group II Versus Group III, Group III Versus Group I)



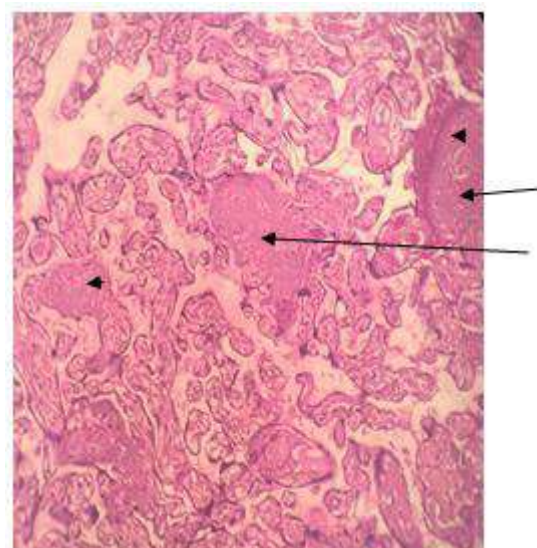
**Fig 1:** Microphotograph showing Placental Villi ( H& E stain,100 x)



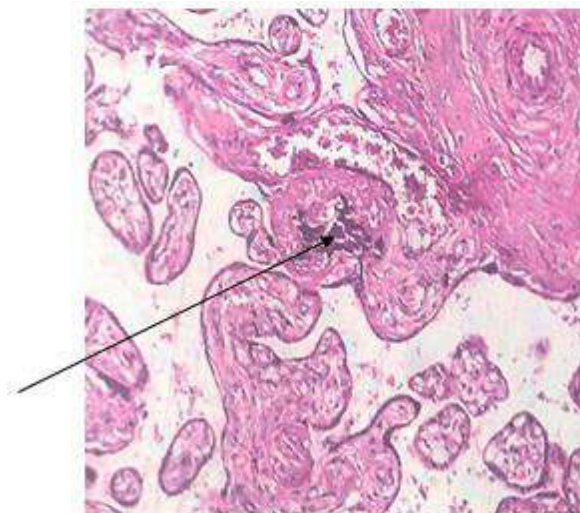
**Fig 2:** Microphotograph showing Increased Intervillous space ( H& E stain,100 x)



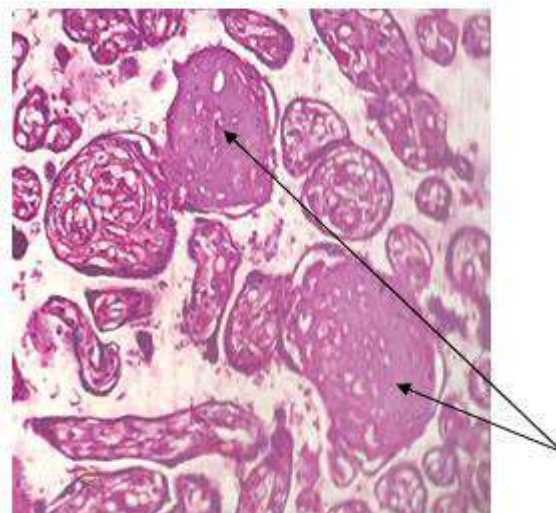
**Fig 3:** Microphotograph showing Syncytial Trophoblastic proliferation



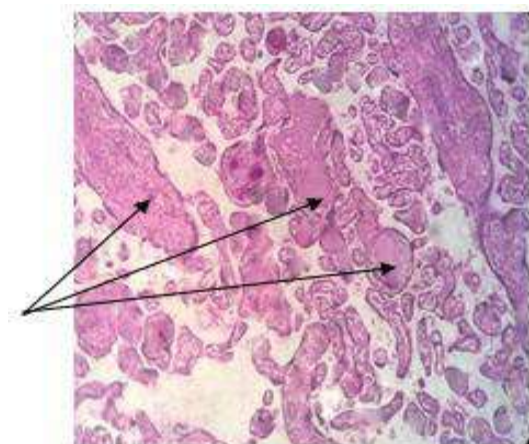
**Fig 4:** Microphotograph showing Fibrinoid necrosis (H& E stain,100 x)



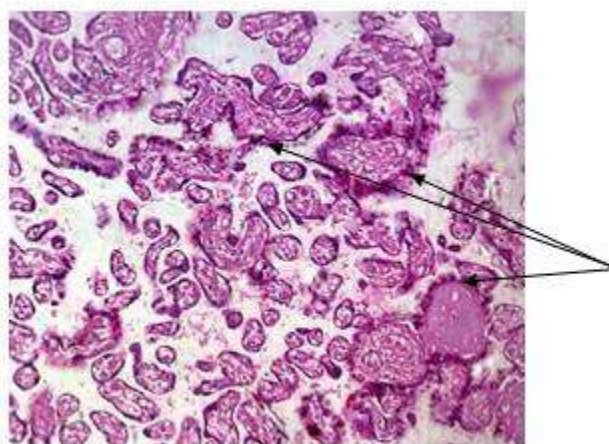
**Fig 5:** Microphotograph showing Calcification (H& E stain,100 x)



**Fig 6:** Microphotograph showing Hyalinized villi (H& E stain,100 x)



**Fig 7:** Microphotograph showing Hypovascular Villi (H& E stain,100 x)



**Fig 8:** Microphotograph showing Perivillous fibrin deposition (H& E stain,100 x)

**Table 2-** Morphometric findings of placenta in Group I, Group II and Group III

Parameter	Group I Normal mothers	Group II Anaemic mothers	Group III Hypertensive mothers
Thickness(cm)	2.60±0.37	3.82±0.35**	2.25±0.60
Surface area(cm <sup>2</sup> )	225.40±32.04	566.89±81.36**	91.35±19.12
Mean no of cotyledons per placenta	16.6±1.66	28.04±2.39**	10.94±1.87

Variables are expressed as mean ± SD

\*\*= p<0.01(\*\*= Group II Versus Group I, Group II Versus Group III, Group III Versus Group I)

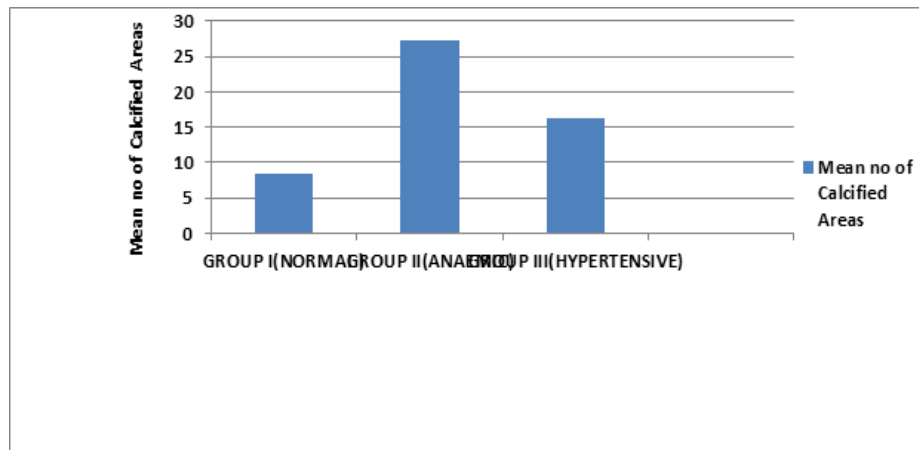
**Table 3:** Microscopic findings of Placenta in Group I, Group II and Group III

Parameter	Group I Normal mothers	Group II Anaemic mothers	Group III Hypertensive mothers
Mean no of areas of Perivillous fibrin deposition per lpf	1.31±1.18	9.92±1.36**	4.68±2.0
Mean no of areas of intervillous space per lpf	5.25±1.15	10.24±1.39**	6.9±3.03
Mean no of areas of Hypovascular villi per lpf	3.62±1.09	11.48±0.97**	6.94±1.20

Values are expressed as mean ± SD

\*\*= p < 0.01 (\*\*= Group II Versus Group I, Group II Versus Group III, Group III Versus Group I)

Figure 1 shows that in normal mothers mean numbers of calcified areas in placenta per lpf were seen as  $8.4 \pm 1.07$ , mean number of calcified areas in placenta per lpf were seen as  $27.18 \pm 2.14$  in anaemic mothers, as  $16.36 \pm 2.52$  in hypertensive mothers. So, the mean number of calcified areas in placenta per lpf were seen significantly higher in anaemic group (\*\*=p<.01).



**Fig.1:** Comparison of mean number of Calcified areas per placenta in Group I, Group II, and Group III

Values are expressed as mean ± SD

\*\*= p < 0.01 (\*\*= Group II Versus Group I, Group III Versus Group I, Group II Versus Group III)

## DISCUSSION

As placental growth and functions are precisely regulated and coordinated to ensure the exchange of nutrients and waste products between mother and fetus and it shares same stress and strain to which the fetus is exposed. Thus, any type of disease affecting mother and fetus also has great effect on placenta.

The changes in placental morphology and physiology are supposed to be due to anaemia in female during pregnancy which leads to maternal hypoxia and it might produces changes on the maternal circulatory system and affects both mother and fetus. Some studies explained that maternal anaemia represents an independent risk factor for abnormal placental growth and hypertrophy. It has been reported that hypoxia can cause morphological changes in placental weight, diameter, thickness and surface area Placental anomalies therefore can be an early warning signs about fetal problem. Besides this, cord blood haematology is a reflection of neonatal genetic effect and maternal factors. The possible explanation for increased weight, diameter, surface area of placenta is that the maternal anemia results in fetal hypoxemia and stimulates placental growth.

## CONCLUSION

The possible explanation for increased weight, diameter, surface area of placenta is that the maternal anemia results in fetal hypoxemia and stimulates placental growth.

Cytotrophoblastic proliferation was found more in anaemic group. It might be for replacement of damaged cytotrophoblast caused by ischemia. Increased fibrosis and formation of Syncytial knots indicates ischemic response under hypoxic condition like maternal anemia or functional inactivity.

## REFERENCES

1. Mondal Chandra Gopal, Baske Anupam, Biswas Sharmistha. Morphological changes of placenta associated with maternal anaemia. *International Journal of Life Sciences Scientific Research* 2017; 3(5):1400-1407.
2. B. N. Seema. Prevalence of anemia among pregnant women in rural Koppal. *International Journal of Reproduction, Contraception, Obstetrics and Gynecology* 2017; 6(9):3792-3795.
3. Lelic Melisa, Bogdanovic Gordana, Ramic Suada, Brkicevic Elvira. Influence of Maternal Anemia during Pregnancy on Placenta and Newborns. *Med Arh* 2014; 68(3):184-187.
4. Mudaliar A L, Menon Krishna M K. (2015) Anemia in Pregnancy. In: Mudaliar A L, Menon Krishna M K. *Clinical Obstetrics* (12<sup>th</sup> edition), Universities press private limited, Hyderabad, pp,162-163.
5. Shah R Amar, Patel Neha, Shah Menka. Hematological parameters in anaemic pregnant women attending

- the antenatal clinic of rural teaching hospital. *Innovative journal of medical and health science* 2012;2(5):70-73.
6. Baske Anupam. Histological changes of placenta in maternal anemia. *Indian Journal of Basic and Applied Medical Research* 2017;6(4):78-87.
  7. Lelic Melisa, Bogdanovic Gordana, Ramic Suada, Brkicevic Elvira. Influence of Maternal Anemia during Pregnancy on Placenta and Newborns. *Med Arh* 2014; 68(3):184-187.
  8. Elgari Mahmoud Mohamed, Waggiallah Hisham Ali. Assessment of haematological parameters of neonatal cord blood in anaemic and non-anaemic mothers. *J Clin Exp Res* 2013; 1(2):22-25.
  9. EMLaflamme. Maternal hemoglobin concentration and pregnancy outcome: a study of the effects of elevation in El Alto, Bolivia. *McGill J Med* 2012; 11(1): 47.
  10. Ren A, Wang J, Ye RW, Li S, Liu JM, Li Z. Low first-trimester hemoglobin and low birth weight, preterm birth and small for gestational age newborns. *Int J Gynaecol Obstet* 2007; 98(2):124-128.
  11. Soni Ritubala, Sharma Vandana, Nair Shema. Study of changes in Placental Morphology Fate of Fetus of Anaemic Mothers. *JEMDS* 2013; 2(31):5830-5844.
  12. Sirpurkar Manik, Anjankar Vaibhav Prakash. Study of correlation between placental morphology and adverse perinatal outcome in different conditions affecting pregnancy. *International journal of Reproduction, Contraception, Obstetrics and Gynaecology* 2015;4(4):1165-68.
  13. S.A.K. Adil, Rumana Nausheen. A study of histo pathological changes of placenta in severe anemia. *Journal of Evolution of Medical and Dental sciences* 2012;1(4):616.
  14. Biswas Sharmistha, Meyur Rudra dev, Adhikari Anjan, Bose Koushik, Kundu Panchanan. Placental changes associated with maternal anaemia. *Eur. J. Anat.*2014; 18(3):165-169.
  15. Mohammed Al-Bahadily AJ, Mohammed Al-Omrani AA, Mohammed M. The effect of pregnancy induced hypertension on complete blood count of newborn. *International Journal of Pediatrics* 2017; 5(9):5667-76.
  16. Prathima P, Anuchitra S. Compliance on antenatal care advices among antenatal mothers with pregnancy induced hypertension in selected hospital Bangalore. *International journal of Advances in Nursing management* 2014; 2(4):196-199.
  17. Dandagi Shweta, Dandagi Shivarajkumar. A study to assess the knowledge of III year GNM students regarding management of pregnancy induced hypertension in selected college of Belgaum Karnataka. *International journal of Advances in Nursing management* 2015; 3(3):190-196.

## **An Exhaustive Survey of Deep Learning Models for Analysis and Classification of Facial Expressions of Kathak Dancers**

<sup>1</sup>Apeksha Khopkar and <sup>2</sup>Ashish Adholiya

<sup>1</sup>MCA, DES's Navinchandra Mehta Institute of Technology and Development, Mumbai, India

<sup>2</sup>MMS, Pacific Institute of Management, Udaipur, Rajasthan, India

### **ABSTRACT**

Classical dance structures in India is a combination of several hand postures and body moments including appropriate facial expressions and emotions corresponding to the background music adopted. Here, owing to the complex nature of this hand gesture position and its meaning, it becomes quite hard enough to understand kathak mudras since it possess "24 classes" of hand posture which are deployed to deliver story of art by way of artists. Several research works have been conducted so far which could support this concern using machine learning, deep learning, support vector machines, convolution neural network, and several other methodologies. This research survey presents the background of facial expressions, the scope of facial expressions classification in dancers and the research problem prevailing in this field. Also the survey describes analysis of the existing research works done in this field with respect to Facial Expression Classification (FEC) and models. This research work serves as a vital knowledge for upcoming research works in this field.

Keywords: convolution neural network, deep learning, kathak, machine learning.

### **I. INTRODUCTION**

Owing to the ability of effective means of communication between the humans and machines, the Facial Expression (FE) detection has become an attractive paradigm of human machine interface system. For the sake of resolving problems such as "pose, lighting and orientation" in diverse methodologies for face and FE based exposure, which is quite important during functionin with the suitable succeeding or analogous approaches. Basically, there are 6 prime expression groups like "happiness, sadness, fear, anger, disgust and grief". In order to attain in depth form of depiction of FE, the "Facial coding System (FACS)" was introduced and here, the motions of the facial muscles were distributed in 44 action units, any of the FE were detailed with the support of their combinations [1, 2]. Basically, there are 2 main phases in a face recognition system and initially defines an efficient representation of the face images which could include sufficient amount of data for future classification. Secondly, the classification of new face image is performed with the preferred representation. Methods to the face recognition system could be generally divided into 3 main categories such as "global or holistic based approach, local approach and hybrid approach". Global means of approach mainly exploits complete face recognition data to determine the features for recognition and it shows definite good response for the facial images of the front view. But it could be sensitive to distinctions that ensued from the imaging aspects. Moreover, the local form of methodology does not affect much from imaging aspects as such form of variants could affect the face image only in a partial manner [8].

Most popular form of FE [3] definition and coding, "Facial Action Coding System (FACS)" was initiated in 1978 which was a measurement of facial measure and "FACS" examined FE by means of coding facial muscle actions into 46 "action units (AUs)". Several worthy collection of mechanisms which were capable of creating a distinction among the diverse human emotional phases such as "being neutral, sadness, fear, surprise, anger, happiness and disgust" have been executed based on this system and some of the correlated systems are found which might deploy facial "AUs" or not. Initially, it is found to be capable of detecting pain or determine its intensity and nevertheless one could perceive that there was relation among the emotional form of states such as unhappiness and surprise which could make it tougher to use the groupings of "AUs" for detecting the pain. Still, it could be probable to deploy "fuzzy classification" by allocating certain membership values to them and this area of research is found to be open to further investigate. Numerous research works have been executed so far to attain more reliable and robust form of system [5, 6, 7, 10].

An emotion could be stated as the physiological and mental form which is subjective and private and which includes actions, behaviors, thoughts and feelings. Said emotions holds an essential key for diverse research objectives in the field of computer vision. Here in [14], the images datasets were organized in a proper manner and are sorted correspondingly and afterwards face was detected in all images with the support of "Haar Filters in OpenCV". This possess few FER classes and then detect, crop and save faces.

Recently, several research works have been conducted in the arena of emotion intensity recognition parameter corresponding to 3 main areas. In that, the first one associates to cross cultural character and here, several studies determined that cultures extremely approve with one other in facial emotion identification and similarly exposed a cross-cultural arrangement in predicting intensity of 2 diverse terminologies for equivalent reaction. Subsequent, area brings forward exploration which could show that there takes place main difference in gender assistances to decode or foresee non-verbal indications. Moreover, woman was found to be more superior in these studies compared to men. In third area, the studies have been directed mainly based on 5 elementary emotions to find out main error forms and effects of emotional intensity in ailments like “schizophrenia, autism, and borderline personality disorder” [11, 12, 13, 16, 18]. This research study provides numerous elements of examining the facial expression based recognition of the symbols and mudras by kathak artists.

The research survey is systematized as follows. The section I includes the importance of FEC among diverse fields. Section II mentions the theoretical background of Navarasas in kathak dancers. Section III denotes the recent papers reviewed from the aspects of deep learning techniques used. Section IV summarizes the research gaps with respect to performance metrics and evaluations presented in this field. Section V presents the findings of the study and some suggestions will be recommended for the future direction.

## II. Theoretic background of the Navarasas in kathak dancers:

न ही रसदृते कश्चीङ्थ प्रवर्तते |  
रसस्यते आस्वाद्यते इति सः रसः ||

The Natya Shastra by sage Bharatamuni dealing with plays and acting computes nine rasas which are feelings or emotional states. These nine types of emotions are also expressed in Kathak and together they include all kinds of experiences that we can normally experience in our day to day life. In Indian heritage, dancers have always been a part and parcel and it is quite familiar from “archaeological excavations” of “Harappa and Mohenjodaro civilisations” where the sculptures projecting numerous positions of dance were uncovered. Postures of dance could be still found extolled on temples of India. “Chidambaram temple” the south part of India has numerous dance postures from classical dance form “Bharatanatyam” [33] carved on the walls of the temple.

Moreover, dance always remained an inspiring terms of acquaintance transfer from one group to other in former periods, a hand written scripts were difficult to find in practice also it stayed as a way of emotional connection between the viewers. Also during previous times, dance was mainly used to describe the stories to publics along using connected “hand gestures, poses and facial means of expressions and actions”. Simple indulgent perspective of understanding of dance, particularly “Indian Classical Dance (ICD)” hang on identification of “hand gestures, poses and facial expressions” connected to it. Earlier kind of works in accepting “ICT” has bidden to infer the actual significance of dance by means of “hand gestures and poses” endorsed by artist. In [20], a deep learning centered method with the support of “convolutional neural networks (CNNs)” is proposed for recognizing emotions connected with distinctive forms of “ICD”.

The artists who performs dance are conveyed by means of song and strict guidelines and it is essential to construe the hand gestures to realize the importance of dance. The “bharatnatyam shastra” describes the “single hand gestures” i.e “Asamyukta Hastah Mudras”: “Pataaka, Tripataaka, Ardhapataaka, Kartarimukha, Mayuram, Ardachandram, Araalam, Shukatunda, Mushthi, Shikhara, Kapitta, Katakamukha, Suchi, Chandrakalaa, Padmakosha, Sarpashirsha, Mri gashirsha, Simhamukha, Kangula, Alapadma, Chatura, Bhramara, Hamsasye, Hansapakshika, Sandamsha, Mukula, Tamrachuda, Trishula”. Further 4 more different hand gestures were further addition to specifically “Kataka, Vyagraha, Ardhasuchi and Palli”. Other than “Sanyukta Hastah mudras” necessitate the necessity of both palms to transfer a specific meaning and twenty- four double handed mudras defined in a “Natya Shastra” such as “Anjali, Kapota, Karkata, Swastika, Dola, Pushpaputa, Utsanga, Shivalinga, Kataka-varadhana, Kartariswastika, Shakata, Shankha, Chakra, Pasha, Kilaka, Samputa, Matsya, Kurma, Varaha, Garuda, Nagabandha, Khatava, Bhairunda, Avahitta”. The sanyukta and the asanyukta mudras are used by the artist to transfer the proper implication of the kavitta or song [21].

For South Indians, “Kathakali” has been a classical form of drama, particularly of Kerala state introduced around 17<sup>th</sup> century and main story of the kathakali dance performance was connected in a manner through the audience by means of hand gestures, FE and dances together with the musical background provision. Basically this art form is practiced by male dancers in theatres plus courts of Hindu expanses. The kathakali hand gestures (KHG) were designated as thorough form of language by itself along with suitable linguistic aspects also language arrangements being connected to it. By using twenty- four hand gestures available, one could be proficient of communicating any form of message to another accurately by using hand positions. In general, it is quite challenging task for usual man to apprehend the actual meaning of kathakali dance drama as of its dance

movements and structure of language. KHG are favorably founded in ancient text “Hastalakshana Deepika” and twenty-four hand gestures (Mudras) as mentioned in ancient text. By means of single as well as with both the hands, mudras are fashioned and the blend of these hand gestures deliver definite importance to them such as any ancient historical epics [15, 19]. Because of the diverse nature of the mudras in several aspects, they represent diverse form of meaning depending on the context.

Dynamic emotion is discovered as a result to deliver ironic form of data than static images and the motion happening through content is primarily seized with the use of the “Motion History Histogram descriptor (MHH)” and is analytically estimated. By depending on this statement, numerous other form of enhancements is suggested with the support of extension lead as “Average Spatial Pooling Multi-Scale Motion History Histogram (ASMMHH)”, which augments 2 specific amendments, one which understand the content sounds varied spatial scopes by means of spatial pooling; which is inclined to the assembly of “CNNs”. Additional variation is to capture motion by various swiftness. By combining, which have proved to attain improved performance than “MHH”, and standard systems such as “Local Binary Patterns – Three Orthogonal Planes (LBP-TOP)”. As a final point, the dynamic emotion content is pragmatic in the feature space, through series of images signified such series of extracted topographies. Unique method known as “Facial Dynamic History Histogram (FDHH)” has established to capture patterns of disparities surrounded by the series of structures; a method not practiced earlier. “FDHH” is pragmatic in a point to point structure for applications in “Depression analysis” along with estimating the encouraged emotions by using huge set of video clips from several films. Blend of DL practices & “FDHH”, state-of-the-art outcomes which are accomplished for depression based examination [34].

### III. RELATED WORK

Some recent papers will be reviewed from the aspects of several methodologies deployed for classifying and analyzing facial expressions such as deep learning and similar ones.

A research survey was analyzed in [4] the application of histogram of focused on granules (HOG) description mentioned “FER” which highpoints the extensive method could be used for the said purpose. Moreover, it specifies an appropriate means of HOG parameters could make descriptor as vital basis to depict and develop FE distinctiveness. Huge demonstration was undergone which could be divided into 3 diverse stages by particularly exploiting a consolidated form of algorithmic pipeline [4]. Research in [9] provides an idea of simplifying the “LS-SVM and PSVM” techniques and unique learning background of “LS-SVM, PSVM” and other forms of regularization algorithms associated to “extreme learning machine (ELM)” which are assembled with functions for generalized form of “single-hidden-layer feed-forward networks (SLFNs)”. Hidden layer, also known as feature mapping in “ELM” are modified [9].

There is a system presented in [17] which could approach faces by deploying a proficient form of “Haar Cascade classifier” and this kind of classifier is trained for detecting the objects. Here [17], the “Haar cascade” has been deployed for detecting faces and it is qualified by learning from a figure of positive images such as faces of people and number of non-positive images. These are the images that are not faces exactly from which features were taken out.

A new approach which could integrate both “MHI-HOG and Image-HOG” by means of temporal normalization technique was proposed in [22] which could determine the changing aspects of the face and body gestures influences recognition. Here, “MHI-HOG” denotes the “Histogram of Oriented Gradients (HOG) on the Motion History Image (MHI)” and it captures the motion route of an interest point as an expression develops in specific time. The “Image-HOG” captures the appearance of the data of suitable remarkable point and the suitable blend of “MHI-HOG” and “Image-HOG” could reciprocate in an effective manner, the local motion and advent information of the face and body gesture for affect recognition. The temporal normalization scheme obviously resolves time resolution concern in the video-based affect recognition [22].

“Specialized pairwise classifiers” trained with diverse feature subsets for FEC was suggested which initially discovers and extracts the faces from images in an automatic manner. Then the face is divided into numerous zones and textural features were taken out from all zone to capture the local data. The extracted features from all zones are then concatenated to model complete face. Pairwise technique which reflects all such sets of classes and hybrid selection approach is deployed to minimize dimensionality concern and to elect appropriate features to distinguish between the certain pair of classes. Various pairwise forms of classes are trained with such pairwise subsets and finally, provided a new face image and whole the features were extracted from that face. Only the previous elected subset of features is given input to all pairwise classifier [23]. 3 types of prevailing “EEG” features are compared for emotion classification for further enhancing the correctness of



“EEG” based emotion classification and envisage the corresponding deviations. Also this presents an effective means of feature smoothing method for eliminating noise separate to emotion and suggests a modest method to track the path of emotion deviations with diverse knowledge [24].

A novel method is presented in [25] for head-pose invariant FER which is mainly established on the set of typical facial points to attain the head pose invariance, the “Coupled Scaled Gaussian Process Regression (CSGPR)” is suggested for normalization of head pose. Initially the mappings among the facial points at all pairs of distinct non-frontal postures were learned in an independent manner. Then the coupling is associated for the purpose of capturing dependences among them. Coupled functions results from diverse poses were joined during inference by means of a gating function and devised depending upon head pose evaluation for query points. Recommended system outperforms earlier works based on regression based methodologies to head pose normalization, “2D and 3D Point Distribution Models (PDMs) and Active Appearance Models (AAMs)”, specifically at times of unidentified poses and demanding training data. Every modality poses its own limitations which, combined with non-structure based actions of natural expressions, create numerous problems for approaches covered in past literatures. This could be probably based on numerous explicit means of feature extraction systems and manual modality fusion. This model specifically uses a classified aspect depiction to assist through unplanned emotions, plus studies how to assimilate numerous modalities for non-verbal emotion recognition. This makes this one appropriate for being discussed in a “HRI” state [26].

A research study was conducted in which time path of incorporation of facial and physical expressions was observed by means of a study of “event-related potentials (ERPs)” while emphasis of attention was influenced. Peculiar incorporating features were established throughout compound phases of treating. At the early stage, threatening data from body was removed predictably quickly, which is demonstrated by enriched P1 amplitudes when the subjects observed compound face-body images with appalling frames associated with happy frames. Next stage, in-congruency amongst emotional facts from face and body was perceived and taken by “N2”. Dissimilar compound images prompted higher “N2s” than organized compatible compound images [27].

A concurrent strong FER function was developed on a smartphone and after, a “deep convolutional neural network” on a “GPU” was trained to organize the FE. The network possess 65000 neurons and entails of five layers and the network of this size unveils significant over-fitting when size of training instances is not enormous. To conflict over-fitting concern, data augmentation and a newly familiarized method named “dropout” were suggested [28].

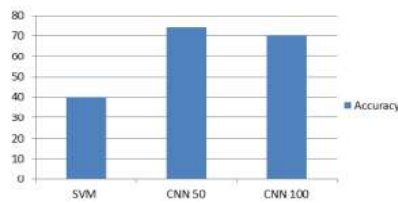
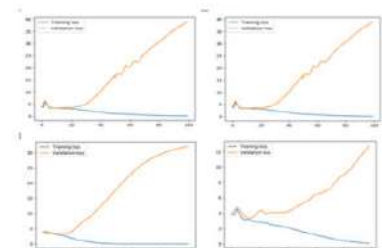
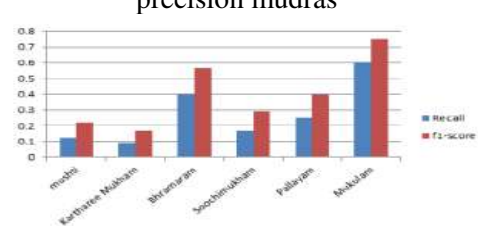
The research work in [29] offers a novel form of local feature descriptor, “Local Directional Number Pattern (LDN)”, for face study: FER. “LDN” encodes the directional information of the face’s textures (i.e., the texture’s structure) in a compacted system manner, generating a further discriminative code than existing approaches.


The delinquent of multiclass expression detection transformed to “triplet-wise expression recognition” and for each expression triplet, a novel feature optimization prototype centered on “action unit (AU)” weighting and patch weight optimization is anticipated to signify the accuracy of expression triplet [30].

Quantifiable topographies of body posture and kinematics and developed behavioral ratings were computed of these feature descriptors to examine their part in affective whole-body movement insight. Representative correspondence examines and classification regression trees were used to inspect the relation of emotional groups to equally added landscapes and behavioral ratings [32].

A pure convolutional neural network approach, presented in [31] outperformed further statistical methods' outcomes accomplished by other authors that embrace feature engineering. Exploiting convolutional networks includes feature learning; which sounds very auspicious for this task where describing features is not trivial. Likewise, the network was estimated by using 2 diverse corpora: one was engaged all through network's training and it was likewise helpful for parameter tuning and for network's architecture description [35]. A couple of machine learning algorithms were examined as well as feature extraction methods which would help to accurately identify human emotion [36]. Countless studies have been done to identify reactions from user's facial expression by computer technologies. In that, the most motivating entity today is identify emotions from body pose. The means of emotion recognition by body pose was reviewed and the term, body posture indicates, it might be “dance movement or person – person communication”. This current study initially surveys specific approaches of emotion recognition from dance actions. Then, the future method to identify the essence of emotions from Indian classical dance “bharathanatyam navarasas” 9 emotions are suggested [37]. The key goal of the research was to progress a vigorous system which could perceive along with making out humanoid

emotion from live feed. There are certain common emotions that are collective to every human kind such as “angry, sad, happy, surprise, fear, disgust and neutral”. Methodology of this system is centered on 2 stages- facial detection is done by extraction of “Haar Cascade” features of a face using “Viola Jones algorithm” and then the emotion is certified and recognized with the aid of “Deep Neural network” [38].

Reference	Author	Title	Work Done	Performance Measure
[39]	Bhavanam et al. (2020)	“Classification of Kathakali Hand Gestures Using Support Vector Machines and Convolutional Neural Networks”	Dataset was developed for kathakali hand gestures and deployed ML and DL to identify them. SVM and CNN was used and classification as performed. Also, matched with the performance of “machine learning algorithms and deep learning algorithms”.	<p>“Deep learning algorithms” up to 74% accuracy level. The potential future works embrace, creating larger dataset, classifying mudras shown in both hands, inferring the “mudra” sense from a video, ascertaining mudras from video streams.</p>  <p>[39] Plots mentioning training and validation loss</p>  <p>Recall and f1-score values for High precision mudras</p> 
[40]	Parameshwaran et al. (2020)	“Unravelling of Convolutional Neural Networks through Bharatanatyam Mudra Classification with Limited Data”	The classification of the mudras beside original labels was carried out by implementing diverse singular pre-trained / non-pre-trained as well as stacked “ensemble convolutional neural architectures (CNNs)”. 27 classes of “asamyukta hasta” data were gathered from “Google, YouTube and few real time performances by artists”	This approach attained an accuracy level of >95%, together in single and double transfer learning models, as well as their stacked ensemble prototype.

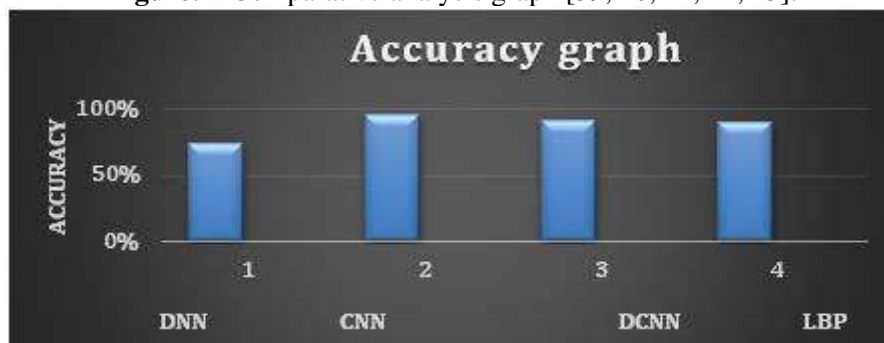
[41]	Jain et al. (2021)	“Enhanced Deep Convolutional Neural Network for Classifying Indian Classical Dance Forms”	An in-depth classification of Indian classical dance ICD forms into 8 categories was accomplished. For classification, suggested “deep convolutional neural network (DCNN)” model using “ResNet50”, which outpaces countless previous methods. Here, the e dimension of the output volume achieved over $(n + 2 \times p - f) \div s + 1$	accuracy score of 0.911. In future work, additionally anticipate to increase the dataset size and discover the problem statement with a perspective of auto-generation dance poses and mudras.																					
[42]	Kale et al. (2019)	“Classification of expressions in Indian Classical Dance using LBP”	Here, the vaeiation of the expression from neutral face is intended using template matching and SVM approach.	<p>More than 90% recognition rate is accomplished for utmost of the expressions.</p> <table border="1" data-bbox="1042 853 1406 1055"> <thead> <tr> <th>Class</th> <th>LBP+ Template Matching</th> <th>LBP+ SVM</th> </tr> </thead> <tbody> <tr> <td>Neutral-Happy</td> <td>95%</td> <td>95%</td> </tr> <tr> <td>Neutral-Angry</td> <td>55%</td> <td>55%</td> </tr> <tr> <td>Neutral-Surprised</td> <td>100%</td> <td>95%</td> </tr> <tr> <td>Neutral-Disgusted</td> <td>85%</td> <td>85%</td> </tr> <tr> <td>Neutral-Fearful</td> <td>95%</td> <td>95%</td> </tr> <tr> <td>Neutral-Sad</td> <td>85%</td> <td>100%</td> </tr> </tbody> </table> <p>[42]</p>  <p>Here, neutral and angry based faces shows more variation factor in eyes.</p>	Class	LBP+ Template Matching	LBP+ SVM	Neutral-Happy	95%	95%	Neutral-Angry	55%	55%	Neutral-Surprised	100%	95%	Neutral-Disgusted	85%	85%	Neutral-Fearful	95%	95%	Neutral-Sad	85%	100%
Class	LBP+ Template Matching	LBP+ SVM																							
Neutral-Happy	95%	95%																							
Neutral-Angry	55%	55%																							
Neutral-Surprised	100%	95%																							
Neutral-Disgusted	85%	85%																							
Neutral-Fearful	95%	95%																							
Neutral-Sad	85%	100%																							
[43]	Mohanty and Sahay, (2018)	“Rasabodha : Understanding Indian classical dance by recognizing emotions using deep learning”	This work attempts to interpret the significance of “Navarasas” connected with ICD” and suggests a dataset of numerous emotions (“Navarasas”) shown in ICD encompassing “RGB” images with supplementary depth information. This is collected using the “Microsoft Kinect sensor”. A “deep learning framework” is suggested using CNN to comprehend the semantic meaning	<p>With the support of the emotions enacted by the dancer, plenty possibility to expand the strength of the suggested approach so as to handle the 725 complexities related with real-world videos of “ICD”. Future work focuses on control obstructions and variations for recognition of “Navarasas” in practical dance videos.</p> <table border="1" data-bbox="997 1760 1449 1991"> <thead> <tr> <th>No. of Classes</th> <th>Training set</th> <th>Test set</th> <th>Feature vector</th> <th>Accuracy</th> </tr> </thead> <tbody> <tr> <td rowspan="4">8</td> <td rowspan="4">960</td> <td rowspan="4">160</td> <td>HoG + SVM</td> <td>93.125%</td> </tr> <tr> <td>SIFT</td> <td>69.375%</td> </tr> <tr> <td>SURF</td> <td>39.37%</td> </tr> <tr> <td>BRISK</td> <td>15.0%</td> </tr> <tr> <td></td> <td></td> <td></td> <td>LBP+SVM</td> <td>66.75%</td> </tr> </tbody> </table> <p>[43]</p>	No. of Classes	Training set	Test set	Feature vector	Accuracy	8	960	160	HoG + SVM	93.125%	SIFT	69.375%	SURF	39.37%	BRISK	15.0%				LBP+SVM	66.75%
No. of Classes	Training set	Test set	Feature vector	Accuracy																					
8	960	160	HoG + SVM	93.125%																					
			SIFT	69.375%																					
			SURF	39.37%																					
			BRISK	15.0%																					
			LBP+SVM	66.75%																					

			connected with videos of "ICD" by identifying "Navarasas" endorsed by the artist.	
--	--	--	---	--

**Table: 1** Empirical contribution using deep learning algorithms

The graph presents the comparative analysis of several methods with its accuracy level.

**Figure: 1** Comparative analysis graph [39, 40, 41, 42, 43].



#### IV. RESEARCH GAPS

Because of the use of blend of various mudras in a peculiar manner which denotes diverse meaning, except one who is well proficient with these symbols, its meaning and purpose, it becomes quite demanding task to recognize and admire the particular art. Some of the mudras even relate more of the contextual meaning of the background music or story of the art [15].

Even though the idea of the engaging primary choice of prominent facial components and similar ER phase were depending on the geometrical and textural features has been researched in detail, the classification performances which were achieved do not meet up with the serious requirements of the system. Moreover, the major criteria are the mismatch in aligning works in diverse facial images particularly in case of extreme expressions and also consumed huge amount of time owing to the load for the adequate pulling of facial elements. This occurred when an iterative strategy was used and were found irrelevant for the real world practical applications if low power systems were deployed [4].

#### V. CONCLUSION

In the current research study, the major research works conducted on the deep learning and other models for classifying the facial expressions of the kathak dancers are described. Here, the major issue of recognition of the mudras and facial expressions of these artists are mentioned and numerous machine learning and deep learning based parameters are discussed for the same. Future research work aims to frame such hybrid deep learning models for better recognition and classification purpose.

#### VI. REFERENCES

1. Khan, M., İ, Bhuiyan A., "Facial Features Approximation for Expression Detection in Human-Robot Interface", Sixth International Conference on Intelligent Information Hiding and Multimedia Signal Processing, 2010.
2. Baswaraj, D, Govardhan, A & Premchand, P 2012, 'Active contours and image segmentation', The current state of the art. Global Journal of Computer Science and Technology.
3. Bouzalmat, A, Belghini, N, Zarghili, A & Kharroubi, J 2011, 'Face Detection and Recognition using Back Propagation Neural network and Fourier Gabor filters', Signal & Image Processing, vol. 2, no. 3, p. 15.
4. Carcagni, P, Coco, M, Leo, M & Distante, C 2015, 'Facial expression recognition and histograms of oriented gradients: a comprehensive study', SpringerPlus, vol. 4, no. 1, p. 1.
5. Chen, X & Cheng, W 2015, 'Facial expression recognition based on edge detection', International Journal of Computer Science and Engineering Survey, vol. 6, no. 2, p.1.
6. Harihara Santosh Dadi & Gopala Krishna Mohan Pillutla 2016, 'Improved Face Recognition Rate Using HOG Features and SVM Classifier. IOSR Journal of Electronics and Communications Engineering, vol. 11, issue 4, pp 34- 44.

7. Gosavi, AP & Khot, SR 2013, 'Facial expression recognition using principal component analysis', *International Journal of Soft Computing and Engineering (IJSCE)*, vol. 3, no. 4, pp. 2231-2307.
8. He, B, Xu, D, Nian, R, van Heeswijk, M, Yu, Q, Miche, Y & Lendasse, A 2014, 'Fast face recognition via sparse coding and extreme learning machine', *Cognitive Computation*, vol. 6, no. 2, pp. 264-277.
9. Huang, GB, Zhou, H, Ding, X & Zhang, R 2012, 'Extreme learning machine for regression and multiclass classification,' *IEEE Transactions on Systems, Man, and Cybernetics*, vol. 42, no. 2, pp. 13-9.
10. Kharghanian, R., Peiravi, A., & Moradi, F. (2016). Pain detection from facial images using an unsupervised feature learning approach. Paper presented at the 2016 38th annual international conference of the IEEE engineering in medicine and biology society (EMBC).
11. Malayala Divya, R Obula Konda Reddy, C Raghavendra, Effective Facial Emotion Recognition using Convolutional Neural Network Algorithm, 2019.
12. U M Prakash, Pratyush, Pranshu Dixit, Anamay Kumar Ojha, Emotional Analysis Using Image Processing, 2019.
13. Dhvani Mehta, Mohammad Faridul Haque Siddiqui, Recognition of Emotion Intensities Using Machine Learning Algorithms: A Comparative Study, 2019.
14. Shivam Gupta, Facial emotion recognition in real-time and static images, *Proceedings of the Second International Conference on Inventive Systems and Control (ICISC 2018) IEEE Xplore Compliant - Part Number: CFP18J06-ART, ISBN:978-1-5386-0807-4; DVD Part Number: CFP18J06DVD, ISBN:978-1-5386-0806-7.*
15. Bhavanam, Lakshmi & Iyer, Ganesh. (2020). On the Classification of Kathakali Hand Gestures Using Support Vector Machines and Convolutional Neural Networks.
16. Sanjay Kumar K K R, Subramani G, Thangavel S and Parameswaran L (2021) A Mobile- Based Framework for Detecting Objects Using SSD-MobileNet in Indoor Environment. In: Peter J., Fernandes S., Alavi A. (eds) *Intelligence in Big Data Technologies—Beyond the Hype. Advances in Intelligent Systems and Computing*, vol 1167. Springer, Singapore.
17. Sravya, A S L, Chinmayi, K S, Yoshita and L N. A Smart Aid for Visually Challenged in Face Detection and Recognition (2019) *Proceedings of the 2nd International Conference on Smart Systems and Inventive Technology, ICSSIT 2019.*
18. G Raju, Madhu S Nair, A fast and efficient color image enhancement method based on fuzzy-logic and histogram, *AEU - International Journal of Electronics and Communications*, Volume 68, Issue 3, 2014, Pages 237-243, ISSN 1434- 8411.
19. C Selvi, Y Anvitha, C H Asritha and P B Sayannah, Kathakali face expression detection using deep learning techniques. *Journal of Physics: Conference Series*, 2062, 2021.
20. Aparna Mohanty, Rajiv R. Sahay, Rasabodha: Understanding Indian classical dance by recognizing emotions using deep learning, *Pattern Recognition (2018)*, doi: 10.1016/j.patcog.2018.01.035
21. A. Mohanty, P. Vaishnavi, P. Jana, A. Majumdar, A. Ahmed, T. Goswami, R. R. Sahay, Nriyabodha: Towards understanding indian classical dance using a deep learning approach, *Signal Processing: Image Communication* 47 (2016) 529-548.
22. S. Chen, Y. Tian, Q. Liu, D. N. Metaxas, Recognizing expressions from face and body gesture by temporal normalized motion and appearance features, *Image and Vision Computing* 31 (2) (2013) 175-185.
23. M. J. Cossetin, J. C. Nievola, A. L. Koerich, Facial expression recognition using a pairwise feature selection and classification approach, in: *IEEE International Joint Conference on Neural Networks*, 2016, pp. 5149-5155.
24. X.-W. Wang, D. Nie, B.-L. Lu, Emotional state classification from EEG data using machine learning approach, *Neurocomputing* 129 (2014) 94-106.
25. O. Rudovic, M. Pantic, I. Patras, Coupled Gaussian processes for pose-invariant facial expression recognition, *IEEE Transactions on Pattern Analysis and Machine Intelligence* 35 (6) (2013) 1357-1369.

26. P. Barros, D. Jirak, C. Weber, S. Wermter, Multimodal emotional state recognition using sequence-dependent deep hierarchical features, *Neural Networks* 72 (2015) 140–151.
27. Y. Gu, X. Mai, Y.-j. Luo, Do bodily expressions compete with facial expressions? time course of integration of emotional signals from the face and the body, *PLoS One* 8 (7) (2013) 736–762.
28. I. Song, H.-J. Kim, P. B. Jeon, Deep learning for real-time robust facial expression recognition on a smartphone, in: *IEEE Conference on Consumer Electronics*, 2014, pp. 564–567.
29. A. R. Rivera, J. R. Castillo, O. O. Chae, Local directional number pattern for face analysis: Face and expression recognition, *IEEE Transactions on Image Processing* 22 (5) (2013) 1740–1752.
30. W. Xie, L. Shen, M. Yang, Z. Lai, Active AU based patch weighting for facial expression recognition, *Sensors* 17 (2) (2017) 275–297.
31. K. Simonyan, A. Zisserman, Very deep convolutional networks for large- scale image recognition, arXiv preprint arXiv:1409.1556.
32. Poyo Solanas, M. et al. (2020) The role of computational and subjective features in emotional body expressions. *Sci. Rep.* 10, 6202
33. Mukhopadhyay, D., and Miyapuram K.P. (2016). An eye-tracking study of nine facial emotional states (Nava Rasa) in the Indian classical dance genre of Bharatanatyam. Accepted as talk in the 3rd Annual Conference on Cognitive Science (ACCS-2016), 3rd to 5th October 2016, Indian Institute of Technology, Gandhinagar.
34. Jan, A. (2017). Deep learning based facial expression recognition and its applications (Doctoral dissertation, Brunel University London).
35. Spiers, D. L. (2016). Facial emotion detection using deep learning.
36. Raut, N. (2018). Facial Emotion Recognition Using Machine Learning.
37. Pallavi, Ponnusamy. (2017). Emotion Recognition By Dance Movement – A Survey, *International Journal of Scientific & Engineering Research* Volume 8, Issue 7, July-2017 ISSN 2229-5518.
38. Sharma, J. J. S., & Dugar, Y. (2018). Detection and recognition of human emotion using neural network. *Int J Appl Eng Res*, 13(8), 6472-6477.
39. Bhavanam, L. T., & Iyer, G. N. (2020, January). On the classification of Kathakali Hand Gestures using support vector machines and convolutional neural networks. In *2020 International Conference on Artificial Intelligence and Signal Processing (AISP)* (pp. 1-6). IEEE.
40. Parameshwaran, A. P., Desai, H. P., Weeks, M., & Sunderraman, R. (2020, January). Unravelling of convolutional neural networks through Bharatanatyam Mudra classification with limited data. In *2020 10th Annual Computing and Communication Workshop and Conference (CCWC)* (pp. 0342-0347). IEEE.
41. Jain, N., Bansal, V., Virmani, D., Gupta, V., Salas-Morera, L., & Garcia-Hernandez, L. (2021). An enhanced deep convolutional neural network for classifying indian classical dance forms. *Applied Sciences*, 11(14), 6253.
42. Kale, M. R., & Rege, P. P. (2019, December). Classification of expressions in Indian Classical Dance using LBP. In *2019 IEEE 16th India Council International Conference (INDICON)* (pp. 1-4). IEEE.
43. Mohanty, A., & Sahay, R. R. (2018). Rasabodha: understanding Indian classical dance by recognizing emotions using deep learning. *Pattern Recognition*, 79, 97-113.

## Analyzing Mapping of ISO 27001: 2013 Controls for Alignment with Enterprise Risks Management

Ashish Ukidve<sup>1</sup>, S. S Mantha<sup>2</sup> and D. N. Reddy<sup>3</sup>

<sup>1</sup>Vidyalankar Polytechnic, Mumbai, India

<sup>2</sup>AICTE, Chancellor-KL University, Andhra Pradesh, India

<sup>3</sup>Osmania University, Former VC, JNTUH, India

### ABSTRACT

ISO 27001:2013 and ISO27001:2017 have been formulated by the International Organization for Standardization (ISO) which are upgrades of ISO27001:2005. ISO 27001:2005 provided guidelines for the ISMS implementation, however emphasis for monitoring specific controls and processes was seldom provided by this standard. The standard did not provide guidelines to accomplish concurrency with the Enterprise Risk assessment and mitigation. The revised version of ISO 27001:2013 has added more security controls and built in changes in the standard's specific sections. The new domains introduced provide alignment with Enterprise Risk Management (ERM) standard ISO 31000. While 2017 version has addition of service delivery section, other domains and controls of 2013 have remained unchanged. This paper presents comparative study of the two versions of ISO27001:2005 and ISO27001:2013. It also explores alignment of ISO27001:2013 with enterprise risk management standard ISO31000.

This alignment would improve corporate governance of the organisations. It would also help in effective implementation risk management processes.

Keywords: ISMS, ISO27001:2005, ISO27001:2013, governance, enterprise risk management, Strategic risk Management

### INTRODUCTION

In today's scenario, most organizations need to adopt the approach of Enterprise Risk Management (ERM) to minimize the residual risks. This may be due to quality focus or emphasis on a performance initiative or due to risks related to information security. Organizations must set benchmarks objectives for risk management by which they will assess the performance of their risk management processes.

For organizations information and knowledge have become critical assets. Identifying and implementing suitable technologies for safeguarding confidentiality and integrity of information have become essential components of information systems. Information availability and regulatory compliance pose to be crucial challenges. In view of the above and the evolving landscape of cyber threats, ISMS implementation and obtaining ISO 27001 certification; have proven to be prudent for effective Enterprise Risk Management (ERM).

International Organization for Standardization established ISO 27000 series of standards in October 2005. These were standards for providing guidelines of security management for protection of organizational information assets. ISO 2701:2005 was the first standard floated in this series. In order to address the dynamically changing scenarios of information security, this standard was subsequently upgraded first as ISO27001:2013 and then to ISO27001: 2017 in the years 2013 and 2017 respectively. ISO27001:2017 version has addition of service delivery section. Other domains and controls of 2013 have remained unchanged. This study analyses ISO 27001 controls for 2013 version and also their applicability in processes, for effective enterprise risk management.

### ISO27000:2013

**ISO 27001 encompasses following sections –**

- Risk Assessment
- Security policy
- Organization setup for security
- Management of assets
- Security in HR
- Environmental security and Physical security

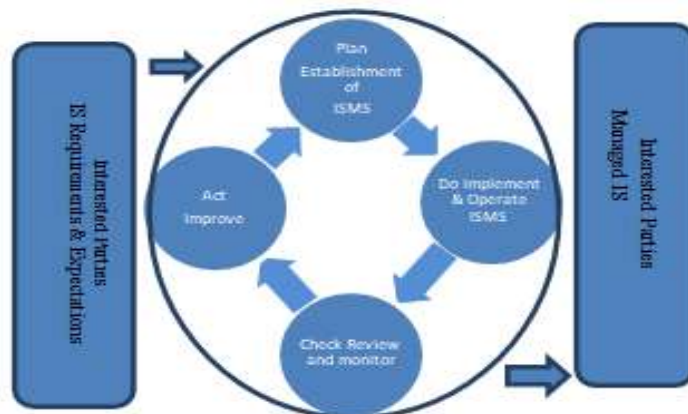
- Operations management
- Communications Management
- User access Management
- IS acquisitions, development & Maintenance
- Management of IS incidents
- Business Continuity and Disaster Recovery
- Compliances

Categorization of information security risks is the basis of this standard. This involves identification of different information security risks, estimating their probability & impact followed by selection and implementation of suitable mitigation methods.

**Following are the central principles of the ISO 27001 for information security management -**

- Management approved Comprehensive organizational security policy as major legal/regulatory requirement
- Impact of risk should be analysed to establish appropriate plan of mitigation to minimize the risks within tolerable limits.
- Developing business continuity plan and disaster recovery plan and its mock testing is essential. Both these plans should be regularly updated after review.
- The human and technology resources required for ISO 27001 implementation should be planned and provided. These human resources should be aware of the significance information security and capable to contribute to achieve the objectives of ISMS.
- As per ISO 27001 risk mitigation plan, IS policies, procedures should be are documented and communicated to all concerned to create a corporate IS culture.

The Process of implementation for ISO 27001 is depicted in Fig 1. It follows PDCA cycle which begins with the interested parties setting up the IS security requirements and expectations.



**Fig 1**

Each of the PDCA stages comprise of following sub-steps as indicated in Fig 2 -

- Step 1: Establish team for implementation
- Step 2: Development of plan for implementation
- Step 3: Initiation of ISMS
- Step 4: Scope definition
- Step 5: Deciding baseline for security
- Step 6: Setting up a process for risk management
- Step 7: Implement mitigation plan for identified risks



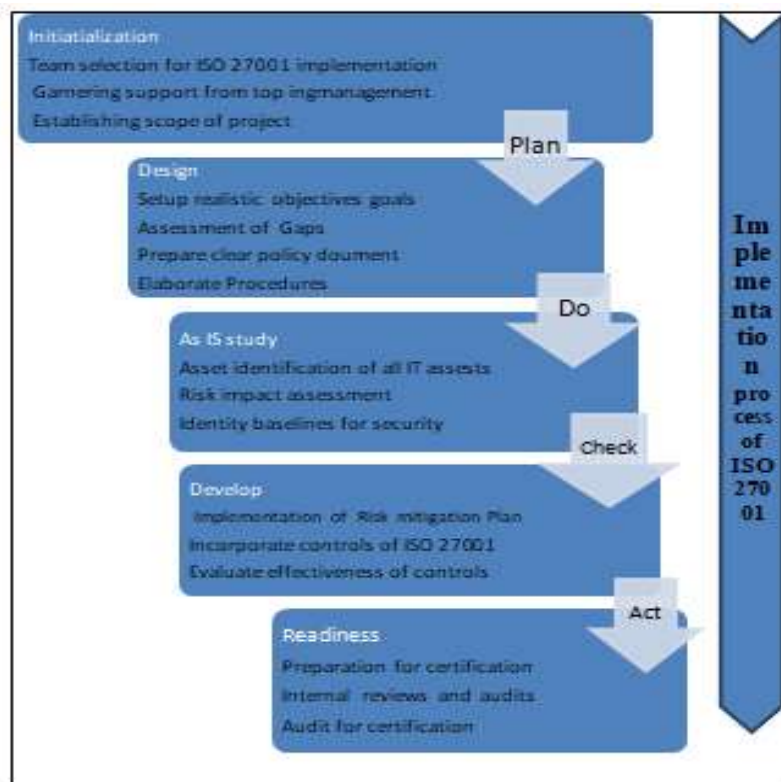


Fig -2

This study performs comparative analysis and identifies the key changes incorporated in the upgraded Standard ISO27001:2013 in comparison of 27001:2005.

These key changes in this 2013 ISMS version which relate to enterprise risk management function have been presented below -

**A. Stakeholders are given due importance (clause# 4.2)—**

ISO27001:2013 emphasizes on enlisting the expectations and requirements of all interested. This provides a participatory mechanism to all stakeholders for providing crucial inputs to the information security management system (ISMS). It further improves effectiveness of ISMS implementation in an enterprise. ISO/IEC 27001:2013 recognizes the importance of inputs from stakeholders such as government authorities, customers, shareholders, and associates.

**B. Concept of Risk Ownership ( clause# 6.1.2 and clause # 6.2) —**

The higher level management has been made responsible and liable, for various identified risks, by introducing “Risk Owner” term as against the earlier term as “Asset owner”.

By this approach, organizations can get flexibility of choosing and implementing suitable risk management tools or methods. Also, this risk owner approach will provide better alignment of the information security risk management processes with the activities of enterprise risk management of an organization.

**C. Significance of strategic risk—**

ISO 27001:2013 provides focus on strategic risk rather than emphasizing only on the technical risk or technology risk as was the case of ISO27001:2005. In this process, organizations should explore and identify new domains as opportunities and make plans to realize them. The potential impact of inappropriate strategy or lack of responsiveness to changes in demand are strategic risks. ISO27001:2013 provides improved ISMS which enables enhanced support to the organizations to do things in a more secured way than ISO27001:2005. .

**D. Enhanced control of executive management by continuous monitoring (clause # 5.1) —**

ISO 27001:2005 provided for general management oversight over the information security controls, however ISO 27001:2013 has focusses on the importance of having a well-defined plan for monitoring exact processes and controls through introduction of stringent rule-based sections. Mechanism to setup objectives, processes and process owners, periodicity and method of evaluation are defined by these rules. These provisions in this standard are expected to align ISMS with other processes of enterprise management including Enterprise Risk management.

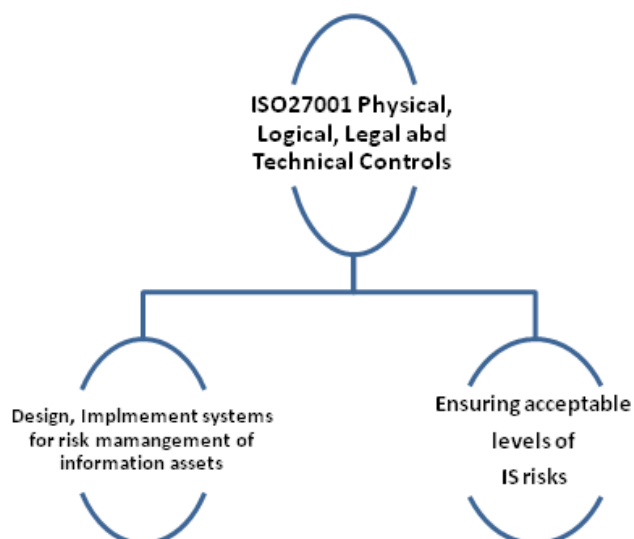
**E. Risk management methodology introduced (clause 6.1.2)—**

ISO 27001:2013 guidelines help in providing improvement in confidentiality, integrity, and availability factors. ISO2700:2005 focused primarily on IT assets, vulnerabilities, and threats. This approach using CIA triad will provide organizations choice of deciding methodology to achieve CIA rather than identifying vulnerabilities, threats etc, for individual assets. This revised standard provides option of ensuring CIA for organizational information security, thereby reducing the load of asset-based assessment of vulnerability and threat. This will enable organisations to have greater flexibility in IS risk assessment. It will also give insights about the strategic risks in addition to technical risks which are associated with the information assets. ISO 31000 risk management standards has been setup on 8 principles which are based on value creation and its protection and the same is the basis for each of the components of this standard including framework, control objectives and processes.

**The Principles of ISO 31000 are provided below:**

- Integration of Risk management into different processes of organization
- Risk management is comprehensive and structured
- Customization of risk management is necessary depending upon the type of organization.
- Risk management should be all-encompassing
- Risk management should be flexible and should respond to changes.
- Risk management should be based on authentic factual information.
- Risk management considers organizational culture and human factors
- Risk management emphasizes on continual improvement.

By mapping these principals with control objectives of ISO 27001 of the enterprises can align the function and processes with ERM activities as depicted below -



**Fig:** Mapping of ISO 27001 and ERM ISO 31000 for risk assessment processes

**F. Information dissemination to all concerned about information security (clause 7.4)**

There has been a problem related to information security in that it is being treated as IT entity. In ISO27001:2005, there was no emphasis on organization wide communications relating to the information security implementation in the organization. ISO27001:2013 provides specific clause which summarizes the communication requirements such as “what should be communicated, the process owner for communications, method of communication, choice of channel etc.

**G. Changes in the controls and control sections**

ISO27001:2013 has modified many controls. There is increase in set of required documents and exclusion of some unnecessary documents. ISO27001:2013 has 114 controls as compared to 133(Table 1) controls of ISO27001:2005.

**Table -1** Security Controls introduced by ISO-27001:2013

Control Section "A" Subsections are listed below	Description
6.1.1	IS in Management of projects
14.2.1	Policy for secured development
14.2.5	Secure system engineering principles
14.2.6	Policy for secured environment for environment
14.2.8	Testing for information security
16.1.4	Events assessment and making of decision Information security security events
17.2.1	Availability of infrastructure for information processing

In ISO 27001:2013, the numbers of sections have been increased to 14 from

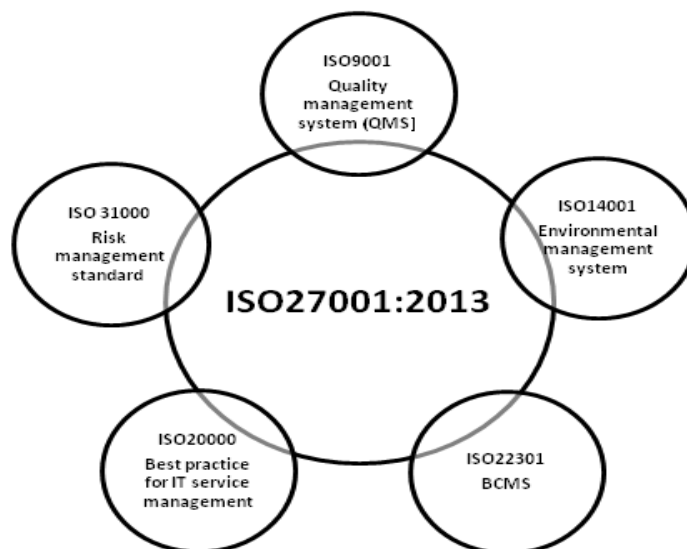
11, in ISO27001:2005 (Table 2). The structure of controls has been reorganized to make them suitable for implementation.

**Table -2** – Comparative analysis of Count of Controls

Annex A	ISO 27001:2005	ISO 27001:2013
Sections	11	14
Controls	133	114

#### Alignment with Global Standards & Frameworks

ISO27001:2013 is synchronized with almost all globally recognized comprehensive standards practiced for management in different types of industries (Fig 3). It can be noted that this standard has built in alignment enterprise risk management (ERM) practices with the information security management.



**Fig – 3** – Compatibility of ISO27001 with other management standards

#### ISO27001:2013 deployment benefits

Implementation of this updated provides has following advantages:

- **Provides better governance for enterprise** - It has been mandated by ISO27001:2013 that corporate governance should reduce the financial risks of an organization, owing to information systems. Implementation of ISO27001 can help organisations satisfy this requirement.

- **Alignment with ERM**— ERM processes and activities have been incorporated in control objectives of ISO 27001 :2013 information security risk management standard. Hence implementation of ISO 27001 would help in mitigating enterprise risks.
- **Prevention from cybercrime**— Implementation of the IS processed as per ISO 27001 ISMS would improve cyber resilience of the enterprise and that will help protect businesses from the cyber threats.
- **Enhanced protection from cyber incidents and cyber accidents** – Control objectives of ISO27001 provide stringent guidelines for Incident Management and Business Continuity Plan. Therefore, organisations are better protected for data loss and business disruptions by implementing ISO27001:2013.

## CONCLUSION

This paper presents explores areas of alignment between information security with ISO31000, the standard for enterprise risk management. It also provides comparison of the ISO27001:2013 with ISO 27001:2005, and highlights the additional areas covered by this standard.

The paper analyses the key requirements of ERM in view of the increased threats to information assets, expectations of stakeholders and regulatory requirements.

Integrating the control objectives of ISO27001:2013 with the ISO31000 processes for ERM, would enable organizations to have better management control while having appropriate practices for risk assessment. The suitably adapted ISM implemented effectively can be extended to cater to requirements of Enterprise Risk Management ISO31000.

This would effectively result in improving governance practices and process including ERM and IS functions. Organizations need to undertake thorough analysis and confirm this alignment to extract maximum benefits.

## REFERENCES

1. <https://www.iso.org/files/live/sites/isoorg/files/store/en/PUB100426.pdf>
2. <https://www.iso.org/obp/ui/#iso:std:iso:31000:ed-2:v1:en>
3. Does ISO 27001 Certification Make You NIST Cybersecurity Framework Compliant? Information Security Blog, [www.pivotpointsecurity.com/risky-business/iso-27001-nist-cybersecurity-framework-compliance](http://www.pivotpointsecurity.com/risky-business/iso-27001-nist-cybersecurity-framework-compliance)
4. International Organization for Standardization (ISO), ISO 27001:2013 Information technology-Security techniques. Information security management systems— Requirements, 2013
5. ISACA, COBIT Process Assessment Model(PAM): Using COBIT 5, 2013, [www.isaca.org/cobit](http://www.isaca.org/cobit)
6. ISACA, COBIT 5, USA, 2012, [www.isaca.org/cobit](http://www.isaca.org/cobit) p.13-33
7. ISACA, The Business Case Guide: Using Val IT 2.0, USA, 2010, [www.isaca.org](http://www.isaca.org)
8. ISO/IEC27001, ISO/IEC 27001:2005, Information Technology, Security techniques, Information security management systems requirements. Geneva: International Standard Organization, 2005

## Development of Hybrid Model for Predicting Dengue and Viral Proteins in Its Genome

**Brijesh D. Mehta**

D.T.M.T, M.Sc. (I.T.), Ph.D, UCCC & SPBCBA & SDHGBCA & IT, Udhna, Surat, India

### ABSTRACT

Dengue fever is the most common. Mosquito-borne viral sickness of humans that during current years has end up an essential global public fitness issue. The scientific manifestations of fever resemble the ones of dengue fever and so have to be prominent from dengue fever. Co-occurrence of each fever has been observed in Gujarat state of India for that reason highlighting the importance of sturdy clinical suspicion and efficient laboratory aid. Hence the shaped using of Hybrid Model created and will assist people to stumble on if they're infected by dengue or not. This could additionally help the doctors, to diagnose the sufferers and provide the proper remedy. Protein-Protein Interaction (PPI) is crucial for deciphering the function of Virusproteins. Dengue has ten viral proteins in its genome. We have here discussed the machine learning approach for the classification of dengue patients.

Keywords: Relief Filter, C4.5 Classification, FFBPNN, Firefly Algorithm.

### INTRODUCTION

Protein-Protein Interaction (PPI) is essential for understanding how virus proteins work. Dengue virus' genome contains 10 viral proteins. The Dengue virus interacts with human protein via PPI. DENV-1, DENV-2, DENV-3, and DENV-4 are the four viral serotypes that cause dengue disease [1]. Some of the interactions between dengue and human proteins are influenced by serotype. Many investigations concentrated on serotype-specific studies, confirming that the DENV-2 and DENV-3 serotypes are fatal. DENV DB, DEnvirDB, Flavitrack, Dengue Info, Virus Mentha, and VirHostNetet [1] are some of the databases that store dengue-related data. The most difficult task facing the pharmaceutical industry is matching a new medicine to a specific dengue protein target. The fundamental purpose of Computer-Aided Drug Design (CADD) is to develop a new lead molecule that can subsequently be tested in both experimental and preclinical settings. CADD enables a medicine to be developed at a lower cost and in less time. Computational techniques to drug development give an excellent platform.

Serotype of human protein, type of interaction with dengue protein. All of the details in the dataset are adequate for both computational and biological purposes. The interaction between Dengue and human proteins is the focus of this investigation. In the dengue-human PPI, there are 535 non-redundant interactions between 335 different human proteins and 10 dengue proteins. Dengue proteins interact with human proteins in a serotype-specific manner, with serotypes specified for each interaction. The denhuman dataset was used to build an Artificial Neural Network (ANN) model to predict a new type of interaction between dengue and human proteins in this study. This work presents a hybrid technique that combines FFBPNN with the firefly algorithm to predict the dengue-human protein interaction.

### LITERATURE REVIEW

DENGUE is a frightening ailment spread by female mosquitos, according to P. SATHYA ANDA.SUMATHI. It's most common in hot, humid climates. Experts have been attempting to identify some of the characteristics of Dengue fever for a long time in order to correctly categorise patients, as different people require various types of therapy. Since a few years, Pakistan has been focusing on Dengue fever. Dengue fever is a disease that is used to evaluate clustering techniques.

WIWIK ANGGRAENIA ET AL. (2017): To estimate the number of Dengue fever attacks in Malang Regency, Indonesia, this study used a regression technique with Least Square and Natural Logarithmic transformations in response variables. Weather was a factor in the prognosis. The weather element was determined to be the most influential among the eight models that were created. To determine the relevance of the model found, some tests were used, including a hypothesis test. When compared to models without transformation, the model utilising the response variable with logarithmic natural transformation performed better. It was backed up by the model 96's average MAPE of less than 10%. As a result, it was discovered that the regression approach works best when the variances of the dependent and independent variables are roughly similar, allowing the dependent variables' variability to be well described by the independent variable.

Dengue viruses, which infect millions of people globally each year, generate major epidemics that put a strain on healthcare systems. MICHAEL A. JOHANSSON ET AL (2016): Despite various efforts to construct forecasting tools such as autoregressive time series, climate-driven statistical models, and mechanistic biological models, little research has been done to investigate the contribution of different components to enhanced prediction.

## METHODOLOGY AND DISCUSSION:

### a) Relief Filter Approach

The dengue-human protein interaction is classified using deep FFBPNN, a supervised machine learning technique. Relief filter aids in the filtering of specific attributes from the entire dataset in order to improve the FFBPNN algorithm's performance. It calculates the weights of the attributes based on the distance between instances, with the weights ranging from -1 to 1. Because it is simple, rapid, and smart feature selection for calculating the weights of attributes, Relief offers intelligibility in improving FFBPNN as well as minimizing training time. The attributes with the highest weights are chosen for further training of the algorithm, which improves the model's accuracy.

### b) C4.5 Classification

In order to solve problems in the medical field, C4.5 decision tree classification is being implemented. Quinlan developed an enhanced version of the ID3 algorithm. The algorithm uses a recursive top-down approach to build the decision tree (otherwise called as divide and conquer method). To construct the tree, it uses the feature selection of information gain as a splitting condition. The attribute with the most information serves as the tree's root node, with the remaining attributes following in its footsteps. It eliminates missing values and unwanted branches, thereby improving the classification performance of the C4.5 tree.

### c) FFBPNN

To train the deep learning network, the filtered normalized data is fed into the FFBPNN. A neural network is made up of three layers: one input, one hidden layer, and one output layer. Deep learning is made up of many hidden layers, each of which is completely connected to the next layer via weighted edges. Deep FFBPNN is another name for this technique. Forward propagation is the process of processing data from the input layer to hidden layers and then to the output layer. The activation function is propagated to the next layer after the sum of the weight is applied at each layer, which is calculated using the gradient descent approach. When using FFBPNN, increasing the hidden layers can make determining weights more difficult. As a result, the classification error is reduced. As a result, the neural network requires adjusting the edge weights to obtain optimal weights.

### d) Firefly Algorithm

The firefly algorithm (FFA) is inspired by firefly behaviour and flashing patterns. The goal of FFA, also known as metaheuristic optimization, is to discover the best solution to a problem. Its primary purpose is to ensure that the following guidelines are followed: 1. Because fireflies are unisex, each species can attract all other fireflies. 2. The appeal of lightning should be proportionate to its brightness; if two beings are of equal brightness, the lower-brighter creature will always move to the higher-brighter creature. As the common distance rises, the perceived brightness of the firefly drops. 3. The fireflies travel around at random, hunting for other fireflies instead of the one they're looking for.

```
Function Firefly  
Objective function  $f(X)$ ,  $X=(x_1, \dots, x_d)$   
Generate an initial population of fireflies  
Evaluate light intensity  $I_i$  for firefly at  $X_i$  by using  $f(X)$  for all fireflies  
Iteration=1;  
While (Iteration <= max_iteration)  
{  
  For (i=1; i <= population_size; i++)  
  {  
    For (j=1; j <= population_size; j++)  
    {  
      If ( $I_i > I_j$ ) Move firefly i towards j in d-dimension;  
      Attractiveness varies with distance r via  $\exp[-r]$ ;  
      Evaluate light intensity of new solutions;  
    }  
  }  
  Update current best solution;  
  Iteration++;  
}  
Return current best solution;  
End Function
```

Figure-1 Pseudocode for Firefly Algorithm

The goal function's brightness should be proportional. The calculation compares the new and previous firefly positions in terms of their attractiveness. If the new position provides more appeal, the firefly is transported to it; otherwise, it remains in its existing position. FFA successfully selects the FFBPNN's ideal weights in this study, resulting in an increase in the network's hidden units.

The combination of FFBPNN with FFA yields a well-designed model for improved dengue-human protein interaction prediction, according to A Proposed Approach to Optimized FFBPNN. Because certain activation functions that are put into neural networks process several hidden layers, training the network is difficult.

FFA is internally combined with the neural network to improve the network's functionality, resulting in fine prediction [3]. Deep FFBPNN parameter optimization is done completely with FFA. FFA adjusts the weights in order to reduce mistake and improve accuracy. The proposed model's functionality is depicted in Figure 2.

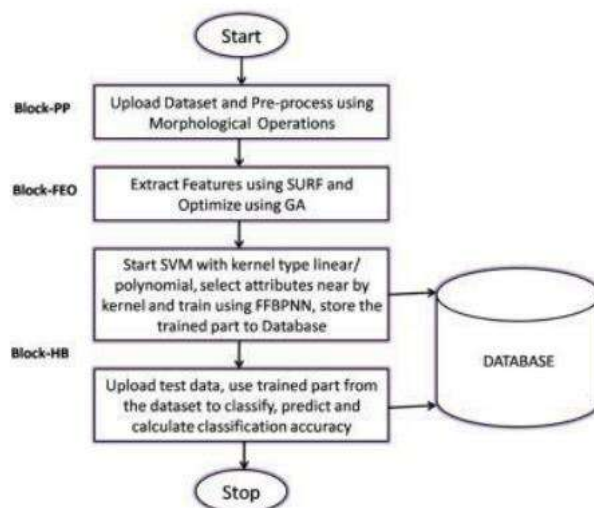


Figure 2: The operation of the proposed model.

The Denhuman training set is used to train the FFBPNN - FFA algorithm using 70% of the observations, while the remaining 30% is used to forecast the proposed algorithm's accuracy and error rate [3]. The proposed optimised FFBPNN has been built and shown in Figure 3.

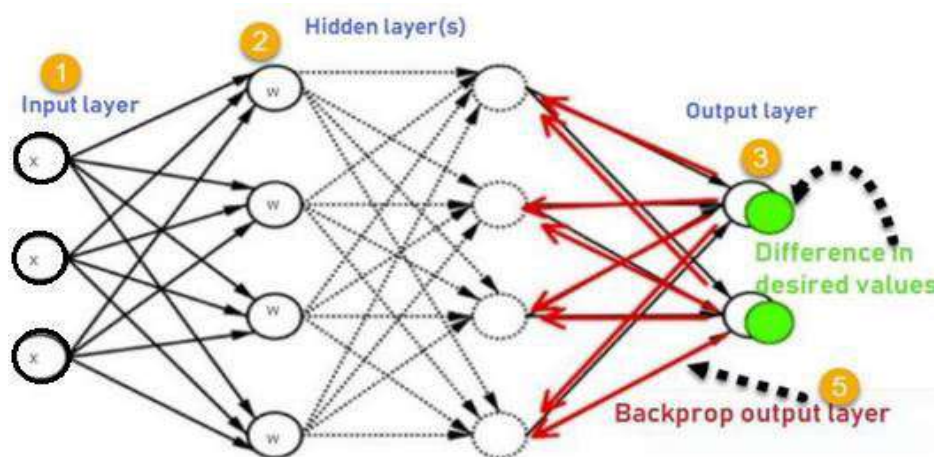


Figure-3 Optimized FFBPNN

A complete examination of the number of dengue-human interactions with the related serotypes DENV1, DENV 2, DENV 3, DENV 4, and a subset of serotypes is shown in the picture. Manually retrieved from the denvInt dataset are the number of interactions and serotypes. A significant number of human proteins are thought to interact with Dengueserotype 2.

## CONCLUSION

In a range of health-care applications, machine learning algorithms can be utilised to diagnose, forecast, and predict. To help make better decisions, the model assists in the extraction of previously unnoticed features and relationships from data. Traditional machine learning methods can be improved with optimization techniques to

lower network error rates. In this study, a hybrid model that combines FFBN with the firefly optimization technique is developed to predict the dengue human protein interaction. This study's hybrid model classifies the numerous forms of interactions between dengue protein and human protein. Interactions between dengue and human proteins are serotype-specific, and additional research is needed to establish this. The proposed hybrid model has a high degree of accuracy, indicating that forecasts are more accurate than the actual value. Implementing the FFBN-FFA model, as a result, will aid in the development of antiviral medications.

#### **ACKNOWLEDGEMENT**

I would like to thank my institute for providing me such a big opportunity in my life. Moreover, I would like to thank God for all that it has given to me. I also would like to thank those who have helped me directly or indirectly.

#### **REFERENCES**

1. GLASNER, D. R., PUERTA-GUARDO, H., BEATTY, P. R., & HARRIS, E. (2018). The Good, the Bad, and the Shocking: The Multiple Roles of Dengue Virus Nonstructural Protein 1 in Protection and Pathogenesis. *Annual Review of Virology*, 5(1), PP 227–253. <https://doi.org/10.1146/annurev-virology-101416-041848>.
2. PRIYANKA SHARMA (2013) Decision Support System for Malaria and Dengue Disease Diagnosis (DSSMD). *International Journal of Information and Computation Technology*, 3(7), PP 633–640.
3. KOMAL MINHAS (2020) Accurate Pixel-Wise Skin Segmentation Using Shallow Fully Convolutional Neural Network. *IEEE Access*, 8, 156314–156327. PP 137-248 <https://doi.org/10.1109/access.2020.3019183>



---

---

## Artificial Intelligence and Machine Learning Prospects for Banking Risk Management

Deepa Honrao<sup>1</sup> and Yashwant Patil<sup>2</sup>

<sup>1</sup>MCA, DES's NMITD (Affiliated to University of Mumbai, India)

<sup>2</sup>Center Information Technology, VAMNICOM (Affiliated Savitribai Phule Pune University, India)

### ABSTRACT

The current technological advances with social, mobile, analytic and cloud(SMAC) technologies are going hand in hand, paving the way to the future with intelligent machines, huge data, and networked processes. Artificial intelligence(AI) and machine learning(ML) applications are keen on this and have shown an upward trend in solving real-world problems scientifically. AI and ML has many potentials for use in Finance and Banking. In banking it has been commonly used for making informed decisions, customer segmentation, forecasting account closures, analyzing customer spend patterns and managing risk. The remarkable increase in the volume of transactions, a high degree of operational changes, and complex systems managing risks are becoming an important aspect of comprehensive risk management practices in current financial markets. Since the global financial crisis, there has been a constant focus on risk detection, measurement, management, and reporting, giving more prominence to the risk management function of banking.

Keywords: Banking Risk Management, Artificial intelligence, Machine Learning, Risk Management tools.

### 1. INTRODUCTION

Every country's financial system relies on banks to mobilize deposits from individuals all around the country and make them available for investment, lending, and the purchase of assets. Banks act as intermediaries between fund suppliers and fund consumers, allowing enterprises and governments to operate. Banks operate in a complex environment with stringent regulatory/compliance requirements, high competition, demanding customers, and risk. Public sector banks, private sector banks, and cooperative banks are the three types of banks in India. As per RBI, there are 2092 active banks in India fulfilling urban and rural financial requirements [1].

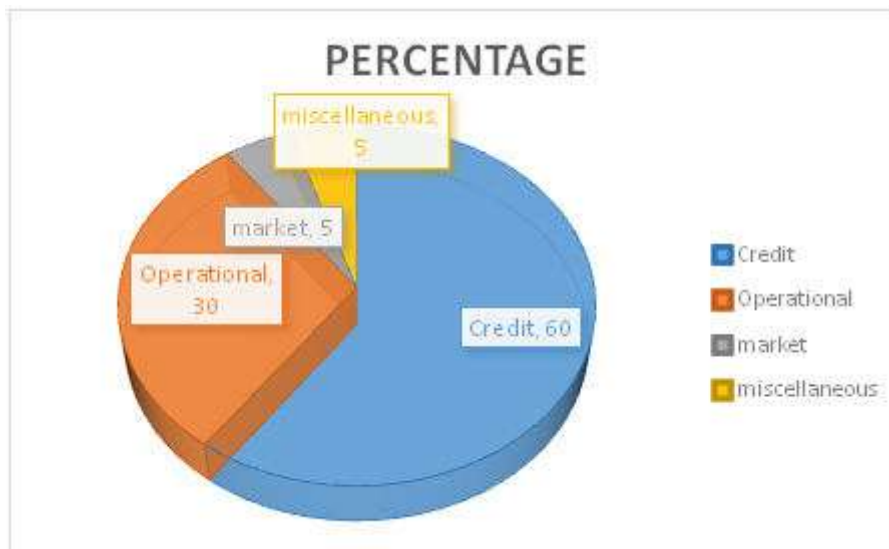
Banks have to operate with overwhelming customer needs, hence there is a high chance of slipping into the trap of fraudsters. Risks are broadly defined as "Uncertainties potentially resulting in adverse variation of profitability or losses" [2]. Risk is many times considered synonymous with uncertainty, but the two are unlike, uncertainty denotes randomness and risk refers to adverse effects on wealth caused due to outcomes. Banking regulatory organizations and capital charges levied against risks have a significant impact on the risk modeling process in banks.

As mentioned by N. Milojevic and S. Redzepagic, AI can be defined as "The theory and computer system progress which is capable of conducting assignments and solve problems that usually need human intelligence as the prerequisite" [10]. Machine learning is a sub-branch of AI. Machine learning trains machines to process data and analyze data, learn from it and make decisions based on stated experience. Applications of AI and ML in the financial domain are constantly increasing. One of the areas of finance- risk management in banking has undergone the most significant advancement in recent decades, but demand for further development is constantly increasing. This research work focuses on AI and ML prospects towards banking risk management, with Section 2 analyses the characteristics of banking risk management, section 3 details AI and ML technology, section 4 focuses on applications of AIML for banking risk management, section 5, concludes the paper with prospects in a nutshell and future research that can be taken.

### 2. The current banking risk management characteristics

Banking activities are critical to achieving the Bank's goals and maintaining its financial strength and independence. To have a competitive edge over others and to maximize their profits, banks get tempted to take higher risks, which increases the chance of banks falling prey to fraudsters. Banks are required by regulators to have capital provisions for a variety of risks. Risk management takes up a significant percentage of bank resources. Banks need to be very vigilant when planning for risk mitigation. Risks in the banking sector are broadly classified as Financial Risks and Non-Financial risks. The Financial Risks have monetary or financial losses, whereas Non-Financial risks do not bring a direct impact on financials, but they bring in indirect losses. Credit risk, Liquidity risk, Principal risk, and market risk, are part of Financial risk, while Compliance risk, Legal risk, Reputational Risk, Country Risk, model risk, conduct risk, Business & Strategic Risk, Strategic

Risk, and Operational risk are part of Non-financial risk [6]. Credit risk is a big concern for banks, as it has a high chance of capital losses, and hence requires immediate attention. Bank trading operations are related to market risk. Operational risk, on the other hand, is the risk posed by internal system failures or external occurrences. Of the total risk portfolio of a bank 60% is for Credit risk, 30% is for Operational Risk, 5% is for market risk, and the remaining 5% is for miscellaneous risks [4]. The same is depicted pictorially in Fig1



**Fig1.** Risk management portfolio of banks

The most frequent risks are operational, market, and credit risks, but other types of risk include liquidity, business, and reputational risk. Banks take utmost care and efforts to manage, monitor, and measure these risks. [7]. Other risk categories, in addition to these four key risks, contribute to the bank's risk portfolio and necessitate banking resources to manage.

**Credit risk** - The single most significant risk that banks face is credit risk. [7]. It is defined as the risk that a bank will lose money if a borrower fails to repay the loan or credit card bill (principal and interest). The Basel Accord permits banks to use a Credit risk management strategy based on internal ratings. To calculate the expected loss, banks can construct their own credit risk models. Probability of default (PD), loss given default (LGD), and exposure at default is the essential risk parameters to estimate (EAD).

“  $P D \times L G D \times E A D = \text{Expected Loss}$ ” (Basel Committee on Banking Supervision 2005a, 2005b).

**Market risk** is defined as “the risk of losses resulting from market price volatility “[8]. Risk of rising interest rates, equities risk, commodity risk, and foreign currency risk are just a few examples of market risks. Interest risk is the risk of losing money as a result of interest rate changes. The possibility of a loss as a result of a decline in the price of a stock is referred to as equity risk. The risk that the value of a bank's assets or obligations will change due to fluctuations in the currency exchange rate is known as foreign exchange risk. Commodity risk refers to the risk of losing money if the price of the commodities you own falls. Hence Market risk can also be termed as the risk of volatilities.

**Liquidity risk** - There are two categories of liquidity risk: asset liquidity risk and funding liquidity risk, which are managed separately from the other risks. When a transaction cannot be completed at the current market price, a bank risks asset liquidity, which could be due to the position's size relative to the typical trading lot size it is known as asset-liquidity risk. The failure to meet cash flow obligations is also known as funding liquidity risk. To offer appropriate liquidity and the ability to resist a variety of stress scenarios, banks must have a strong liquidity risk management strategy in place. Liquidity risk must be identified, assessed, monitored, and mitigated using a strong plan. (Basel Committee on Banking Supervision 2008).

**Operational risk** as defined by the Basel Committee on Banking Supervision (2001) [5] is the risk of direct or indirect losses resulting from insufficient or failed internal processes, people, systems, or external events. These operational risk events as classified by the Basel Committee on Banking Supervision (BCBS) (2001) are “ (1) internal and (2) external fraud, (3) employment practice and workplace safety, (4) clients, products, and practices, (5) damage to physical assets, (6) business disruptions and system failures and execution, and (7) delivery and process management.” .It is regarded as one of the non-financial dangers. Fraud risk, cyber security risk, money laundering risk, resiliency, financial crime risk, technology risk, vendor and outsourcing

risk, and business disruption risk are among the various forms of risk covered. Legal and compliance concerns are also mentioned as operational risks in some publications.

The detailed taxonomy of risks is mentioned below in Fig 2.

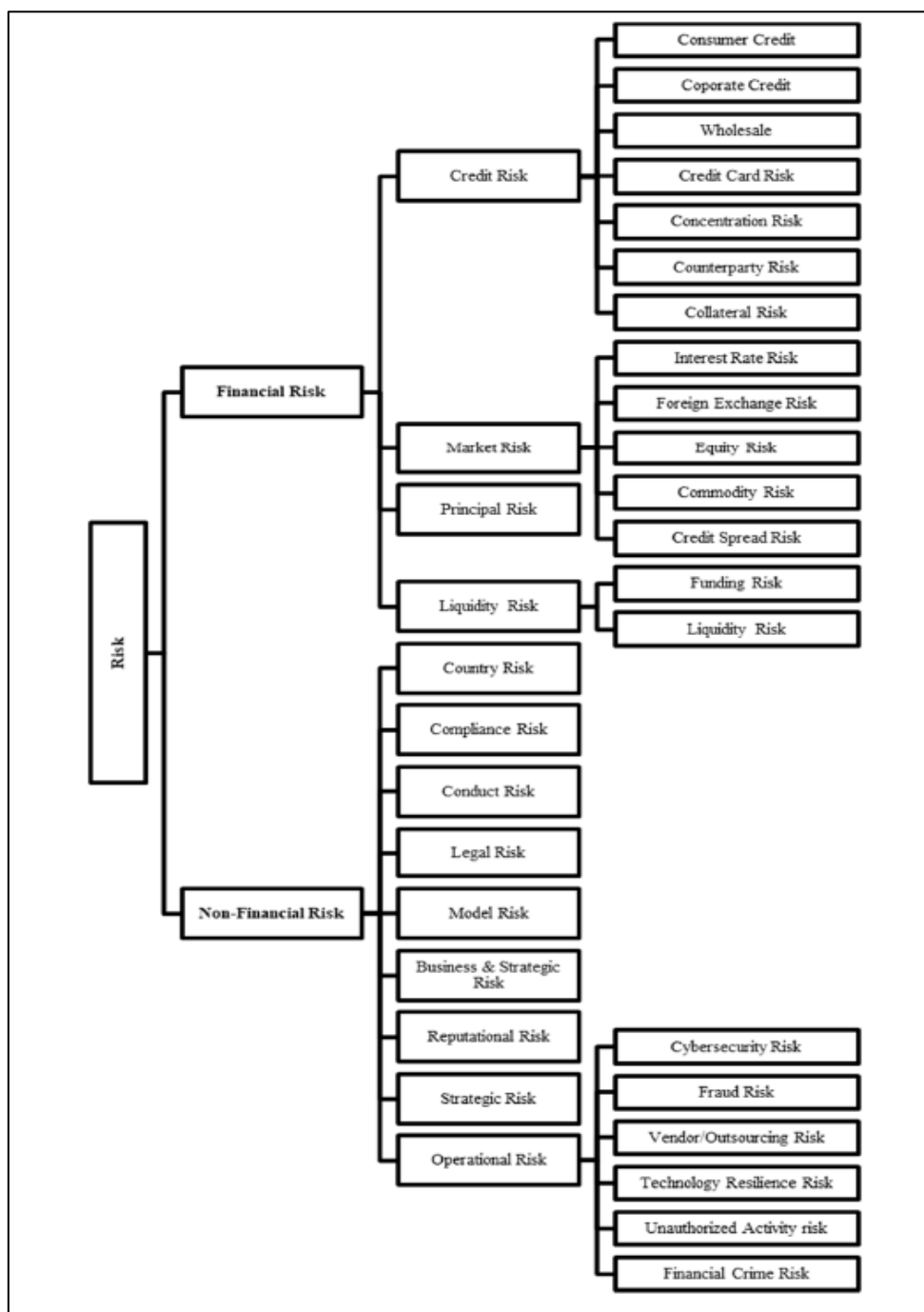


Fig2 Taxonomy of Risk [6]

### 3. Artificial intelligence and machine learning

AI as defined by Schalkoff, 1990[3] is “A field of study that seeks to explain and emulate intelligent behavior in terms of computational processes.” At the very fundamental level, Machine learning (ML) is a subfield of artificial intelligence that allows computers to think and learn on their own.

ML has been formally defined by researchers in the relevant literature. In 1959, Arthur Samuel coined the phrase “Machine Learning”, which he defined as “a field of research that gives computers with learning capabilities without being expressly programmed” [4]. Tom Mitchell recently proposed a “well-posed” formulation for engineering setup that has proven to be more effective: “A computer program is said to learn from experience E concerning some task T and some performance measure P, if its performance on T, as

measured by P, improves with experience E [5]. "The primary focus of ML is on developing computer programs that can access data, recognize patterns in the data and learn from the data.

Unsupervised and supervised learning are the two broad kinds of machine learning. When machines are trained on known input and output data to predict the future is called supervised learning and in supervised learning, machines are trained to find hidden patterns or inherent structures in data. Table 1 lists the categories of machine learning methods

Problem Type	Linear methods	Non-Linear methods
		Penalized Regression
Supervised Regression	<ul style="list-style-type: none"> <li>Principal Components</li> <li>Ridge</li> <li>Partial least squares</li> <li>LASSO</li> </ul>	<ul style="list-style-type: none"> <li>LASSO</li> <li>LARS</li> <li>Elastic nets</li> </ul>
		Neural networks and deep learning
Classification	Support vector machines	Decision trees:
		<ul style="list-style-type: none"> <li>Classification trees</li> <li>Regression trees</li> <li>Random forest</li> </ul>
		SVM
		Deep learning
Unsupervised Clustering	Clustering methods: K- and X-means, hierarchical principal components analysis Deep learning	

**Table 1.** Categories of Machine Learning techniques [28]

#### 4. Applications of AI and ML in Banking Risk Management

The application scope of A.I. and ML is expanding every day as financial institutions are adopting these two technologies at a rapid pace to solve a variety of issues. Besides in other sectors of banking AI & ML have

Risk Type	Risk Sub Type	Risk Method/ Tool	AI/ML Technique used	Description	Researcher
Credit risk	Consumer credit	Risk Monitoring	Decision tree and SVM	In the area of consumer lending and SME lending using decision tree and SVM to reduce costs by up to 25%	Khandani et al [9]
	Corporate credit	Risk Monitoring	Multivariate outlier detection	Improved credit-risk estimation for SME lending	Figini et al. [13]
	Credit Card risk	Scoring Model	SVM	For classifying credit card customers who default	Bellotti et al [14]

made their presence felt in risk management by providing effective and efficient solutions. Regardless of the firm's size, history, profile, strategy, degree of market development, local or global focus, or level of risk management complexity, AI and ML applications for risk management in banking are viable. The existing and emerging challenges in banking and risk management seem to be the subject of extensive research in both the scientific and industrial communities. Table 2 lists various risks and the AI ML techniques proposed by researchers to mitigate them.

	Concentration risk	Stress testing	Bayesian Networks	The idea of using probabilistic graphs for modeling and evaluation of credit concentration risk. Bayesian networks are used for the estimation of risk losses due to changes in debtors' economic condition	Pavlenko et al [15]
	Consumer credit	Scoring Model	Lasso Logistic regression	Using lasso logistic regression ensembling for evaluation of credit risk by using clustering and bagging algos to diversify and balance data, has outperformed previous techniques of risk evaluation.	Wang et al [16]
	Consumer credit	Exposure (PD, LGD, EAD)*	Bayes classifier, Nearest neighbor, ANN, Classification trees	Techniques such as logistic regression, ANN, nearest neighbor, Bayes classifier, and discriminant analysis were employed in a comparative study to estimate the accuracy of Probability of Default (PD) for credit rating of clients. ANN is the most accurate.	Yeh et al [17]
Market Risk	Interest rate risk	Value at Risk	Cluster analysis, Gaussian Mixture Method	The "Gaussian Mixture model" method of clustering can be used to monitor Interest rate risk giving better visualization of the Interest rate curve.	Kanevski et al[18]
	Equity Risk	Value at Risk	Cluster analysis	The value at risk forecasting can be done using cluster	Mahdavi-Damghani et al [20]

				analysis for the stochastic differential equation.	
	Equity Risk	Value at Risk	GEM	A model based on generalized extreme machine learning to estimate volatility in market risk	Zhang et al.[21]
	Equity Risk	Value at Risk	NEURAL NETWORK	Using a neural network to improve volatility estimation models.	Monfared and Enke [19]
Liquidity risk	Liquidity risk	Risk Limits	SVM	Use of vSVMs for risk minimization through Conditional Value at Risk minimization	Gotoh et al [22]
	Liquidity risk	Scoring Models	ANN, Bayesian Networks	For estimating the chance of an event occurring, a functional approximation and a distributional estimation utilizing ANN and BN are used to evaluate risk.	Tavana et al [23]
Operational Risk	Fraud risk	Risk Monitoring	Logistic regression	Use of logistical regression algorithms for suspicious transaction detection.	Khrestina et al[24]
	Fraud risk	Risk Monitoring	Cluster analysis	Use of clustering algorithms to detect behavioral patterns in people and trace them using transaction history	Sudjianto et al [25]
	Fraud risk	Risk Monitoring	C5.0	Based on different probable risk factors rules set can be formed and cluster allocation can be done using the C5.0 algorithm	Villalobos et al [26]
	Fraud risk	Risk Monitoring	K nearest neighbors(KNN), Support vector machines, Bagging ensemble, and	Given a transaction dataset, various algorithms can be used to predict the probability of	Zareapoor et al [27]

			Bayesian Algorithms	fraud. The bagging ensemble classifier has given near-accurate results.	
	Cybersecurity Risk	Risk Assessment	Non-linear clustering method	The unsupervised Non-linear clustering methods were used to group cybercrime event data	Peters et al [28]

\*PD- the probability of default, LGD- loss given default, EAD- exposure at default

**Table 2.** AI-ML applications for mitigating various Risk types

## 5. CONCLUSION

The current global financial crisis has resulted in significant changes in the banking industry. Technological advances are reshaping the modes of financial transactions. These advances are making financial systems more vulnerable. The Regulatory bodies, financial experts, and scientific community are working hard to mitigate the risks. Artificial intelligence and machine learning are having a greater impact in the financial sector, particularly in risk management in banks. Credit risk is the very prominent risk of the risk portfolio, substantial research has been done to mitigate credit risk and its types using AI-ML techniques. Also measured and well-prepared AI ML applications bringing in a positive impact on other risk management areas:- market. Liquidity, Operational risk, as well. This research also highlights further prospects of AI ML applications in newly evolved risk areas(IT, Cyber Security). Some of the prominent challenges in this area are data availability, privacy protection, transparency, availability of skilled staff, and ethics. AI ML applications have predominantly brought higher accuracy at efficient time values.

## REFERENCES

1. RBI Docs- Banks in India <https://m.rbi.org.in/commonman/english/scripts/banksinindia.aspx>Asdasd
2. Bessis, J. (2011). Risk management in banking. John Wiley & Sons.
3. Stuart J. Russell and Peter Norvig(1995), Prentice-Hall ISBN 013-103805-2
4. Samuel AL. Some studies in machine learning use the game of checkers. IBM Journal of research and development. 1959 Jul;3(3):210-29.
5. Mitchell, T. (1997). Machine Learning. McGraw Hill. p. 2. ISBN 978-0-07-042807-2
6. Leo, Martin, Suneel Sharma, and Koilakuntla Maddulety. "Machine learning in banking risk management: A literature review." Risks 7.1 (2019): 29.
7. Apostolik, R., Donohue, C., & Went, P. (2009). Foundations of Banking Risk: An Overview of Banking, Banking Risks, and Risk-Based Banking Regulation, Hoboken/New Jersey.
8. Jorion, Philippe. 2007. Value at Risk: The New Benchmark for Managing Financial Risk. New York: McGraw-Hill.
9. Khandani, A. E., Kim, A. J., & Lo, A. W. (2010). Consumer credit-risk models via machine-learning algorithms. Journal of Banking & Finance, 34(11), 2767–2787.
10. N. Milojevic, S. Redzepagic(2021) Prospects of Artificial Intelligence and Machine Learning Application in Banking Risk Management, Journal of Central Banking Theory and Practice, 2021, 3, pp. 41-57
11. Aldasoro, I., Gambacorta, L., Giudici P. and Leach T. (2020). Operational and cyber risks in the financial sector. Bank for International Settlements, BIS Working Papers No 840, February 2020
12. Financial Stability Board (2017). Artificial Intelligence and Machine Learning in Financial Services, Market Developments, and Financial Stability Implications. November 2017, Retrieved from: <http://www.fsb.org/2017/11/artificial-intelligence-and-machine-learning-in-financial-service/>

13. Figini, S., Bonelli, F., & Giovannini, E. (2017). Solvency prediction for small and medium enterprises in banking. *Decision Support Systems*, 102, 91-97.
14. Bellotti, T., & Crook, J. (2009). Support vector machines for credit scoring and discovery of significant features. *Expert systems with applications*, 36(2), 3302-3308.
15. Pavlenko, Tatjana, and Oleksandr Chernyak. 2009. Bayesian Networks for Modeling and Assessment of Credit Concentration Risks. International Statistical Conference Prague. Available online: [http://www.czso.cz/conference2009/proceedings/data/methods/pavlenko\\_paper.pdf](http://www.czso.cz/conference2009/proceedings/data/methods/pavlenko_paper.pdf) (accessed on 21 July 2018).
16. Wang, H., Xu, Q., & Zhou, L. (2015). Large unbalanced credit scoring using lasso-logistic regression ensemble. *PloS one*, 10(2), e0117844.
17. Yeh, I. C., & Lien, C. H. (2009). The comparisons of data mining techniques for the predictive accuracy of probability of default of credit card clients. *Expert systems with applications*, 36(2), 2473-2480.
18. Kanevski, M. F., & Timonin, V. (2010). Machine learning analysis and modeling of interest rate curves. In *ESANN*.
19. Monfared, S. A., & Enke, D. (2014). Volatility forecasting using a hybrid GJR-GARCH neural network model. *Procedia Computer Science*, 36, 246-253.
20. Mahdavi-Damghani, B., & Roberts, S. (2017). A proposed risk modeling shift from the approach of the stochastic differential equation towards machine learning clustering: Illustration with the concepts of anticipative & responsible VaR. Available at SSRN 3039179.
21. Zhang, H. G., Su, C. W., Song, Y., Qiu, S., Xiao, R., & Su, F. (2017). Calculating Value-at-Risk for high-dimensional time series using a nonlinear random mapping model. *Economic Modelling*, 67, 355-367.
22. Gotoh, J. Y., Takeda, A., & Yamamoto, R. (2014). Interaction between financial risk measures and machine learning methods. *Computational Management Science*, 11(4), 365-402.
23. Tavana, M., Abtahi, A. R., Di Caprio, D., & Poortarigh, M. (2018). An Artificial Neural Network and Bayesian Network model for liquidity risk assessment in banking. *Neurocomputing*, 275, 2525-2554.
24. Khrestina, M. P., Dorofeev, D. I., Kachurina, P. A., Usualiev, T. R., & Dobrotvorskiy, A. S. (2017). Development of algorithms for searching, analyzing and detecting fraudulent activities in the financial sphere.
25. Sudjianto, A., Nair, S., Zhang, A., Kern, D., Díaz, F. C., & Yuan, M. (2011). Statistical methods for fighting financial crimes. *Quality control and applied statistics*, 56(1), 141-142.
26. Villalobos, M. A., & Silva, E. (2017). A statistical and machine learning model to detect money laundering: an application. *Actuarial Sci. Dept. Anahuac Univ., Tech. Rep.*
27. Zareapoor, M., & Shamsolmoali, P. (2015). Application of credit card fraud detection: Based on bagging ensemble classifier. *Procedia computer science*, 48(2015), 679-685.
28. Aziz, S., & Dowling, M. (2019). Machine learning and AI for risk management. In *Disrupting finance* (pp. 33-50). Palgrave Pivot, Cham.



## Analysis Phase of Process Maturity Model for Rpa Implementation

Rasika Mallya

MCA Department, DES's Navinchandra Mehta Institute of Technology and Development, Dadar (W), Mumbai, India

### ABSTRACT

The organizations integrating Robotics Process Automation in their departments improve the efficiency in their business processes and personnel of these organizations focus on delivering more value to them based on their core expertise. Process Maturity Model for RPA assesses the processes which client desire to be automated. After assessment, Process Maturity Model results in best suitable candidate processes for automation. Subject Matter Experts, RPA Business Analysts and RPA developers are involved in this process. This paper focuses on analysis phase of Process Maturity Model. It also describes templates generated during this phase. In implementation section, the scenario of updating medical test reports into Electronic Health Record is considered. The Process Maturity Model implements analysis phase for this scenario and result is described in terms of feasibility matrix and ROI graphs.

Keywords: Robotics Process Automation, Process Maturity Model, Electronic Health Record

### I. INTRODUCTION

Every organization has a set of business processes, which consist of set of activities, events, decisions etc. The complexity of each business process is different. The efforts to analyze and optimize these processes also vary. Some of these business processes involve manual operations, repetitive and structured tasks that consume considerable efforts of employees. In modern context, the agent is introduced in business processes which is capable of handling these processes without human intervention. This technology is Robotics Process Automation which comprises "bots"- software agent to perform tasks which are typically rule-based, well-structured and repetitive. [1]

To implement RPA in existing software or automated environment, business analyst has to identify business processes which can be really automated. The Process Maturity Model can be used to decide strategy for identification of business processes suitable for automation. The Process Maturity Model is an evolutionary improvement path which provides roadmap for automation of suitable business processes. It consists of:

1. Automation pipeline
2. Feasibility Analysis
3. Complexity Assessment
4. ROI analysis
5. Automation Design
6. Deployment. [2]

Out of above steps of Process Maturity Model, first 4 phases are related to analysis phase and last two phases represent design phase for RPA application.

This paper focuses on analysis phase of Process Maturity Model for implementing RPA. For implementation purpose, a process of Electronic Health Record maintenance is considered. This research work is exploratory which applies PMM model to check whether converting medical test reports into Electronic Health Record is the suitable process for automation.

The structure of the paper is as follows: Section 2 elaborates RPA life cycle, Process Maturity Model and description of process of Electronic Health Record maintenance. Section 3 describes various templates describing phases of Process Maturity Model applied for automation of Electronic Health Record maintenance. Finally, the paper concludes with feasibility matrix and ROI analysis.

### II. LITERATURE REVIEW:

#### 2.1 Robotics Process Automation:

Robotics Process Automation is defined by IRPA-AI Institute as "the application of technology allowing employees in a company to configure computer software or a 'robot' to capture and interpret existing

applications for processing a transaction, manipulating data, triggering responses and communicating with other digital systems". [4][5]

This definition is based on the concept of automation of any workflow in the organization using 'bot', this workflow is structured and rule based and executed repeatedly by humans. This concept is used in Business Process Automation to improve competitiveness of organization, productivity and accuracy. [4] Following stakeholders are required to implement RPA in any organization:

1. **Subject Matter Expert (SME):** to identify right processes to automate with respect to business needs.
2. **Business Analyst:** To document processes, develop business rules and logic
3. **RPA Developer:** to develop bot for automation of process

Robotics Process Automation is the use of software with AI and ML capabilities to handle high- volume, repetitive tasks. Following tasks are performed through RPA implementation:

1. **Website Scrapping:** Web scrapping is the process of extracting meaningful and relevant data from websites with the help of bots. [6]
2. **Data Management:** In organizations, bots assist employees to fetch information from one legacy system, to make it available for new systems/
3. **Form Processing:** Bots can also assist in processing input forms to prepare database of system.

#### RPA Lifecycle

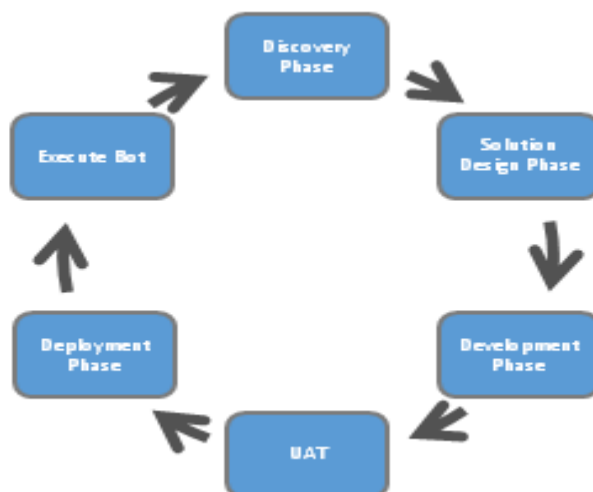


Figure 1: Robotics Process Automation Lifecycle

RPA Lifecycle includes different phases of the automation process. It initiates creation of bots and ends at execution of the bots.

#### Discovery Phase

This is the initial phase of RPA lifecycle. In this phase, the RPA process architect identifies and analyzes the requirements of the client. Based on analysis, it is checked whether the process can be automated. If the process is feasible for automation, then the RPA architect team can take the complexity of the process.

#### Solution Design Phase

Based on requirements, the steps are designed to automate the task. The RPA technical and process architect develop a **Process Definition Document (PDD)**, which includes logical steps for whole process.

After identification of requirements, the next step is to identify the resources such as budget, desired team size and timelines. Then, the analyst creates a flowchart to understand the logical flow of processes, which helps in choosing the right processes for automation. The development of bots and tasks automation are initiated using appropriate RPA tool.

#### Development Phase

In this phase, the RPA developer creates scripts/bots to automate the tasks with the help of RPA tools. Automation scripts/bots are generated based on PDD developed in solution design phase.

### UAT (User Acceptance Tests)

In this phase, the bots are tested by RPA development team. These bots are tested in a pre-production environment to examine how the users can use them to automate specific tasks. If the testing phase gets passed successfully, then it is further transferred to the next stage. Besides, if the testing fails, then it is transferred back to the development phase, where RPA developers examine errors found in the testing phase and solve them.

### Deployment and Maintenance Phase

Once the bots are bug free, the bots are deployed into the production environment. After the deployment process, users can use them to automate their tasks. The bots can be modified if requirements of automation are changed.

### Execute Bots

This phase includes the execution of the bots after deployment. Bots are checked to ensure that the implementation is performed as per requirements. [7]

The next section describes Process Maturity Model which is based on RPA lifecycle.

### 2.2 Process Maturity Model for RPA:

Process Maturity Model is evolutionary improvement path, which guides organization when they move towards automated business processes. Following are the stages of process maturity model:

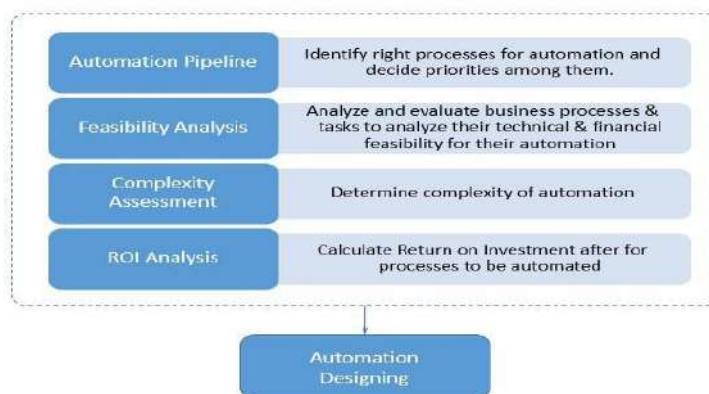


Figure 2: Analysis Phase of Process Maturity Model

Each stage of PMM is described in detail with output of each stage:

1. **Automation Pipeline:** In this stage, to identify right process and to prioritize processes, following activities are executed:
  - a. Candidate Identification: The processes eligible for automation are identified. This activity results into two sheets: Process Assessment and Process information as shown in figure 3.

Process assessment is done based on criterias like labour intensity and scale, volume and repetitiveness, input readiness, process definition, strategic relevance, likelihood of upgrade in short term and dependencies and constraints. Question related to each criteria is ranked from 1 to 10 in ascending order.

CRITERIA	DESCRIPTION	RANK (1 to 10)	
Labour Intensity and Scale	How many employees perform the process manually, and what is the scaling requirement?	1 Low Volume	10 High Volume
Volume & Repetitiveness	What is the volume of transactions within the process and what is the level of repetitiveness of tasks?	1 Not Repetitive	10 Highly Repetitive
Input Readiness	Are inputs (data source) for the process digitised in order to further be automated? If not, an additional step would be required before RPA	1 Paper Input	10 Fully Digitized
Process Definition	Is the Process well defined? Can all the logical scenarios be easily documented? If not, we have to build a robust exception handling mechanism	1 Not Defined	10 Well Defined
Risk & Customer Experience Alignment	What is level of risk associated with the process and is manual intervention a must to deliver superior customer experience?	1 High Risk	10 Low Risk
Strategic Relevance	What is the strategic importance of the process that may prevent it from being outsourced? What are the chances of the process being outsourced?	1 High Chance	10 Low Chance
Likelihood of upgrade in short term	Is the underlying / supporting system scheduled for an upgrade / replacement in the near future?	1 Highly likely	10 Unlikely
Dependencies & Constraints	What is the level of dependencies or constraints that would impede benefit realisation (e.g. constraints with harvesting staffing benefits)?	1 Not Good	10 Great

Criteria	Process 1	Process 2	Process 3	Process 4	Process 5	Process 6	Process 7	Process 8	Process 9
Labour Intensity & Repetitiveness	10								
Input Readiness	7								
Process Definition	7								
Risk & Customer Experience Alignment	5								

Figure 3: Process Assessment Template

Process information sheet contains information of processes which is used to determine complexity of process. This sheet contains information of process based on three parameters: a. Process Metrics b. Input readiness c. technology landscape as shown in figure 4.

Metric		Process 1	Process 2
Process Metrics	Process Name		
	Process Owner/ Department		
	Process Description - Details about what the process does		
	Process Map/ Workflow documented (Y/N)		
	Number of resources currently working on this process		
	Hours per month per resource		
	Total # of transaction processed per month		
Input Readiness	Does the process have the need for manual intervention like making a decision or calling/ emailing the customer for more information or researching for more information? (Y/N)		
	If the above answer is (Y) what % of record\ transactions require manual intervention		
	Data Input Source (Excel/ CSV/ Database etc)		
Technology Landscape	RDBMS database involved - Name		
	Does the process involve reading data from PDF or TIF files (Y/N)		
	If the above answer is (Y) then is the Data structured (PO\Invoice\Claims etc) or unstructured (Contracts\Agreements\Deeds\Catalogs etc)		
	Core Application 1 (Name of Primary Application, Avg. number of screens)		
	Core Application 2 (Name of Other Application, Avg. number of screens)		
Core Application 3 (Name of Other Application, Avg. number of screens)			
Does the process run over Citrix (Y/N)			
Does the process require RDP (Y/N)			

Figure 4: Process information matrix

- b. Top level benefit analysis: This activity lists and weighs organizational priorities based on focus areas in descending order of their priority to business, type of priority and percentage to its priority. The total priority percentage shall be 100%. This percentage is used in candidate prioritization process.

Top Level Benefit Analysis: Define weight of business priorities			
Priority	Focus Areas	Type	Priority Percentage
1	Save manual hours and repurpose employee time	Dollar	50
2	Improve quality through error reduction	Attribute	20
3	Streamline mission critical processes	Attribute	5
4	Improve employee experience/ moral	Attribute	5
5	Improve customer satisfaction	Attribute	10
6	Adhere to regulatory compliance	Attribute	10
			<b>100</b>

Figure 5: Top level benefit analysis

Once all processes are analysed, results are collated and candidate prioritization is done.

- c. **Prioritization:** This is achieved using brainstorming and sorting. In brainstorming sheet, the basic information of shortlisted processes is populated. This also includes rough estimate of percentage of process which can be automated.

Category	Metric	Process 1	Process 2	Process 3	Process 4	Process 5
Basic Info	Process Name	Project Control - Purchase Requisition Approval (Americas)	Project Control - Vendor Tooling (Internal Contracts) NA	Capitalization - Reporting (Tags) NA	Generating Asset IDs (Americas)	
	Process Description					
User Input Required	% of Task that can be Automated	90%	100%	70%	100%	
	Number of Personnel	7	6	5	9	
	Hours (per person)	4	4	5	3	
	Times Per Year	240	240	120	240	
	Average Pay/Hour	\$16	\$16	\$16	\$16	
Readiness	Error Reduction	5	5	5	5	
	Mission Critical	5	5	5	5	
	Employee Morale	2	1	1	1	
	Customer Satisfaction	5	5	5	5	
Trends	Regulatory Compliance	1	1	1	1	
	Complexity to Automate	Medium	High	Low	High	
80%	Business Priorities Percentage	85%	80%	80%	80%	0%
80%	Manual Dollars Saved Annually	\$97,578	\$92,160	\$11,600	\$101,680	50
80%	Hours Saved Annually	9048	1766	2100	8488	0

Figure 6: Brainstorming sheet

The data is entered in manual hours metrics. In third metrics, each process is assigned with relevant business priority scaling from 0 to 5. Based on three metrics, complexity of processes is defined as high, medium and low.

In sorting sheet, data is already entered on the basis of brainstorming sheet. In this step, the processes will be sorted according to Business Priority score or Manual Dollars saved score or complexity to automate. Graphical representation of processes will be generated based on selection criteria.

Figure 7: Sorting Sheet

2. **Feasibility Analysis:** Feasibility analysis is performed once processes for automation are identified and prioritized. This technique analyses and evaluates business processes and tasks to analyse technical and financial feasibility for their automation. Feasibility analysis is performed with following steps:
  - a. **Gather resources:** Resources are: i. subject matter experts who have designed the processes. ii. Employees: who will be using processes and iii. Hardware and software: required to execute processes.
  - b. **Examine:** After gathering resources, it is important to understand how the processes are executed manually in organization. This information is necessary to understand the scope for increasing productivity and efficiency of task.
  - c. **Understanding the logic:** The business analysts understands the logic and rules used for completing the task.
  - d. **Checking elements that prevent automation:** If the processes involve making decisions based on employees' experience or processes depending on fuzzy logic, handwritten documents, captcha codes cannot be automated.
  - e. **Checking elements that require further testing:** ActiveX applications, Java, flash, cycle-time constraints need extra testing. Thus, such applications are identified separately.

The results of feasibility analysis is represented in feasibility matrix. This is divided into two parts: feasibility matrix and legends. Feasibility matrix consists of three parts: i. Process Input: questions related to different parameters of processes ii. Technical feasibility: questions related to technical aspects on processes iii. Volumetric Section: questions related to volume of work in processes involved.

The output of feasibility matrix is feasibility index value and feasibility rating.

Figure 8: Feasibility Assessment Template: Process Input part

Technical Feasibility	2.1	Does Process involve working in Citrix?	Yes
	2.1.1	If 'Yes' : Can you do Ctrl+C of the data field you want to read and do Ctrl+V on the application you want to move the data?	No
	2.1.1.1	If 'No': Can the data be extracted from any other system?	No
	2.4	Does the process include judgemental decision making, considering multiple criteria? (e.g. Credit Assessment)	No
	2.5	What Percentage of Volume has dependency on clarification from customer through calls/emails?	81-100%
Volumetric	3.1	How many FTEs are involved in process?	
	3.2	What is avg. daily volume flowing through the process?	
	3.3	What is Average Handling Time?	
Notes	Comments:		

Figure 9: Feasibility Assessment Template: technical feasibility and volumetric

The below screenshot of legends describes how feasibility rating depends on feasibility index value or score.

Feasibility Index			
Sr. No.	Rating	Score	Automation Comments
1	High	29-35	Good candidate for Automation
2	Medium	15-28	Automation is possible but with some challenges
3	Low	0-14	It is not a good candidate for Automation

Figure 10: Feasibility Legends

### 3. Complexity Assessment

This step is executed after feasibility analysis. This process determines complexity of automation and estimates efforts for development and efforts for standardization. This is performed using complexity calculator. This calculator is divided into 2 sections: a. User input required b. results

Complexity calculator calculates complexity with following steps:

- Enter process names prioritized for automation
- Study input metrics for each process
- Determine data for input metrics gathered from SME sessions
- Define the input metrics on the calculator based on determined data.

Each process is studied with input metrics such as manual hours, personnel quantity, no of departments, technology landscape, information silos, process steps, data size, business logic etc.

	Metric	Process 1	Process 2	Process 3	Process 4	Process 5
User Input Required	Process Name					
	Manual Hours (Hours Monthly)					
	Personnel Quantity (People)					
	Departments					
	Technology Landscape					
	Information Silos					
	Process Steps					
	Data Size (Records/Rows)					
	Business Logic (Complexity)					
	Deployment (Complexity)					
Results	Standardize (Complexity)					
	Estimated Development Effort - Low					
	Estimated Development Effort - Medium					
	Estimated Development Effort - High					
	Estimated Standardization Effort - Range					

Figure 11: Complexity Calculator

### 4. ROI Analysis

ROI analysis is the measure of the returns derived from automation compared to the time and costs in implementing automation. It calculates estimate of overall profit earned due to automation. To calculate ROI

analysis, all inputs related to savings and cost are required. Different categories of possible savings are considered in ROI analysis: manual hours saved, quality improvement, productivity gain, improved business agility, increased customer satisfaction and brand awareness and improved regulatory compliance. Different cost factors are identified as: cost of software and cost training employees.

Thus, Return on Investment is the measure of total points after deducting total cost from total savings in a given period, ROI analysis is performed using ROI calculator. ROI calculator generates two sheets: ROI details and ROI Summary. ROI summary sheet presents a comprehensive textual and graphical report of business value parameters such as the ROI and profit percentages involved in automation.

Enter data in blue fields - Annual figures			Cost of Solution		
Item			Qty.	Unit Price	Price
<b>Save manual hours</b>					
		\$1,248,000			
1	Number of processes	30	Automation Anywhere Enterprise Platform	0	\$0
	On average each process saves X hours in a day	5	Additional AAE Control Rooms	0	\$0
	Number of times the process runs in a week	4	Additional AAE Development Clients [Bot Creators]	0	\$0
	Total hours saved in a year	31200	Additional AAE Runtime Clients [Bot Runners]	0	\$0
	Cost per hour	\$40			\$0
	Savings (With only Manual Hours Saved)	\$1,248,000	Getting Started - Training/Services - 6		\$0
<b>Improved Quality through Error Reduction</b>					
		\$23,400			

Figure 12: Template for ROI details

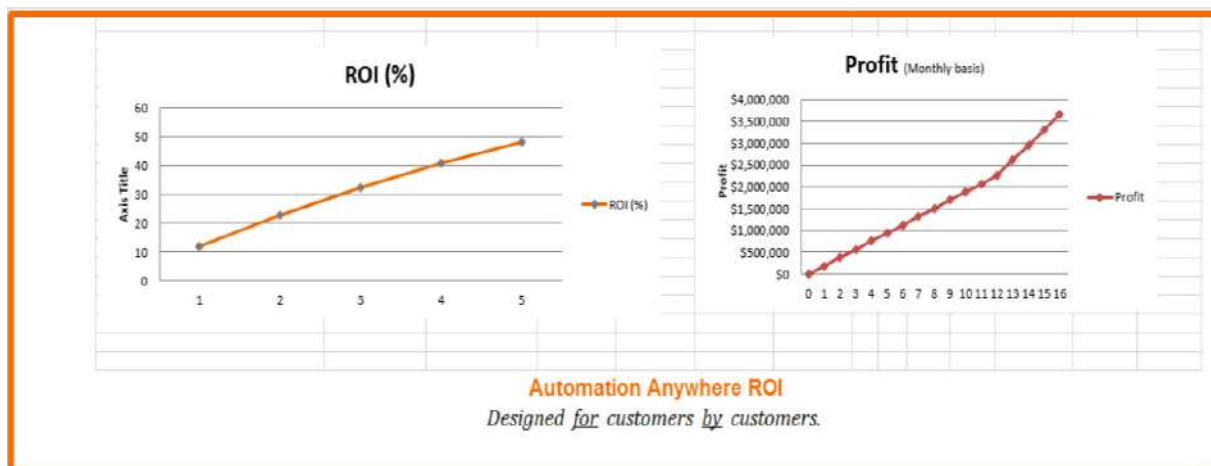


Figure 13: Template for ROI Summary – Graphical Representation

This completes analysis phase of Process Maturity Model for automation. The next section elaborates the case study on which PMM will be applied. [8]

### 2.3 Electronic Health Record Automation:

Electronic Health Record was introduced in healthcare field to aid physicians and healthcare workers to deliver quality healthcare and maintain contents of EHR secured. EHR system maintains information regarding patient care such as demographics, progress notes, problems, medications, vital signs, medical history, immunization, lab data, imaging reports etc. This information of particular patient will be available to any doctor irrelevant of location and time for fast accurate treatment to patient anywhere in the world. [9]

Health Information System (HIS) captures, manages and transmits patient related information which becomes Electronic Health Record. This can be integrated with Health Smart Card to provide non-volatile patient-related data electronically as prior hospitalization, diagnosis, critical treatment and allergies.[9][10]

When patient undergoes any medical tests or clinical treatment, the reports shall be updated in Electronic Health Record of that patient. The assistant of doctor may waste ample time to add reports into Electronic Health Record of patient. Thus, it was a need of medical industry to automate this process. The next section analyzes the possibility to design bot which will convert medical reports into Electronic Health Record without human intervention. [10]

### III. Analysis of automation for updating Electronic Health Records using PMM:

The workflow of EHR updation is as shown in figure:

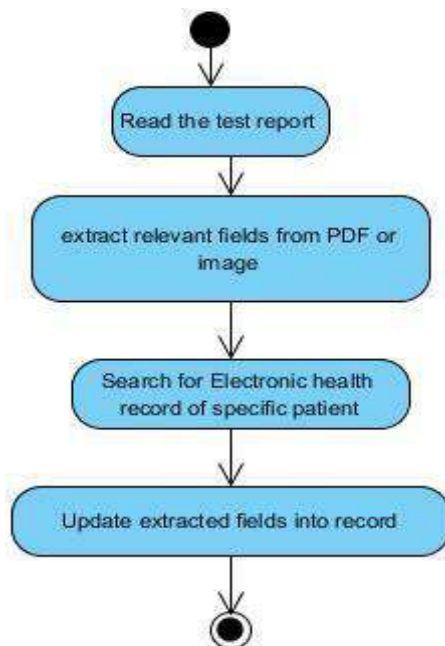


Figure 14: Workflow for Updating Medical Test Reports in Electronic Health Record

The analysis phase of PMM begins, automation pipeline process is applied for identified process and process assessment sheet will be generated as follows:

Process Assessment Sheet	
	<b>PROCESS:</b> Updation of test reports into EHR
<b>CRITERIA</b>	
Labour Intensity and scale	10
Volume and repetitiveness	10
Input Readiness	10
Process Definition	10
Risk and customer experience	5
Strategic Relevance	4
Likelihood of upgrade in short term	6
Dependencies and constraints	2

Figure 15: Process Assessment Sheet for Case study

Process Information matrix to determine complexity of process is as shown below:

Process Information Sheet		
	<b>Process: Updation of test reports into "EHR"</b>	
<b>Process Metrics</b>	Metric	Process Name: Updation of test reports into "EHR"
	Process Owner	Hospital
	Process Description	attached
	Process map/ workflow document	attached
	Number of resources currently working on this process	2 per department
	Hours per month per resource	approx. 180 hours
	Does process involve manual intervention	No
<b>Input Readiness</b>	If yes, how much %	
	Data Input source (Excel/ CSS/ Database)	PDF
	RDBMS database involved- Name	EHRDB
	Does the process involve reading data from PDF or image	Yes
<b>Technology Landscapes</b>	If yes, data is structured or unstructured?	Structured, structure can vary
	Core Application 1 ( name of primary application, Avg. number of screens)	Health Information system Avg. no of screens: 5
	Core Application 2 ( name of primary application, Avg. number of screens)	Maintenance of "EHR", Avg. no of screens: 3
	Core Application 3 ( name of primary application, Avg. number of screens)	NA
	Does the process run over any specific technology?	Yes

Figure 16: Process Information Sheet for Case study



Output of top level benefit analysis for above mentioned process:

Top Level Benefit Analysis: Define weight of business priorities			
Priority	Focus Areas	Type	Priority Percentage
1	Save manual hours and repurpose employee time	Dollar	55
2	Improve quality through error reduction	Attribute	30
3	Streamline mission critical processes	Attribute	1
4	Improve employee experience/ moral	Attribute	2
5	Improve customer satisfaction	Attribute	2
6	Adhere to regulatory compliance	Attribute	10
			<b>100</b>

Figure 17: Top Level Benefit Analysis for Case study

**Prioritization:** Brainstorming and sorting sheets are also prepared for above mentioned process and following are the results of prioritization:

Brainstorming Sheet		
	Metric	Process 1
	Process Name	Updation of test reports into "EHR"
	Process Description	
<b>Manual Hours</b>	% of task that can be automated	100
	Number of personnel	5
	Hours (per person)	6
	Times per year	1614 hrs
	Average pay	
<b>Business Priorities</b>	Error Reduction	5
	Mission Critical	4
	Employee Morale	5
	Customer Satisfaction	4
	Regulatory Compliance	5
	<b>Complexity to Automate</b>	<b>Medium</b>
	<b>Business Priorities percentage</b>	<b>85%</b>
	<b>Manual dollars saved annually</b>	
	<b>Hours saved annually</b>	<b>1614</b>

Figure 18: Brainstorming sheet for Case study

Average pay and manual dollars entries are avoided considering context of paper.

### Feasibility Analysis:

Following sheet represents feasibility index and result of feasibility analysis.

Feasibility Matrix			
Business Unit	Pathology Lab		
Business Unit Vertical			
Process Name	Updation of test reports into "EHR"		
Project Manager			
Note: Please respond to following questions in the context as you identified the process.			
	Sr. No.	Questions	Operations
Process Input	1.1	What percentage of your input is in scanned format?	100%
	1.2	Do you have access to scanned data in electronic format?	Yes
	1.3	What percentage of your input in electronic format allows ctrl C and ctrl V?	100
	1.4	In case of structured data, do we have standard format/ layout?	yes
Technical Feasibility	2.1	Does process involve working in Citrix?	No
	2.1.1	if 'yes', Can you do ctrl+c to read data and ctrl V on other application to write data?	
	2.1.2	If 'no', Can data be extracted from any other system?	yes
	2.2	Does the process involve judgemental decision making?	no
	2.3	How much percentage processes have dependency on clarification from customer calls?	0%
Volumetric	3.1	What is the average daily volume flowing through process?	50%
	3.2	What is the average handling time?	15 minutes for each report
<b>Score</b>			<b>32</b>
<b>Feasibility Index</b>			<b>High</b>
<b>Conclusion: Good candidate for automation</b>			

Figure 19: Feasibility Matrix for Case study

With these assumptions, Complexity assessment and ROI analysis are also performed resulting medium efforts of development and substantially beneficial ROI.

### IV. CONCLUSION

As section III describes Process Maturity Model is applied for analysis of automation process for Electronic Health Record updation with respect to medical test reports. The outcome of analysis phase of Process Maturity Model is process assessment sheet, process matrix, top level benefit analysis, brainstorming sheet, feasibility matrix, complexity assessment and graphical representation of ROI analysis. Out of which process assessment sheet, process matrix, top level benefit analysis, brainstorming sheet, feasibility matrix are represented in above section based on workflow. The analysis concludes that automation process for Electronic Health Record updation with respect to medical test reports is a good candidate for automation due to high feasibility index, rising ROI. Further study will incorporate automation design of software bots and deployment steps.

If the mentioned process will be completely automated with autonomous bots, then 40% of daily manual work for pathology lab workers will be saved and they can use their time to focus on quality improvement in process of medical tests execution and research. The advantage of this automated process is Electronic Health Record of patients will remain updated forever with latest tests. Thus, patients don't have to remember when he/she has

undergone the tests in recent times. Limitations in above automation is if any new test is introduced in pathology with different test report template then bots will need customization.

#### V. REFERENCES

1. LUCAS CARRARO, “Analysis of business process models and RPA”.
2. Charles Sutherland, EVP of Research, HfS Research, “The Evolving Maturity of Robotic Process Automation”, Architects of Global Business, 2014, HfS Research, Ltd [www.hfsresearch.com](http://www.hfsresearch.com) | [www.horsesforsources.com](http://www.horsesforsources.com) | [bpo.horsesforsources.com](http://bpo.horsesforsources.com)
3. <https://www.ibm.com/cloud/blog/amazing-ways-that-rpa-can-be-used-in-healthcare>
4. J. G. ENRÍQUEZ, A. JIMÉNEZ-RAMÍREZ, F. J. DOMÍNGUEZ-MAYO, AND J. A. GARCÍA-GARCÍA, “Robotic Process Automation: A Scientific and Industrial Systematic Mapping Study”, Article in IEEE Access · February 2020 DOI: 10.1109/ACCESS.2020.2974934
5. IRPAAI Institute. (2019). The Automation of Knowledge Work will be This Decade’s Engine of Growth. Accessed: Sep. 2019. [Online]. Available: <https://irpaai.com/definition-and-benefits/>
6. <https://research.aimultiple.com/rpa-web-scraping/>
7. <https://medium.com/emorphis-technologies/robotic-process-automation-stages-of-rpa-life-cycle-e0f8180a11d6>
8. Automation Anywhere Business Analyst (v11): <https://automationanywhere.litmos.com/home/LearningPath/117276?r=False&ts=637816906283020187>
9. Bakheet Aldosari, “Patients' safety in the era of EMR/EHR automation”, <https://doi.org/10.1016/j.imu.2017.10.001> Accepted 4 October 2017 Available online 5 October 2017, Informatics in Medicine Unlocked 9 (2017) 230–233
10. Augustine Gatimu Njuguna, Electronic Health Record System: Automation of Health Records, 2017

## Review on the Use of Expert System in Cognitive Development of Children

Gauri Deshpande<sup>1</sup> Shabnam Sharma<sup>2</sup> and Anjali Kulkarni<sup>3</sup>

<sup>1</sup>Computer Science, Shri JYT University, Rajasthan, India

<sup>2</sup>Computer Science, CMR University, Bangalore, India

<sup>3</sup>Computer Science, C. K. Thakur ACS College, New Panvel, India

### ABSTRACT

The future of a country depends on child development, which includes various forms like biological, cognitive, language, social, emotional, speech, fine motor, and gross motor. These forms are essential for children's growth and development. Cognitive development is crucial for improving cognitive abilities such as thinking, listening, learning, understanding, and justifying questions. Nowadays, an expert system plays vital role in handling the psychological factors of human beings. Currently, available expert systems in the cognitive development domain are examined along with an assessment of their features and limitations. The expert system is capable of extracting current and future knowledge, estimating future outcomes, improving decision-making quality, and offering quick and robust solutions to complicated problems. This study has shown examples of expert systems with their computational decision-making systems also examine existing expert systems that are used to develop children's skills. The consequences of these systems on cognitive development should be examined in more inclusive studies.

Keywords: Cognitive development, Expert System, Decision-making, Skills, Knowledge.

### 1. INTRODUCTION

Children are the future assets of the nation. The progress of the nation depends on its grooming. Cognitive development is crucial for grooming children. Many Artificial Intelligence and data mining techniques are used to estimate the cognitive development of children.

#### Cognitive Development

Human beings collect, arrange, and use their knowledge through the process of cognitive development. The progress of cognitive conduct is the improvement of statistics, capacities, trouble-solving, and personality that provide help to kids to deliberate and understand the sector.



Figure 1: Cognitive Skills

Jean Piaget has explored four stages of cognitive development.

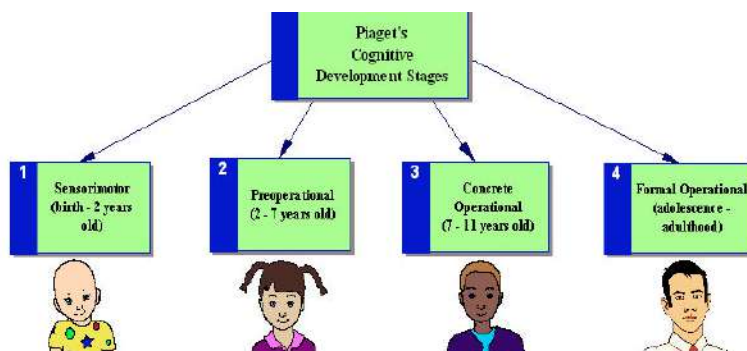


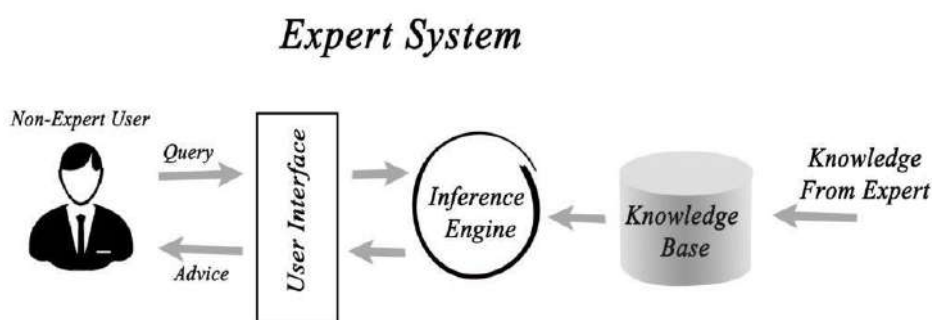
Figure 2: Piaget's Cognitive Development Stages

Within the sensorimotor stage (up to 2 years) children can adopt the surroundings with their senses and in the preoperational level (2 years to 7 years) children can broaden their creativeness and reminiscence. Within the concrete operational level (7 years to 11 years) youngsters grow to be extra conscious of feelings, and in the formal operational phase (11 years and older) they use common sense to highlight problems or see areas. Many factors affected the cognitive improvement of kids like organic, environmental, gender, enjoyment, and circle of relatives. Children's mental degree can be assessed by assigning a stage to each mental factor. Nowadays, the psychological elements of human beings are dealt with greater efficiently by means of expert systems. It simulates the conduct of human specialists and assesses the psychological factors of the kid consisting of intelligence, reminiscence, concentration degree, and so on. The cognitive development area has benefited from massive methods together with records, class, and prediction for studying numerous dimensions of cognitive development.

### EXPERT SYSTEM:

Expert systems are a popular branch of artificial intelligence that has numerous applications across multiple domains. Expert systems are interactive computer programs that contain the experience, knowledge, and skills of an expert or group of experts to solve the problem [10]. Expert systems fall into five basic categories: rule-based, frame-based, fuzzy, neural, and neuro-fuzzy.

Following are the components of the Expert System:



**Figure 3:** Components of expert system

1. **Knowledge base:** The knowledge base in the expert system represents facts and rules. The knowledge base obtained from the human expert is prepared by a knowledge engineer [23].
2. **Inference engine:** An inference engine is used to extract significant information from the knowledge base, translate it, and discover solutions to the user's problem.
3. **User interface:** This component is important for making the interaction between user and expert system and finding the right solutions.

This study explores expert system applications in the cognitive development of children, such as detection of intelligence, addiction, and prediction of disease. It also provides suggestions or guidelines based on obtained results.

## 2. LITERATURE REVIEW

Various psychological development research had been implemented the usage of distinct statistical and computational techniques which includes Statistical package for the Social Sciences, Crypt-arithmetic, Fuzzy methods, and classification and prediction algorithms.

A cognitive model plays a critical role in psychological development. This may be evolved the usage of special techniques. A Java-based expert system became shaped to determine a kid's intelligence and expect their career possibilities [4]. Crypt arithmetic techniques have been used to find mental components such as intelligence, problem-solving, and endurance [27]. The certainty factor approach is regularly balanced with minimal cost in expert systems. This technique was used to calculate a child's intelligence [29] and also used to expect an early prognosis of personality disorder based on its signs [5]. The SL5 object language specifies the use of professional structure regulation-based logic. Such expert systems have been used to diagnose depression levels and provide counseling based on them. [9] The system was also used to detect nausea and vomiting in children [23]. A similar study [24] used this expert system to detect health problems related to video game addiction. Statistical Package for the Social Sciences (SPSS) is basically used for analysis. Using this method, anxiety and depression were analysed with an accuracy of 75% and 55%, respectively [26]. Weighted product is a multi-

criteria decision making technique. This method was used to determine the best way to diagnose a baby's illness, which revealed a number of illnesses in infants [18]. The fuzzy expert system is an artificial intelligence system that uses a collection of membership functions and rules. This system was used to detect the affective and cognitive status of Maths subjects from individual learners [7]. A similar study [17] obtained types of child intelligence using the fuzzy method. Various data mining and AI techniques such as classification, regression, clustering, and prediction were used to evaluate psychological progress. In study [3] various algorithm of data mining were used to classify and predict children's progress [3]. Fuzzy clustering is used for cluster analysis and this approach was used to expect learning disabilities in children [15]. Forward chaining and uncertainty factor methods were used to stumble on signs of game addiction along with excessive, common, and low [20] and were extensively utilized to decide the traits of youngsters with special desires [22]. The decision tree, forward and backward chaining technique became used to diagnose memory loss diseases like Alzheimer's, Parkinson's, Huntington's, and dementia, and suggested treatments for them [14]. A similar study [21] was used to predict children's mental retardation. Naive Bayes, Neural community, J48, SMO, and RBF algorithms were used to achieve attention deficit and hyperactivity disorder in adolescence [8]. A neural network was used to develop a model to assist teachers in detecting mathematically gifted pupils in elementary schools. [16]. ANN and regression techniques were used to generate remedy plans for human beings with speech-language issues, handling clinical data, and cognitive improvement statistics [28]. Principal Component Analysis and correlation-based algorithms have been used to anticipate disability learning [11]. Agent and heuristic-based algorithms were used to diagnose and compare the gaining knowledge of disabilities of unique needs students [12]. Bayes theorem turned into used for predicting the net dependency degree of youngsters [19]. A study [25] was used to predict human behavior on social media using CLIPS. Autism Diagnosis and Advisory Expert System was developed to offer parents an initial diagnosis of Autism Spectrum Disorder (ASD)[2]. Visual basic .Net language was used to diagnose ear problems in children and provides advice based on obtained results [13]. Web based expert systems were applied to diagnose baby improvement and examine preschool kids' language [1][6]. In a study [10] learning disabilities were determined by considering psychomotor aspects like intellectual, perceptual, language, and personal.

### **3. APPLICATION AREA**

This research is focuses on cognitive development. It is essential for parents to develop cognitive skills to identify causes and effects, as well as to develop analytical skills. Specialist systems can be used to assess a child's mental abilities and these assessments can be used to diagnose child psychological problems and provide recommendations for dealing with the child. This study can also have a positive impact on society by creating expert system models that are used to mimic human psychological processes and provide useful information to a person. In addition, this study may lead to the development of a professional program that is used to manage child addiction or other related disorders.

### **4. CONCLUSION**

The expert system is a computational technology that solves complex problems using task-specific information and inference, similar to the skills of human specialists. The performance of traditional methods has been significantly surpassed by expert systems. This study examines the applications of expert systems in child mental development over the past two decades, highlighting the importance of expert systems in child cognitive development. According to the reviewed research, psychological factors can be assessed using expert systems and various methods. Furthermore, in order to overcome the limitations of different approaches, an integrated expert system must be built based on different approaches. For an accurate result, more research or progress is needed. Expert systems form rule-based systems to improve children's cognitive abilities. This can be achieved by identifying those problems and finding solutions using expert systems. This system is beneficial for parents to manage the mental disorders of the child.

### **5. FUTURE SCOPE**

Cognitive skills are important for a child's development because they affect learning and performance. Weak cognitive skills are an unusual reason for knowing difficulties. Various strategies to improve children's skills or solve their problems have been validated in the past. However, development requires improvement in decision-making ability, interest, processing speed, visual processing, auditory processing, recall, and many other skills. Future work can take advantage of computational strategies to implement all capabilities simultaneously. Various factors related to child development including cognitive, linguistic, social, emotional, speech, fine motor, and gross motor can be enhanced with the help of special structures. In the future, the Expert System may support a variety of packages that allow for new insights and progress of change.

---

---

**REFERENCES**

1. A P Gusman, H Hendri(2019). "Expert system to diagnose child development growth disorders with forward chaining method". International Conference Computer Science and Engineering, doi:10.1088/1742-6596/1339/1/012045, 1-8.
2. Amal Al- Wahaibi et.al. (2016). "The Development and Acceptance of Autism Advisory Expert System". International Journal of Computing & Information Sciences,doi:http://dx.doi.org/10.21700/ijcis.2016..121, Vol- 12, No. 2,179-187.
3. Ambili K, & Afsar P (2016). "A Prediction Model for Child Development Analysis using Naive Bayes and Decision Tree Fusion Technique – NB Tree". International Research Journal of Engineering and Technology (IRJET), p-ISSN: 2395-0072, Vol-7, Issue-7,402-407.
4. Ch.Ravalika et.al.(2017). "An expert system for assessing intelligence quotient of a student in building a cognitive model". International Journal of Pure and Applied Mathematics, ISSN: 1311-8080, Vol-115 No. 8,487-492.
5. Christine Putri Batara Randa(2014). "Development of Diagnosis Expert System for Personality Disorders. International Conference on Electrical Engineering and Informatics", ISBN- 978-1—4799-6274-7, 317-320.
6. Eugenia I. Toki (2012). "An Online Expert System for Diagnostic Assessment Procedures on Young C Oral Speech and Language". Proceeding of the 4th International Conference on Software Development for Enhancing Accessibility and Fighting-exclusion, doi: http://dx.doi.org/10.1016/j.procs.2012.10.049, 428-237.
7. Gwo-Jen Hwang et. al.(2020). "A fuzzy expert system-based adaptive learning approach to improving students' learning performances by considering affective and cognitive factors". Computers and Educations: Artificial Intelligence, doi: 10.1016/j.caeai.2020.100003, 1-25.
8. Hanife Goker , Hakan Tekedere(2019). "Dynamic Expert System Design for the Prediction of Attention Deficit and Hyperactivity Disorder in Childhood", Bilişim Teknolojileri Dergisi, Cilt: 12, SAYI: 1,doi: 10.17671/gazibtd.458102 ,33-41.
9. Izzeddin A. Alshawwa et. al.(2019). "An Expert System for Depression Diagnosis". International Journal of Academic Health and Medical Research (IAHMR), ISSN: 2000-007X, Vol- 3, Issue-4, 20-27.
10. Jose Hernández et.al.(2009). "Learning Difficulties Diagnosis for Children's Basic Education using Expert Systems". WSEAS TRANSACTIONS on INFORMATION SCIENCE and APPLICATIONS, ISSN-1790-0832, Vol-6, Issue-7, 1206-1214.
11. Julie M. David, Kannan Balakrishnan(2013). "Performance Improvement of Fuzzy and Neuro Fuzzy Systems: Prediction of Learning Disabilities in School-age Children". International Journal of Intelligent Systems & Applications, doi: 10.5815/ijisa.2013.12.03, Vol-5, Issue-12, 34-52.
12. Khaled Nasser elSayed(2013). "Diagnosing Learning Disabilities in a Special Education by an Intelligent Agent Based System". (IJACSA) International Journal of Advanced Computer Science and Applications, Vol-4, No. 3,125-130.
13. Khdega A.Yosef Galala(2015). "An Expert System for Diagnosis of Ear Problems in Children". International Journal of Advanced Research in Computer and Communication Engineering, p-ISSN 2319 5940, Vol-4, Issue-7,458-462.
14. Margaret Mary et. al.2019). "Intelligent Predicting Learning Disabilities in School Going Children Using Fuzzy Logic K Mean Clustering in Machine Learning". International Journal of Recent Technology and Engineering (IJRTE), ISSN: 2277-3878, Vol-8, Issue-4,1694-1698.
15. Margita Pavlekovic et.al.(2009). "Comparison of intelligent systems in detecting a child's mathematical gift". Computers & Education , doi:10.1016/j.compedu.2009.01.007,Vol-53, Issue-1,142-154.
16. Miss. Komal R. Hole, Prof. Vijay S.Gulhane(2014). "Rule-Based Expert System for the Diagnosis of Memory Loss Diseases". International Journal of Innovative Science, Engineering & Technology, ISSN 2348 – 7968, Vol-1, Issue-3, 80-83.

17. Muhamad Bahrul Ulum and Vitri Tundjungsar (2018). "Designing Fuzzy Expert System to Identify Child Intelligence". TELKOMNIKA, doi: <http://dx.doi.org/10.12928/telkomnika.v16i4.7779>, Vol-16, No.4, 1688-1696.
18. Muhamad Muslihudin et.al. (2019). "Expert System in Determining Baby Disease using web mobile based weighted product method". International Journal of Recent Technology and Engineering, ISSN: 2277-3878, Vol-8 , Issue-1,3299-3308.
19. Muhammad Fikrul Ilmi(2018). "Expert System to Diagnose Internet Addiction Levels using Bayes Theorem Method", doi: <https://doi.org/10.21107/ijseit.v3i1.4509>, Vol- . 3, Issue-1.
20. Muhammad Mujib Al Khafid et.al.(2021). "Expert System Detecting Symptoms of Game Addiction with The Forward Chaining Method And Certainty Factor". 2<sup>nd</sup> International Conference of Health Science and Technology, ISBN-978-623-92207-1-6, 214-218
21. Riyan Naufal Hays(2020). "Expert System for Predicting Children Mental Retardation using Forward Chaining". 1<sup>st</sup> International conference on Islam, Science and Technology, DOI:10.4108/eai.11-7-2019.2298027.
22. Robby Rizky ,Zaenal Hakim(2020). "Expert System to Determine Characteristics of Students with Special Needs with Forward Chaining Method". Advances in Health Sciences Research, doi:10.2991/ahsr.k.200723, Vol-27,236-240.
23. Samy S Abu Naser (2016). "An expert system for nausea and vomiting problems in infants and children". International Journal of Medicine Research, ISSN: 2455-7404, Vol- 1, Issue-2,114-117.
24. Samy S. Abu Naser, Mohran H. Al-Bayed (2015). Detecting Health Problems Related to Addiction of Video Game Playing Using an Expert System. World Wide Journal of Multidisciplinary Research and Development, e-ISSN: 2454-6615, 7-12.
25. Shobhana Kashyap (2017). "Predicting Human Behaviour on Social Media Using Expert system tool CLIPS". International Journal of Engineering Development and Research, ISSN: 2321-9939, Vol-5, Issue-2, 1522-1528.
26. Syeda Huma Jabeen et.al. (2018). "Cognitive Behavioural Therapy to Compute Psychological Illness of Students by Using an Expert System". Journal of Depression and Anxiety, ISSN-2167-1044, Vol-7, Issue-4, 1-6.
27. V. Chandra Prakash et.al. (2019). "Expert system for building Cognitive model of a student using Crypt Arithmetic game and for Career Assessment". International Journal of Recent Technology and Engineering, ISSN-2277-3878, Vol-7, Issue-6S, 410-416.
28. Vladimir E. Robles-Bykbaev et. al.(2015). "An expert system to generate therapy plans for speech and language disorders. Expert Systems with Applications", ISSN-0957-4174, Vol-42, 7641-7651.
29. Yulian Purnama et.al.(2020). "Expert System in Detecting Children's Intelligence using Certainty Factor". Journal of Critical Reviews, ISSN-2394-5125, Vol-7, Issue-1, 52-55.



## Impact of Artificial Intelligence across Different Workforce Sectors

Maria Achary<sup>1</sup> and Ramakrishnan Achary<sup>2</sup>

<sup>1</sup>Department of PGDM, Smt. Jayshree Sharadchandra Kothari Business School, India

<sup>2</sup>AI Solutions Architect, India

### ABSTRACT

Current Trends of Market, based on pre and post covid-19 situation we can see a huge difference in working methodology, Co-operate sector, Business sector, Education sector, Healthcare sector, etc..., which has adopted a completely different ecosystem to enhance them with the usage of Robotics, AI, Blockchain, etc...Especially Information Technology has groomed in such a manner which can be easily be integrated using Artificial Intelligence in Financial, Human Resources, and Marketing Sector. This paper deals with different aspects of Management by utilizing the core competence of utilizing different techniques of Artificial Intelligence and how it has overcome the issues by providing the best support systems. We have analyzed the same and the response of adaption to the AI Support Systems is 87.56%. Because of the different neural network topology complex problems, solutions can be easily resolved using them.

Keywords: Artificial Intelligence, Managers, Business Sector, Management level.

### 1. INTRODUCTION

Current Trends of Management based on post-pandemic situations have adapted different technology and special focus of Artificial Intelligence, Robotics, etc...The major issues are faced by managers to understand the technical perspective of Artificial Intelligence techniques based on specific domains. Artificial Intelligence is a way in which we make the system think intelligently. A maximum of businesses realize that AI can benefit them in their operations, and utilize them to perform more effectively (Buck & Morrow, 2018; Euchner, 2019; Marvin & Horowitz, 2018). Artificial intelligence is a wide area of Computer Science that is concerned with building smart machines which are capable of performing tasks that typically require human intelligence. It's estimated that by 2025 the amount of work done by machines from 29% will be increased to 50%[3]. Most people's perspective of AI is reducing jobs, but it is not the same as AI is making job profiles much more effective and best.

#### 1.1 AI in HR Sector

When we look into the HR sector as with AI, AI algorithms make the task easier by auto-searching resumes, finding eligible internal candidates, identifying top performers, and analyzing the report of the shortlisted candidates which reduces the interview bias by making the task more effective. It has grown effectively growing from 2018 which is still growing. The major four areas of HR where AI is used the most are Recruitment, Engagement, Employment self-services, Employee Development, and Employee Attrition. In Recruitment, the decisions are taken at gut feeling for the final call of job selection are done without any support system. The major problem faced by hiring team managers is that 30 to 40 percent of their candidates are wrong. By using attract top talent LinkedIn, Glassdoor, Indeed, etc.. are popular job searching websites in which they use different types of machine learning techniques which recommend the jobs for the Job Seekers. For Screening and Shortlisting the resumes using Applicant Tracking Systems(ATS) makes the Screening task much faster than a manual process.

#### 1.2 AI in Financial Sector

By 2023, digital banking will reach from 75.8% to 78%,80% of banks are aware of the benefits provided by AI. AI in Finance sector has reached from chatbot assistants to fraud detection and task automation. Using AI which easily handles tedious tasks and parallel improves consumers' experience by offering 24/7 services for easy access to their financial accounts and even provides many financial services.AI is used in Personal Finance to manage one's financial health benefit.AI is used in Consumer finance in which it tries to prevent fraud and cyber attacks, wherein it easily tracks the irregularities in a pattern which most of the time remain unnoticed.AI is used in Corporate Finance in which it predicts and gives easy access to loan risks and it is used for Task Automation too.



Source: [shorturl.at/dfyG2](https://shorturl.at/dfyG2)

### 1.3 AI in Marketing

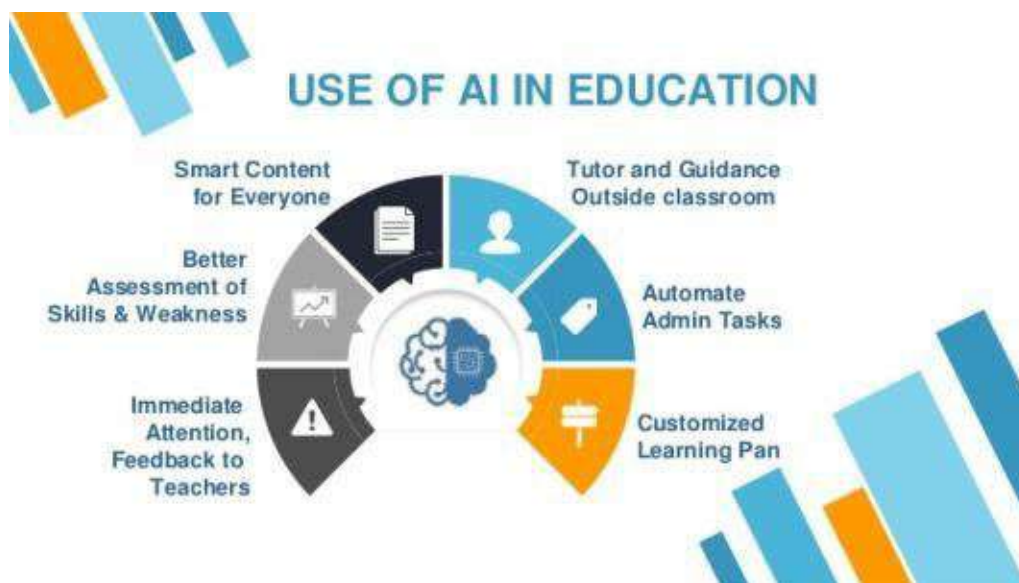
AI in marketing works for customer data it helps to track the next move of the consumers which helps to improve the customer life long journey. the usage of AI Sales teams was 29% in Marketing in the year 2018, but it has increased to 84% by 2020. AI is used by Starbucks to provide the services in a more personalized way. AI is used by Alibaba which operated on Fashion AI which was more effective to detect which product was been selected and smart mirrors which help to know the variation in different clothes. eBay has used AI for optimization they are driven through Marketing success. AMA boost newsletter engagement was improved using AI in which it was providing an individual level base interest and data.



Source: [shorturl.at/mqDI3](https://shorturl.at/mqDI3)

### 1.4 AI in Education Sector:

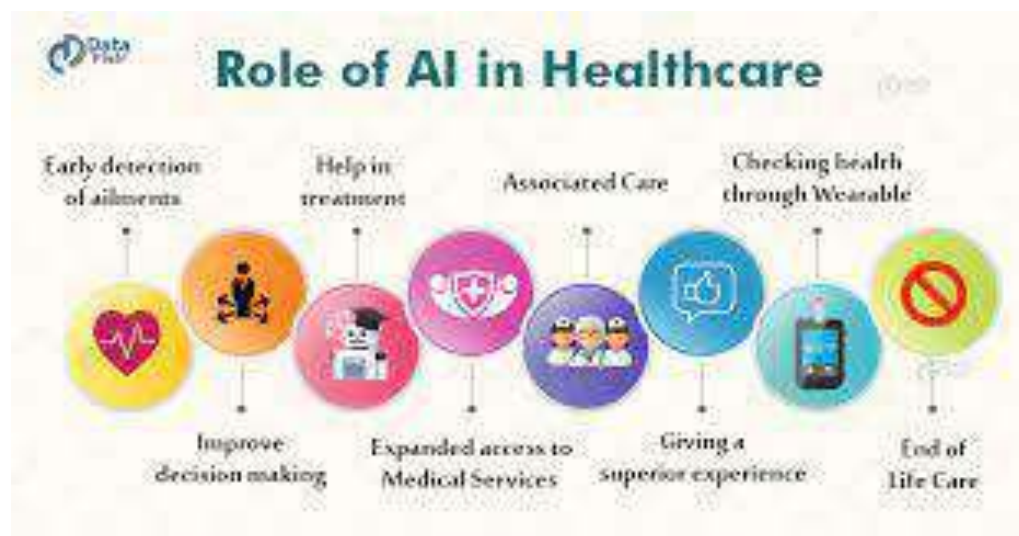
Internet and mobile devices have affected every one life. AI usage in the US will grow by 47.5 percent, but experts say it can't replace the teachers, Usage of AI globally in education is about to grow by 45 percent and the prediction is done that \$ 5.80 billion usages by 2025. Task Automation using AI will help the teachers to do the admin and teaching tasks more effectively. Universal access using AI will help the students to access the data globally, by not only focusing on it too having a presentation translator in which students can learn any new concepts by just understanding the subtitles of it. Smart Content Creation, digital lessons, information visualization are some different ways to make students be prepared at an effective level. AI also helps in identifying classroom weaknesses which helps teachers to reteach the material which students have not understood properly which help them to mark more accurately the students and adhere them with best teaching practices. 24/7 AI Assistance services to provide the student with any queries of them.



Source: [shorturl.at/hHI14](http://shorturl.at/hHI14)

### 1.5 AI in the Health care Sector:

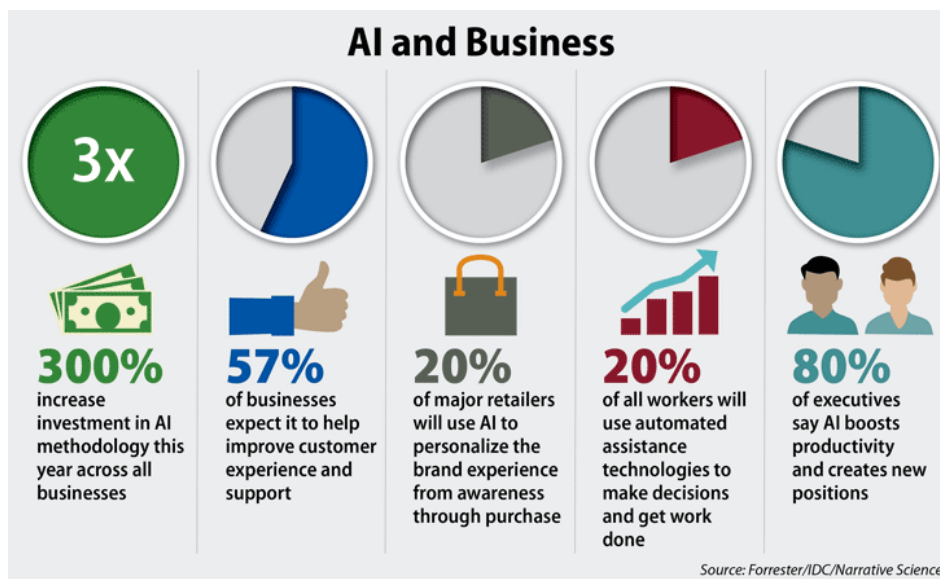
It simplifies the lives of the patients, doctors, and hospital administrative by performing tasks that are typically done by humans in less time and more effectively. It's considered the highest evolving industries value was about \$600 million in 2014 and it is about to reach \$150 billion by 2026. Early disease detection using AI in which it tries to notify quickly and save lives without losing the lives of patients unnecessarily. AI Deep Learning for Actionable Insights which analyzes using unstructured medical data to give better insights into a patient's real-time needs. Earlier Cancer Detection with AI in which they are using Freenome to detect cancer in much earlier stages.



Source: [shorturl.at/fim0I](http://shorturl.at/fim0I)

### 1.6 AI in Cooperate and Business Sector:

Current Trends has completely enhanced multiple sectors in business in which it created multiple new and creative jobs. some of them like Customer Relationship Management to manage the customer relationship in much smarter and more effective ways. Digital personal assistants which help to manage the AI bots can be used as personal assistants to help manage your emails, maintain your calendar, and even provide recommendations for the streaming process.



Source: [shorturl.at/bkD35](https://shorturl.at/bkD35)

### The main objective of our paper:

1. From a managerial perspective, what is artificial intelligence?
2. How will AI influence business strategy?
3. What are the major management risks from AI?
4. How each Management Sector enhances the techniques using Artificial Intelligence?

The paper is organized as in Section 2 its talks about related works, Section 3 we have described Research methodology, Section 4 about Results, and Section 5 concluded the paper and lastly, Section 6 explores References used in our study.

## 2. RELATED WORKS

With an advancement of AI which will be combined with unique human leadership traits such as creative thinking, best decision maker and innovative thinking to maximize the potential value of the leaders. In order to stay more effective leaders in the organization with an inheritance traits of AI which has enter labor markets, need to be more enhanced with how best AI they can integrate into their decision making process to utilize at its full potential at their level. Few of the recent study which has enhanced the usage of AI which has refine management by Kolbjornsrud, Amico and Thomas which states that 54% of time of Managers are wasted at administrative coordination and control [24], AI will save their time by making the task automative and faster which will help them to focus on task which will lead the managers to be more successful. By study of Chamorro-Premuzic, Wade and Jordan AI is more powerful in making decisions in which managers need to be focused more on traits like humanity adaptability, vision and engagement. In the study of McAfee, Goldbloom, Brynjolfsson and Howard AI meets the C-suite which will make human task more effective at top management roles to strengthen their creative and strategic decisions maker. In the study of Wallenberg he says integrated human with AI will make an effective management strategic having a great work experience overall. In the study of Björkman and Johansson which focus on future leadership using AI which will need of future leader to focus on motivating employees and facilitating teamwork and creativity with the organization.

### 2.1 RESEARCH GAP

1. Our Study has not only focused on impact of AI on management but also at different sector like education, business and Healthcare sector.
2. Our Study has tried to find the importance of usage at different sector.
3. Our Study also focused on different age sector and their interest in usage of the same

## 3. RESEARCH METHODOLOGY

In this paper, we have tried to analyze the overall view of AI in different sectors and the people of different sectors and to understand the level of acceptance of AI into their stream but based on the analysis we have found that depending on the age factors the acceptance level has changed below are the evaluated details. We

have created primary data by building a questionnaire and analyzing the same for the different age sectors and locations. In which we have analyzed the young generation and the even older generation are more active for the acceptance of AI into their professional life due to its flexibility and easy accessibility.

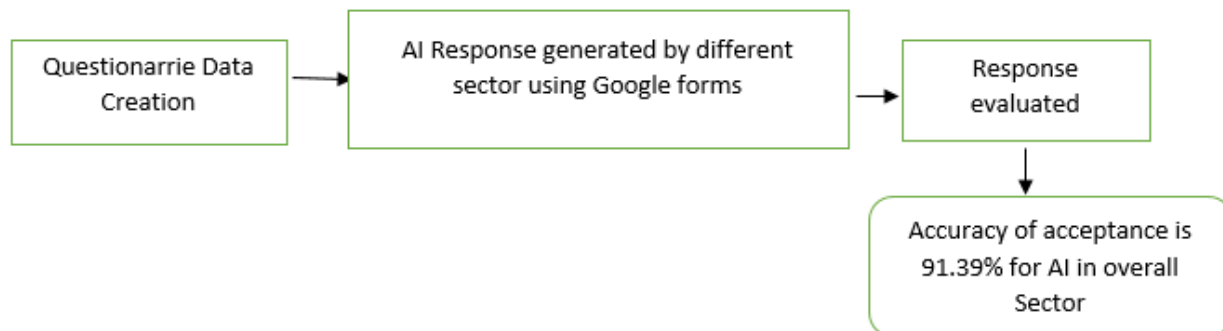


Fig1: Proposed Work

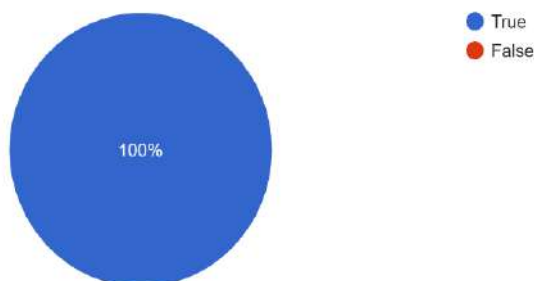
#### Steps Involved:

1. Created Primary data based on demographic location using a questionnaire.
2. Analyzed the same by using Google Analytics.
3. Acceptance accuracy was found 91.39 % for acceptance of AI at different sectors.

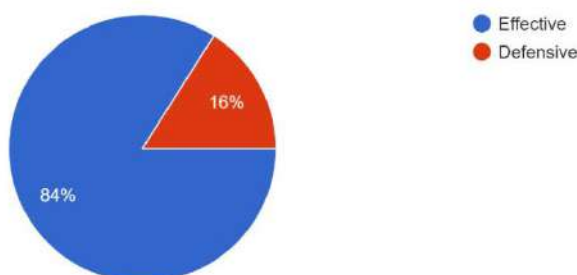
#### 4. RESULTS

Below are the results which was been mapped from the age sector of 18 to 60 to find the awareness and new job enhancement using AI. In maximum responses the Impact of AI in Future at different can achieved it by 91.39% by our studies which has mapped the different age sector and analyzed it.

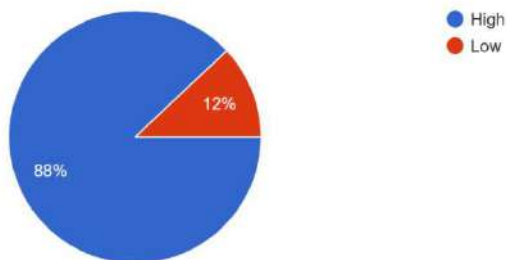
1. Is AI is about to Create Jobs or Reduce Jobs  
25 responses



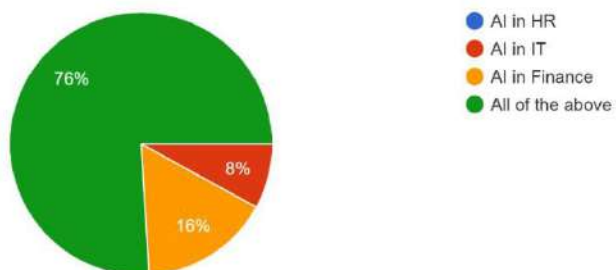
2. Impact of AI at different industrial sector is effective or defensive?  
25 responses



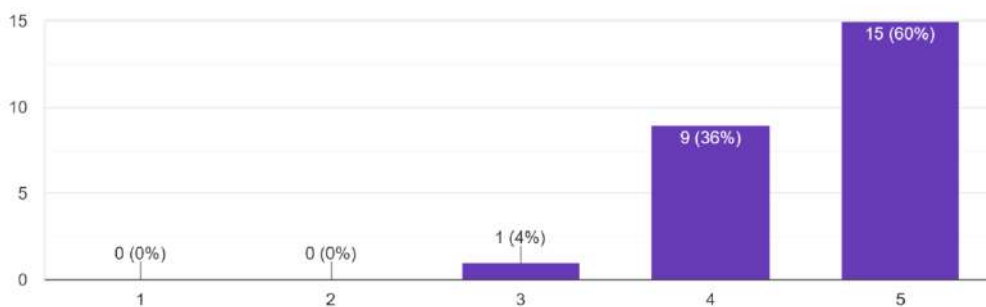
3. How will AI influence business strategy?  
25 responses



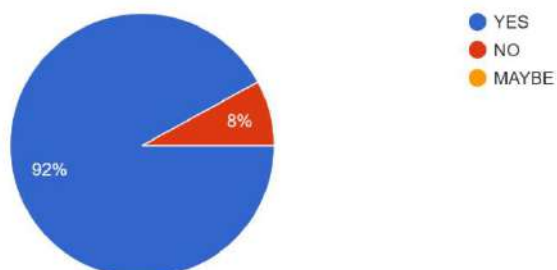
4. How each Management Sector enhances the techniques using Artificial Intelligence?  
25 responses



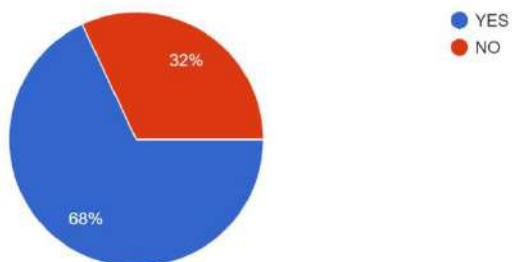
5. Can AI provide new economic opportunities for the country  
25 responses



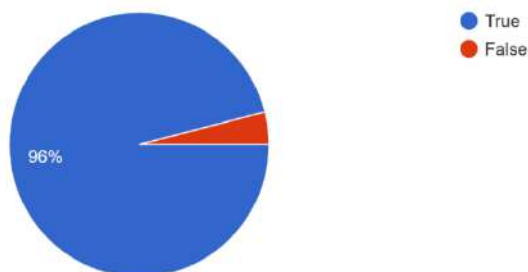
6. Are you interested to use AI techniques in your daily life  
25 responses



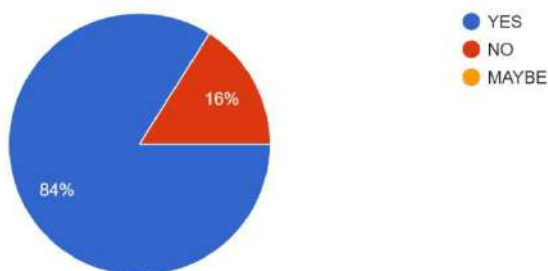
7. AI can make people happier  
25 responses



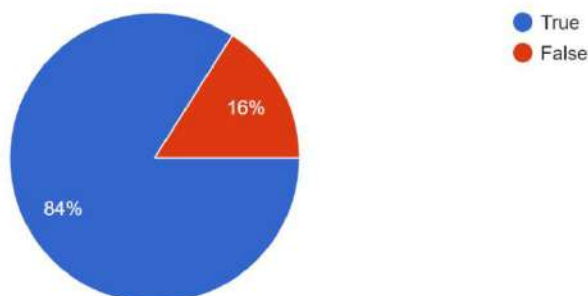
8. AI can perform better than teachers, humans, doctors and lawyers etc..  
25 responses

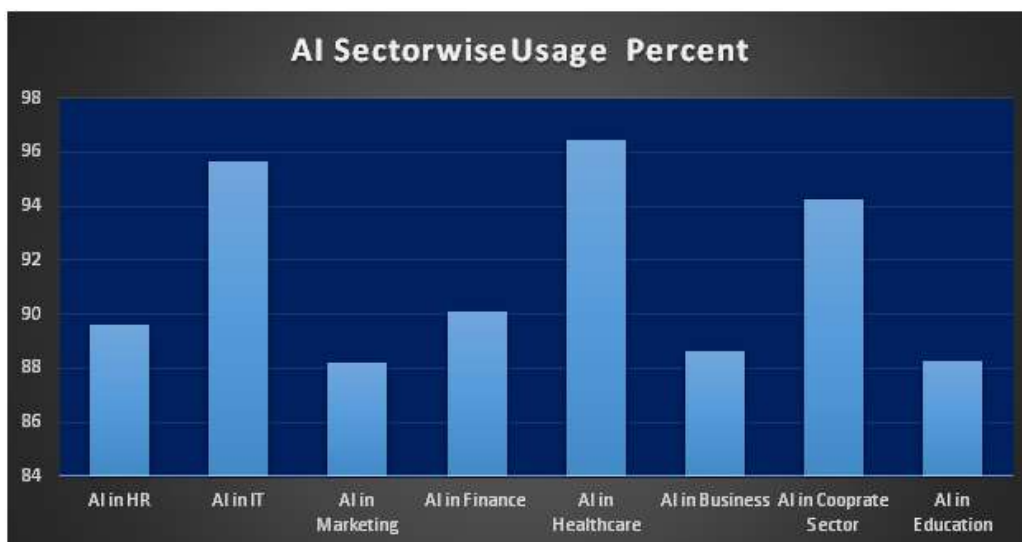


9. Does AI will enhance skills in future  
25 responses



10. AI is used as to keep spy on people  
25 responses





**Fig2:** Above figure show the impact produced by our study at different sector and by an average our study have achieved 91.39% for the same

## 5. CONCLUSION

Our work has focused on the impact of AI at different sectors in which we have found an accuracy of 91.39% acceptance level at different sectors using AI. With this, we make a conclusion that AI is going to be a bright future for all the domains ahead. So insights that AI has to be enabled as a core tool of their sectors. Our study will help the different sector to actually understand that AI will be always Effective in their different work level.

## 6. REFERENCES

1. <http://surl.li/blnus>
2. What Managers Need to Know About Artificial Intelligence, David Kiron
3. <https://www.weforum.org/agenda/2018/09/artificial-intelligence-shaking-up-job-market>
4. <https://empxtrack.com/blog/artificial-intelligence-in-hr/#:~:text=AI%20algorithms%20simplify%20the%20task,This%20even%20eliminates%20interview%20bias.>
5. <https://www.businessinsider.com/ai-in-finance?IR=T>
6. [https://blog.socialmediastrategiessummit.com/10-examples-of-ai-in-marketing/#:~:text=Artificial%20intelligence%20marketing%20\(AI%20Marketing,better%20ways%20to%20do%20that.](https://blog.socialmediastrategiessummit.com/10-examples-of-ai-in-marketing/#:~:text=Artificial%20intelligence%20marketing%20(AI%20Marketing,better%20ways%20to%20do%20that.)
7. <https://trainingmag.com/top-7-ways-artificial-intelligence-is-used-in-education/#:~:text=AI%20helps%20teachers%20up%20their,and%20impact%20the%20students%20better.>
8. <https://builtin.com/artificial-intelligence/artificial-intelligence-healthcare>
9. <https://www.businessnewsdaily.com/9402-artificial-intelligence-business-trends.html>
10. Brynjolfsson E. & McAfee A. (2014). The second machine age: Work, progress, and prosperity in a time of brilliant technologies. New York, NY: WW Norton & Company.
11. Brynjolfsson E. McAfee A. (2012). Race Against the Machine: How the Digital Revolution is Accelerating Innovation, Driving Productivity, and Irreversibly Transforming Employment and the Economy. Lexington, Massachusetts: Digital Frontier Press.
12. Computer Law & Security Review, 32(5), pp. 749-758. Dejoux C. Léon E. (2018). Métamorphose des managers. 1st edition. France: Pearson.
13. Dirican C. (2015). The Impacts of Robotics, Artificial Intelligence On Business and Economics. Procedia -Social and Behavioral Sciences, 195, pp 564-573.
14. Epstein S. (2015). Wanted: Collaborative intelligence. Artificial Intelligence, 221, 36-45. Ford M. (2015). The Rise of the Robots: Technology and the Threat of Mass Unemployment.



15. London: Oneworld Publications. Galbraith J. (2014). Organization design challenges resulting from Big Data. *Journal of Organization Design*, 3(1), pp. 2-13.
16. Gurkaynak G. Yilmaz I. Haksever G. (2016). Stifling artificial intelligence: Human perils.
17. Hengstler M. Enkel E. Duelli S. (2016). Applied artificial intelligence and trust – The case of autonomous vehicles and medical assistance devices. *Technological Forecasting & Social Change*, 105, pp. 105-120.
18. 11. Jarrahi M. (2018). Artificial intelligence and the future of work: Human-AI symbiosis in organizational decision making. *Business Horizons*, vol. 61, no 4, pp. 577-586.
19. Kornienko A.A. Kornienko A.V. Fofanov O. Chubik M. (2015). Knowledge in artificial intelligence systems: searching the strategies for application. *Procedia - Social and Behavioral Sciences*, 166, pp. 589-594.
20. Olsher D.J. (2015). New Artificial Intelligence Tools for Deep Conflict Resolution and Humanitarian Response. *Procedia Engineering*, 107, pp. 282-292.
21. 14. Snow C.C. Fjeldstad Ø.D. Langer A.M. (2017). Designing the digital organization. *Journal of Organization Design*, 6(7), pp. 1-13
22. Wauters M. Vanhoucke M. (2015). A comparative study of Artificial Intelligence methods for project duration forecasting. *Expert Systems With Applications*, 46, pp. 249-261
23. Artificial Intelligence's Impact on Management, MALIN ERIKSSON CAMRAN DJOWEINI, Sweden 2020.

## **An Empirical Study of Classifying Learners on Imbalanced Data Set**

**Prabha Siddhesh Kadam<sup>1</sup> and Girish Tere<sup>2</sup>**

<sup>1</sup>Department of Computer Science, Kirti M. Doongursee, Mumbai, India

<sup>2</sup>Department of Computer Science, Thakur College, Kandivali Mumbai, India

### **ABSTRACT**

Educational institutes always eager to improve the results of the students. The HEI also ask about the slow learners and advance learners and the activities colleges initiates to enhance the learning of the slow learners. The tree base algorithms work well on categorical data able to classify records with high accuracy but main hurdle in the process is the imbalanced classes. The study accepts the sample size 584 to classify the learner types. Outcomes shows 97.16% accuracy with Random Forest classifiers as a base learner in ensemble approach where SMOTE class balancing technique implemented in pre-processing stage to balance imbalance classes. The model performs multiclass classification in classes namely advance learner, average learner, and slow learners.

Keywords: Machine learning, imbalance dataset, under sampling, over sampling, SMOTE.

### **1. INTRODUCTION**

Mentoring students is a big task and mentoring many candidates in a semester is bit difficult. The classification of learner using the automate system can makes it easy at some extends. The learning management system allows to store student's academic records and learning algorithms can learn using those record sets. The student supposes to classify as advance learners, average learner, or slow learners. The main problems researchers faced when the classification comes under the domain of multiclass classification. It was observed in the literature that a smaller number of samples in one class creates bias in the prediction. The student's records are not exception for this, the most of the time learners comes under the class average learners while less number candidates belongs to the category of advance learner or slow learners. To reduce the drop out number of students it is necessary to classify those candidates, who are week in learning and help them in study to improve performance. But due to small size of class the records can get misclassified or treated as a noise by the learning algorithm. The solution for this makes those classes balance. There are techniques using which researchers can balance those unbalance classes and then apply the required algorithm on it, so that it will return the acceptable outcome. In this system, records of Computer Science undergraduate students collected using survey. The system trains from the academic record of the student's previous semesters, and entry level score. The record set get treated and the model classify the learner in the best suited class.

The seven section allows to divide the work. The chapter two stands for literature review. The aim behind the study listed in the third chapter, objective. Chapter four is for research methodologies. The conclusion and results included in the chapter five. The chapter six is dedicated for future scope of the study. The last chapter seven holds references.

### **2. LITERATURE REVIEW**

Learning techniques like ensemble mechanism, supervised unsupervised learning brings new ways to deal with hurdles in the teaching learning domain. The major task like student recommendation for placement drives, early prediction of drop out students and the succusses prediction using log details of online platform or learning management system is possible and became simple.[5] where correct features must get used to improve accuracy of model. The accuracy is the evaluation metric used to decide performance of the model developed under the study. When multiclass classification takes place, the overall accuracy going to be bias. It happens because of the class with more sample size usually shows high accuracy. The class with a smaller number of records can lead towards inferior performance. Thus, the other evaluation metrics like recall, precision, F-measure considered to evaluate performance of individual class. F1 score stands reliable when all classes supposed to be considered while designing the model. For a single class significance precision is highly preferable one. [6] Researcher Chawla et al. (2002) tried to resolve the problem of imbalance classes with the help of two different approaches where authors reduced the sample size of majority classes and raise the number of samples in the minor classes. [3] Author Y. Kamei et al. (2007) worked using SMOTE, under sampling, over sampling and deal with single class. Researchers balanced the classes and then apply tree base classification approach and neural network on the data set but found no significant improvement in the outcome while the other two algorithms namely logistic regression and linear discrimination analysis return improved results. [7] while balancing the record set SMOTE may introduced some noise, still it was observed by the researcher Y.

Mi et al. (2013) SVM (Support Vector Machines) gave outstanding results after implementation of SMOTE on the record set. [8] The similar study was performed by D. Thammassiria et al. (2013) were the SVM returned better results and proved that SMOTE is the right choice comparative to the other two approaches over sampling and under sampling. [1] L. Zhou et al. (2013) tried these techniques on different size of datasets and found that method must be selected based on sample size of training set, while the SMOTE is choice for large data sets. [2] Prabha Kadam and Girish Tere (2021) implemented SMOTE on dataset for multiclass classification and balanced the record sets to avoid bias in the outcome.[4][5]

### 3. OBJECTIVE

The objectives of proposed study are as follows –

1. To study class balancing techniques to enhance prediction power of model.
2. To perform comparative study of multiple model design using machine learning algorithms for classification of learners.
3. To propose a near-to-precise prediction model to detect slow learners in computer science course.
4. To evaluate performance of proposed model.

### 4. METHODOLOGY

The record set created by collecting records from first year completed undergraduate computer science students within Mumbai region. The 584 samples collected from survey using google platform and through progress report files. Total nineteen attributes used under the study in which the grades of the student from first semester and second semester subjects gets consider as well as the marks scored in the subject physics, mathematics and statistics, and English at higher secondary level also consider under the study. The questions like how many hours learner spend on self-study, does learner comes under earn while learn category, attendance for lectures in college also considered as one parameter for classifying learners. Other attributes like on time submission of assignments, projects and other class work, educational gap during course, and disability if any also treated as parameters for the classification problem. The distribution of samples in the three classes returns us 88 samples of type advance learners, 90 samples belong to slow learner class, while the remaining 406 samples treated as a part of the average learner class.

The study was performed in three ways, first with the SMOTE as a technique to balance the class by generating synthetic samples, second by reducing the majority class to the level of minor class and the third case without applying any class balancing mechanism on the dataset.

The 70-30 data split used for training and testing purpose.

The approach in which minority class samples are being still as it is but majority class samples get selected randomly and class size reduced, also named as random under sampling. Due to this approach sample size reduced to the 264, every class hold 88 samples. Generating the sample is clever idea because while reducing to the lower-class may lose some information which can contributes towards prediction. In small size data sets every record matters a lot, such situation does not afford the down sampling. Synthetic Minority Oversampling Technique (SMOTE) generates sample points using the neighbourhood approach.

The machine learning algorithms applied on the record set after the pre-processing are as below.

**Decision Tree:** It is also known as structured classifier which generates rules for the classification of the instance from the data set. The graphical representation of the tree structure makes the learning process simple if the tree has small size. The major problem with this structure is overfitting but it can be handled by the hyperparameter tuning.

**Extra Tree:** Extremely Randomized Tree Classifier, the approach in which forest generates using de-correlated decision trees. The number of trees to be generated can be controlled using the estimator parameter in the algorithm. The boot strap approach allows to reuse the samples from the dataset if value set to true.

**Random Forest:** Multiple decision trees form a forest the same logic used for building this algorithm. The outcome is a combination of multiple decision trees from a random choice. The mean operation used to calculate the outcome allows to reduce the overfitting and returned the average accuracy.

**Bagging:** Random sample selection make it famous. Meta estimator which fit on base classification algorithms using the randomly selected records. The voting and mean are the two techniques gives choice to the

programmer for final prediction calculation in this approach. The Decision Tree Classifier plays default role of base learner in the technique.

**AdaBoost:** Boosting the accuracy of the algorithm is the main agenda of this method. Adaptive boosting is also combines multiple models to improve accuracy but weighted mechanism implemented in this approach makes it different than the other ensemble learning algorithms.

### 5. RESULTS & CONCLUSION

The result of tree base classifier namely Decision Tree (DT), Extra Tree (ET), Random Forest (RF) are given in the table 1. The table1 shows the outcome of the algorithms, where the classes balanced with the SMOTE in the pre-processing stage as well as the hyperparameter tuning also performed to reduce overfitting. The results shows that difference exist between the training accuracy and testing accuracy but model built using boosting technique with combination of random forest returned accuracy 97.16% was good compared to the other models.

SMOTE		RF	DT	ET	W_SMOTE		RF	DT	ET
Boosting	Training Accuracy	99.88	100	98.70	Boosting	Training Accuracy	99.75	100	96.57
	Testing Accuracy	<b>97.16</b>	94.89	<b>93.75</b>		Testing Accuracy	96.02	91.48	86.93
Bagging	Training Accuracy	99.17	99.88	99.05	Bagging	Training Accuracy	98.52	99.26	91.17
	Testing Accuracy	96.02	<b>96.59</b>	92.61		Testing Accuracy	<b>96.59</b>	<b>95.45</b>	90.34
Algorithm	Training Accuracy	99.29	99.05	99.05	Algorithm	Training Accuracy	99.26	97.55	94.85
	Testing Accuracy	96.59	94.32	92.61		Testing Accuracy	96.02	91.48	<b>92.05</b>
<b>Table 1.</b> Results of Class balancer SMOTE on ML algorithms.					<b>Table 2.</b> Results of ML algorithms without Class balancing.				

DOWN_SAMPLING		RF	DT	ET					
Boosting	Training Accuracy	98.91	100	99.46					
	Testing Accuracy	90	<b>95</b>	95					
Bagging	Training Accuracy	97.28	99.46	98.37					
	Testing Accuracy	<b>95</b>	93.75	<b>96.25</b>					
Algorithm	Training Accuracy	98.91	98.37	98.37					
	Testing Accuracy	93.75	92.50	95					
<b>Table 3.</b> Results of ML algorithms with under sampling					<p><b>Figure 1.</b> Max Accuracy marked in the three approaches</p>				

The numbers in the Table 2 shows results of the machine learning techniques implemented on the data set without performing class balancing but with hyperparameter tuning. In this case bagging model with random forest as a base learner reached till mark of 96.59% accuracy. While the table 3 results obtained after down sampling the record set to the minor class. The results show the maximum accuracy in this case returned by the bagging Extra Tree 96.25%.

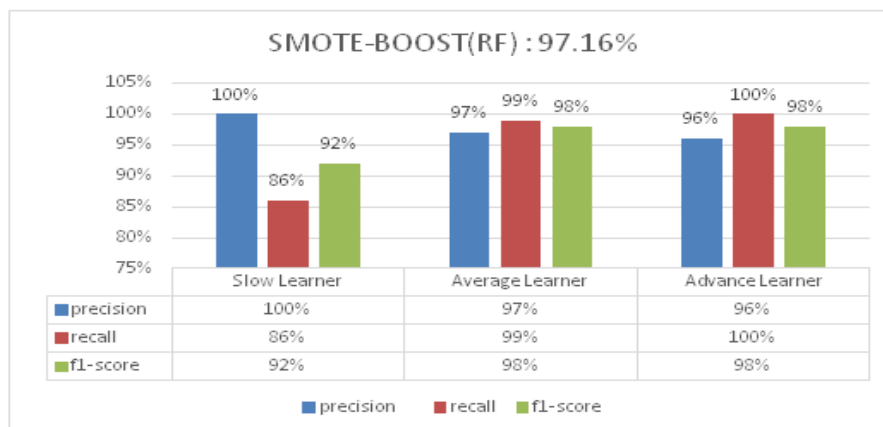


Figure 2. Evaluation Matrix for SMOTE-BOOST(RF)

Figure 2 shows the other evaluation metric for the model with highest accuracy 97.16%. The F1 score of the model for classifying average learner and advance learner is 98% while it reached till 92% for slow learner.

The outcome from three different approaches implemented in the study clears that the class balancing is essential step in tree base algorithms to avoid bias. The oversampling using SMOTE helps to increase accuracy compared to the under-sampling approach. Hyper parameter tuning also contributes to avoiding overfitting.

## 6. FURTHER SCOPE

This study will help faculties and college administrators for student's classification. Mentoring of selected students will be easier and more specific in this scenario which will helps to improve program outcome and program specific outcome. There are multiple subject domains in the course and detailed study is possible for each domain.

## 7. REFERENCES

1. D. Thammasiria , D. Delenb,, P. Meesadc and N. Kasapd, "A critical assessment of imbalanced class distribution problem: The case of predicting freshmen student attrition," Expert Systems with Applications, 2013
2. L. Zhou, "Performance of corporate bankruptcy prediction models on imbalanced dataset: The effect of sampling methods", Knowledge-Based Systems, vol. 41, pp. 16–25, 2013 ("Corporate Bankruptcy Prediction Using Machine Learning ...")
3. N. V. Chawla, K. W. Bowyer, L. O. Hall, and W. P. Kegelemer, "SMOTE: Synthetic Minority Over-Sampling Technique," Artificial Intelligence Research, vol. 16, pp. 321-357, 2002
4. Prabha Kadam, Girish Tere, "An Ensemble Approach for Early Detection of At-Risk Students", GIS Science Journal, Volume 8, Issue 6, 2021, ISSN No: 1869-9391
5. Prabha Kadam, Vinod Vaze, "Early Detection of Prone to Failure Student Using Machine Learning Techniques", Bioscience Biotechnology Research Communications (Special issue on Emerging Research on Management, Sciences and Technology) Volume 14(05) 2021 ISSN No: 0974-6455
6. Shaza M. Abd Elrahman1 and Ajith Abraham, "A Review of Class Imbalance Problem", Journal of Network and Innovative Computing, Volume 1 (2013) pp. 332-340, ISSN 2160-2174
7. Y. Kamei, A. Monden, S. Matsumoto, T. Kakimoto and K. Matsumoto," The Effects of Over and Under Sampling on Fault-Prone Module Detection," IEEE, pp. 196-204, 2007.
8. Y. Mi, "Imbalanced Classification Based on Active Learning SMOTE," Research Journal of Applied Science Engineering and Technology, vol. 5, pp. 944-949,2013.

## Expert System for Sanskrit Grammar

Pratibha Mangesh Jadhav and Gauri Chetan Deshpande  
C.K. Thakur ACS College, New Panvel (Autonomous), India

### 1. ABSTRACT

Today the computation tool provides an easy platform for learning difficult languages like Sanskrit effectively. This learning can be very helpful to students. An expert program is a comprehensive computer intelligence tool that tries to solve a problem. It has been gaining traction over the past decades because of the better integration sites available on personal computers. The goal of the study is to introduce an expert system that can find solutions to students' problems regarding translation, Sandhi classification, and interpreting images with Sanskrit alphabet sets. In this study, a Python-based expert system was designed and implemented.

Keywords: Expert system, Python, Sanskrit language, Translation, Sandhi

### 2. INTRODUCTION

Sanskrit language is the composition of religious texts like the Mahabharata and the Ramayana. Many modern-day languages like English, Spanish, and Japanese, have accomplished greater positions in education but in this modern age Currently, Sanskrit is being regarded as a pure grammar and scientific language. Sanskrit is deeply rooted in our culture, and it is internationally acknowledged. This language gained a lot of popularity because of its philosophical features and influenced many Indian and Southeast Asian languages. In comparison with other languages, Sanskrit has the largest vocabulary and is able to convey the most meaning in the fewest words. To study this language, one requires calmness of mind, patience and devotion for the language. However, expert systems are now developing as prevailing instruments in piloting a new period of universal revolution in modern education for all types of progress in the society. The right tool to preserve and promote traditional Sanskrit studies is expert systems. Many schools adopted Sanskrit as an elective subject. AS well new education policies adopted Sanskrit language as compulsory subject in primary schools. While learning this language, learners get some difficulties like transliteration, Sandhi splitting etc. The study presents expert system that provides solutions for learners.

### 3. LITERATURE REVIEW

A previous study focused on Sanskrit grammar like machine-based transliteration, Sandhi Splitting, analysis of various language transliterations etc. These methods were described by various computational techniques. To translate any language into another, a transliteration tool is used. This tool was applied to translate the Sanskrit into Hindi language with the help of a rule-based approach. [9] Also same approach was applied to translate text with English and Sanskrit pair using speech recognition techniques [3]. This study [5] reported comparative study analysis on different translation services; rule-based, corpus-based, and direct for ML. Various Indian ML methodologies have been studied for Sanskrit languages [2]. The Corpus-based translation system was applied to translate Sanskrit and Hindi pair. [8]. Grammar terms in both English and Sanskrit, like nouns and verbs, were used. The whole structure for Rule-based translation and Example-based translation was described in detail for source and target language pair. [12] A Sandhi is a technique by which two or more words are joined together. Sandhi viccheda means splitting words or sentences into its constituents. Using these techniques, the Bhagwat Geeta was split into words [1]. An algorithm based on panini's complex codifications rules was used for sandhi formation using morphological analysis [11]. Rule based algorithm was used to sandhi viccheda for Hindi compound words [10]. Object detection was classified objects and behaviours. All object detection techniques were categorized on based on shape, texture and motion.[13]. The applications of object detection have been summarized [14].

### 4. OBJECTIVES

- Transliteration of English word to Sanskrit word
- Sandhi Splitting
- Describe image in Sanskrit language.

### 5. DESIGN, IMPLEMENTATION AND RESULTS

#### 4.1 DESIGN

A computerized expert system simulates the capability of humanoid experts to make decisions. Expert systems are designed to solve complex problems by reasoning based on a set of knowledge that is primarily expressed as rules rather than traditional procedural codes.

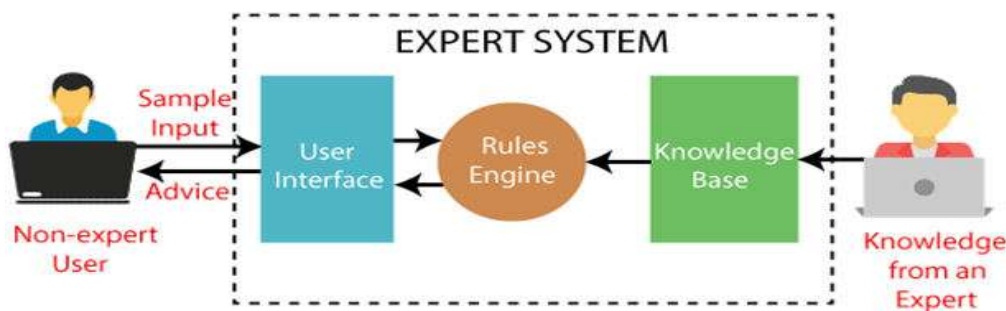


Fig. 1: Component of expert system

- User interface:** Non expert users need this to learn how the expert system works and easily identify resolutions. Python language was used for this study to develop User interface.
- Inference Engine:** Inference engine tries to match the condition (IF) part of each rule in knowledge base with facts currently available in the working memory.
- Knowledge base:** The knowledge base in an expert system represents facts and rules. It contains knowledge in specific domains along with rules 5 in order to resolve problems, and form procedures that are relevant to the domain.

#### 4.2 METHODS OF DATA COLLECTION

This study opted questionnaire method based on qualitative questions to get learners' difficulties. 10 In this study 150 learner's data were collected from different high schools of New Mumbai. This questionnaire consists of following questions:

- Do you like Sanskrit languages?
- Why have you selected Sanskrit language?
- Do you need subject teacher or any special instructor to solve your Sanskrit language queries?
- Can you easily describe the given picture in Sanskrit Language?(if no then specify your difficulties)
- Can you easily translate Sanskrit word/sentences into other language? (If no then specify your difficulties)
- Can you easily identify singular or plural word? (If no then specify your difficulties)
- Can you easily make the word from Splitting letters 11 and vice versa? (If no then specify your difficulties)

#### 4.3 DATA ANALYSIS

In this survey, most children had difficulties with translation, Sandhi Splitting, and Image description 9 in Sanskrit language. These difficulties were evaluated using Chi-Square hypothesis analysis.

Hypothesis Test Summary				
	Null Hypothesis	Test	Sig.	Decision
1	The categories defined by Do you like Sanskrit languages = 1,000 and 0,000 occur with probabilities 0.5 and 0.5.	One-Sample Binomial Test	.000	Reject the null hypothesis.
2	The categories defined by Do you need subject teacher or any special instructor to solve = 0,000 and 1,000 occur with probabilities 0.5 and 0.5.	One-Sample Binomial Test	.001	Reject the null hypothesis.
3	The categories defined by Can you easily describe the given picture in Sanskrit Language = 1,000 and 0,000 occur with probabilities 0.5 and 0.5.	One-Sample Binomial Test	.462	Retain the null hypothesis.
4	The categories defined by Can you easily translate Sanskrit word/sentences into other language = 0,000 and 1,000 occur with probabilities 0.5 and 0.5.	One-Sample Binomial Test	.462	Retain the null hypothesis.
5	The categories defined by Can you easily identify singular or plural word if no then specify = 0,000 and 1,000 occur with probabilities 0.5 and 0.5.	One-Sample Binomial Test	.209	Retain the null hypothesis.
6	The categories defined by Can you easily make the word from Splitting letters and vice versa = 0,000 and 1,000 occur with probabilities 0.5 and 0.5.	One-Sample Binomial Test	.063	Retain the null hypothesis.

Asymptotic significances are displayed. The significance level is .05.

Fig. 2: Hypothesis Test Summary

A one-sample binomial test 1 was used to test hypotheses based on Sanskrit language difficulties and school factors. From the above summary table, 7 it can be seen that learners from different schools faced different difficulties like translation, finding the singular or plural word, image description, and Sandhi splitting. Expert system has developed after identifying the difficulties learners encounter with Sanskrit grammar.

#### 4.4 Proposed Expert System

A Sanskrit grammar expert system developed by data analysis. Python programming is used for developing Expert System that having various advanced libraries and modules. This expert system consists of three modules:

- **Translation of English word into Sanskrit Word**

A script written in one language is converted into another is called as translation. In proposed work, this tool was developed to transliterate English into Sanskrit word. A dataset was designed that included English words along with their Sanskrit meanings. Following diagram shows working of transliteration.



Fig. 3: Transliteration model

The expected outcome of translation from English to Sanskrit is as follows:

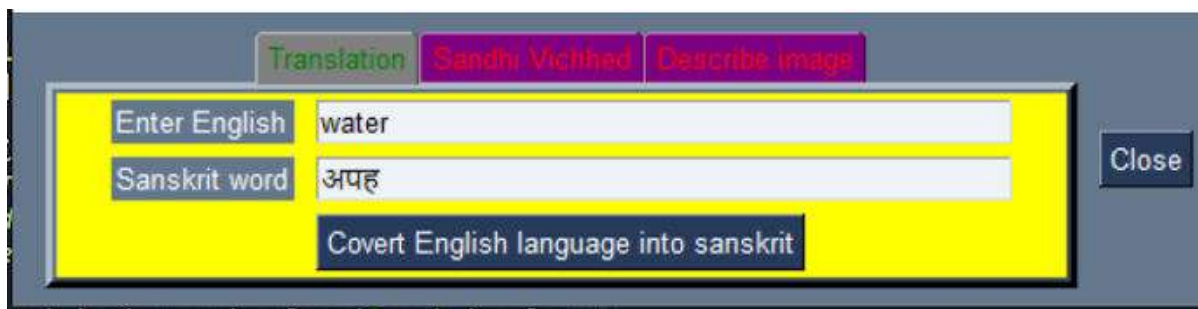


Fig. 4: Translation of English word into Sanskrit Word

- **Sandhi Splitting**

Sanskrit\_parser is a Python module that supports three different uses of Sanskrit like morphological analysis of the word, word splitting, and syntactic analysis of the sentence.

Sanskrit\_parser is a python module that analyses Sanskrit grammar in three different ways: morphologically, by splitting words and by analyzing syntactically. Sanskrit\_parser module also splits the word. The expected outcome of Sandhi Splitting is as follows:

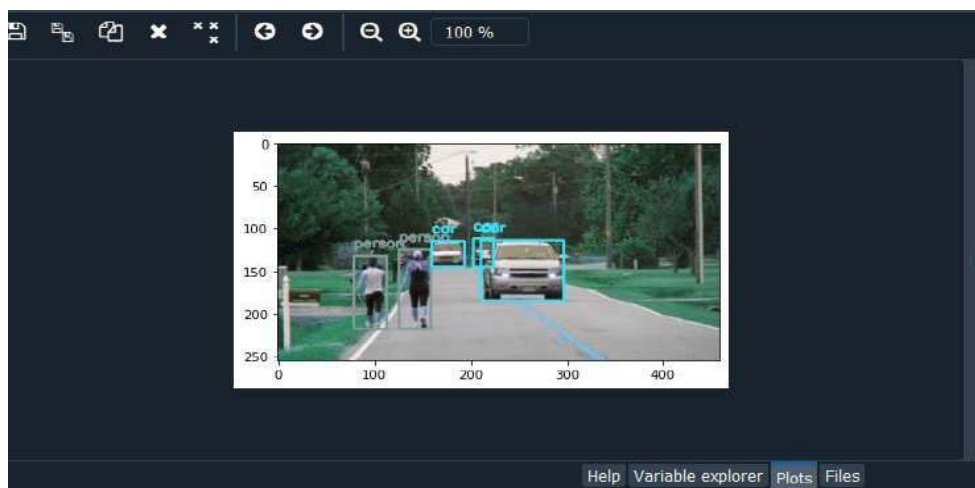


Fig. 5: Sandhi Splitting

- **Describe image in Sanskrit language.**

This module was developed using the OpenCV library of python. Using an input image, the objdetect module of OpenCV used to detect the object and caption it in English. The expected outcome of detecting object is as follows:





**Fig. 5:** Detecting objects

Using caption and result image, formed a small sentence in English and translated it to Sanskrit

## 6. CONCLUSION

The expert systems are increasingly used and seen as a powerful tool for solution of complex problems. Sanskrit grammar, one of the hardest aspects of the language, was addressed in this expert system using Python. This expert system was capable to translate English word into Sanskrit text, Sandhi splitting and identify objects of image and translate it in Sanskrit. Future work will include morphological analysis as well as translation of large sentence English into Sanskrit.

## REFERENCES

1. Bhagyashree Patil & Manoj Patil (2018). Implementation of Sandhi Viccheda for Sanskrit Words/ Sentences/ Paragraphs. *International Journal of Computer Sciences and Engineering*. Vol-6, Issue-9, 355-360.
2. Deepak Mane & Aniket Hirve (2013). Study of Various Approaches in Machine Translation for Sanskrit Language. *International Journal of Advancements in Research & Technology*, Volume 2, Issue 4, 383-387.
3. Dr. Pragya Shukla & Akanksha Shukla (2013). A Framework of Translator from English Speech to Sanskrit Text. *International Journal of Emerging Technology and Advanced Engineering*. Volume 3, Issue 11, 113-121.
4. Dzmitry Bahdanau, Kyunghyun Cho, and Yoshua Bengio. 2014. Neural machine translation by jointly learning to align and translate. *arXiv preprint arXiv:1409.047* (2014).
5. Jaideepsinh K. Raulji & Jatinderkumar R. Saini (2016). Sanskrit Machine Translation Systems: A Comparative Analysis. *International Journal of Computer Applications*. Volume 136 – No.1, 1-4.
6. Karpathy, Andrej, and Li Fei-Fei. "Deep visual-semantic alignments for generating image descriptions." *Proceedings of the IEEE conference on computer vision and pattern recognition*. 2015.
7. Lin, Tsung-Yi, et al. "Microsoft coco: Common objects in context." *European conference on computer vision*. Springer, Cham, 2014.
8. Muskaan Singh et. al. (2019). Corpus based Machine Translation System with Deep Neural Network for Sanskrit to Hindi Translation. *International Conference on Computational Intelligence and Data Science*, 2534-2544.
9. Prateek Agrawal & Leena Jainb (2019). Anuvaadika: Implementation of Sanskrit to Hindi Translation Tool Using Rule-Based Approach. *Recent Patents on Computer Science*. 12, 1-16.
10. Priyanka Gupta & Vishal Goyal (2009). Implementation of Rule Based Algorithm for Sandhi-Vicheda of Compound Hindi Words. *International journal of Computer Science Issues*, Volume 3, 45-49
11. Ravi Pal & Dr. U. C. Jaiswal (2012). Design & Analysis of an Exhaustive Algorithm for Sandhi Processing in Sanskrit. *International Journal of Engineering Research and Development*. Volume 4, Issue 8, 33-36.

12. Rathod S.G., "Machine Translation of Natural Language using different Approaches: ETSTS (English to Sanskrit Translator and Synthesizer)", International Journal of Computer Applications, Vol 102-No.15, September 2014.
13. S. Manjulaa & Dr. K. Lakshmi(2016). A study on object detection. International Journal of Pharmacy & Technology, Volume 8 , Issue 4,22875-22885.
14. Sunil & Gagandeep (2019). Study of Object Detection Methods and Applications on Digital Images. International Journal of Scientific Development and Research, Volume 4, Issue 5,491-497.
15. Peter Anderson, Xiaodong He, Chris Buehler, Damien Teney, Mark Johnson, Stephen Gould, and Lei Zhang. 2018. Bottom-up and top-down attention for image captioning and visual question answering. In Proceedings of the IEEE Conference on Computer Vision and Pattern Recognition (CVPR'18).
16. Thorsten Brants, Ashok C. Popat, Peng Xu, Franz J. Och, and Jeffrey Dean. 2007. Large language models in machine translation. In Proceedings of the Joint Conference on Empirical Methods in Natural Language Processing and Computational Natural Language Learning (EMNLP-CoNLL'07). 858–867.
17. Alberto Fernández Villán, Mastering OpenCV 4 with Python, March 2009, ISBN: 9781789344912, Packt Publishing Limited, 256-359
18. Krishna Bhavsar, Natural Language Processing with Python cookbook, November 2017, ISBN-10: 9781789130386, Packt Publishing Limited, 110-262
19. Brett Lantz, Machine Learning with R, July 2015, ISBN: 978-1784393908, Packt Publishing, 56-123
20. Manaranjan Pradhan, Machine Learning using Python, January 2019, ISBN-978-8126579907, Wiley, 90-128
21. J. Chowdhury, Sanskrit Tutor, December 2006, ISBN-978-8130704197, Cosmo Publication, 1-58

## Computational Social Choice A Mutually Enriching Alliance between Computer Science & Social Choice Theory

Pratik A. Desai

MCA, DES' NMITD, University of Mumbai, India

### ABSTRACT

This paper introduces Computational Social Choice, as a relatively new inter-discipline that emerged towards the end of 20<sup>th</sup> century. Computational Social Choice studies the problem of collective decision making, as originated in political science and economics, from the perspective of computer science. The paper starts by introducing the readers to the classical social choice theory, the problems it deals with and the axiomatic framework developed by Kenneth Arrow in the mid twentieth century that enabled a more rigorous mathematical analysis of various methods developed for computing social choice from individual preferences. It describes various voting methods to illustrate the non-triviality of seemingly simple social choice problems. Lastly it briefly describes why such social choice problems are relevant to computer science and computing systems, in particular the various applications of social choice methods and theory in engineering of computing systems & applications. Contrariwise, the contributions that computer science has made and can potentially make to the study of social choice problems in general, is also briefly described.

Keywords: computational social choice, social choice, impossibility theorems, preference aggregation, voting rules, collective decision making, multi-agent systems, mechanism design.

### 1. INTRODUCTION

As rational, emotional, (may be also temperamental!) and also as active, deliberative individuals we all have our own subjective/objective preferences and choices. We act upon these choices by taking into consideration the urgency and/or priority of our current needs vis a vis other needs pressing at the moment and also vis-a-vis, the availability of resources at our disposal for fulfilling such needs or wants. The study of such choice behavior at an individual level has been long established as a core part of a discipline called as behavioral economics. Behavioral Economics goes about analyzing the choice behavior of a complex, multi-dimensional human individual by abstracting the individual as simply a rational, self-interested agent who will always try to maximize his own utility in making his/her choices at every possible opportunity. This abstraction of a multidimensional complex human individual into a utility maximizing rational agent, no matter however simplified, has enabled the discipline to build a consistent theoretical framework around individual behavior facilitating analysis of individual choices to a limited extent under some restricted circumstances.

When it comes to not a single individual but rather a society or collective of individuals, where although each individual might be again abstracted as a rational utility maximizing agent having his own preferences, however the ultimate choices that needs to be made are collective, then many more questions and considerations become important. Some of the pertinent ones can be articulated as follows: how should a society collectively, deliberatively go about making its choices, by giving due considerations to the preferences or choices of every individual member, so that the ultimate social choices agreed upon collectively is fair to all and representative of everybody's choices and preferences as well as efficient to decide upon? What are the various ways or mechanisms to come up with social choices/preferences from collection of individual choices/preferences? What properties should such mechanisms satisfy to ensure that the ultimate social choices that it has come up with is fair to all and representative of all the individual choices or preferences? If as individuals, we can make rational choices that is beneficial to us individually then can we safely take it for granted that as a society as a whole also we can always make socially rational choices benefiting not one or just a few but most if not all? Is such genuine social choice even possible? If yes, what are its limitations? If no, then are there any consolations or circumventions possible?

Classical Social-Choice theory (particularly in its modern form) is a discipline which provides an elegant mathematical framework to the analysis and design of methods for such collective decision making.

The rest of the paper is organized as follows: Section 2 introduces the reader to the fundamental concepts and methods that together form the main conceptual pillars of the classical social choice theory; section 3 explores various problems of collective choice addressed by social choice theory; section 4 illustrates impossibility theorems and other such paradoxes that emerge in coming up with rational social choice mechanisms; section 5 deals with the constructive program initiated by Amartya Sen and others in overcoming the pessimism inherent

in impossibility results; section 6 introduces the reader to the enriching cross fertilization of ideas between social choice theory and computer science resulting in a new field known by the name of computational social choice; finally, section 7 concludes by summarizing the paper and alluding to the way forward.

## 2. CLASSICAL SOCIAL CHOICE THEORY

Social Choice implies talking about and deciding for society as a whole: the choices of society, made collectively by society, and for society's welfare as a whole (Sen, A., 1999). It involves talking and deciding at aggregate level not individual level. For example, when we might want to talk usefully and rationally about "aggregate poverty" even though at individual level poverty might have too many diverse dimensions, "aggregate judgements" even though there might be variety of individual variations in individual judgement, "aggregate beliefs" or "aggregate preferences" of the society as a whole considering very different and diverse preferences at individual level. What are the reasonable ways to construct such aggregate measures which gives due and fair consideration and representation to individual measures? The aggregate should not only be composed from the individual but also represent in a collectively fair and representative manner the choices which are in a true sense social choices, i.e. choices that can be justified as collectively rational and beneficial for the society as a whole without being unfair or as minimally and evenly unfair to almost all (Sen A, 1999).

There are various scenarios where such social choice problems arise and some procedures for actually computing fair, representative and collectively beneficial social choices are relevant and required. Some of the important and popular social choice scenarios mentioned in the literature are: i) Preference Aggregation ii) Voting iii) Fair Division (Resource Allocation & Negotiation) iv) Judgement Aggregation & v) Belief Merging (Chevalyere, Y., et al. 2007). Each of these social choice scenarios (i.e., social choice problems) will be explained in a little more detail along with its corresponding mathematical framework in the next section.

## 3. PROBLEMS OF SOCIAL CHOICE

### A. Preference Aggregation:

This is the most abstract and general social choice problem, which forms the basic building block to all other specific social choice problems like voting, fair-division, judgement-aggregation etc. This is so, because every other social choice scenario has in some form a requirement for preference aggregation. What is the specific meaning of preferences and how they are aggregated and what evaluative criteria is used to measure the fairness or reasonability of the aggregated social choice might differ? In this most general form of Preference Aggregation every agent's preferences are represented as a complete and strict linear-order (also called as preference order). That is, every agent ranks the candidate alternatives from the most favored to the least favored. These individual preferences of all the (say) 'n' agents (now together called as preference profile of n agents) are aggregated somehow to generate a social preference order.

Thus mathematically speaking preference aggregation is a function that maps every preference profile (from the domain of all possible preference profiles) to a particular social preference order (in the domain of all possible preference orders). To define preference aggregation in a mathematically elegant framework of Social Welfare Functions (SWFs) we need to first specify these general concepts we have seen in mathematically precise form:

Let  $I = \{1, \dots, n\}$  denote the set of at least two or more individuals (sometimes labeled as voters or agents). Let  $A$  denote the set of at least two or more alternatives (also labelled as candidates). Every individual  $i$  "entertains" preferences over alternatives in  $A$ . These individual preferences are usually represented by a transitive and complete ordinal preference relation denoted by  $\succsim_i$ . If  $a \succsim_i b$  and  $b \succsim_i c$ , then transitivity implies that  $a \succsim_i c$ . Whereas, completeness implies that any two alternatives are comparable. That is for any two alternatives  $a$  and  $b$  it holds that either  $a \succsim_i b$  or  $b \succsim_i a$ , or both (Brandt, F., et al. 2012)

Let  $R(A)$  denote the set of all possible preference relations over the alternatives in  $A$ . Thus  $R(A)^n$ , a Cartesian product of  $R(A)$   $n$ -times, would denote the set of all possible preference profiles, each profile being a tuple of  $n$  individual preference relations considering the population of  $n$  individuals. Given this mathematical context, the preference aggregation can now be defined elegantly as a function, named as social welfare function that maps individual preference relations from the set  $R(A)^n$  to a social (or collective) preference relation in the set  $R(A)$ .

Given the above mathematical setting, the mathematical definition of Social Welfare Function (SWF), which is nothing but a mathematical abstraction for preference aggregation, is as defined below (Brandt, F., et al. 2012).

Social Welfare Function: A social welfare function (SWF) is a function  $f: R(A)^n \rightarrow R(A)$

SWFs are useful when one is interested in a "full social preference relation"; that is, given individual preference rankings over all alternatives one is interested in knowing social (or collective) rankings over all alternatives

that are socially rational and beneficial. But some time such full social preferences can give rise to certain paradoxes or there might be no way to arrive at rational and fair social preferences by any preference aggregation over individual preferences. [see section 2.2: Paradoxes and Impossibility Results in Social Choice].

In many cases applications are only interested to find a socially preferred alternative or may be a set of such socially preferred alternatives and not a complete collective ranking. The preference aggregation methods that provide socially preferred alternative(s) from individual preferences can be abstracted mathematically as social choice functions (SCFs). Social Choice Functions (SCFs) maps individual preferences along with a feasible sub-set of alternatives to a socially preferred set of alternatives, such that each one of the socially preferred alternatives will be from the considered feasible subset. Here let  $F(A)$  denote the set of all possible feasible sets, which is in turn defined as the set of all non-empty subsets of  $A$ . The mathematical definition of an SCF can be given as:

Social Choice Functions (SCFs): A Social Choice Function (SCF) is a function

$f: R(A)^n \times F(A) \rightarrow F(A)$ , such that,  $f(R, A) \subseteq A$  for all  $R$  and  $A$ .

### **B. Voting:**

We need some form of preference aggregation for any collective decision making task. But this is not enough, as ultimately there should be some way post preference-aggregation to bring about some concrete collective decision. The mathematical abstraction of preference aggregation with the corresponding elegant frameworks of Social Welfare Functions (SWFs) and Social Choice Functions (SCFs) has no doubt helped to provide Social Choice Theory with a strong mathematical and analytical foundations that aids to understand the possibilities and limitations of Social Choice.

However, ultimately Social Choice can be usefully applied to reality by only such concrete social choice tools like voting, fair-division, judgement aggregation & belief-merging etc. Out of all these concrete social choice mechanisms, voting forms one of the most popular, essential and most studied such tools of collective decision making. In fact, one can say that the field of Social Choice theory was started by the pioneers like Marceus Condorcet and Borda, with the in-depth study and analysis of such voting procedures (or voting rules).

There is an extensive variety of voting rules studied in the social choice literature. It is useful to start with the plurality rule as almost everyone in a democratic country holding parliamentary elections must be familiar with its working. The working of the plurality rule and Borda rule is explained next. Then we are going to see how voting rules can be categorized into certain classes (or families) of voting rules sharing some common properties or workings. In particular, we are going to see two important classes of voting rules, viz:

- a) (Positional) Scoring Rules and
- b) Condorcet Consistent Rules.

For all the subsequent discussions on voting rules the assumption will be that there are  $n$  number of voters (also called agents/individuals) and  $m$  number of candidates (also called alternatives).

- **Plurality Rule and Borda Rule:** In plurality rule every voter gives score of 1 to his most preferred candidate and score of zero to every other candidate in his preference ranking. (i.e., he votes for only his most preferred candidate). Every candidate's final score is computed by summing the scores he gets from all the individual voters. The candidate with the maximum score is declared as the winner by the plurality rule. If there are ties, they are broken by some arbitrary tie-breaking rule.

Borda rule is similar to Plurality in the sense that every voter gives a score to every candidate according to his rank in the preference order. However, in Borda rule instead of score 1, the most preferred candidate is given a score  $m - 1$ , the next preferred candidate gets a score of  $m - 2$ , and so on, so that the second least preferred candidate should get a score as 1 and his least preferred candidate would be given no score (i.e., a score of zero) by every voter.

- **Majority Rule and The Condorcet Winner:** In pairwise majority rule every two pairs of candidates are pitched against each other to compute a winner among them. The candidate who gets more votes in the pair is the winner among the pair. And the candidate who wins the most pairwise elections is the final winner according to the majority rule.

If there is a candidate which defeats every other candidate in pairwise elections, then such a candidate is called as the Condorcet Winner. Choosing a Condorcet Winner is significant according to Social Choice theorists as such Winner is defeating every other candidate and would be unique if there is one. However not all voting rules are capable of electing a Condorcet Winner even if such exists (Brandt, F., et al. 2012).

**Families of Voting Rules:** In fact, many individual voting methods can be considered as part of a single family sharing common features with other voting rules in the family. Below we classify and describe, positional scoring rule, Condorcet consistent voting rules and other remaining rules as voting rule families:

### 1. Positional Scoring Rules

In fact both the Plurality rule and the Borda rule falls under the same family of Positional Scoring Rules. Every voting rule that is a Positional Scoring Rule has a pre-defined scoring vector  $s = (s_1, s_2, \dots, s_m)$ , where  $s_1, s_2, \dots, s_m$  are scores such that  $s_1 > s_2 \geq s_3 \geq \dots \geq s_m$ . A voter gives a score of  $s_i$  to a candidate if he is ranked at position  $i$  in his preference order. Every distinct positional scoring vector would give us a different voting rule under the family of Positional Scoring Rule. For instance, note that the scoring vector of Plurality rule is  $s = (1, 0, 0, \dots, 0)$ , whereas the voters vote under Borda Rule, scores are according the scoring vector  $s^* = (m - 1, m - 2, \dots, 1, 0)$ , where  $m$  denotes the total number of candidates. In addition to Plurality and Borda one additional voting rule in the class of Scoring Rules is the one called as *Anti-Plurality Rule* or also sometimes called as *Veto Rule*. **Veto rule** chooses all those candidates as winners who are Vetoed (least preferred) (given score zero) by minimum number of voters. The scoring vector for Veto rule is thus  $S = (1, 1, 1, \dots, 1, 0)$ .

The significance of Scoring Rules is that these are easy to compute voting rules and thus are widely used and secondly they are the only voting rules that are capable of simultaneously satisfying the properties of reinforcement, anonymity, neutrality (under some additional technical assumption). [Brandt Et al] One limitation of the class of Scoring Rules is that for every scoring rule there is a preference profile for which the rule is not able to choose a Condorcet Winner even if such winner exists. And since Social Choice theorists attach a lot of significance to Condorcet Winners if there is one the inability to select Condorcet Winner sometimes when one exists is considered as a major weakness of Scoring Rules as a class.

### 2. Condorcet Extensions

If a voting rule elects a Condorcet Winner whenever one exists the rule is known as a Condorcet extension. Copeland's rule, Maximin, Dodgson's rule, Young's rule, etc., are voting rules which are Condorcet extensions. Whereas, plurality rule, STV, Borda rule are not Condorcet extensions, because they may not return a Condorcet winner even though it exists.

### 3. Other Rules:

STV and Bucklin's Rule are some of the other rules which do not fit into either of the above two voting rule families.

**Voting Rules and Social Choice Functions (SCFs):** In an abstract form all the voting rules can be seen special case of Social Choice Functions (SCFs) mapping set of all user's/voter's preferences and a feasible subset of alternatives to a sub-set of alternatives collectively chosen from the feasible set. The only special case being that the feasible set in this case is the universal set of all candidates  $C$ . Thus all the mathematical theorems in Social Choice Theory applicable to SCFs would also be directly applicable to all voting rules. (This is the advantage of the mathematical foundations underpinning Social Choice Theory). Nevertheless, because of certain subtle technical distinctions it is better to discriminate between SCFs and voting rules (see Brandt, F., et al. 2012). Therefore, a separate form of mathematical function is used to provide abstraction for a Voting Rule; this function is simply a mapping from the set of all preference profiles ( $\mathcal{R}(C)^n$  is the domain) to the set of all alternatives ( $\mathcal{F}(C)$  is the codomain). The feasible sets are not considered in the domain for the mapping unlike in the SCFs. The definition of Voting Rule as a mathematical function follows:

Voting Rules Functions: A voting rule is a function  $f: \mathcal{R}(C^n) \rightarrow \mathcal{F}(C)$ .

Fair division, resource allocation, judgement aggregation, belief merging, coalition formation etc., are some of the other concrete social choice problems amenable to similar formal analysis & design made possible by the classical axiomatic social choice framework.

### 4. Impossibilities and Paradoxes in Social Choice

Since 18th century when Borda and Condorcet the pioneers of social choice theory were starting to establish it as a separate discipline of study, they were motivated by the practical goal of constructing a

systematic, workable and predictable basis for making social choices; social choices that were rational, democratic and at the same time representative of divergent individual interests. However even at the theory level they soon became aware about certain paradoxes inherent in making rational, democratic, and representative social choices. [Amartya Sen, Nobel Lecture]

For instance, Condorcet one of the founding fathers of Social Choice theory had pointed to a paradox where he had shown that aggregating individual preferences by majority rule into social preference ordering might sometimes lead to cycles in the social rankings. Thus for certain preference profile it might happen that alternative a is preferred over alternative b by a majority of voters, alternative b is preferred over alternative c again by a majority of voters, and then alternative c is preferred over alternative a also again by a majority leading to a cycle. So there is no rational social ranking of preferences possible in such a scenario. This paradox is popular in the social choice literature as **Condorcet Paradox**.

With the publishing of the seminal Ph.D thesis of Kenneth Arrow in mid 20th century and particularly due to his seminal impossibility theorem in that monograph the initial tentative negativity about the possibility of rational social choice turned into almost a general cemented gloom about its very certain unworkability. [1951, Arrow] In its very essence what the Arrowian Impossibility Theorem (He had named it as 'A General Possibility Theorem') proves is that the only possible reasonable social welfare function is none other than dictatorship'. The reasonability of a SWF is judged by Arrow on the basis of the SWF satisfying the three basic axioms of reasonableness namely IIA, Pareto-Optimality and Non-Dictatorship.

The three axioms in Arrowian Impossibility can be explained thus: **IIA (Independence of Irrelevant Alternatives)** essentially means that the social preferences between any alternatives should depend only upon their relative order in the individual preferences and should be independent of how other alternatives are ranked in the individual preferences; **Pareto-Optimality** requires that if all the individuals unanimously prefer alternative a over alternative b then the social ranking should also rank alternative a above alternative b; **Non-dictatorship** implies that there should be no individual (a dictator) whose preference order is always getting reflected in the social order no matter what the other individual preferences are in the preference profile. All these three axioms seem very mild conditions of reasonableness indeed; therefore, because Arrow's Impossibility Theorem essentially proves that there is no SWF which can satisfy even such mild basic conditions of reasonableness, hence the resulting gloom about the general unworkability of social choice. Arrow's Impossibility Theorem can be articulated mathematically, in terms of Social Welfare Functions, as under:

**Arrow's Impossibility Theorem:** (Arrow 1951) There exists no SWF that simultaneously satisfies IIA, Pareto-optimality, and non-dictatorship whenever  $|U| \geq 3$ .

In addition to Arrowian Impossibility the other seminal impossibility result in the social choice literature is termed as Gibbard-Satterthwaite Impossibility Theorem [ref]. This theorem proves that every reasonable voting rule is vulnerable to strategic manipulation. Mathematically it is articulated in the following way:

**The Gibbard-Satterthwaite Impossibility:** Every non-imposing, strategy-proof, resolute voting rule is dictatorial when  $|U| \geq 3$ . (U denotes the finite set of all alternatives)

There are a variety of other impossibility results that numerous other researchers have come up with. (Brandt, F., et al. 2012) gives a good survey of many other impossibility results pervading the classical social choice theory.

##### 5. Tackling Social Choice Impossibilities - Attempts at "Constructive Pessimism"!

Amartya Sen, in his Nobel Lecture (Sen, A., 1999), points to pervasive gloom created by Arrow's impossibility results. He however takes & underscores a need to take a constructive view of Arrow's work. According to Sen, although Arrow's work did uncover the theoretical impossibility of devising social choice procedures that satisfy even certain basic reasonable properties, nevertheless for the first time the field was put on a solid mathematical foundation. To put it in Sen's own words: "[Arrow's] diagnosis of a deep vulnerability in the subject overshadowed [his] immensely important *constructive* program of developing a systematic social choice theory that could actually work"

Amartya Sen and others launched a program of "Constructive Pessimism" where by many scenarios were characterized in which expected majority decisions are indeed possible.

## 6. Computational Social Choice - An Interplay between CS/AI and Social Choice

Computational Social Choice is not just an amalgamation of computer science and social choice disciplines. It is far richer than that. Other allied disciplines or sub-disciplines of computer science & economics that includes: game theory, operations research, artificial intelligence, machine learning, social network analysis, multi-agent systems, mechanism design etc., are also part of the mix. However, we won't go into the specifics of the individual contributions made by these disciplines to social choice and vice versa. We will focus on broad-stroke interplay between computer science and social choice. For getting acquainted with the richer tapestry that computational social choice truly is, you may refer to [Xia, L., 2013; Aziz, H., et al. 2019; Procaccia, A.D., 2015; Shoham, Y., 2008; Brandt, F., et al. 2012].

Below we describe the interrelationship that has emerged between social choice theory and computer science by highlighting the role they play and the contributions they have made to each other.

### A. Social Choice Theories' Contributions to Computer Science

Around the last decade of 20<sup>th</sup> century, i.e., in the 1990s the relevance of social choice theory to computer science and applications domain became apparent. In particular, if a software system can be thought of as consisting of a society of autonomous software agents, each with their own individual objectives, capabilities, and each having partial information about the system, then in order to arrive at a collective decision or achieve a system level goal, the analytical framework of social choice theory becomes relevant. Even certain computer science applications/problems like Internet Search and Recommendation Engines can be looked or reformulated as social choice problems, allowing insights helpful in design and implementation of corresponding solutions.

- 1. Internet Search as a Social Choice Problem:** Internet search, based on webpage ranking, particularly Google's page rank algorithm can be thought of as a voting procedure where the voters also double up as candidates. Both come from the population of web-pages that are to be ranked. A web-page cited most by other web-pages come up in the ranking. Other related problem, that of meta search, where the web-page ranking of different search engines are aggregated into a consolidated ranking, is nothing but a sort of preference aggregation. The axiomatic framework of classical social choice theory can aid the analysis and design of such Internet Search problems.
- 2. Recommendation Engines as Social Choice Computers:** Recommendation engines recommend products to customers depending upon the past buying profile of the customer as well as product preferences of other customers. This approach, commonly known as collaborative filtering can be cast as Social Choice procedures. Thus, the theoretical framework of axiomatic social choice theory can be a useful aid in designing recommendation algorithms.
- 3. Collective Decision Making & Resource Allocation in Multi-Agent Systems:** Multi-Agent Systems are nothing but a society of autonomous software agents. Thus, the analytical framework of social choice theory is directly applicable to the collective decision making & resource allocation needed in such Multi-Agent Systems.

### B. Computer Science's Contributions to Social Choice Theory.

Computer Science has contributed to Social Choice Theory mainly by providing it with algorithmic analysis of various preference aggregation and other social choice procedures. An important result to take note of is about the computational hardness of strategic manipulation in Dodgson's Voting rule. So although the Gibbard-Satterthwaite Impossibility, a mathematical result from social choice theory that we described above tells us that every non-dictatorial voting rule is vulnerable to strategic manipulation, computer science tells us that sometimes it can be computationally hard. Such algorithmic analysis, particularly the tools of complexity theory from computer science is helping social choice theorists in designing social choice procedures which although are mathematically vulnerable to undesirable properties, computationally the actual emergence of these properties will be infeasible.

## 7. CONCLUSION

Social choice theory originated in political science and economics as an area of study dealing with systematically and rationally aggregating individual preferences into socially preferences, such that it reflects the individual preferences in a fair and rational manner. Although social choice problems, in the form of voting rules are studied since ancient times, the birth of its modern axiomatic mathematical form took place in 1950's with Kenneth Arrow's seminal PhD thesis. Although Arrow described a rather gloomy Impossibility Theorem in that thesis, pinpointing in a formally sound manner the impossibility of any voting procedure that satisfies



even simple desirable properties, further work by Amartya Sen and others built upon his work proving certain optimistic results under relaxation of certain constraints.

This paper introduced the axiomatic mathematical framework of social choice theory, the main mathematical results that included Arrow's seminal Impossibility Theorem and another Gibbard-Satterthwaite Impossibility result. It also briefly explained various voting rules along with the concept of Condorcet Winner.

Lastly the paper introduced Computational Social Choice as an interplay between Computer Science and Social Choice. The relevance of Social Choice theory to Computing Systems and Applications and contrariwise the contributions of Computer Science methods to Social Choice problems was highlighted.

## REFERENCES

1. Aziz, H., Brandt, F., Elkind, E. and Skowron, P., 2019. Computational social choice: The first ten years and beyond. In *Computing and software science* (pp. 48-65). Springer, Cham.
2. Brandt, F., Conitzer, V. and Endriss, U., 2012. Computational social choice. *Multiagent systems*, 2, pp.213-284.
3. Chevaleyre, Y., Endriss, U., Lang, J. and Maudet, N., 2007, January. A short introduction to computational social choice. In *International Conference on Current Trends in Theory and Practice of Computer Science* (pp. 51-69). Springer, Berlin, Heidelberg.
4. Obraztsova, S., Markakis, E., Polukarov, M., Rabinovich, Z. and Jennings, N., 2015, February. On the convergence of iterative voting: how restrictive should restricted dynamics be?. In *Proceedings of the AAAI conference on artificial intelligence* (Vol. 29, No. 1).
5. Procaccia, A.D., Zohar, A., Peleg, Y. and Rosenschein, J.S., 2009. The learnability of voting rules. *Artificial Intelligence*, 173(12-13), pp.1133-1149.
6. Procaccia, A.D., 2015. How is voting theory really useful in multiagent systems. available online, URL: <http://www.cs.cmu.edu/arielpro/papers/vote4mas.pdf> (DOA: 15.01. 2013).
7. Sen, A., 1999. The possibility of social choice. *American economic review*, 89(3), pp.349-378.
8. Shoham, Y., 2008. Computer science and game theory. *Communications of the ACM*, 51(8), pp.74-79.
9. Xia, L., 2013, May. Designing social choice mechanisms using machine learning. In *Proceedings of the 2013 international conference on Autonomous agents and multi-agent systems* (pp. 471-474).

## Generalized Implementation of Virtual Reality on Non-Immersive Display System with Head Tracking

Shubhangi Pasalkar

MKSSS's KB Joshi Institute of Information Technology, Pune, India

### ABSTRACT

After complete improvement in three-D era, content material on screen and projector wants to be enhance thinking about the digital truth and want of three-D era to simulate a couple of modelling. A Virtual Reality System approach should be evolved for digital area alignment in VR aided show structures. Correspondence among Display and three-D version is primarily based totally at the dimensional attributes and the geometric relationships among them. An easy Head Tracking System can shape Virtual Reality System on Non-Immersive Approach.

Indexterm: Virtual Reality (VR), Relative VR, Virtual Window VR, Fish tank VR

### 1. INTRODUCTION

The medical visualization network wants to makes use of digital truth show structures that simplify new visualization and interplay techniques. Determining the Advantages of various VR show structures for exceptional packages and obligations is accordingly crucial for growing powerful visualization equipment in addition to new displays. Further Virtual Reality System Can be categorized as below

Non-immersive (desktop) systems: Non-immersive structures, as the connection suggests, are the least immersive application of VR technologies. Using a laptop computer, digital environments (VEs) are viewed through a portal or window with the help of a modern, high-resolution display.

Semi-Immersive Projection Systems: Semi-immersive structures are a rather new implementation of VR era and borrow appreciably from technology evolved withinside the flight simulation field. A semi-immersive device will include a rather excessive overall performance portraits computing device which may be coupled with both a massive display screen projector device, a couple of tv projection structures. Fully Immersive Head-Mounted Display Systems: All completely immersive structures will provide an experience of presence that can't be equalled with the aid of using the alternative techniques discussed earlier, however the experience of immersion relies upon on numerous parameters such as the sector of view of the HMD, the decision, the replace rate, and comparison and illumination of the show.

Though completely immersive and Semi Immersive Display offer excessive practicality nevertheless a chunk impractical in Real international software.

In Non-Immersive show using polarized mild manipulated show do now no longer provide real impact of three-D. So, some other manner to enforce digital truth on Non-Immersive show is enforce digital truth device. Most Sophisticated method use with the aid of using digital truth device developer is to apply head monitoring with the aid of using Real- time infrared sensor or video enter device. In video video games and digital environments (VEs), visible views are commonly to be had to the users: A first- individual perspective (1PP) additionally referred to as first individual shooter wherein the digital digicam is withinside the role of the avatar's eye referred to as Point of View and a third-individual perspective (3PP) [4] wherein the digital digicam follows the avatar with an adjustable distance and attitude of view more often than not use in Car Racing Games. The utilization of 3PP has turn out to be a subject of hobby due to its technological effect withinside the society, e.g., greater therapists and clinical professionals are the use of digital truth for rehabilitation. [4]

This additionally extends to artists like Marc Owens who appears to were stimulated with the aid of using our first 3PP prototype. [1]

### 2. PREVIOUS WORK

It is tough to categorize all VR structures, this paper separates them primarily based totally on their implementation on non-immersive show era:

Projection-primarily based totally VR structures (CAVE VR) (e.g., CAVE [Cruz-Neira et al. 1993] or workbench [Kreuger et al. 1995]) [2].

Window VR (E.g., Image motion VR Second implementation)

Fully portable and screen-based virtual reality structures (e.g., virtual reality in aquarium [Weir et al. 1993]). Visualization researchers are increasingly using virtual reality interfaces to build packages for field scientists to view 3D medical records using a variety of visualization techniques [Hansen and Johnson [2004]. However, there are currently few indications about what type of projector to use, in particular, based entirely on evidence from both qualitative and quantitative analysis. This can cause optimization of packages whose design will not use the simplest device to address the problem of the world of the region.

#### **CAVE VR [Cave automatic Virtual Environment]**

Cruz-Neira proposed the device of setting the display screen across the person and projecting person photograph synchronising show growing the view. System is flawlessly relevant for designing a flight and riding simulator [4].

But for regular use the device nevertheless impractical. However research have as compared exceptional VR device and conference monoscopic show, this device have greater studies than any digital truth device. Also this device is applied on Airbus simulator to F1 simulator for training.

#### **Window VR**

Window Virtual truth his applied with the aid of using sure set of screen. Instead of imposing direct window makes use of mouse API to enforce visible notion for digital truth. Using a few fashionable the consequences of an empirical study, Many Developer evolved such hints for the selection of show surroundings for especially for laptop device.

And the time of imposing the device with head monitoring theories window vr the complete extent of display screen vicinity been decided on and create the visible notion of window. It makes use of mouse API to carry out opposite operation at the show vicinity in step with the person head. [3]

#### **Fish tank VR**

In fish tank, all of the visible notion is just like window VR however intensity of the display screen is restricted with the aid of using simple parallel to the display screen edge. The digital truth may be applied in that element with the aid of using setting item among 4 plains [fig. 2]

Difference among the CAVE, Fish tank and Window Virtual Reality

Each of the three-D version applied withinside the portraits have person specific function defining their very own residences in fig three (a) simply easy item on with none heritage however if we examine version with different 3 it offers greater visible notion.

If fig. three is area on 3 separate display screens with setting item at the center display screen with out head monitoring it provide three-dimensional visible notion of item in centre of display screen.

Fig3 (c) offers instance of window VR in which intensity of the display screen measurement is undefined.

Where fig three (d) is greater of Fish tank Virtual Reality in which intensity measurement is restricted with the aid of using the white cord frame. [3]

Head Tracking relies upon on Perceptual Computing digital digicam is designed to be installed on pinnacle of the screen. Design your software assuming that that is the area of the digital digicam.

The digital digicam is generally pointed on the consumer such that the consumer's head and the higher part of the consumer's torso are in view. For a huge table hooked up display, the digital digicam top might be in spite of the pinnacle of the consumer's head, orientated to appearance down on the consumer. For a software ought to assist those exceptional digital digicam configurations to enforce Head Tracking. [3]

There are many viable answers to be had to enforce Head monitoring with everyday digital digicam together with Free Track, TrackIR, FreeTrackNoIR etc.

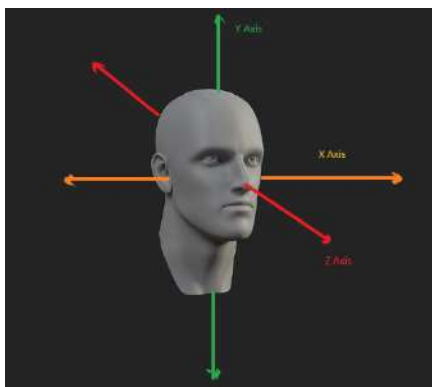
### **3. PROPOSED SYSTEM**

Proposed system is based on the window VR using non-immersive display

Defining X axis along passing through both ears

Defining Y axis along passing through Neck and Top of the head

Defining Z axis along passing through Nose and Back of the head



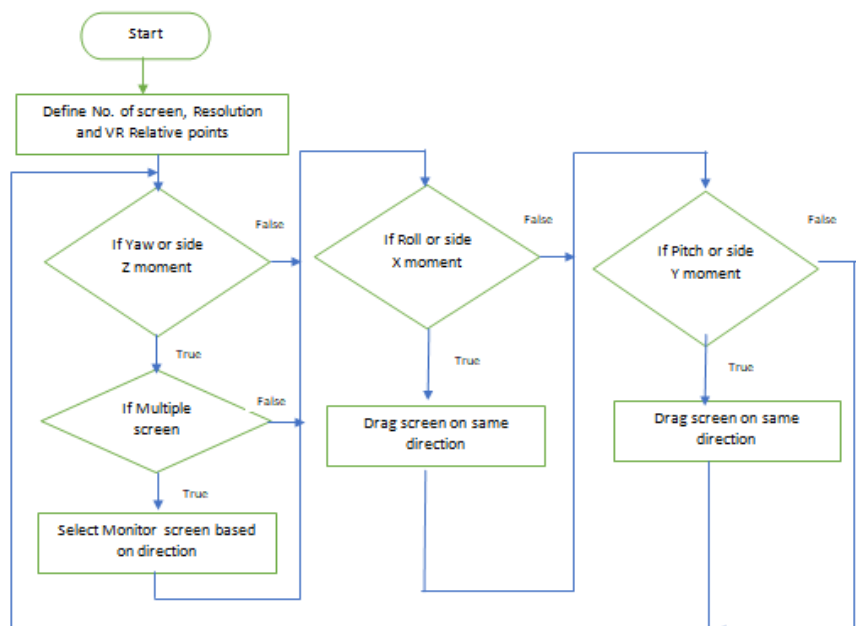
Pitch moment will be defined as rotational moment along X axis

Yaw moment will be defined as rotational moment along Y axis

Roll moment will be defined as rotational moment along Z axis

User can follow development of following flow chart

It's a continuous recursive system and has no end point. It requires manual user intervention to put it in halt.



#### 4. CONCLUSION

This paper has provided a digital digicam primarily based totally approach and Wii mote primarily based totally for interacting withinside the digital environments. The Algorithm is primarily based totally on deciding on and monitoring distinguished nook capabilities from the surroundings (without predefining them), and generates relative orientation and zooming parameters. The consumer takes a look at has found out that in spite of the approximate relative movement monitoring, it exhibited as a minimum promising (thinking about the fantastically low quantity of topics) overall performance advantage and desire over the same old button primarily based totally interface.

This affiliation is in particular powerful due to the fantastically small visible display. There are many feasible programs of together with surfing and interacting in fantastically huge digital environments (e.g. game) or with such digital items (e.g. lengthy hierarchical menus or huge documents). [4] Our device works fairly properly in static surroundings, however because of the character of the characteristic choice set of rules, now no longer so properly in very dynamic (speedy moving) or plain (no nook capabilities) environments (e.g. in vehicle with the digital digicam confronted outside). And the zooming component is handiest an approximate to that of the actual international scale. We are persevering with to enhance the set of rules and would love to analyse how the inexact in shape among the quantities of motion among the actual and digital international influences the consumer overall performance and presence.

This paper additionally lacks enough quantity of topics and we're presently including extra difficulty data.

## 5. FUTURE WORK

The mapping withinside the set of rules is geometric consist described rules thinking about the surroundings and item and outside surrounding. Implementing real truth with VR device require perception like first individual or individual belief and the way it connect to applied set of rules.

It is vital assignment to create getting to know mapping which in addition define the significance of Computer in addition to human imaginative and prescient to interact with every different.

It is likewise query of getting to know and version improvement strategies which in addition may be evolved thinking about this layout with a sure platform to layout and broaden this method for enforcing real belief of human consumer to collaborate a particular software. Algorithm makes use of the API which encompass Mouse appearance characteristic mainly use in first individual shooter video games which have to evolved at consumer facet thinking about the globalized answer for set of rules.

Considering the primary drawback of monitoring handiest one head or individual, set of rules Perform invalid operation if different individual comes into focus.

## 6. REFERENCES

- [1] ARTHUR, K.W., BOOTH, K. S., AND WARE, C. 1993. Evaluating 3D task performance for fish tank virtual worlds. *ACM Trans. Inf. System* 11, 3, 239–265.
- [2] F. Hemmert, D. Djokic, and R. Wettach, "Perspective Change: A System for Switching between On- Screen Views by Closing One Eye," *Proc. Working Conf. Advanced Visual Interfaces (AVI '08)*, pp. 484-485, 2008
- [3] C. a\_gatay Demiralp, Cullen D. Jackson, Member, IEEE, David B. Karelitz, Song Zhang, and David H. Laidlaw, "CAVE and Fish tank Virtual-Reality Displays: A Qualitative and Quantitative Comparison" pp 1077-2626/06 ISSN 173 volume 19 2011
- [4] Patrick Salamin, Tej Tadi, Olaf Blanke, Frédéric Vexo, and Daniel Thalmann "Quantifying Effects of Exposure to the Third and First- Person Perspectives in Virtual- Reality Axis-Based Training" 1939-1382/10 volume 1 2010
- [5] H. Yang and G.M. Olson, "Exploring Collaborative Navigation: The Effect of Perspectives on Group Performance," *Proc. Fourth Int'l Conf. Collaborative Virtual Environments (CVE '02)*, pp. 135- 142, 2010-11.
- [6] D. Tougaw and J. Will., "Visualizing the future of virtual reality," *Computing in Science and Engineering*, vol. 05, no. 4, pp. 8–11, 2003.
- [7] S. Su, W. Sherman, F. C. H. Jr., and M. Dye, "Taverns: Visualization and manipulation of gis data in 3d large screen immersive environments," in *ICAT Workshops*, 2006, pp. 656–661.
- [8] M. Katzourin, D. Ignatoff, L. Quirk, J. J. L. Jr., and O. C. Jenkins, "Swordplay: Innovating game development through vr," *IEEE Comput. Graph. Appl.*, vol. 26, no. 6, pp. 15–19, 2006.

## **NLP: Institute Review Feedback Using Sentiment Analysis**

**Sulakshana Vispute<sup>1</sup>, Abhiraj Ghadge<sup>2</sup> and Rahul Mithbavkar<sup>3</sup>**

<sup>1</sup>MCA Department, NMITD, Mumbai University, India

<sup>2,3</sup>DES Navinchandra Mehta Institute of Technology and Development, Dadar, Mumbai, India

### **ABSTRACT**

Sentiment Analysis is a subset of Natural Language Processing (NLP), a subject of Computer Science more particularly, Artificial Intelligence concerned with teaching machines/computers to understand text and spoken words in the same manner that humans can. Computational linguistics which is rule-based human language modeling with statistical, machine learning, and deep learning techniques in NLP. When these technologies combine, a great technology gets introduced which allows computers to process human language which can be in the form of text or speech data and interpret the full meaning, including the speakers or writer's intent and sentiment.

Keywords: computational linguistics, machine learning, analysis, sentiment, NLP, Deep Learning.

### **I. INTRODUCTION**

The ability of computer software to understand the spoken and written human language, often known as natural language is called as Natural language processing. It's a part of artificial intelligence.

NLP is into linguistic more than 50 years some applications are medical research, search engines, and corporate intelligence.

### **II. Importance of Natural language processing**

In the fast-growing world huge amount of data is generated in every fraction of seconds. This data is in structured as well as in unstructured format. This data can be used in decision making. Most of the businesses are not able to process this data. Here the need for Natural Language Processing arises.

When evaluating the following two sentences NLP shows its value: "Cloud computing insurance should be included in every service-level agreement," and "A good SLA provides a better night's sleep even in the cloud." If a user searches using NLP the software will consider cloud computing as a distinct entity, cloud as an abbreviated form of cloud computing, where SLA as an acronym for service-level agreement in the business. These are the kinds of ambiguous features that regularly arise in human language and which machine learning algorithms have struggled to interpret in the past. Algorithms can now successfully comprehend them thanks to advancements in deep learning and machine learning technologies. These enhancements increase the amount and variety of data that can be studied.

### **III. Working of Natural Language Processing**

Using NLP computers can understand natural language in the same way that people do. AI uses NLP to capture and understand the input from real world and then process it and then convert it into valid format which can be understood by computer. Just like human have a variety of sense, computers have a software to do the same. Computer have intelligent programs and microphones to collect and process various inputs. Data preprocessing and algorithm development are the two main stages of Natural Language Processing (NLP).

**A) Data pre-processing** Preliminary data processing involves processing and cleaning text data so that machine can process it. Below are the methods to steps for data processing:

- 1) Tokenization. It is the process of splitting a sentence into chunks or tokens.
- 2) Stop removing words. Stop words are the words which are present in the sentence but doesn't contribute value to the natural language processing algorithms. These words are removed from the sentence using predefined libraries.
- 3) Stemming and lemmatization. These are used to obtain the root meaning of the word where stemming cuts down letters and lemmatization derives root word using dictionary.
- 4) Part-of-speech tagging to understand the meaning of sentence it is necessary to labelize the words based on part of speech nouns, verbs, and adjectives.

B) An algorithm is used to process the data once it has been pre-processed. There are a plenty of natural language processing methods are available, however below are the two most widely used:

a) System based on rules. This system employs language rules that have been carefully crafted. This method was employed in the early stages of natural language processing and is still used today.

**b) A system based on machine learning.**

Various statistical approaches are used in ML algorithms. This system processes the given data and get trained based on the data. The more the data is processed the system gets trained accurately on given dataset. NLP based system develop its own rules and improves it through repeated analysis .

**IV. Techniques of natural language processing**

Syntax and semantic analysis are the two primary strategies used in natural language processing.

Syntax is the way of organizing words in a phrase so that they make grammatical sense. Using syntax and grammatical rules, NLP examines the meaning of a language. The following are examples of syntax techniques

**Parsing:** Parsing is the process of analyzing the grammar of a sentence. As an example, the text "The dog barked" is sent to NLP based system. The process of breaking down a sentence into its basic parts of speech, such as dog is noun and barked is categorized into verb, is known as parsing. This is advantageous for operations that necessitate more sophisticated downstream processing.

**Word Segmentation:** The process of extracting word forms from a string of text is known as derivation. For example, a user scans a written document into a computer. The application would have been able to scan the page for white spaces between the text and detect them. All lines relating to the author and association should be highlighted.

**Sentence Breaking:** This generates sentence borders in long texts. For example, the text is given into a natural language system "A bark came from the dog. I became more conscious of my surroundings." The application can predict how long a period is used to break up sentences when sentence breaking is utilized.

**Morphological segmentation:** This breaks words down into morphemes, which are smaller units. The word untestably, can be broken down into [[un[[test]able]] ly, with the morphemes "un," "test," "able," and "ly" recognized by the algorithm. In speech recognition and machine translation, this is critical.

**Stemming:** This divides words into its root forms. For e.g. in the line "The dog barked," the algorithm would have been able to detect that the root word "barked" is "bark." Stemming is useful if a user was seeking for all instances of the phrase bark, as well as all of its conjugations. Despite the differences in letters, the algorithm recognizes that they are essentially the same phrase.

**Semantics** is the study of the meanings of words and how they are used. In NLP, algorithms are used to learn the meaning and structure of sentences. Techniques used in semantics include:

**1) Word sense disambiguation**

This methodology employs context to derive the meaning of a word. Example: consider a phrase "The pig is in the pen." The term "pen" has a variety of meanings. This approach allows an algorithm to figure out that the term "pen" refers to a region rather than a writing pen.

**2) Named entity recognition:**

This determines which words can be combined. Using the semantics of the text, it would be able to discern between visually similar items. For example, the system might recognize the two "McDonald's" in the sentence "Daniel McDonald's son went to McDonald's and ordered a Happy Meal" as two distinct things — one a restaurant and the other a person.

**3) Natural language generation:**

A dictionary/database is used to determine the semantics of words, and new text is generated. For example, an algorithm may automatically write a summary of findings from a business intelligence platform. Another example is automatically making news items or tweets from a corpus of content used for training.

**V. LITERATURE REVIEW**

16,000 tweets were rated as racist, sexist, or neither by researchers. According to the findings, some of the deep learning algorithms are more effective than conventional “n-gram” methods in detecting hate speech.[1]

There are two main ways to obtain a lexicon: creation (often using crowdsourced annotators) or derivation from a preexisting annotated corpus. To improve lexicon the researchers test whether simple techniques like document filtering, frequency cut-off, and text pre-processing were used [2]

The researchers collected a total of 6,800 tweets in their dataset. The tweets were then labelled based on sentiment by nine annotators using a five-point scale. This data includes the demographic groups of those who posted the tweets (gender, age, education, income, religious background, and political ideology). This dataset includes not only Twitter posts, but also detailed information about each poster. Furthermore, this is one of the first studies to investigate how modelling vulgar words can improve sentiment analysis performance. [3]

The Joef Stefan Institute's researchers analysed a huge dataset of sentiment-annotated tweets which is in multiple languages. Multiple automatic sentiment classification models were created by team using these annotated tweets as training data. Their experiments gives fascinating results, including the fact that there is no statistically significant difference is observed between the performance of the top classification models and the overall accuracy of the others.[4]

**Dynabench:** Multimodal Emotion Lines Dataset (MELD) contains 13,000 voice messages from 1,433 dialogues from the hit television show "Friends". Each voice messages has been labelled with emotion with its sentiment. The researchers derived a model for sentiment recognition in dialogues between two or more than two speakers using this dataset. [5]

Attention is a popular mechanism in neural architectures and has been realised in a variety of formats. However, due to the rapid advancements in this field, a systematic overview of attention is still lacking. This paper defines a unified model for attention architectures in NLP, with a focus on those designed to work with textual vector representations. [6]

## VI. RESEARCH DESIGN

In this project, Reseachr timplment a College Review sentiment analysis model that helps to overcome the challenges of identifying the sentiments of the College Review. The dataset provided is the Sentiment Analysis Dataset which consists of 27480 statements and their sentiment in positive negative and neutral category.

### MODEL BUILDING

The various steps involved in Model Building are:

- Import Dependencies
- Read and Load the Dataset
- Exploratory Data Analysis
- Data Preprocessing
- Splitting our data into Train and Test Subset
- Model Building
- Function for Model Evaluation
- Prediction

#### Step-1: Import Dependencies

```
from tensorflow.keras.models import Sequential
from tensorflow.keras import layers
from tensorflow.keras.optimizers import RMSprop
from tensorflow.keras.preprocessing.text import Tokenizer
from tensorflow.keras.preprocessing.sequence import pad_sequences
from tensorflow.keras import regularizers
from tensorflow.keras import backend as K
from tensorflow.keras.callbacks import ModelCheckpoint
```

#### Step-2: Read and Load the Dataset

```
train = pd.read_csv(r'D:\MCA\Project\Dataset\Twitter\train.csv')
```



### Step-3: Exploratory Data Analysis

```
train.groupby('sentiment').nunique()
```

	textID	text	selected_text
sentiment			
negative	7781	7781	5861
neutral	11118	11117	11111
positive	8582	8582	5537

Following that, the punctuations were cleaned and removed, reducing the dataset's unnecessary noise. So after that, we removed the repeating characters from the words, as well as the URLs, since they are of no impact.

### Step 4: Data Preprocessing

```
#Removing URLs with a regular expression
url_pattern = re.compile(r'https?://\S+|www\.\S+')
data = url_pattern.sub(r'', data)

# Remove Emails
data = re.sub('\S+@\S+\s?', '', data)

# Remove new line characters
data = re.sub('\s+', ' ', data)

# Remove distracting single quotes
data = re.sub("'", "", data)

return data
```

### Step-5: Splitting our data into Train and Test Subset

```
#Splitting the data
X_train, X_test, y_train, y_test = train_test_split(tweets, labels, random_state=0)
print (len(X_train), len(X_test), len(y_train), len(y_test))
```

20610 6871 20610 6871

### Step-6: Model Building

```
model = Sequential()
model.add(layers.Embedding(max_words, 20))
model.add(layers.LSTM(15, dropout=0.5))
model.add(layers.Dense(3, activation='softmax'))

model.compile(optimizer='rmsprop', loss='categorical_crossentropy', metrics=['accuracy'])
#Implementing model checkpoints to save the best metric and do not lose it on training.
checkpoint1 = ModelCheckpoint('best_model1.h5', monitor='val_accuracy', verbose=1, save_best_only=True, mode='auto')
history = model.fit(X_train, y_train, epochs=2, validation_data=(X_test, y_test), callbacks=[checkpoint1])
t1 = time.time()
```

### Step-7: Model Evaluation

```
test_loss, test_acc = model.evaluate(X_test, y_test, verbose=2)
print('Model accuracy: ', test_acc)
```

215/215 - 4s - loss: 0.5467 - accuracy: 0.7770 - 4s/epoch - 19ms/step  
Model accuracy: 0.7770339250564575

### Step-8: Prediction

```
sequence = tokenizer.texts_to_sequences(['i like the teaching style'])
test = pad_sequences(sequence, maxlen=max_len)
sentiment[np.argmax(model.predict(test), decimals=0).argmax(axis=1)[0]]
```

'Positive'

```
sequence = tokenizer.texts_to_sequences(['i hate this teacher, they are annoying'])
test = pad_sequences(sequence, maxlen=max_len)
sentiment[np.argmax(model.predict(test), decimals=0).argmax(axis=1)[0]]
```

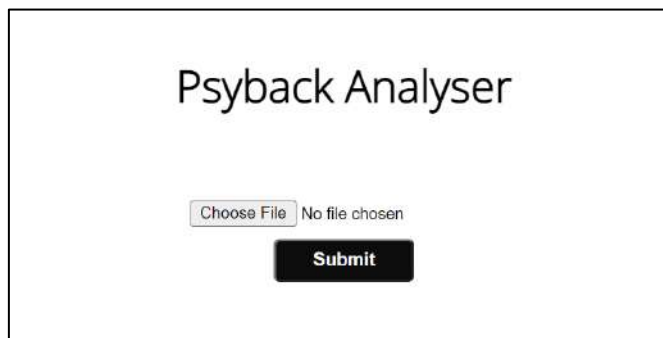
'Negative'

```
sequence = tokenizer.texts_to_sequences(['Cant say anything'])
test = pad_sequences(sequence, maxlen=max_len)
sentiment[np.argmax(model.predict(test), decimals=0).argmax(axis=1)[0]]
```

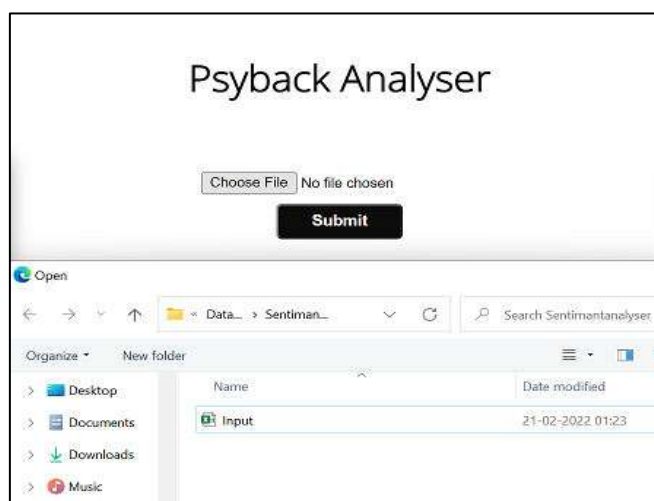
'Neutral'

### VII.Implementation

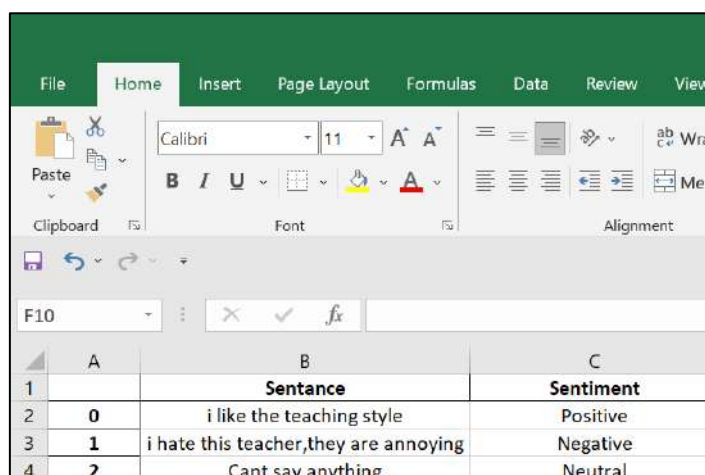
The UI is developed using flask where user has provision to give input via excel file.



User can select particular file which contains the data



After that user submit the file and our analyzer will give output which contains sentiment of the statements provided in input file



The screenshot shows an Excel spreadsheet with the following data:

	A	B	C
1		Sentance	Sentiment
2	0	i like the teaching style	Positive
3	1	i hate this teacher,they are annoying	Negative
4	2	Cant say anything	Neutral

---

### VIII. CONCLUSION

Our Project is Classifying the Student Review into Three Class 1. Positive 2. Negative and 3. Neutral.

We can conclude the following details after evaluating all of the Models:

Accuracy: In terms of model accuracy, the LSTM outperforms the SVM. As a result, we conclude that the LSTM is the best model for the aforementioned dataset.

### IX. REFERENCES

- [1] “Deep Learning for Hate Speech Detection in Tweets” Pinkesh Badjatiya (IIIT-H) , Shashank Gupta (IIIT-H), Manish Gupta (Microsoft), Vasudeva Varma (IIIT-H)
- [2] “DepecheMood++: a Bilingual Emotion Lexicon” Oscar Araque (Polytechnic University of Madrid) , Lorenzo Gatti (University of Twente) , Marco Guerini (AdeptMind Scholar, Bruno Kessler Institute), Jacopo Staiano (Recital AI)
- [3] “Expressively Vulgar: The Socio-dynamics of Vulgarities” From the University of Texas at Austin, Isabela Cachola, Eric Holgate, and Junyi Jessy Li. From the University of Pennsylvania, Daniel Preotiuc-Pietro
- [4] “Multilingual Twitter Sentiment Classification: The Role of Human Annotators” – Igor Mozetič, Miha Grčar, and Jasmina Smailović, from the Department of Knowledge Technologies at the Jožef Stefan Institute
- [5] “MELD: A Multimodal Multi-Party Dataset for Emotion Recognition” Soujanya Poria (SUTD) , Devamanyu Hazarika (National University of Singapore), Navonil Majumder (National Polytechnic Institute of Mexico) , Gautam Naik (Nanyang Technological University) , Erik Cambria (Nanyang Technological University) , Rada Mihalcea (University of Michigan)
- [6] “ <https://analyticsindiamag.com/10-must-read-technical-papers-on-nlp-for-2020/>”
- [7] “<https://github.com/mhagiwara/100-nlp-papers>”

## Threats and Defense for Social Networking in Current Era – An Eye Opener

Sulakshana Vispute<sup>1</sup>, Mokshada Mahesh Potdar<sup>2</sup> and Shubhangi Potdar<sup>3</sup>

<sup>1</sup>MCA Department, NMITD, Mumbai University, India

<sup>2,3</sup>MCA Department, IBMRD, Ahmednagar, SPPU, Pune, India

### ABSTRACT

Nowadays, social media sites are becoming increasingly popular among teenagers and young people, but they also create major security threats, so all users should exercise caution. Social networking sites are becoming more prevalent in our daily lives. For some, it has become as natural as breathing.

Because they are based on the concept of traditional social networks, where users can interact with new individuals through people they already know, social websites are sometimes known as "friend-of-a-friend" networks. The objective of a few social sites may be purely social, ie. Such sites are more focused on establishing users' social relationships while others may concentrate on enterprise connections. Millions of people throughout the world use their mobile phones, apps, and online sites to access social media sites. According to statistics given by the renowned networking social site, Facebook has approximately 2800 million active users, Whatsapp has 1500 million active users, LinkedIn and Telegram have 760 million and 400 million active users respectively whereas Twitter has 330 million registered users, and Snapchat has 265 million active users.

Furthermore, the same technologies that encourage user participation make it easier for malware, such as worms that can be closed down corporate networks system or spyware and keyloggers that steal corporate data, to infect users. Employees can also mistakenly "leak" confidential firm information by posting images, videos, and audio recordings to sites.

Keywords: Threats, Defense, Firewall, Intrusion Detection, Anti-Malicious-Software systems, Vulnerability, Internet Service Provider, Multi-Factor Authentication, Cryptosystem.

**Threats:** Threats and risks abound, including some that are more threatening than others. Viruses that wipe out your overall system, someone getting into your device and altering files, someone using your computer to attack others, or even someone grabbing your credit card information and using it to make illicit purchases are all examples of these risks. Even with the best precautions, there's no guarantee that any of these incidents won't happen to you, although there are things you can do to minimize your risks.

**Defense:** Recognizing the hazards and learning some of the terminology connected with them will be the first step in protecting yourself.

- Hacker, attacker, or intruder
- Malicious code, Vulnerability

To preserve the integrity of an enterprise's data resources, the defense uses different security countermeasures in a coordinated manner. Malicious hackers' attempts are less likely to succeed when defense in depth is used. This type of approach can also help network managers and security personnel detect those who try to break into a computer, server, internal network, or (ISP) Internet service provider.

### Social Networking – Threats and Defense:

When sharing information on the web, people must be aware of the hazards and cautious about what they disclose and with whom.

Threat actors may exploit social media platforms to spread malicious code, infect a user's computer, or obtain personal information such as the identity of the user, address, contact info, and personal or business relationships. Certain actions may also unintentionally provide information to third parties. Some of the most prevalent risks to social networking sites are listed here.

**Viruses:** Social media platforms are an excellent target for cyber criminals wanting to make the biggest effect with the minimum of effort because of their widespread use. By creating a virus, inserting it in a webpage or a 3rd party, and then relying on individuals to transmit the dangerous links to their friends, an attacker can easily infect millions of computers. A virus can be transmitted by email attachments, corrupted files on floppy discs or CD-ROMs, or by exploiting a security hole in Microsoft Windows.

1. **Defense:**

- Maintain good anti-virus, anti-spyware, and firewall software by installing and updating them on a regular basis.
- Emails, advertisements, newsletters, and other forms of communication are used to raise awareness and educate people.
- Downloading software from unreliable web pages or other sources is not a good idea.
- Never run a .exe file that you haven't received from someone you don't know.
- Ensure that all software patches are installed and current.
- Have an outside team check the source code for backdoors
- Maintain the most recent version of your operating system.
- Increase the security settings on your browser.
- Avoid visiting any shady websites.
- Only download software from reputable sites. Before you download free software or file-sharing applications, give them a thorough examination.

2. **Tools:** To gain access to a customer's profile, cybercriminals may employ tools. The attacker has access to the user's personal information as well as the information of any contacts with whom the user has shared their information. If an attacker gains a login to a customer's profile, they can impersonate them and submit harmful content.

3. **Defense:**

- Download and install an Internet Security software suite, such as Norton Internet Security, which includes anti-spyware, anti-virus, and firewall protection.
- Before you surf the Internet or download email, make sure your Internet Security suite is up to date.
- If you've disabled Windows Automatic Updates, manually check for crucial updates from Microsoft Windows.
- Back up your critical files on a regular basis. As a general guideline, the more significant the information is and the more often it changes or is added to, the more frequent the backups should be.
- Never use a computer to access a website that contains your credit card or bank account information unless you are certain that the computer is virus-free.
- Examine your credit card and bank statements on a regular basis.
- Keep a close eye on demands for predatory conduct from online "friends" or acquaintances.
- If you agree to meet an internet "friend" or acquaintance in person, be extremely cautious.

4. **Social Engineering Attacks:** Threat actors could send an e - mail or make a post that appears to be from a trusted social media website or user. The message could contain a fake URL or an asking for personal information. If you follow the advice, you risk revealing sensitive information or risking the security of your system.

5. **Defense:**

- Never hand out personal information to someone you haven't verified through a third party. Internet searches can occasionally yield further information.
- User education via a portal, email newsletters, and customer meetings, among other things.
- Never give out your email address on a website that is unfamiliar to you.

6. **Identity theft:**

Threat actors might be able to gather adequate personally identifiable information from social media platforms to impersonate yourself or one of your friends. Threat actors may be able to deduce the answers to log-in or password reminder inquiries for mail, debit card, or banking information using just a few pieces of personal data.

**7. Defense:**

- Passwords that are extremely strong
- SSL (Secure Sockets Layer )
- Clear Screen / Desk Policy
- Effective Anti Spyware and virus
- Alertness

**8. Third-party applications:** Users may be able to add third-party apps, such as games and surveys, to some social networking services to provide extra features. Use caution when using these apps; even if they don't include harmful code, they may gain access to your profile information without your knowledge.

**Defense:**

- Don't give out your email address on dubious websites
- Use anti-spam filtering software
- Computer security
- User education
- Spam detection and blocking
- Always download software from reputable sources. While installing free software or data sharing applications, give them a thorough evaluation.

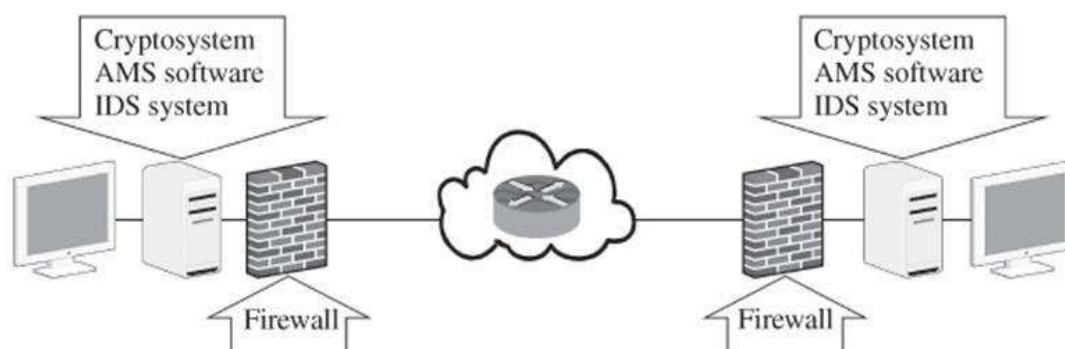
**Follow Good Practices**

Social networking platforms come with their own set of hazards, which you can mitigate by following basic security procedures.

1. Make sure your privacy and security settings are strong.
2. Third-party services that are suspicious should be avoided.
3. Everything should be treated as if it were public.
4. Only share with those you know.
5. Keep the quantity of personal information you share to a minimum.
6. Remember that the world wide web is a public resource.
7. Strangers should be avoided as much as possible.
8. Keep an open mind.
9. Examine your options.
10. Third-party Programmes should be avoided at all costs.
11. Make use of strong passwords.
12. Make sure to read the terms of service.
13. Keep your software up to date, especially your web browser.
14. Anti-virus software should be used and kept up to date.

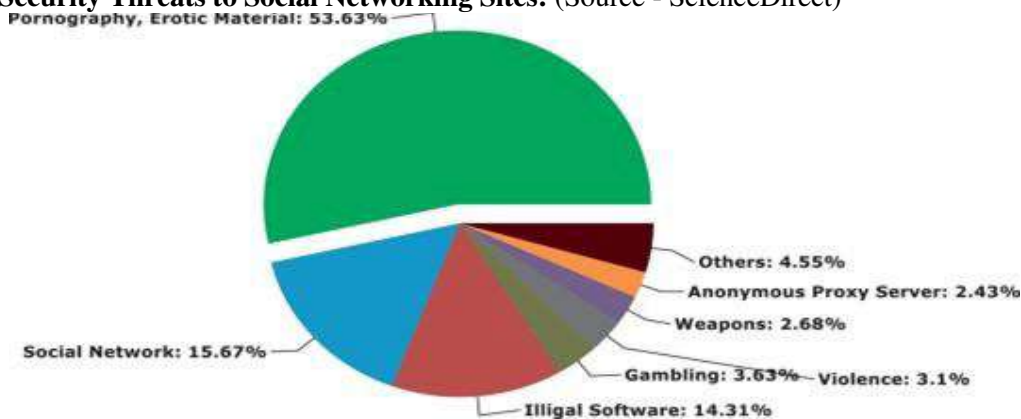
**Basic Security Model:**

The core security paradigm consists of cryptographic techniques, gateways, (AMS software) anti-malicious software systems, and (IDS) intrusion detection systems.



- Infrastructure for Network Security (SSL, Firewall, NIPS, HIPS with Good AV and Anti Spyware on the server and gateway)
- Firewall for Web Applications
- Server Vulnerability Analysis and Penetration Testing should be performed on a regular basis.
- Multi Factor Authentication

**2020's Top Security Threats to Social Networking Sites:** (Source - ScienceDirect)



- Cyber security threats, like the coronavirus pandemic, will happen on a worldwide scale every few seconds in 2020.
- Cyber safety similar to how the coronavirus spreads from individual to individual, malware can spread fast from device to device and network to network.
- Cyber-attacks, like the recent coronavirus epidemic, have the potential to put you out of business.

**There are various cyber security threats businesses face in 2020:**

- Phishing attacks: phishing scams frequently employ social engineering to get login information for both on-campus as well as cloud-based attacks.
- Remote worker endpoint security: remote workers commonly work without network security protection, which means they're missing out on an important part of multilayer cyber defence.
- Iot devices: it's difficult to keep up with the rapid growth of new iot devices while developing cyber security solutions.
- Sophisticated and targeted ransomware attacks: a single ransomware attack can do significant damage to small and midsize businesses, resulting in costly downtime and recovery costs.
- Deep fakes: when artificial intelligence (ai) and machine learning are used to alter a current photograph or video of a person to portray an incident that didn't happen, it is referred to as a deep fake.
- Mobile malware: mobile malware is software designed to especially attack android mobile operating systems. As more crucial and sensitive processes are performed on cellphones, it's just a question of time until mobile malware emerges among the most serious cyber security issues. (2020, emmitt)

**CONCLUSION**

On social networking sites like Facebook, WhatsApp, Snapchat, Instagram, YouTube, LinkedIn, and Wikipedia, as well as Web services like eBay and Gmail, blog posts, Newsfeeds, podcasts, and certain other technologies enable self-publishing and strong interactivity between users. These sites get a large number of visits, which makes them very appealing to hackers. Social networking services are designed to bring as many people together as possible on one platform, and there is a high return on investment for attackers in doing so. One of the most practical techniques for improving IT security is to restore your systems and SaaS app data to enable efficient and quick recoveries from cyber-attacks. Automate patch and vulnerability management to keep your systems up to date and secure against cyber threats. Make very sure that every computer or gadget that leaves the workplace is equipped with a comprehensive security suite, including a local firewall and powerful malware detection. To better cope with the attack and get your firm back on the right track as early as possible, you'll also need a strong plan of action. Because "prevention is better than cure," we must all take maximal precautions while using social networking sites.

## REFERENCES

- [1] Cert, U. (n.d.). Tips. Retrieved December 10, 2020, from <http://www.us-cert.gov/cas/tips/ST06-003.html>
- [2] Coob, M. (n.d.). Social networking website threats manageable with good enterprise policy. Retrieved December 18, 2020, from <http://searchsecurity.techtarget.com/tip/Social-networking-Web-site-threats-manageable-with-good-enterprise-policy>
- [3] CSOonline. (n.d.). csoonline.com Website. Retrieved from <http://www.csoonline.com/>
- [4] CSOOnline. (n.d.). LinkedIn-facebook-twitter-users-beware. Retrieved Jan 12, 2021, from <http://www.csoonline.com/article/474868/linkedin-facebook-twitter-users-beware>
- [5] CSOOnline, C. . (n.d.). Seven\_Deadly\_Sins\_of\_Social\_Networking. Retrieved December 10, 2021, from [http://www.csoonline.com/article/496314/Seven\\_Deadly\\_Sins\\_of\\_Social\\_Networking\\_Security](http://www.csoonline.com/article/496314/Seven_Deadly_Sins_of_Social_Networking_Security)
- [6] Emmitt, J. (2020, April 15). Top 10 Cybersecurity Threats in 2020. Retrieved from <https://www.kaseya.com>: <https://www.kaseya.com/blog/2020/04/15/top-10-cybersecurity-threats-in-2020/>
- [7] India, C. (2011, December 12). CERTIn Security Guideline.
- [8] India, C. (2011, December 16). Current Security Threats and Trends . p. 79.
- [9] Morda, M. M. (2011, December 11). Socializing Securely: Using Social Networking Services. p. 5.
- [10] Virus, S. &. (n.d.). Security Threats. p. 34.



## **A Study on the Sustainable Development Knowledge, Attitudes and Behaviours of Prospective Teachers in Manipur**

**Chongtham Khogendra Singh<sup>1</sup>, Sarungbam Sen Singh<sup>2</sup> and H. Ibomcha Sharma<sup>3</sup>**

<sup>1</sup>Department of Teacher Education, Manipur University, Imphal, India

<sup>2</sup>Department of Physical Education and Sports Science, Manipur University, Imphal, India

<sup>3</sup>Department of Education, NG College, Imphal, India

### **ABSTRACT**

The researchers attempted to determine whether the level of sustainable development knowledge, attitudes, and behaviours among prospective teachers varies significantly depending on age, gender, and educational qualification in this paper. The survey was completed by a total of 625 respondents who were chosen at random from 12 B.Ed. training institutes in Manipur. They ranged in age from 23 to 45 years old. The data was collected during February 2020 through a data collection tool, the five-point Likert Scale designed by the researchers, including three subscales of knowledge, attitudes, and behaviours relating to SD. IBM SPSS Statistics Version 22 was used for the statistical analysis of the data. In the analysis of the data, descriptive statistics such as percentages, mean, standard deviation, and Independent Samples t-test were employed. The findings revealed that: 1) graduate degree holder prospective teachers had better SD knowledge than their post-graduate degree holder counterparts; 2) female prospective teachers had better SD attitudes than their male counterparts; 3) female prospective teachers had better SD behaviours than their male counterparts; 4) older prospective teachers performed better on the SD attitudes than their younger counterparts; and 5) graduate degree holder prospective teachers performed better on the SD attitudes than their younger counterparts. It is concluded that the researchers should broaden their target population to see what kinds of gender-related, age-related, and educational qualification-related knowledge, attitudes, and behaviours exist in those areas.

Keywords: attitude, behaviours, knowledge, prospective teachers, sustainable development

### **1.1 INTRODUCTION**

The United Nations designated the 2005–2014 period as the Decade of Education for Sustainable Development (DESD), which has affected curriculum at all levels of education (e.g., NCF, 2005 and NCFTE, 2009). The DESD's major goal was to integrate SD at all levels of educational systems across the world. Researchers and policymakers have emphasised the necessity of a teaching method known as Education for Sustainable Development (ESD), which allows teachers to address the complexities of SD in the classroom (Sandell et al., 2005; Wals, 2011). The Education for Sustainable Development has its roots in conventional environmental education since it has consistently driven for aims and outcomes similar to and equivalent to those inherent in the principles of sustainable development (UNESCO, 2002).

Every teacher, therefore, can be a vital player in bringing about the necessary changes in beliefs and lifestyles of people for sustainable development to be a reality. To realise this potential, teacher education is required to be revamped. Accordingly, various basic teacher education courses have been augmented to a two-year degree programme comprising four semesters under the aegis of NCTE across India and new subject such as environmental education has been added as compulsory paper. Furthermore, prospective teachers who will create and administer school curricula in the future must possess specialised knowledge, favourable attitudes, and desired behaviours towards various aspects of SD. Prospective Teachers are those trainees who have been enrolled in a teacher education programme. Teacher education programmes can also give practical experiences that motivate prospective teachers to continue their professional growth after they graduate.

The intent of the current research, therefore, is to provide a better understanding of disparities in prospective teachers' knowledge, attitude, and behaviours about sustainable development depending on their gender, age, and educational qualification.

### **1.2 RESEARCH QUESTIONS**

- Do the prospective teachers' scores of knowledge, attitude and behaviours toward sustainable development vary significantly depending on gender?
- Do the prospective teachers' scores of knowledge, attitude and behaviours toward sustainable development vary significantly depending on age?
- Do the prospective teachers' scores of knowledge, attitude and behaviours toward sustainable development vary significantly depending on educational qualification?

## 2. METHODOLOGY

**2.1 Method:** The study employed the descriptive survey method.

**2.2 Participants:** The study group of the current research is comprised of 625 prospective teachers undergoing B.Ed. 1<sup>st</sup> Semester at 12 B.Ed. training institutes in Manipur. Of the participating prospective teachers, 44% are males and 56% are females. Of the prospective teachers, 40% are younger (below 30 years) and 60% are older (above 30 years). Of the total 625 prospective teachers, 24% are graduate degree holders and 76% are post-graduate degree holders.

**2.3 Data Collection Tool:** To collect data, the "Sustainable Development Knowledge, Attitude, and Behaviours Scale" developed by the investigators was used. The whole scale consists of 60 items designed in the form of a five-point Likert scale, ranging from "Strongly Disagree: 1" to "Strongly Agree: 5". The minimum score to be taken from the scale is 60, and the maximum score is 300. The scale used in the study consists of 3 subscales. These subscales are: SD knowledge (20 items), SD attitude (20 items) and SD behaviours (20 items). The Cronbach's alpha reliability coefficient of the whole scale was found to be 0.80. The Cronbach's alpha values of the subscales knowledge, attitude and behaviours were found to be 0.84, 0.82 and 0.83 respectively.

**2.4 Analysis:** IBM SPSS Statistics Version 22 was used for the statistical analysis of the data. In the analysis of the data, descriptive statistics such as percentages, mean, standard deviation, and Independent Samples t-test were employed. The significant level was set at 0.05.

## 3. THE RESULTS

**Research Question No. (a):** Do the prospective teachers' scores of knowledge, attitude and behaviours toward sustainable development vary significantly depending on gender?

**Table 1:** Group statistics and Independent Samples Test (Gender)

Dependent variables	Gender	N	M	SD	t	Sig. (2-tailed)	d
SD Knowledge	Male	274	70.31	10.19	1.44	0.15	0.12.
	Female	351	71.45	9.32			
SD Attitudes	Male	274	73.17	10.32	2.12*	0.04	0.17
	Female	351	74.84	9.08			
SD Behaviours	Male	274	72.97	9.89	2.73*	0.01	0.22
	Female	351	75.08	9.19			

\*significant at 0.05 level

**Sources:** Computed from the survey data, February 2020

The results indicated a non-significant difference between male and female prospective teachers in SD knowledge,  $t_{(623)} = 1.44$ ,  $p = 0.15$ ,  $d = 0.12$ . The results revealed a significant difference between male and female prospective teachers in SD Attitudes,  $t_{(623)} = 2.12$ ,  $p = 0.04$ ,  $d = 0.17$ . Female prospective teachers exhibited better SD Attitudes than their male counterparts. The results revealed a significant difference between male and female prospective teachers in SD Behaviours,  $t_{(623)} = 2.73$ ,  $p = 0.01$ ,  $d = 0.22$ . Female prospective teachers exhibited better SD Behaviours than their male counterparts.

**Research Question No. (b):** Do the prospective teachers' scores of knowledge, attitude, and behaviours toward sustainable development vary significantly depending on age?

**Table 2:** Group statistics and Independent Sample Test (Age)

Dependent variables	Age	N	M	SD	t	Sig. (2-tailed)	d
SD Knowledge	Younger	251	70.52	10.23	0.88	0.38	0.07
	Older	374	71.24	9.36			
SD Attitudes	Younger	251	73.00	10.47	2.28*	0.02	0.19
	Older	374	74.85	9.03			
SD Behaviours	Younger	251	73.34	10.04	1.72	0.09	0.14
	Older	374	74.70	9.19			

\*significant at 0.05 level

**Sources:** Computed from the survey data, February 2020

The results reveal a non-significant difference between younger and older prospective teachers in SD knowledge,  $t_{(623)} = 0.88$ ,  $p = 0.38$ ,  $d = 0.07$ . The results reveal a significant difference between younger and older prospective teachers in SD Attitudes,  $t_{(623)} = 2.28$ ,  $p = 0.02$ ,  $d = 0.19$ . Older prospective teachers

performed better on the SD Attitudes than their younger counterparts. The results reveal a non-significant difference between younger and older prospective teachers in SD Behaviours,  $t_{(623)} = 1.72, p = 0.09, d = 0.14$ .

**Research Question No. (c):** Do the prospective teachers' scores of knowledge, attitude, and behaviours toward sustainable development vary significantly depending on educational qualification?

**Table 3:** Group statistics and Independent Samples Test (Educational Qualification)

Dependent variables	Educational qualifications	N	M	SD	t	Sig. (2-tailed)	d
SD Knowledge	Graduate	151	73.70	9.90	4.05*	<.001	0.37
	Post-graduate	474	70.07	9.50			
SD Attitudes	Graduate	151	73.55	10.42	0.818	0.41	0.07
	Post-graduate	474	74.29	9.42			
SD Behaviours	Graduate	151	73.34	9.88	1.196	0.23	0.11
	Post-graduate	474	74.41	9.45			

\*significant at 0.05 level

**Sources:** Computed from the survey data, February 2020

The results reveal a significant difference between graduate degree holder prospective teachers and post-graduate degree holder prospective teachers in SD knowledge,  $t_{(623)} = 4.05, p < .001, d = 0.37$ . Graduate degree holder prospective teachers possessed better SD Knowledge than their post-graduate degree holder counterparts. The results reveal a statistically non-significant difference between graduate degree holder prospective teachers and post-graduate degree holder prospective teachers in SD Attitudes,  $t_{(623)} = .818, p = 0.41, d = 0.19$ . The results indicate a non-significant difference between graduate degree holder prospective teachers and post-graduate degree holder prospective teachers in SD Behaviours,  $t_{(623)} = 1.20, p = 0.23, d = 0.11$ .

#### 4. DISCUSSIONS

For SD knowledge, our results indicated a non-significant difference between male and female prospective teachers. However, Tuncer (2008) reported a significant difference between males and females in respect of their SD knowledge. Another previous study found that females were more knowledgeable about SD than males (Al-Naqbi & Alshannag, 2018). However, other studies also found that females possessed less SD knowledge than males did (Levine & Strube, 2012; Mustafa, 2007). As a result, while we believe that gender is an important and fascinating topic, we also believe that gender may not be the decisive factor that leads to men and women having different SD knowledge. Our results also indicated a non-significant difference between younger and older prospective teachers in SD knowledge. Contrary to our finding, other studies suggest that an increase in age affects an increase in SD knowledge (e.g., Aminrad, Zakaria, & Hadi, 2011). Though older people are more likely to engage with nature, the effect of age on SD knowledge is negligibly small (Wiernik, Ones & Dilchert, 2013). Thus, not convincing enough research evidence has been found on age differences and their influences on knowledge concerning sustainable development. Our results indicated a significant difference between prospective teachers with graduate degrees and post-graduate degree holders in SD knowledge. Graduate degree holders possessed better SD knowledge than their post-graduate degree holder counterparts. A Paul & Mehera (2016) study revealed a positive association between education level and sustainable development. However, Hamilton (2008) argues that education level does not have a simple positive effect, but rather it is, if any, overshadowed by ideological moorings.

For SD attitudes, our results indicated a significant difference between male and female prospective teachers. Female prospective teachers exhibited better SD attitudes than their male counterparts. However, another study found that the SD attitudes of prospective teachers do not vary significantly by gender (Keles, 2017). While some studies have found a significant male advantage (e.g., Biasutti & Surian, 2012). Our results indicated a significant difference between younger and older prospective teachers. Older prospective teachers performed better on the SD Attitudes than their younger counterparts. Our finding is in line with other previous research (Shen & Saijo, 2008; Wiernik, Ones, & Dilchert, 2013). In contrast to our findings, other studies have found that younger people have significantly more positive attitudes than older people (Shaukat, 2016; Kuchinka, Balazs, Gavrilitea, & Djokic, 2018). Our results indicated a non-significant difference in SD Attitudes between prospective teachers with graduate degrees and post-graduate degree holders. A Paul & Mehera (2016) study revealed a positive association between education level and sustainable development. However, Hamilton (2008) argues that educational level does not have a simple positive effect, but rather it is, if any, overshadowed by ideological moorings.

For SD Behaviours, our results indicated a significant difference between male and female prospective teachers. Female prospective teachers exhibited better SD behaviours than their male counterparts. Our finding conforms to other studies (e.g., Krauss, 1993; Zelezny et al., 2000; Vainio & Paloniemi, 2014). Our results indicated a non-significant difference between younger prospective teachers and older prospective teachers in SD Behaviours. It could be that the effect of age differences is weakening as climate change becomes more accepted and different generations experience its effects, such as sea-level rise, species loss, and extreme climatic events (Smith & Kingston, 2021). Our results indicated a non-significant difference between prospective teachers with graduate degrees and post-graduate degree holders in SD Behaviours. Contrary to our finding, other studies have found that higher educational attainment, in general, is associated with higher levels of environmental concern (Gifford & Nilsson, 2014; Liere & Dunlap, 1980). However, it is unclear whether there is a causal relationship. Individuals, in other words, decide how much education they want and how they want to act in connection to the environment (Meyer, 2015).

## 5 CONCLUSIONS

This article provides a comprehensive comparison of gender, age, and educational qualification differences of prospective teachers in knowledge, attitude, and behavior relating to sustainable development by integrating the previous findings and examining multiple reasons behind this difference. While an increasing number of academics have begun to pay attention to gender, age, and educational attainment level disparities in Sustainable Development knowledge, attitudes, and behaviours, present research still has several limitations, and some topics require more investigation. As a result, it's also crucial to look into whether there are any other contributing elements or explanations for the gender, age, and educational qualification disparities in other population. Since there may be available more possible perspectives for us to explore the strategies of improving the sustainable development of both men and women, old and young, and graduates and post-graduates. Furthermore, as this article pointed out, a huge portion of different results are obtained in research conducted in various countries, but for the time being, the majority of data is still drawn from developed regions. As a result, future researchers should broaden their target population by conducting studies in many regions, particularly those that are less developed, to see what kinds of gender-related, age-related, and educational qualification-related knowledge, attitudes, and behaviours exist in those areas.

## REFERENCES

1. Al-Naqbi, A., & Alshannag, Q. (2018). The status of education for sustainable development and sustainability knowledge, attitudes, and behaviors of UAE university students. *International Journal of Sustainability in Higher Education*, 19(3), 566-588.
2. Aminrad, Z., Zakaria, S., & Hadi, A. (2011). Influence of Age and Level of Education on Environmental Awareness and Attitude: Case Study on Iranian Students in Malaysian Universities. *The Social Sciences*, 6, 15-19.
3. Gifford, R., & Nilsson, A. (2014). Personal and social factors that influence pro-environmental concern and behaviour: A review. *International Journal of Psychology*, 49(3), 141-157.
4. Hamilton, L.C. (2008). Who cares about Polar Regions? Results from a survey of U.S. public opinion. *Arct Antarct Alp Res*, 40(4), 671-678.
5. Keleş, Ö. (2017). Investigation of Pre-Service Science Teachers' Attitudes towards Sustainable Environmental Education. *Higher Education Studies*, 171-180, 7(3).
6. Krauss, C. (1993). Women and toxic waste protests: race, class and gender as resources of resistance. *Qual. Sociol.*, 16, 247-262.
7. Kuchinka, D. G., Balazs, S., Gavriletea, M. D., & Djokic, B.-B. . (2018). Consumer Attitudes toward Sustainable Development and Risk to Brand Loyalty. Retrieved from C:/Users/user/ AppData/Local/Temp/ sustainability-10-00997.pdf.
8. Levine, D., & Strube, M. (2012). Environmental attitudes, knowledge, intentions and behaviors among college students. *The Journal of Social Psychology*, 152(3), 308-326.
9. Liere, K. D. V., & Dunlap, R. E. (1980). The social bases of environmental concern: A Review of hypotheses, explanations and empirical evidence. *The Public Opinion Quarterly*, 44(2), 181-197
10. Meyer, A. (2015). Does Education Increase Pro-Environmental Behavior? Evidence from Europe. *Ecological Economics*, 116, 108-121.

11. Mostafa, M. (2007). Gender differences in Egyptian consumers' green purchase behavior: the effects of environmental knowledge, concern, and attitude. *International Journal of Consumer Studies*, 31(3), 220-229.
12. National Curriculum Framework (NCF), 2005. National Council for Educational Research and Training (NCERT), Sri Aurobindo Marg NEW DELHI-110016
13. National Curriculum Framework for Teacher Education (NCFTE), 2009. National Council For Teacher Education, Bhubaneshwar, India.
14. Paul, P. K., & Mehera, C. (2016). Impacts of Education on Sustainable Development: A Micro Study in Burdwan District of West Bengal, India. *American Journal of Educational Research*, 4(7), 551-555.
15. Sandell, K.; Öhman, J.; Östman, L.; Billingham, R. & Lindman, M. (2005). *Education for Sustainable Development: Nature, School and Democracy*. Lund: Studentlitteratur.
16. Shaukat, S. (2016). Prospective Teachers' Attitudes towards Social and Environmental Aspects of Education for Sustainable Development. *Pakistan Journal of Social and Clinical Psychology*, 14(1), 36-41.
17. Shen, J., & Saijo, T. (2008). Reexamining the relations between socio-demographic characteristics and individual environmental concern: Evidence from Shanghai data. *J. Environ. Psychol*, 28, 42-50.
18. Smith, M. A. & Kingston, S. (2021). Demographic, Attitudinal, and Social Factors That Predict Pro-Environmental Behavior. *Sustainability and Climate Change*, 14 (1). 47-54.
19. Tuncer, G. (2008). University students' perception on sustainable development: a case study from Turkey. *International Research in Geographical and Environmental Education*, 17(3), 212-226.
20. Tuncer, G., Ertepinar, H., Tekkaya, C., & Sungur, S. (2005). Environmental attitudes of young people in Turkey: Effects of school type and gender. *Environmental Education Research - ENVIRON EDUC RES*. 11. 215-233. 10.1080/1350462042000338379.
21. UNESCO. (2002). *Education for Sustainability – From Rio to Johannesburg: Lessons learnt from a decade of commitment*; retrieved on 4/9/2019 from <http://unesdoc.unesco.org>.
22. Vainio, A., & Paloniemi, R. (2014). The complex role of attitudes toward science in pro-environmental consumption in the Nordic countries. *Ecol. Econ*. 108, 18-27.
23. Wals, A. E. J. (2011). Learning Our Way to Sustainability. *Journal of Education for Sustainable*, 5 (2), 177-186.
24. Watling, A. & Zhou, E. (2011). *Attitudes towards Sustainability: A Quantitative Study of Sustainable Ålidhem*. (Thesis). Umeå School of Business. Spring semester.
25. Wee, M.I., Ariffin, F.N., Ng, T.F., & Shabudin, A.F.A. (2017). Awareness and Attitudes towards Sustainable Development amongst Higher Education Students in Penang, Malaysia. In W. Leal Filho, U. Azeiteiro, F. Alves, & P. Molthan-Hill, *Handbook of Theory and Practice of Sustainable Development in Higher Education*. World Sustainability Series. Cham: Switzerland: Springer.
26. Wiernik, B. M., Dilchert, S., & Ones, D. (2016). Age and Employee Green Behaviors: A Meta-Analysis. *Frontiers in psychology*, 7, 194.
27. Zelezny, L., Chua, P., & Aldrich, C. (2000). Elaborating on gender differences in environmentalism-statistical data included. *J. Soc. Issues*, 56, 443-445.

## Analysis and Weight Optimization of Four-Wheeler Steering Yoke

Shrikant Kanade<sup>1</sup> and Prashant Anerao<sup>2</sup>

<sup>1</sup>M. Tech Design, VIIT, Pune, India

<sup>2</sup>Mechanical Engineering, VIIT, Pune, India

### ABSTRACT

The current automotive industry's top priority is to reduce the weight of automobile components. A steering yoke is the critical component of a vehicle, which links the suspension and the steering system. They are used to transmit the motion or power of the driveline system. Each automobile consists of a different power transmission system depending upon the vehicle driveline system. Finite element analysis of the component is carried out to find the displacement and stress of the existing and optimised product. For modelling the component, CATIA V5 R20 software is used. Pre-processing like meshing is done in a HYPERMESH 2019 and analysis work is carried out in ANSYS 19 software. With the help of FEA analysis, we have identified the characteristics and nature of stresses acting on the yoke. This paper focuses on the optimization of the steering yoke by aiming for stress uniformity while maintaining the structure's required strength and stiffness. CATIA has been used to create a CAD model of the steering yoke. An ANSYS workbench solver has been used to prepare a finite element model. ANSYS has been used to prepare a finite element model with an ANSYS workbench solver. The Topology optimization tool is used to find out the material-removing area of the steering yoke. The steering yoke is redesigned for weight optimization, and finally, FEA is performed on an optimised model to check whether the design is safe or not. The existing model is modified as per the optimised model geometry and a torsional test is conducted on it to compare experimental results with numerical results.

Keywords: - FEA, 3D modelling, Steering yoke, Topology optimization

### 1.INTRODUCTION

Growing competition and innovation in the automobile industry necessitate either the enhancement of existing products or the replacement of old ones with new and advanced types of material products. To conserve our natural resources as well as energy, automobile manufacturers are currently focusing on reducing weight. The weight of the vehicle continues to rise because of the added luxury and safety features, reducing fuel efficiency as well as overall performance. As a result, reducing the weight of the automobile is the current automotive industry's top priority.

Turning motions applied to the steering wheel via the steering shaft are converted to transverse lateral movement of a rack gear by the steering gear assembly. The steering gear assembly consists of a rack and a pinion gear that work together to turn the front wheels of a vehicle to steer it. Shocks and various loads from the front tyres and wheels are applied to the steering gear assembly. If the rack and pinion gear are not held in place, it may cause the rack and pinion gear to disengage in extreme conditions. The universal joint is used to connect the rack and pinion gear.

A universal joint is a type of joint or coupling that allows a rod to bend in any direction. It is commonly used in shafts that transmit rotary motion. Universal joints can transmit torque and rotational motion from one shaft to another when their axes are inclined to each other by an angle that varies depending on the working conditions. It is made up of two yokes that are 90<sup>0</sup> degrees apart and are connected by a cross/spider. It is widely used to connect misaligned shafts in industrial applications and vehicle drivelines.

The steering yoke is a critical component of a vehicle that connects the suspension and steering system. S.G. Solanke researched on the failure study of steering yoke assembly, it shows that 66% of failure occurs in yoke part only [10].

The steering yoke assembly associated with this project work consists of two yokes/forks connected to two shafts that are coupled and at right angles to each other. However, the single component known as the 'Yoke' would be the focus of this research. These two yokes are joined by a spider or cross. Since the arms of the spider are at right angles. The fig.1 shows the universal joint of Tata Sumo which used for current study.



**Fig.1** Universal Joint of Tata Sumo

As there are many cases of universal joint failures, several researchers studied them. According to H. Bayrakceken[1], yoke failures occur because of the fatigue process, and the crack beginning location of the joint yoke corresponds to the highest stress points. Farzad Vesali[9] studied the failure of universal joint bearings and its reasons. P.G. Tathe[11] reviewed on different types of universal joint failures such as Brinelling, Spalling, Burned U-joint cross Trunnions, deflected end fitting.

Abhishek Mandal[5] done the FEA analysis of universal joints for stress and deformation calculations using Ansys. Ananthu S Kumar[4] has used the FEM method to analyse universal joints at various working angles and materials in order to reduce the time to failure of the universal joint. Maram[6] compared the various materials for stress calculations.

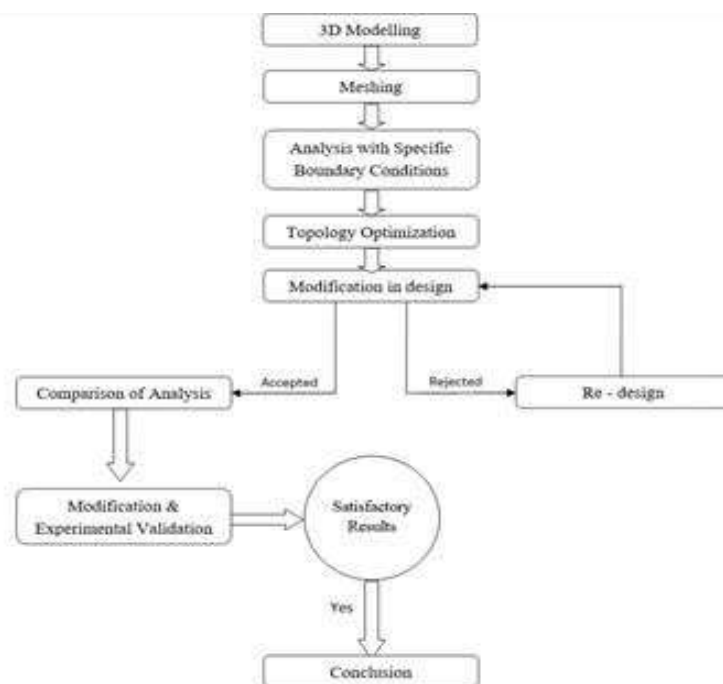
Some researchers analysed and optimised the design of universal joint. Sunil Chaudhry[3], S.K.Chandole[8] investigated and analysed the stress distribution of the universal yoke at the real engine condition during power transmission and weight reduction by modifying the dimensions. The same approach has used by Vishal Rathi[2] for analysis of universal joint of Tata 407 using FEM method. Dhananjay S Kolekar [7] done the numerical test and experimental test on universal joint for comparing their results between existing and modified products. Also used the topology optimisation methods for mass reduction of yoke.

## 2.PROBLEM STATEMENT

Yoke assemblies are subjected to torsional stresses due to working conditions. The steering yoke being a component posing threat to the ‘safety’ of the vehicle and its occupants, the design of the same needs to be reviewed for ensuring structural integrity. Also, now-a-days it is required to compete for car manufacturers in the field of efficiency and fuel consumption which is main concern in automobile industry. So, to avoid the overweight, it is necessary to reduce the unwanted weight of the steering yoke.

## 3.METHODOLOGY

Following flowchart shows the methodology to be carried out towards the completion of project.



**Fig.2** Methodology flow chart

#### 4. NUMERICAL ANALYSIS

##### 4.1 3D MODEL OF UNIVERSAL JOINT:

Figure. 3 shows CAD model of Universal joint. The CAD model is prepared in the CATIA software. This 3D model consists different components like Yoke, cross and pin. While assembling the yoke to cross, pins were used for fitments.

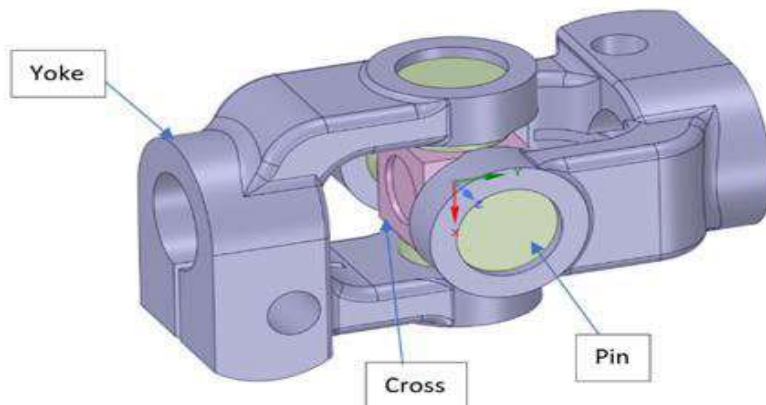


Fig.3 Assembly of Universal Joint

##### 4.2 MATERIAL USED AISI 4140:

The material of all components is considered as AISI 4140. Following are the properties of AISI 4140:

Table 1. Properties of AISI 4140

Property	Value of AISI 4140
Density	7850 kg/m <sup>3</sup>
Young's modulus	205 GPa
Ultimate tensile strength	655 MPa
Yield tensile strength	415 MPa
Poisson's Ratio	0.28

##### 4.3 MESHING OF GEOMETRY:

Meshing is an operation where the FE-model is divided into small, structured elements. Hypermesh 2019 software is used mesh the solid model. Cad model which is in IGES format is imported to Hypermesh 2019 for meshing. The meshing of the yoke need to be done effectively because the quality of the mesh is directly proportional to the result of FEA[9]. The YOKE was discretized in finite 3D Tetra elements taking overall element size as 2 mm in fig. Also, the meshing features such as curvature and proximity were taken into consideration to ensure proper and accurate high-quality mesh.

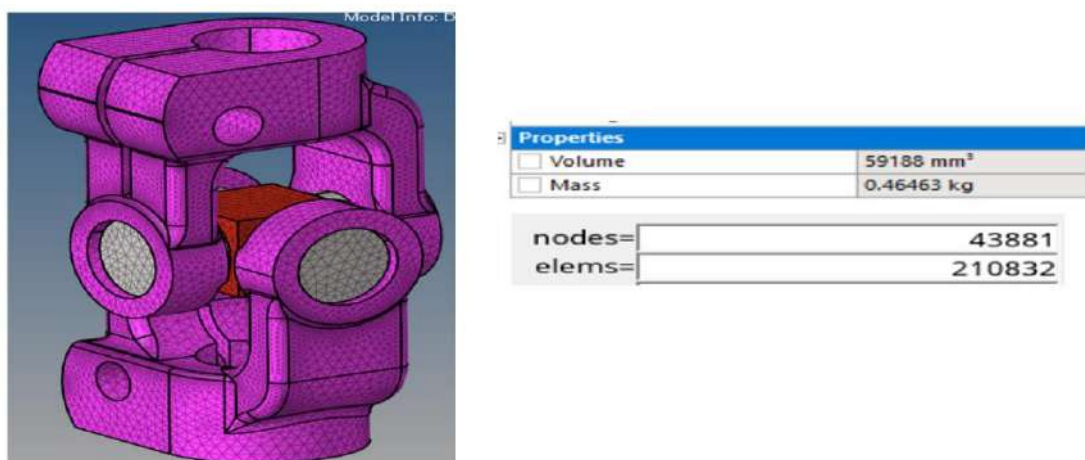


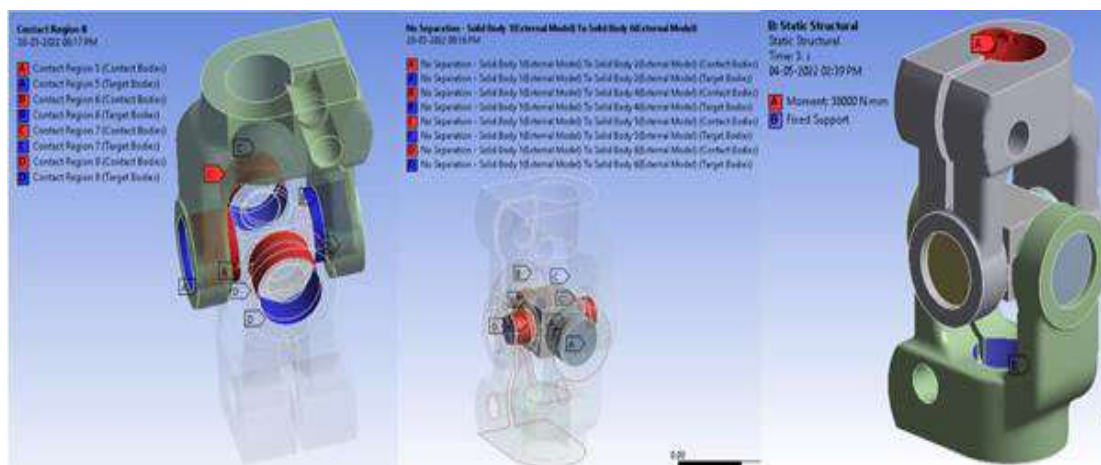
Fig.4 Meshed Assembly

##### 4.4 BOUNDARY CONDITIONS AND LOAD

The application of load and the definition of constraints in the model are both involved in boundary conditions. For this universal joint, the loading is assumed to be 38 Nm torque applied at top of yoke. Bonded condition is



applied between external bush & internal hole of yoke surface. No separation condition is applied between spider & internal bush surface. Following fig shows the boundary conditions applied on the universal joint.



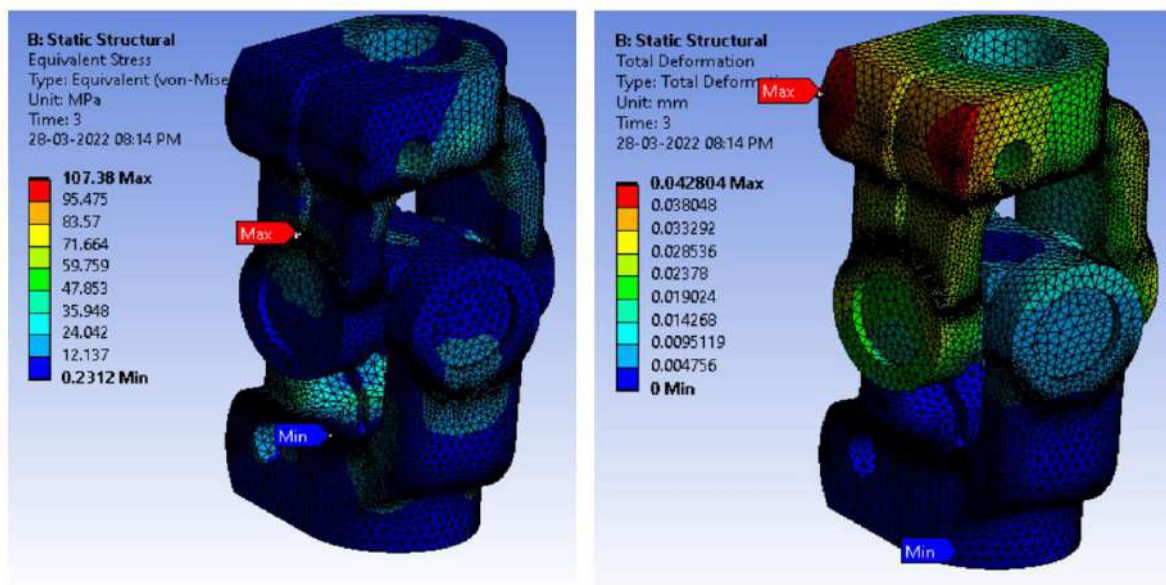
**Fig.5** Boundary Conditions and Loads

#### 4.5 STRUCTURAL ANALYSIS OF EXISTING STEERING YOKE:

The universal joint when analyzed in ANSYS using above boundary and loading conditions as in case of the yoke. The following are the two most important findings:

- 1) Von-Mises Stress
- 2) Deformation.

Firstly, the component has been analyzed for that Von Mises stress and deformation. The maximum Von Mises stress encountered is 107.38 MPa and total deformation is 0.0428 mm.



a) Von Mises Stress for Existing Yoke

b) Total Deformation for Existing Yoke

**Fig.6** FEA Analysis of existing universal joint

#### 4.6 OPTIMIZATION APPROACH:

Maximum stresses observed in existing steering yoke are less than the material's yield stress. Stresses are below the yield limit. A weight reduction scope has been identified for this work.

#### WEIGHT OPTIMIZATION APPROACH

The goal of Steering Yoke topology optimization is to find the best use of material for a body given constraints (deflection, volume, or mass reduction). Topology optimization is a mathematical method that optimizes material layout within a given design space for a given set of loads, boundary conditions, and constraints to maximize system performance. Basically, topology optimization is imposed before shape or size optimizations.

The removal area is set to 40%. Following fig. shows the material can be removed from upper portion of yoke near hole.



Fig.7 Material to be removed

#### 4.7 ITERATIVE ANALYSIS RESULTS:

The no of iterations is to be performed on the steering yoke assembly and geometrical variation carried out. The various type of geometrical shapes (fillets) are generated with various dimensions. By using same boundary conditions which are applied for existing assembly, the static structural analysis done on performed iterations. The results are numerically calculated in the table 2 below.

Table 2. Iterative analysis for optimization

Iteration	Values for GRA			Values for TOPSIS		
	Stress (MPa)	Deformation (mm)	Mass (gm)	Stress reduction (%)	Deformation reduction (%)	Mass reduction (%)
Iteration 1	90.624	0.044676	451.47	15.61	-4.38	2.84
Iteration 2	90.959	0.040535	440.05	15.3	5.31	5.3
Iteration 3	92.359	0.04058	443.24	13.99	5.2	4.61
Iteration 4	95.09	0.039961	436.03	11.45	6.65	6.16
Iteration 5	94.399	0.039852	428.11	12.09	6.9	7.87
Iteration 6	94.349	0.039321	425.84	12.14	8.14	8.35
Iteration 7	95.686	0.039856	442.27	10.9	6.89	4.82
Iteration 8	92.556	0.040176	444.91	13.81	6.14	4.25
Iteration 9	94.123	0.040454	440.68	12.35	5.5	5.16

#### 4.8 OPTIMIZATION USING GREY RELATIONAL ANALYSIS (GRA) & TOPSIS METHODS:

Using the Grey Relational Analysis technique, the analyzed numerical values are yielded the above response values of stress, deformation and mass which are presented in table 2. Iteration 6 has the highest value of grey relational grade, and it was allotted as rank one. For ensuring the optimized result TOPSIS method is used. By referring the values of stress reduction, deformation reduction, mass reduction in percentages for finding the optimized solution using TOPSIS method. By using TOPSIS, iteration 6 has the maximum closeness coefficient. Hence by comparing both methods, iteration 6 has optimized solution. Table 3 shows the ranking of process parameters generated by the conduct of GRA and TOPSIS method.

Table 3. Optimization using Ranking

Iteration	GRA Rank	TOPSIS Rank
Iteration 1	7	9
Iteration 2	3	5
Iteration 3	6	8
Iteration 4	5	3
Iteration 5	2	2
Iteration 6	1	1
Iteration 7	8	4
Iteration 8	4	6
Iteration 9	9	7

#### 4.9 OPTIMIZED GEOMETRY

The following geometry is generated by iteration 6 having mass of 425.84gm. The fillet is provided to both sides of yoke. In discretization, the number of nodes and elements are reduced.

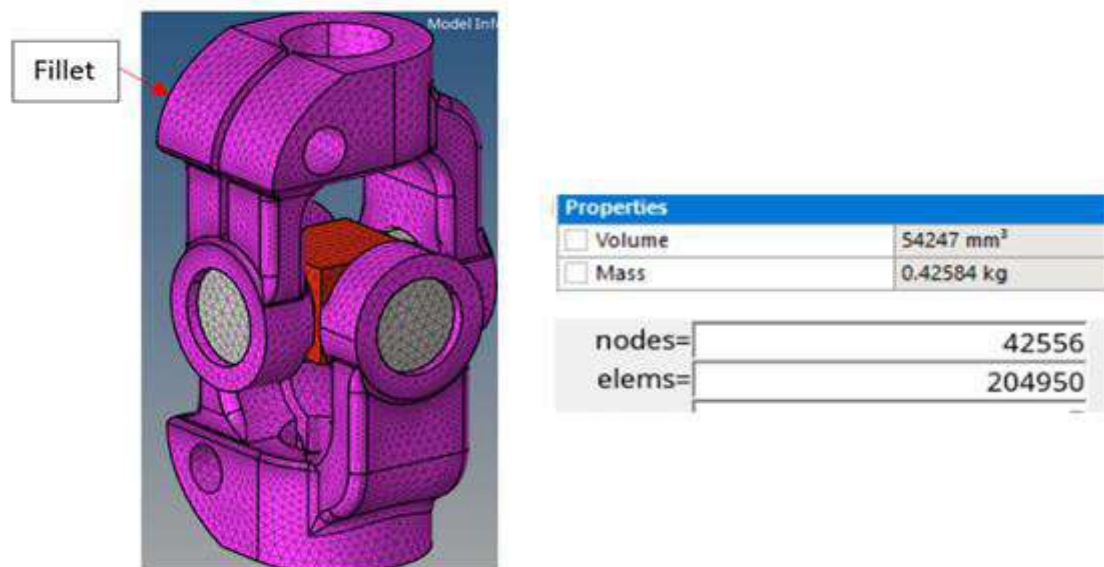


Fig.8 Meshing of Optimized universal joint

#### 4.10 ANALYSIS RESULTS:

The steering yoke assembly is analyzed for the Von-mises stress and total deformation for a torsional moment. Fig.9a shows the Von-mises stress is 94.349MPa and fig.9b indicates total deformation is 0.039321mm for the torsional moment of 38 Nm.

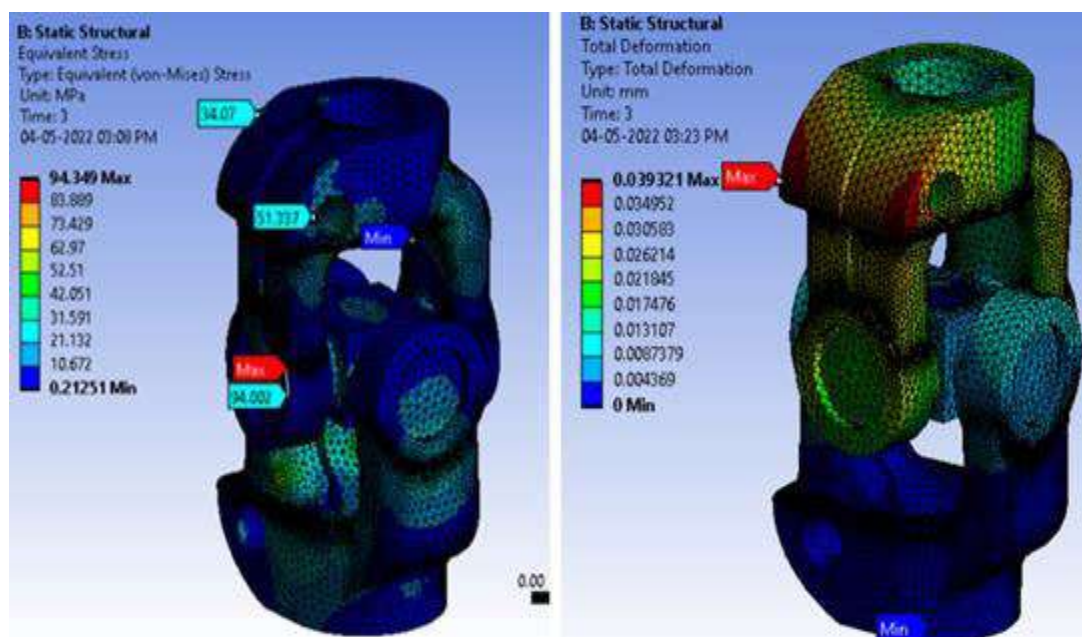
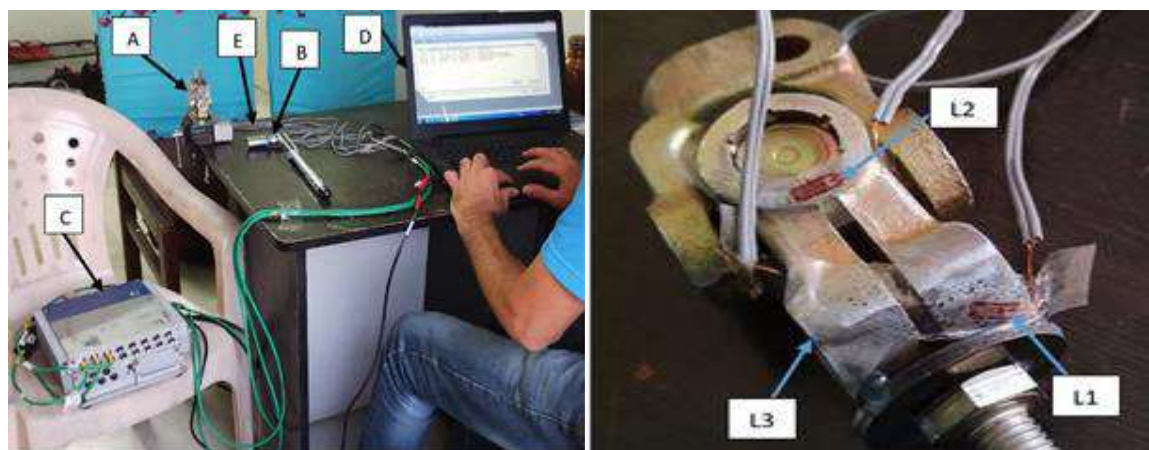


Fig.9 FEA Analysis of optimized universal joint

#### 5. EXPERIMENTAL TEST

By modifying the existing universal joint(A) experimental test carried out on it. For torque application a circular plate is welded to one side of yoke with bolt. To perform a test different equipment are used such as torque wrench(B), vice jaw, strain gauges(E), data acquisition system (C), and Display system(D). Strain gauges are located on 3 different positions on one side of yoke as shown in fig. The electric wiring connections are made with DAQ system, strain gauges and display system. The same boundary conditions are applied as used in a numerical analysis, one end of yoke is fixed in vice jaw and 38Nm twisting moment is applied on another end. The results are displayed on LED with the help of DAQ system and strain gauges.

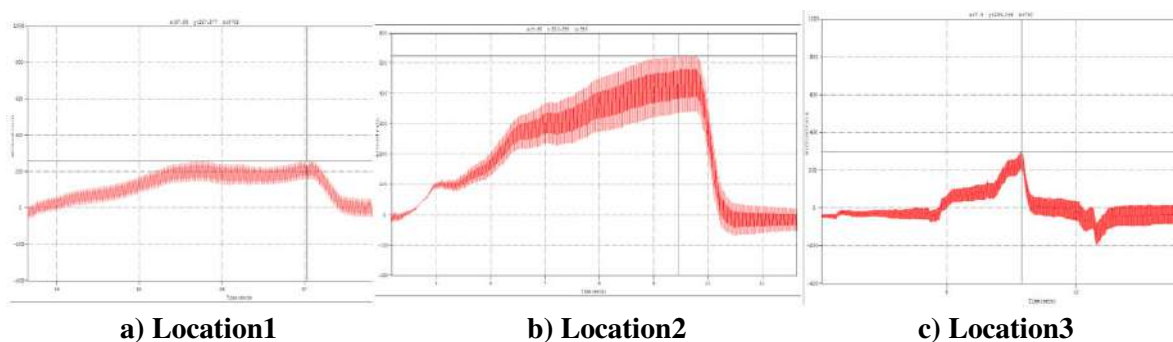


a) Experimental setup b) Strain gauges locating positions

Fig.10 Test setup for Physical Experimentation

### 6. RESULTS & DISCUSSION

By analyzing the results with the help of data acquisition system. Following graphs are plotted fig.11.



a) Location1 b) Location2 c) Location3

Fig.11 Strain vs time graph

Following table 4 shows the strain values at different locations on universal joint, which are noted by experimentation test with the help of strain gauges.

Table 4. Strain values by experimentation

Locations	Micro strain
Location 1	257.37
Location 2	523.85
Location 3	299.24

For stress calculation, the Hooke's law used.

$$E = \sigma / \epsilon$$

Following calculations for location 1.

$$205 \times 10^3 = \sigma / 257.377 \times 10^{-6}$$

$$\sigma = 52.7465 \text{ MPa}$$

Table 5. Variation of results

Locations	Stress (MPa)		% of variation
	Numerical Method	Experimental method	
Location 1	34.07	52.7465	35.41
Location 2	94.002	107.379	12.46
Location 3	51.337	61.336	16.31

The numerical results obtained from existing universal joint are compared with iterative universal joint geometry for geometry optimization. The stress values are calculated at 3 different points by numerical and experimental method. Table 5 shows the stress values by numerical and experimental approach. The variation of result at maximum stress point i.e. location 2 is 12.46%.

The modified yoke has less stress than that of existing yoke with reduction 8.35% mass. While comparing the existing yoke with the experimental result, though the stress reduction is not significant, mass reduction of 7.24% has been obtained.

**Table 6. Result analysis**

Parameters	Existing Yoke	Modified Yoke	Experimental Result
Von-Mises stress (MPa)	107.38	94.349	107.379
Deformation (mm)	0.0428	0.03932	-----
Mass (gm)	464.63	425.84	431

## 7. CONCLUSION

The stress analysis of universal joint assembly confines the maximum stress and deformation is expected to endure, without fatigue failure. Therefore, the universal joint investigated for a stress produced under torque conditions. Numbers of iterations are carried out in the analysis phase which gives the suitable values for design parameter. The result shows that

- 1) To improve performance, geometry has been modified using topology and free size optimization, which enables to reduce stress level marginally well below the yield limit.
- 2) The Grey Relational Analysis and TOPSIS method of optimization which has been given same result i.e., iteration 6.
- 3) A mass reduction for optimized yoke assembly is about 8.35% by numerical method and 7.24% by experimental method.
- 4) The stress levels are about 94.35 MPa by numerical method and 107.379 MPa by experimental method which is within a permissible yield limit of 415MPa. Therefore, Yoke is safe under given loading condition.

## REFERENCES

1. H. Bayrakceken, S. Tasgetiren, "Two cases of failure in the power transmission system on vehicles A universal joint yoke and a drive shaft", Engineering Failure Analysis 14 (2007) 716–724, ELSEVIER.
2. Vishal rathi, Prof. N. K. Mandavgad, "FEM analysis of universal joint of TATA 407", ICETET-09
3. Sunil Chaudhry, Anit Bansal & Gopal Krishan, "Finite Element Analysis and Weight Reduction of Universal Joint using CAE Tools", IJERT ISSN: 2278-0181, Vol. 3 Issue 10, October- 2014
4. Ananthu S Kumar,Rahul P John\_FEM Analysis of Universal Joint of Bharath Benz DE210BS4", IRJET, e-ISSN: 2395-0056, Volume: 06 Issue: 05 | May 2019
5. 5.Abhishek Mandal, Utkarsh Sharma static-structural-analysis-of-universal-joint-to-study-the-various-stresses-and-strains-developed", IRJET, ISSN: 2278-0181, Vol. 5 Issue 03, March-2016
6. Maram Venkata Sunil Reddy, C. Raghunatha Reddy, "Design and Analysis of Universal Coupling Joint", IJESC Volume 6 Issue No. 12, December 2016
7. Dhananjay S Kolekar, Abhay M. Kalje, Swapnil Kulkarni "Design, development and structural analysis of universal joint "by et al, IJAERS E-ISSN2249–8974
8. S.K.Chandole & M.D.Shende "structural analysis of steering yoke of an automobile for withstanding torsion/ shear loads", IJRET: International Journal of Research in Engineering and Technology eISSN: 2319-1163 | pISSN: 2321-7308
9. Farzad Vesali, Mohammad Ali Rezvani, "Dynamics of universal joints, its failures and some propositions for practically improving its performance and life expectancy" Journal of Mechanical Science and Technology 26 (8) (2012) 2439~2449
10. S.G.Solanke and A.S.Bharule, "An Investigation On Stress Distribution for Optimization of Yoke In Universal Joint Under Variable Torque Condition", Vol. 3, No. 2, April 2014 ISSN 2278 – 0149
11. Mr. P.G. Thate and Prof. D.S. Bajaj, "Review on Failure Analysis of yoke assembly of a transmission drive shaft subjected to Torsion and Shear" IJERT, ISSN: 2278-0181 Volume-2, Issue-10, October-2013.

## Quality Assessment of Commercially Available Indian Honey

Joe. Saajit Jeyan<sup>1</sup>, Ghadevaru Sarathchandra<sup>2</sup> and Periyar Selvam<sup>3</sup>

<sup>1,3</sup>Department of Food Process Engineering, SRM Institute of Science and Technology, Kattankulathur, Chengalpattu district, Tamil Nadu, India

<sup>2</sup>Pharmacovigilance Laboratory for Animal Feed and Food Safety, TANUVAS, Chennai - 600051, Tamil Nadu, India

### ABSTRACT

**Background:** Honey is an ancient dietary ingredient with several beneficial characteristics, including antifungal, antibacterial, digestive aid, and wound healing. As there is a rise in the need or demand for honey as the population grows, honey is subjected to various kinds of adulterations in order to meet that demand. Adults and children alike are susceptible to a variety of infections and disorders as a result of this adulteration. The main aim of this study is to evaluate the quality of a variety of commercially available Indian honey samples.

**Methods:** A comparative study was made between 4 different honey samples. The physicochemical properties (moisture, water activity, pH, colour), microbiological load (total plate count and yeast and mould), and antibiotic residue were performed.

**Results:** All four honey samples had a moisture content of 14-30% and a water activity of 0.5-0.61. Microbial load count for both bacteria and yeast and mould were below the detection limit in all four samples. The antibiotic residue was found to be negative in all four honey samples.

**Conclusion:** The overall study shows that all the selected honey samples were according to the safety standards and are considered safe.

Keywords: Adulteration, Antibiotic residue, HMF, Microbial Load, Physicochemical Parameters

### INTRODUCTION

Honey is a sweet, viscous fluid produced by the honeybee from plant nectar. Honey is the only sweetener that may be preserved and consumed in the same way that it is made in nature. Until recently, it was superseded by cane and beet sugar during the previous 100 years (Jonathan W.White.JR). Honey is becoming more popular as an antioxidant source due to its high content of phenolic acids and flavonoids, as well as other antioxidants such as glucose oxidase, catalase, ascorbic acid, carotenoid derivatives, organic acids, amino acids, and proteins (Khalil et al., 2010).

Raw honey has nootropic properties including memory enhancement, as well as neuropharmacological properties like anxiolytic, antinociceptive, anticonvulsant, and antidepressant properties. The polyphenol contents of honey, according to research, can quench biological reactive oxygen species and prevent oxidative stress while also replenishing the cellular antioxidant defense system (Mijanur Rahman et al., 2014).

It is deemed and proclaimed "adulterated" when cheaper and lower-grade elements are introduced to an original product, posing a health risk to the customer (Zaneta Bargan'ska et al., 2011). The addition of low-cost sugar, Corn syrup (CS), High fructose corn syrup (HFCS), Glucose syrup (GS), Sucrose syrup (SC), Inverted syrup (IS), High fructose inulin syrup (HFIS) in honey is a common method of adulteration.

Sugars can be utilized as adulterants in two different ways: direct adulteration and indirect adulteration. Direct adulteration involves adding a specific ratio of syrups to gathered honey to enhance its sweetness, whereas indirect adulteration involves overfeeding bees with sugar syrups to boost honey yield in hives. Other adulterants used in Ethiopian honey include water, bananas, wheat, and maize syrup or flour (Rafieh Fakhlaei et al., 2020).

Adulteration of honey can have a major impact on health such as an increase in blood sugar of diabetic patients as honey is an adulterer with sugars, increase in body weight and blood pressure of individual. It can also cause internal damage to organs which further leads to the formation of fatty liver and severe kidney injury (Rafieh Fakhlaei et al., 2020).

In this work, a complete analysis of different commercially available honey samples is done by utilizing standardized procedures to compare four distinct samples and investigate their adulterants.

---

## MATERIALS AND METHODS

### GENERAL SAMPLING:

Four different commercially available honey samples were procured from different market sources. These samples were indicated as A, B, C, and D. All the samples were collected in November and were stored in an airtight container to avoid contamination. Every chemical used in these experiments was of analytical grade.

### Physicochemical parameter testing:

#### MOISTURE:

The moisture content of all of these samples was determined using the refractive index approach, in which a few drops of samples were placed over the sample area of the refractometer, and scales were viewed through the eyepiece. The method was followed according to AOAC (2016).

#### WATER ACTIVITY:

Water activity (a<sub>w</sub>) was found by placing 1g of honey in the water activity meter (nova sina). The experiment was repeated thrice and the results were recorded (AOAC.,2016).

#### PH:

pH was noted using the pH meter. 10g of honey sample were mixed with 10 ml of distilled water. The experiment was repeated thrice and the results were recorded (AOAC.,2016).

#### MICROBIAL CONTAMINATION:

The contamination level in various honey samples was determined using the total plate count and yeast & mold method. The operation was carried out according to the AOAC (2016)

For microbial load determination, samples were extracted from commercially available honey samples and aseptically produced in sterile airtight containers. There were four main samples considered (Different brands were taken from the market). The total plate count (TPC) agar is placed into each petri dish with 1ml of food homogenate. The mixture was incubated for 24/48 hours at 35°C. Then the number of colonies was counted

#### ANTIBIOTIC RESIDUE:

Nutrient broth with pH indicator bromocresol purple was taken in a test tube, to each test tube the sample was added. Then, the test bacterium was pipetted into the test tube and mixed thoroughly. Later, the test tube was incubated at 37°C for 24-48 hours depending on the culture and its growth. The test tube that turned yellow after the incubation was noted as negative and those that remained purple were noted as positive for an antibiotic residue. The method was followed according to Kumar (2012).

#### Hydroxymethyl Furfural Determination:

This is a method used to determine the hydroxymethylfurfural or the HMF content present in honey. The given amount of honey was measured and added to the distilled water in the 50ml beaker. To this mixture then add carrez 1 and carrez 2 solutions. After mixing the solutions were filtered and 5ml of the filtrate was added to two different test tubes. To one test tube distilled water was added and to another 0.20% bisulfite solution was added. At last, absorbance was noted at 284nm and 336nm. This was done according to the Determination of Hydroxymethylfurfural (HMF) in Honey using the LAMBDA Spectrophotometer UV/Visible Spectroscopy by PerkinElmer.Inc.

#### SUGAR DETERMINATION:

This method was done to determine the total sugar, sucrose, fructose, glucose, and fructose-glucose ratio. All the methods were done according to AOAC (2016).

## RESULTS AND DISCUSSIONS

### MOISTURE:

Moisture content refers to how much water is present in your meals and materials. Moisture content was measured such that sample A (16%) showed the least moisture followed by sample B (19%) and sample C (20%). Sample D (24%) showed the highest moisture. Out of four samples three samples were within the required limit of FSSAI standards (<20%) and the other sample exceeds the limit. Moisture is reduced when the honey gets processed, lower the moisture of the honey sample implies that they are of good quality and capable of storing.

### WATER ACTIVITY:

Water activity describes how bacteria react to the water in your diet. The more the water activity, the faster bacteria, yeast, and mould can develop. The water activity of the honey samples was measured and their ranges

were sample A (0.520) followed by sample B (0.517), sample C (0.515), and sample D (0.602). The water activity of honey ranges from 0.50-0.65 according to Chiachung Chen (2019). Thus, all samples lie within the given range of water activity. These aw levels allow the honey to be classified as an intermediate moisture food, which means it may be stored for an acceptable amount of time.

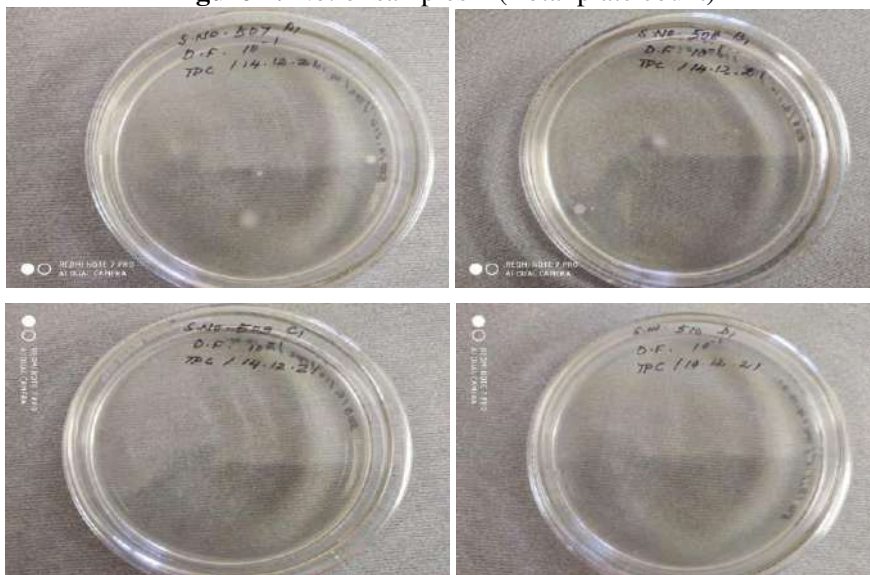
**PH:**

According to Techniques for the Evaluation of Microbiological Quality in Honey (2017), pH is used to measure the acidity level of honey; the permitted limit is between 3.5 and 5.5. The pH of sample A was 4.69 followed by sample B (4.64), sample C (4.79), and sample D (3.20). Honey's acidic pH is beneficial because it has been established that acidification promotes healing by encouraging oxygen release from hemoglobin. Honey has a pH that is low enough to hinder the growth of many bacterium species. This shows that pH is one of the major components that help in shelf-life extension and hinders the growth of microbes.

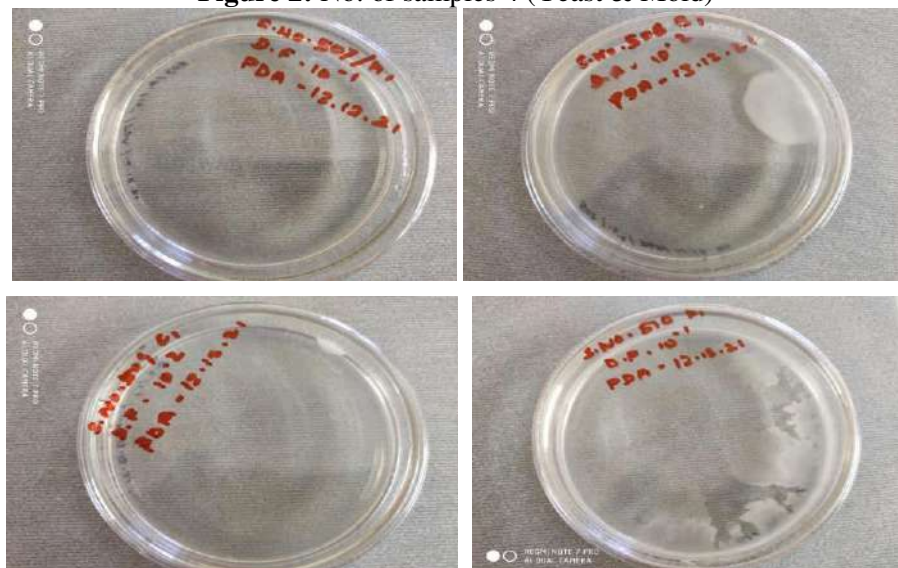
**MICROBIAL CONTAMINATION:**

The most common microbes discovered in honey are spore-forming bacteria and yeast. Clostridium botulinum, which causes baby botulism and a variety of illnesses, was discovered in some honey samples. To determine the presence of microbes, the total plate count approach is required. All of the samples had a total plate count below the detection limit, and the method's allowed limit is fewer than  $10^2$  cfu/100 g (Techniques for the Evaluation of Microbiological Quality in Honey.,2017). The detection limit for yeast and mould was similarly found to be below  $10^2$  cfu/100 g (Techniques for the Evaluation of Microbiological Quality in Honey.,2017).

**Figure 1: No. of samples 4 (Total plate count)**



**Figure 2: No. of samples 4 (Yeast & Mold)**

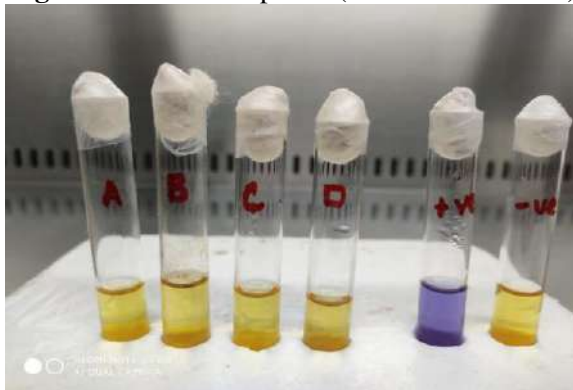




### ANTIBIOTIC RESIDUE

Honey is an important food commodity produced by honeybees. Honey containing antibiotic residue may degrade its quality and pose a health risk to humans. Beekeepers frequently use antibiotics to eradicate illnesses in honeybees. This test was done to determine the presence of both Enrofloxacin & Ciprofloxacin residues, in which all the samples showed negative results giving yellow color. This concludes that all the honey samples do not contain the antibiotic residues Enrofloxacin & ciprofloxacin. The maximum Residue Performance Level (MRPL) of Enrofloxacin & Ciprofloxacin is 10 µg/Kg.

**Figure 3:** No. of samples 4 (Antibiotic Residue)



### Hydroxymethyl Furfural Determination:

In this test, we were able to determine the hydroxymethylfurfural content present in honey. The highest amount of HMF content was found in the honey sample D (56.49mg/kg) and the lowest was found in sample C (9.94mg/kg), followed by sample B (12.44mg/kg) and then sample A (13.43mg/kg). The maximum limit of the HMF content as per FSSAI regulation is less than 80mg/kg. Even though sample D has the highest HMF content out of all, still all the samples fall under the limit of FSSAI regulation. HMF is one of the suitable indicators to determine the quality of honey, the higher the HMF content lower the quality of honey, and vice-versa.

### SUGAR DETERMINATION:

Total sugar in the commercial honey samples was determined and was found that sample A contains 81% followed by sample B with 82.6%, sample C containing 81.6%, and sample D containing 71.7%. With just the total sugar we can determine whether the honey is an adulterer with any sugar or not, as total sugar is the combination of natural sugar plus the added sugar and most processed honey has 70-80% of natural sugar.

Sucrose is one way we can tell whether the honey is adulterated with fructose or not. Higher the sucrose level that there is an adulteration of honey with fructose, sometimes it is because honeybees couldn't break down the sucrose molecule. The limit for sucrose in honey should be less than 5% according to FSSAI standard regulations. Sample D (4.08%) had the highest level of sucrose, followed by sample C (3.92%), sample A (3.85%), and sample B (3.1%). Overall, all the samples fall under the limit of FSSAI regulations.

Glucose% of sample A was found to be 38.5%, sample B was 40.8% followed by sample C which is 37.6%, and sample D with 36.21%. The results for fructose were sample A (42.35%), sample B (41.6%), sample C (43.66%) and sample D (35.48%). The range limit for the fructose to glucose as per FSSAI guidelines is 0.95-1.50 and the results were sample A (1.10), sample B (1.02), sample C (1.12), and sample D (0.98). All the samples for fructose to glucose ratio fall under the limit of FSSAI standard regulation. So, it is safe to say that there is no adulteration of fructose or glucose in the given samples of commercial honey.

### CONCLUSION

Four different commercially available honey samples were used to analyze the quality and its safety. All the parameters checked were in alliance with the required standards. In moisture content 25% of the samples were above the required limit as per FSSAI, this might lead to the growth of microbes. Overall, all four samples were found to be in accordance with the standards and can be termed safe. However continuous monitoring is required.

### REFERENCES

1. Monika Kędzierska-Matysek, Arkadiusz Matwijczuk, Mariusz Florek, Joanna Barłowska, Anna Wolanciuk, Alicja Matwijczuk, Edyta Chruściel, Radosław Walkowiak, Dariusz Karcz, and Bożena

- Gładyszewska. (2018). Application of FTIR spectroscopy for analysis of the quality of honey. *Contemporary Research Trends in Agricultural Engineering*.
2. Consuelo Pita-Calvo, María Esther Guerra-Rodriguez, Manuel Vazquez. (2017). A Review of the Analytical Methods used in the Quality Control of Honey. *Journal of Agricultural and Food Chemistry*.
  3. M. Zappala, B. Fallico, E. Arena, A. Verzera. (2005). Methods for the determination of HMF in honey: a comparison, *Food Control*, 16, 273–277.
  4. D. Anupama, K.K. Bhat, V.K. Sapna. (2003). Sensory and physico-chemical properties of commercial samples of honey. *Food Research International*, 36, 183–191.
  5. Blanka Zábrowská, Lenka Vorlová. (2014). Adulteration of honey and available methods for detection. *ACTA VET. BRNO*, 83, S85–S102
  6. Maria Lucia PIANA, Livia PERSANO ODDO, Antonio BENTABOL, Etienne BRUNEAU, Stefan BOGDANOV, Christine GUYOT DECLERCK. (2004). *Apidologie*, 35, S26–S37
  7. Official Methods of Analysis of AOAC International (2016). 16th Edition. Edited by Patricia Cuniff. Published by AOAC International. Virginia. USA. Test 17.2 .01.
  8. Rafieh Fakhlaei, Jinap Selamat, Alfi Khatib, Ahmad Faizal Abdull Razis, Rashidah Sukor, Syahida Ahmad, Arman Amani Babadi. (2020). The Toxic Impact of Honey Adulteration. *Foods*.
  9. Maria Josiane Sereia, Marcia Regina Ferreira Geraldo Perdoncini, Paulo Henrique Março, Rejane Stubs Parpinelli, Erica Gomes de Lima and Fernando Antônio Anjo. (2017). Techniques for the Evaluation of Microbiological Quality in Honey. *InTech*.
  10. M. I. Khalil, S. A. Sulaiman, L. Boukraa. (2010). Antioxidant Properties of Honey and Its Role in Preventing Health Disorder. *The Open Nutraceuticals Journal*, 3: 6-16.
  11. Najla A. Albaridi. (2019). Antibacterial Potency of Honey. *International Journal of Microbiology*.
  12. Mohammad Mijanur Rahman, Siew Hua Gan, and Md. Ibrahim Khalil. (2014). Neurological Effects of Honey: Current and Future Prospects. *Evidence-Based Complementary and Alternative Medicine*.
  13. Majdi Al-Mahasneh, Muhammad Al-U'datt, Taha Rababah, Mohamad Al-Widyan, Aseel Abu Kaeed, Ahmad Jobran Al-Mahasneh, and Nawaf Abu-Khalaf. (2021). Classification and Prediction of Bee Honey Indirect Adulteration Using Physiochemical Properties Coupled with K-Means Clustering and Simulated Annealing-Artificial Neural Networks (SA-ANNs). *Journal of Food Quality*.
  14. risteidis S. Tsagkaris, Georgios A. Koulis, Georgios P. Danezis, Ioannis Martakos, Marilena Dasenaki, Constantinos A. Georgiou and Nikolaos S. Thomaidis. (2021). Honey authenticity: analytical techniques, state of the art and challenges. *Royal Society of Chemistry*.
  15. Zaneta Bargan'ska, Marek S'lebioda, Jacek Namies'nik. (2011). Determination of antibiotic residues in honey. *Trends in Analytical Chemistry*. 1035-1047.
  16. Kumar VS. Residue profile of enrofloxacin and its primary metabolite ciprofloxacin in broiler chicken. (2012); *L15*: 1-72.
  17. V. Krishnasree, P. Mary Ukkuru. (2017). Quality Analysis of Bee Honeys. *International Journal of Current Microbiology and Applied Sciences*. 626-636.

---

---

## Cyber-Activism and Youth in India a Case Study of CAA Protest

Jenith Sekar and Kuldeep M. Siwach  
GD Goenka University, India

### ABSTRACT

After the advent of 2.0 technology, social media has permeated in all phase of life. During the time of Covid-19 and its subsequent lockdown, students and the professionals extensively used internet through smart phones and other devices. Social media platforms like Instagram, Snapchat, Facebook, Twitter etc. play a massive role in the lives of almost all who use internet. Among all of the social media, Twitter is considered as little more serious social media platform for initiating political and social discourse than other platforms. Activists, celebrities, political leaders, journalists and others have used Twitter for disseminating news and views to the large audience. Arab Spring in 2011, Tunisian revolution in 2010, I am 132 movement in Mexico in 2012, Umbrella Movement at Hong Kong in 2014, Sunflower Protest Movement at Taiwan in 2014 etc., were few of the protest movements which captured the attention of the entire world through Twitter. This research paper analyses the in-depth interviews of young frontline leaders during CAA Protest. In this paper, the tweets of Youth leaders and Youth wing portals during the time of CAA Protest have been manually collected, coded and analysed to understand their role in active political engagement on social media.

Keywords: Youth, Citizenship Amendment Act, Political Participation, Twitter Narratives, CAA Protest

### 1.0 INTRODUCTION

Twitter is a cyber-hub which propagates torrent of information to wide-ranging fragments of masses within fraction of seconds. Political parties, celebrities, business tycoons, activists, journalists and all sections of the common people mostly use Twitter as a strong weapon to organize and polarize a great number of people for social change. The Twitter revolution was seen as a new trend in human history. Twitter serves as a 'story changing and story evolving environment' which precipitates multiple interactions and discourses in online forums (Soedarsono & Mohamad, 2020). Arab Spring in 2011, Tunisian revolution in 2010, I am 132 movement in Mexico in 2012 (Sandoval Almazan, 2013), Umbrella Movement at Hong Kong in 2014 (Chan, 2014), Sunflower Protest Movement at Taiwan in 2014 (Basu, 2016) etc., were few of the protest movements which captured the attention of the entire world through Twitter. In consequence Social media platforms especially Twitter opened a new avenue of mobilizing people for political participation (Rodon et al., 2018). Proliferation of smartphones has intensified the use of these social media networks which in turn created a virtual space for all the citizens to communicate their opinion without any territorial restrictions.

### 1.2 YOUTH IN INDIA

India today is vibrant and young because of its youth population. The Indian youth constitute 22% of its population which is larger than the population of Pakistan (Bang, 2021). Out of these 261 million young people of India, 74% of them within the age group between 18-23 are currently not able to access higher education system and also not able to afford it (Today, 2021). In spite of the social and economic disparities, a handful of youth (0.8%) make themselves into higher educational institutions (Hazary, 1988). The most painful situation arises when these handful of youth are not able to get employment opportunities. A survey says that 33% educated youth in India are unemployed (Today, 2021). As these social and financial deprivation rattle the very psyche of youth, they become discontent. Extant studies have found out that youth are more likely to develop a sense of responsibility mainly because they are raised in a society which emphasis civic engagement (Fullam, 2016).

The Indian Telecom Services Performance Indicators states that in India as per the report from TRAI (Telecom Regulatory Authority of India) the total number of internet subscribers are 749.07 million at the end of June 2020 (TRAI, 2020). After the proliferation of internet, most of the Indian youths irrespective of being educated or uneducated use internet and social media for their studies, entertainments and for fostering relationship. Through these internet-supported gadgets, they have been as early as possible informed about the political events and are aware of politicised issues. After the arrival of social media, the very pattern of communication has changed from vertical to horizontal paradigm. This change of communication pattern paved way for the youngsters to express their political notions beyond structural and ideological constrains on the social media platforms.

### **1.3 Cyber-activism and Youth in India**

India has had a long history of student protests. Gandhi's ideology like non-cooperative movement made a huge impact on the mind of students and many were thus attracted towards him (Chandra, 1988). India witnessed a lot of student protest since freedom struggle movement. On August 12, 1936, The All India Student Federation (AISF) that was founded exclusively for the ulterior motive of Indian independence (Rayan, 2020). As history proceeded with technological progress, students changed their pattern of protest. In 1965 Tamilnadu faced a huge protest against a state introduced three language formula. Many students came to the streets and raised their voice against imposition of Hindi (HT, 2019). Student movements during the time of emergency (1975) was phenomenal in which more than 300 students were imprisoned (HT, 2019). Though there were many number of protests by students such as Assam Agitation (1979 to 1985), Anti-Mandal agitation in 1990, Anti-reservation protests in 2006, etc, they were mostly happening before the advent of Information Technology and Communication (ITC).

In 2011 there was a huge protest on the issue of corruption led by Anna Hazare, an activist from Ralegaon Siddhi (Singh, 2014). Anna Hazare's indefinite fast in Ramlila Maidan received unprecedented media and social media attention. Though there were nation-wide protest meetings, gatherings, sit-ins, the anti-corruption was accentuated by social media platforms, e-groups, blogs, etc. Most of the protesters were of students and young men of the megacities (Singh, 2014).

In December 2012, gang rape of a student in Delhi sparked off a large scale public protest against rape and sexual violence against women. Students from different universities and institutions such as Delhi University, Jawaharlal Nehru University (JNU), Guru Gobind Singh Indraprastha University, SNTD Women's University, Mumbai University, Tata Institute of Social Science, gathered at different junctions and started to protest through various forms like blocking roads and forming human chains (Singh, 2014). Social Media platforms like Twitter and Facebook acted as an entity with million tongues and thus condemned the heinous act. In February 2016, JNU students started an agitation against Rohith Vemula's suicide at University of Hyderabad.

In January 2017, students across Tamil Nadu protested against the central government for exempting Jallikattu from the prevention of Cruelty to Animals Act. They used Twitter, Facebook and other social media platforms to disseminate views and news with reference to Jallikattu (Ra, 2018).

Protests against the Citizenship Amendment Act (CAA) erupted in various parts of India when the Central government amended the act on 12<sup>th</sup> December, 2019. The students of Jamia Millia Islamia University on 15 December 2019 initiated the protest against the enactment of this Act and led a protest march from Jamia Metro to Parliament Street of New Delhi.

### **1.4 CAA Protest and Youth Participation**

#### **1.4.1 Background of CAA Protest**

The central government passed the Citizenship Amendment Act on 12<sup>th</sup> December, 2019 with 125 votes in favor and 105 votes against it (Ramesh, 2019). According to this act, until July 1987, it was sufficient for a person to be born in India to be eligible to get Indian Citizenship irrespective of caste, creed and religion. But the Citizenship Amendment Act, 2019 has amended the section 3, in sub-section (1), in clause (b) of The Citizenship Act, 1955 and inserted the provision wherein a person belonging to Hindu, Sikh, Buddhist, Jain, Parsi or Christian community from Afghanistan, Bangladesh or Pakistan, who entered into India on or before the 31st day of December, 2014 has been exempted by the Central Government to secure Indian Citizenship (Parashar, 2020). This Provision also restricts Muslim illegal migrants from Afghanistan, Bangladesh and Pakistan to become citizens of India and makes easier to the persecuted minority communities from the above mentioned neighbouring countries to get citizenship in India. This amendment also relaxes the requirement of naturalization from 12 years to 5 years (Vashishata, 2020). The critics reiterated that if Indian government grants citizenship status to illegal migrants based on religion then it will be considered as discriminatory, anti-constitutional and even against Assam Accord of 1985 (Basumatary, 2019). As the people of Muslim community and opposition political parties in India sensed that this stringent act deliberately corners and clampdowns their freedom and rights, they along with likeminded movements and organizations made their strong and robust contestation through various protests all over India.

#### **1.4.2 Cyber-activism and CAA Protest**

As a result of the Citizenship Amendment Act 2019, many student's organizations like Students Union (AASU), North East Students' Organization, All India Students' Association (AISA), The National Students' Union of India (NSUI), The Students' Federation of India (SFI), Akhil Bharatiya Vidyarthi Parishad (ABVP)

etc, protested against and for CAA not only on the streets but also on the virtual forums like Facebook, Twitter, and Instagram since 12<sup>th</sup> December 2019.

In order to show their resentment against CAA, the students of Jamia Millia Islamia University on 15 December 2019 initiated a protest against the enactment of Citizenship Amendment Act and led a protest march from Jamia Metro to Parliament Street of New Delhi. This protest march later exploded into a clash between policemen and the protesters (Wire, 2019). In spite of curfews and internet bans, the students of Aligarh Muslim University, Uttar Pradesh initiated various modes of protests both offline and online (Bhilwar, 2021).

There were number of incidents of clashes between police and students of various universities during the time of CAA Protests were reported and widely circulated on Social Media platforms. Multiple discussions and discourses on Twitter and other media forums with reference to CAA protest provoked and aggravated a nationwide protest. The CAA enthusiasts on the other hand protested in support of the Citizenship Amendment Act and generated counter narratives in different ways and possible means.

## **2.0 REVIEW OF LITERATURE**

There had always been number of political agitations and protests since the beginning of politics in humankind. After the introduction of Information and Communication Technology (ICT), the same humankind experienced a huge shift of political discussion and participation on the virtual milieu.

### **2.1 Cyber-activism and its Role**

Twitter plays a massive role in initiating and shaping public opinion. Even though youth lack political knowledge, Twitter offers them a chance to yell out their ideas and opinions on the virtual space and thus to reach out to a larger audience (Cotnam-Kappel, 2019).

Maesy Angelina (2011) articulates about a new kind of cyber-activism against sexual harassment called Blank Noise. In this article, the author describes how Blank Noise, an online activists forum engages itself with the virtual public through various virtual campaigns on sexual harassment against women.

Social media also generates emotional themes and motivational appeals so as to make people participate whether in online or offline protests. Some existing psychological models suggest that anger at perceived injustice, moral outrage, strong sense of group identification or shared interest, ideological factors, sense of deprivation and confidence that the movement is more likely to succeed are few of the emotional and motivational appeals which make the young to participate in protests (Jost, 2018).

Kuhu Sharma (2021) classifies cyber-activism in three different major forms. Digital advocacy, mobilisation and reactive activism. In advocacy activism, internet users disseminate and try to amplify news or views which are mostly unreported by the mainstream media. Cyber-activism is also effectively used and mis-used for mobilisation. A large number of people are mobilised for various reasons such as political protests, environmental campaigns and to have demonstration for various social issues. Reactive activism sometimes diverts the internet users towards anti-social activities mostly with malicious and destructive nature.

### **2.2 Cyber-activism and Youth**

Youth are most often accused of being apathetic towards politics and political activities, but recent studies refute this phenomenon. Without any doubt we could say that youth were little disappointed with the corrupt political parties and their commercialised politics which doesn't mean that your youth are less interested in politics. Though the youth were not so active in mainstream politics, we could have noticed that youth have never disengaged themselves from any social movement, protests, rallies etc. Today after the advent of social media, the political attitude and identity of youngsters have been thoroughly explored and widely expanded through social networks. The concept of "network individualism" (Loader, 2014) highlights how these young citizens are individually networked and shaped by different players through social media platforms. Through effective networking of the networked individuals, the young citizens more structurally and more systematically initiate online discourses and initiate civic engagement.

Checkoway & Gutierrez define political participation of the youth as youngsters participating in voting, campaigning, mobilising and integrating people for a common purpose (Margono, 2021). Ubiquitous technologies and internet significantly shape the lives of young. These digital natives act as new social actors who determine public opinion and focus issues related to everyday life in the network society (Angelina, 2011). To understand the online strategies and dynamics of youth Carrie James and Megan Cotnam-Kappe (2019) try to study the good and bad online political dialogues. This study also suggests new strategies for the youth to have civic engagement even more broadly.

We could see that modern youth in modern days irrespective of countries use various strategic digital mechanism to voice their political opinion. Muhammad Saud & Hendro Margono (2021) in their research paper highlight the rise of digital democracy in Indonesia. The authors illustrate how youth of Indonesia agitated against the new corruption law and how they used social media platforms to generate public opinion and multiple discourse on the same.

A study on 'Hashtag activism: social media and the #FreeYouth protests in Thailand' categorically enumerates the narrative pattern of the protest and its significant influencers. #freeyouth protest was successful as it relied not only on the online mode of protest but also was actively rooted on the physical space of universities, cities, etc. The author refers it as a hybrid movement (Sinpeng, 2021).

Students from South Africa led a huge campaign, 'The Rhodes Must Fall' at the University of Cape Town. The pivotal point of this campaign is demanding the removal of statue of British colonialist, Cecil John Rhodes. It also demanded for a reformation in the curriculum which promoted institutionalised racism in the University. In this article, 'Twitter activism and youth in South Africa: the case of #RhodesMustFall', Tanja Bosch (2016) argues that students used Twitter as the platform for political discussion and effective tool for shaping public opinion.

Weiyu Zhang (2011) in her article 'Redefining Youth Activism through Digital Technology in Singapore', explores how youth reshape the idea of civic engagement and how do they change the political landscape in Singapore.

### **3.0 RESEARCH OBJECTIVES**

1. To understand and analyse the role of young students and young student organizations on Twitter in facilitating CAA protest.
2. To understand major categories and formats of political narratives on Twitter during the time of CAA Protest.
3. To analyse the role of Twitter in facilitating protest and enabling digital discourse.

### **4.0 RESEARCH METHODOLOGY**

This research is a Qualitative study which entails Content analysis as a method to observe and to understand the role of Twitter in facilitating CAA protest. Johnny Saldaña's (2016) code scheme has been employed to classify and code the collected tweet corpus based on major themes and categories (Onwuegbuzie, 2016).

This paper attempted to analyse the tweets and in-depth interview transcriptions of Youth Leaders and Youth Organizations in shaping and facilitating a predefined online discourse through easy-to-use digital architecture, Twitter with reference to CAA Protest.

This research also managed to conduct in-depth interviews with the student leaders and young frontline workers who actively participated in the protests during the time between 01.12.2019 and 29.02.2020. Various formats of Twitter resources such as texts only, texts with links, texts with photos and texts with videos are also identified during the process of data acquisition.

Manual and computer-assisted qualitative data analysis software (CAQDAS) have been used to collect, code and categorize a data set of 5107 tweets from both verified and non-verified accounts. MAXQAD, a Qualitative Content Analysis Software is used to code the collected data, to analyze the tweets and to categorize the tweets of young student leaders and their organizations.

### **5.0 Content Analysis of Youth Participation on Twitter Narratives**

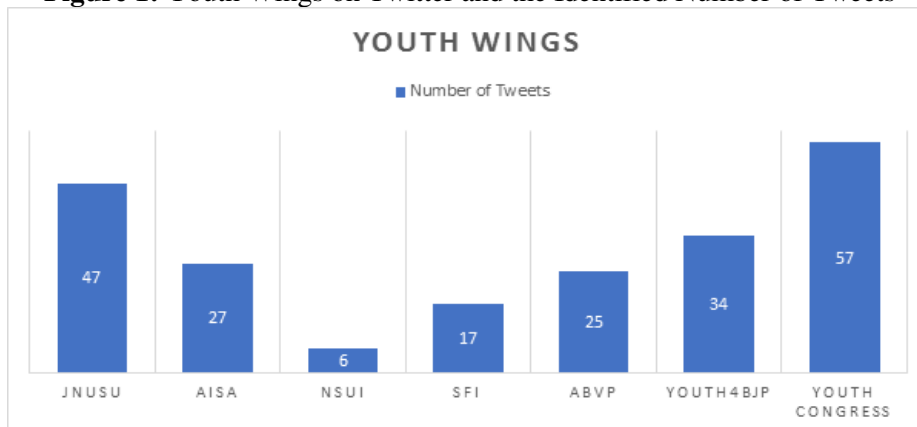
Youth and Students so far have felt a sense of alienation and isolation from the mainstream political participation due to various factors and precarious circumstances. But the recent trends and technical feasibilities build a cyber space for the youth and students to participate in political debates and to initiate public opinion. The recent phenomenal involvement of youth and students in politics through social media has erased the stains of stigmatization of young people with an image of apathy, consumerism, and anomie (Clua, 2018). Twitter has opened a new window and maximized the opportunity for youth and Students to actively participate in political discourses as political actors. This article focuses on the content analysis of tweets of youth organization and young key players as political actors on Twitter and their role in CAA protest in India.

#### **5.1 Identifying Youth Political Organizations on Twitter**

A data corpus of 5107 tweets have been retrieved with the reference of key hashtags such as #CAAProtest, #CAA\_NRC\_NPR, #ShaheenBagh, #DelhiViolence, #IndiaSupportsCAA, #IndiaDoesntSupportCAA etc, on

Twitter during the time between 01.12.2019 and 29.02.2020. Most of the identified Youth Political Organisations use Twitter to share photos or videos of political activities, to give counter reply to the criticisms, to make people understand the true side of the story, to appeal the government and the people, to condemn or support a particular act, to facilitate a political narratives based on the current situations and events.

**Figure 1: Youth Wings on Twitter and the Identified Number of Tweets**

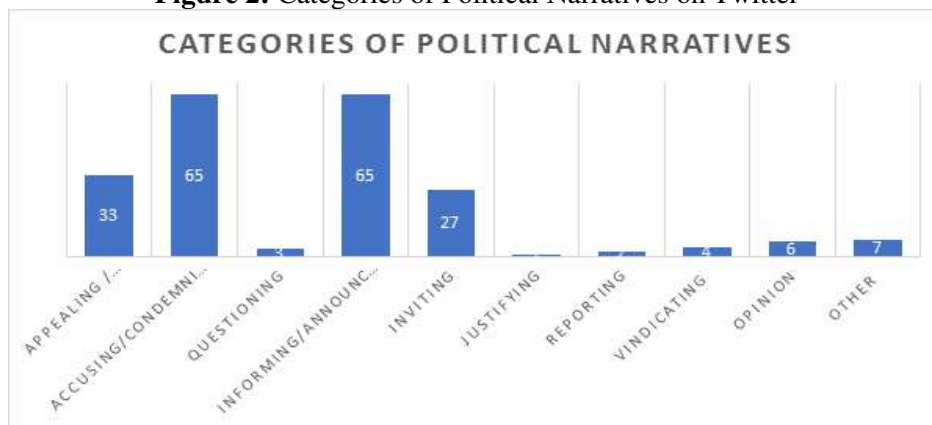


As can be seen from figure 1, it has been identified that Youth Congress has generated 57 tweets with reference to CAA Protest. Jawaharlal Nehru Students Union (JNUSU) stands next to Youth Congress with 47 tweets. Youth4BJP, a youth political wing of Bhartiya Janata Party (BJP) tweeted 34 times. Some of the other youth political wings like All India Students' Association (AISA), a left wing student organisation in India with 27 tweets, Akhil Bharatiya Vidyarthi Parishad (ABVP) with 25 tweets, Students' Federation of India (SFI) with 17 and The National Students' Union of India (NSUI) and the student wing of the Indian National Congress (NSUI) with 6 tweets stand in the front row to generate more tweets with reference to CAA protest in India during the time between 01.12.2019 and 29.02.2020.

### 5.2 Analyzing Major Categories of Political Narratives by Youth Organizations

After analysing the data set of 5107 tweets between 1<sup>st</sup> December 2019 and 29<sup>th</sup> February 2020 on Twitter with reference to CAA protest, we could identify tweets generated by major youth wings. These tweets of the major youth wings facilitated multiple online interactions and many offline protests. Appealing to the students, condemning the political actors and their activities, protesting against and for the implementation of CAA, blaming the political party leaders for instigating protest, announcing certain happenings to the youth members and justifying the act or to justify decision of the government are few of the identified major categories of tweets which facilitated political narratives on Twitter.

**Figure 2: Categories of Political Narratives on Twitter**



Most of the youth organizations use Twitter as an effective tool to disseminate information and to announce about the recent updates to the organizations' members in particular and to the large audience in general. Coding and analyzing 5107 tweets help us to expound major categories of political narratives on Twitter generated by major youth organizations during the time between 01.12.2019 and 29.02.2020. As can be seen from figure 2, we could find that youth organisations used most of the tweets for informing the public and for accusing the political parties. For example, @ABVPVoice posted a tweet accusing the political parties like AAP, Congress and AIMIM, "It is heart wrenching that in order to destroy the social fabric & spirit of

harmony prevalent in the society the leaders of political parties like AAP, Congress, AIMIM along with the Urban Maoists have poisoned the minds of common people of the city with their false propaganda.” Similarly, @JNUSUofficial with a strong sense of contempt tweeted, “Draconian and colonial laws are being used to witchhunt Muslims, activists and to curb dissent.” Few of the tweets were also spawned to inform about the happenings and the event updates with reference to CAA Protest. For example, @SFI\_CEC informed to their comrades about an event organized and the subsequent arrests and lathi-charge excised by the police, “SFI today at 6pm burnt down effigy of Assam CM Sarbananda Sonowal and Himanta Biswa Sarma protesting against CAB. While the programme was going on Police lathi-charged the protesters while arrested 7 comrades including the State President Kashap Choudhury.” Other Tweets revolve around the categories of Twitter narratives like appealing and inviting.

### 5.3 Analyzing the Role of Youth in Facilitating Political Narratives on Twitter

From the recent and extant studies, it is observed that Twitter plays a vital role in facilitating and shaping public opinion through multiple political narratives. Being more interactive and more instant, Twitter assists students and youth activists to embark on the journey of initiating and facilitating multiple digital discourses and discussions in order to create substantial political narratives. After having analyzed the data of 374 tweets of key youth activists from the corpus of 5107 tweets on CAA Protest between 1<sup>st</sup> December 2019 to 29<sup>th</sup> February 2020, it is suggested that Political narratives of these young key players on Twitter have played a vital role in facilitating various online discourses.

Figure 3: Number of Tweets by Young Frontline Leaders

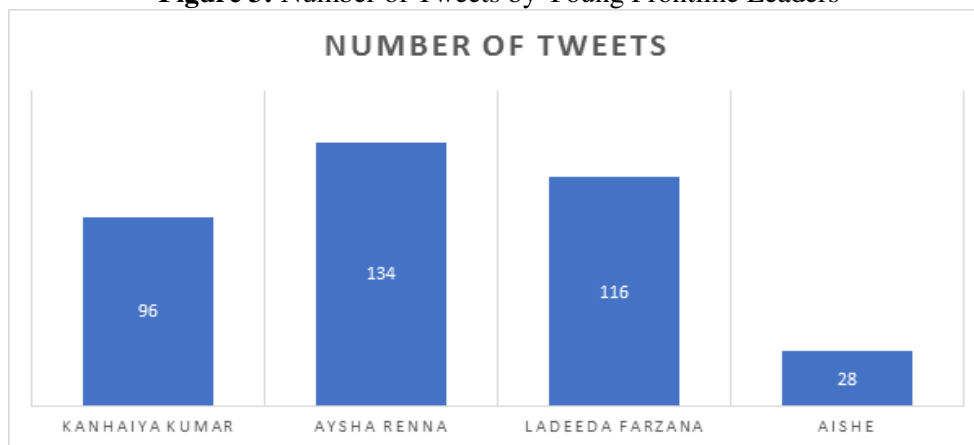
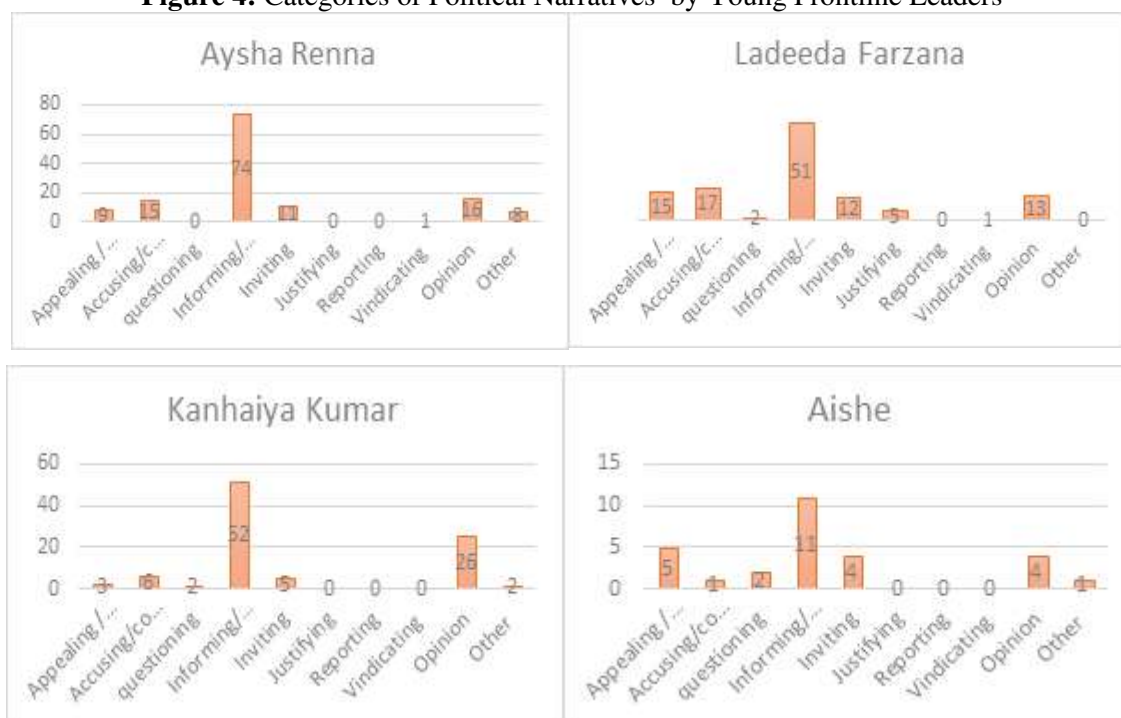


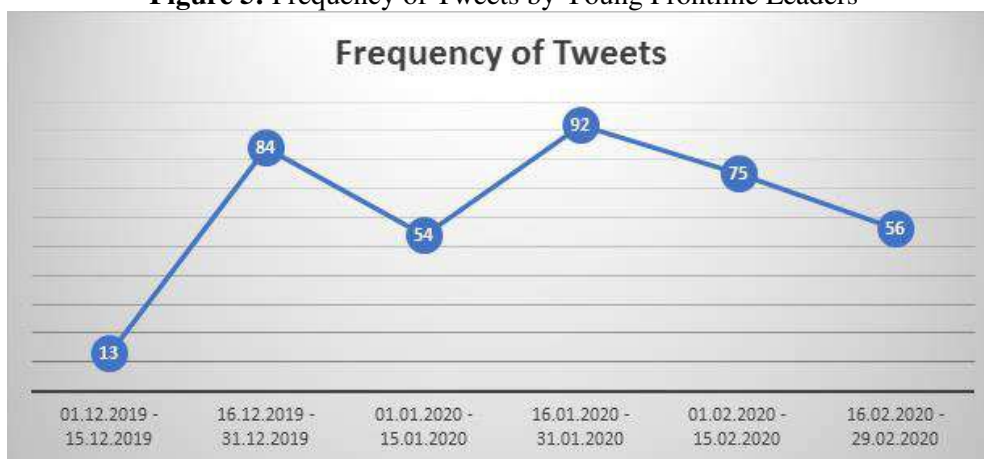
Figure 4: Categories of Political Narratives by Young Frontline Leaders





Political narratives carefully tailored by the above-mentioned young players could initiate online discourse and eventually offline protest. As can be seen from figure 3 & 4, the graphs highlight the number of tweets engendered by the youth activists with reference to CAA Protests. Aysha Renna, a student activist from Jamia Milia Islamia University, tweeted 134 times almost all are related to CAA Protest. Most of those tweets are used to inform about her protest activities. Ladeeda Farzana, another student activist of the same University generated 116 tweets with reference to CAA Protest. Most of her tweets also revolve around 'informing' about her protest activities. Kanhiya Kumar, a former student activist, stands with 96 tweets out of which most of them are used to inform and to express his opinion on CAA. Aishe, the present student leader of JNU has generated most of her tweets on 'informing' and few of them to appeal for media attention and for rescue during the time of violence.

Figure 5: Frequency of Tweets by Young Frontline Leaders



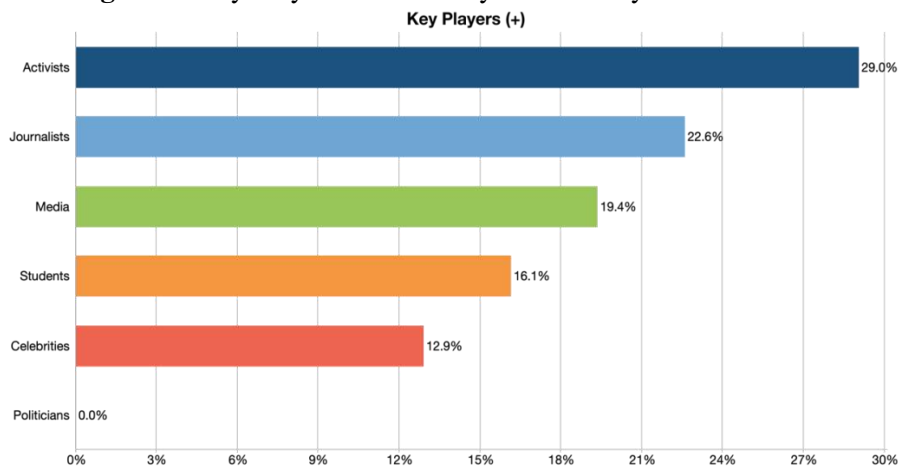
Protests against the Citizenship Amendment Act (CAA) erupted in various parts of India when the Central government amended the act on 12<sup>th</sup> December, 2019. From then on there were various online and offline protests that had been initiated both in support and against CAA. The above figure 5, suggests that there was a high rate of political tweets posted by these above-mentioned young student activists with reference to CAA protest especially during the time period between 16.12.2019 to 31.12.2019 and 16.01.2020 to 31.01.2020. It is observed as of figure 5 that the first hike in the graph is because of series of protest activities since 15<sup>th</sup> December when clashes broke between Delhi police and Jamia University students which consequently resulted casualties on both the sides (Chothar, 2020). More reactions on Twitter are felt between these time frames was not only due to protest activities in Delhi alone but also due to various instances of arrests and deaths ensued especially in Uttar Pradesh and in several parts of the country in December 2019. The second hike in the graph between 16.01.2020 to 31.01.2020 is observed due to various protest activities across the country. Some of the protest activities like candle procession from Jamia University to Shaheen Bagh, a juvenile opened fire at a protest at the Jamia Millia Islamia, injuring one student, etc. happened during these time durations which eventually resulted to multiple online discourses on Twitter. And we can be certain that Youth Organizations and Students Twitter presence played a major role in facilitating political narratives and shaping public behavior in offline protest.

#### 5.4 Analyzing Youth Participation in CAA Protest

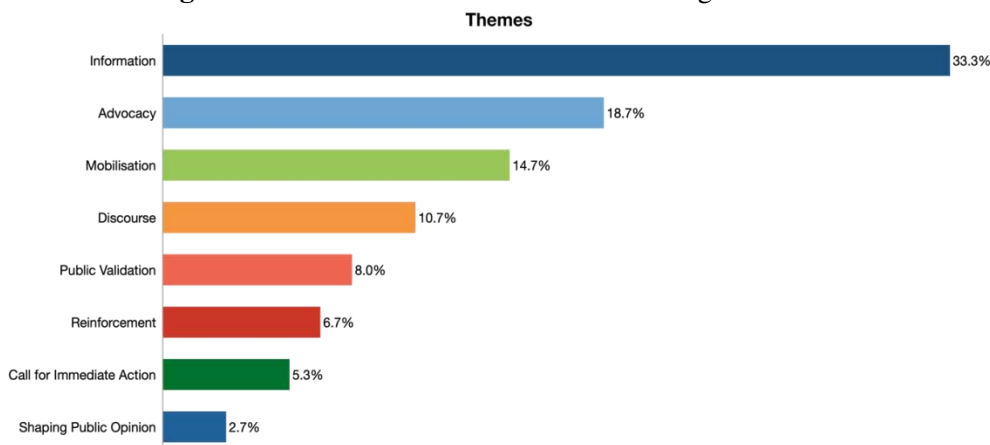
Extant studies state that in the modern era especially after the proliferation of internet, Youth and their participation in politics impacted a lot world-wide. Arab Spring in 2011, Tunisian revolution in 2010, I am 132 movement in Mexico in 2012 (Sandoval Almazan, 2013), Umbrella Movement at Hong Kong in 2014 (Chan, 2014), Sunflower Protest Movement at Taiwan in 2014 (Basu, 2016), Fees Must Fall movement (#FMF) which began in South Africa in mid-October 2015 (Bosch, 2016), Jallikattu Movement in Tamilnadu in the year 2017 (Sathak, 2018), etc., are few of the examples of Youth engagements in Politics which got accelerated through various social media platforms. CAA Protest has a significant outlook as it had been pioneered and propagated by Youth. Young activists under the banner of Naga Students' Federation (NSF) from North East first started the protest though the objective was different. Subsequently Jamia Milia Islamia College Students from New Delhi and Aligarh Muslim University from Uttar Pradesh took it to the next level (Bhilwar, 2021).

In-depth interviews conducted with frontline student leaders and students of different Universities, mostly from Jamila Milia Islamia University give a broad picture of the entire narratives and substantiate the research questions.

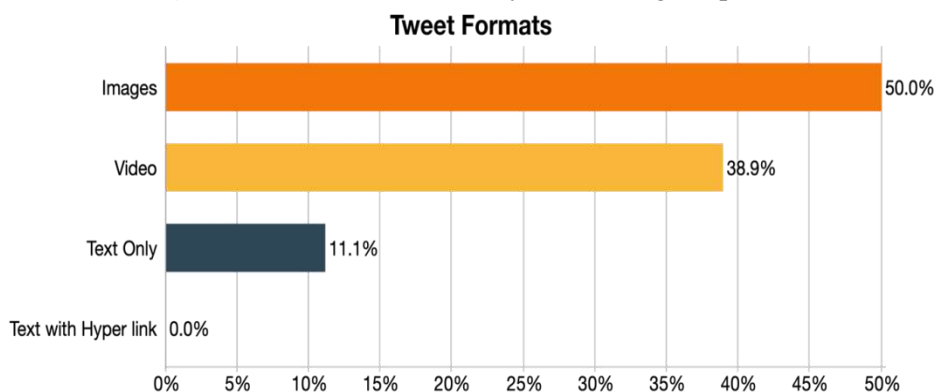
**Figure 6:** Key Players who directly or indirectly influenced Youth



**Figure 7:** Prominent Themes on Twitter during the Protest



**Figure 8:** Tweet formats widely used during the protest



In-depth interviews conducted with frontline student leaders and students of different Universities in Delhi with reference to CAA Protest exemplify Youth Participation in CAA Protest. The transcription of the in-depth interviews is coded and categorized based on the Johnny Saldaña's (2016) code scheme. MAXQAD, a Qualitative Content Analysis Software is used to code the entire transcription of the in-depth interviews.

As of figure 6, it is observed that most of the students said that they were closely following activists and journalists for credible information. One of the student activists said, “*women in Shaheenbagh influenced me, many students of Jamia influenced me*”. Few of the students also acknowledged that they rely upon independent news portals and journalists on Twitter for credible news sources.

As of figure 7, most of the student activists used Twitter for disseminating the happenings instantly to their companions in particular and audience at large in general. One of the students said, “*Twitter provided a lot of live information that where to organize, where to gather. So whatever is happening and so what's the present status there?*” Transcripts show students use Twitter mostly to share pieces of information, to get public

validation and for mobilisation. One of the Jamia student activists said, “*I was detained, nobody was with me and, I thought it was an end-game for me, but then when I was released, I was trending on Twitter, so I think maybe it helped me. You will get minimum justice that you have to get. So even in that way to access justice, we asked for public validation.*”

As of figure 8, as the transcripts are coded, it is observed that young activists get influenced by images and videos rather than the other formats such as text only and text with hyper link.

Twitter not only enables interactions with one another but this cyber-space has been recognised by activists, journalists, politicians, celebrities etc., to generate public opinion through multiple micro narratives. A rapidly expanding body of researches have substantiated that there has been significant correlation between Twitter narratives and political participation of youth. It is also observed in studies that underrepresented groups of youth use social media for building their identity and reinforcing their existential consideration (Brough, 2019). In order to express themselves, to amplify their voice and to draw public validation, youth use an important tool on twitter called Hashtags (Literat, 2019). Thus Twitter narratives serve as a legitimate force for the student and young activists to construct new opinions and meticulously express their ideological construct on certain issues through hashtags. Twitter narratives constructed by youth around the CAA protest have impacted the public to a great extent. #IndiaSupportsCAA, #IndiaDoesNotSupportCAA, #DelhiRiots, #ShaheenBaghProtest, #ISupportDelhiPolice, #CAA, #HindusAgainstCAA, #CaaProtests, #NRC\_CAA\_NRR, #DelhiViolence, #NoToNPR\_NRC\_CAA, etc., were few of the trending threads which generated political narratives through various interactions and connections on Twitter during the CAA protest.

Most of the frontline student leaders opined that all the credits cannot be attributed to Twitter alone. And they also acknowledged that Twitter has been used as an effective tool to amplify the unheard feeble voices. It is also observed in the in-depth interview that Twitter had an influential factor in certain groups and certain parts of society and not as a whole. Twitter helped the frontline youth leaders to connect to people at large and to update with. Apart from these, it is said that the protest was a complete inorganic and spontaneous one.

## 6.0 FINDINGS AND DISCUSSION

1. This content analysis on the data set of 5107 tweets reiterates that Youth Congress, as a political wing, generated more Twitter feeds pertaining to CAA Protest than other major youth wings like JNUSU, YOUTH4BJP, ABVP and AISA in the time period between 1<sup>st</sup> December 2019 and 29<sup>th</sup> February 2020.

1. Among Kanhaiya Kumar, Aysha Renna, Aishe and Ladeeda Farzana, Aysa Renna posted more tweets than other key student leaders in generating CAA narratives during the time period between 1<sup>st</sup> December 2019 and 29<sup>th</sup> February 2020.

3. It is observed that though all the above-mentioned student frontline leaders and political student wings construct their narratives around CAA protest, their content and intent differ according to their agenda setting priorities on Twitter.

4. The important categories of Twitter narratives based on themes like Appealing, Condemning, Protesting, Accusing, Announcing and Justifying are identified. It is observed that tweets containing the sense of information and accusing were more generated and accelerated through Twitter. Kanhaiya Kumar, Aysha Renna, Aishe and Ladeeda Farzana used most of their tweets to inform on what was happening with reference to the CAA protest. It could be recent development regarding protest, informing about the arrest, informing about participating in a protest, informing about meeting with the leaders etc.,

5. It is also surprising to observe that CAA protest is substantiated by both offline and online activism, one initiating and influencing the other.

## 7.0 CONCLUSION

The presence of Youth and Student Wings on Twitter is substantial and more effective. As Twitter has 280 characters capacity, retweet, mention, sharing ability, its source and contents are more consumed and circulated. It is very obvious to note that a few student leaders and student wings pedantically advocate selective magnifications of issues and thus facilitate political narratives on Twitter.

Analyzing and identifying the tweets of the frontline youth leaders and student wings, it is postulated that the categories of Twitter narratives, the frequency of the tweets during the time of protest certainly create and shape public opinion through multi-level online discourses. The initial point of protest is offline and spontaneous but later gets intensified by online discourses. It can be equated to a spring getting expanded and extended, a

snowball getting rolled and simultaneously becoming bigger and bigger . It can be called as dialectical hybrid mode of protest.

Analyzing the Twitter narratives of cyber-activists, political leaders, mainstream media, journalists, web-portals and celebrities in CAA Protest would be another possible and further area of study.

#### **BIBLIOGRAPHY**

1. Sandoval Almazan, R. (2013). Cyberactivism through Social Media: Twitter, YouTube, and the Mexican Political Movement "I'm Number 132". 46th Hawaii International Conference on System Sciences (pp. 1704-1713). Hawaii: IEEE.
2. Chan, C.-p. (2014). The Hong Kong Umbrella Movement: A Students' or a People's Movement? *E-International Relations* , 1-3.
3. Basu, P. (2016). Social Media and Social Movement. *Media Watch*, 226-243.
4. Nagarwal, N. (2019, December). The Poisonous Law: The Citizenship Amendment Act 2019. Retrieved from Research Gate: [https://www.researchgate.net/publication/337948797\\_The\\_Poisonous\\_Law\\_The\\_Citizenship\\_Amendment\\_Act\\_2019/link/5df79d85299bf10bc35f4654/download](https://www.researchgate.net/publication/337948797_The_Poisonous_Law_The_Citizenship_Amendment_Act_2019/link/5df79d85299bf10bc35f4654/download)
5. Fullam, J. (2016). Becoming a youth activist in the internet age: a case study on social media activism and identity development. *International Journal of Qualitative Studies in Education*, 1-18.
6. Shivakumar, G. (2013, April 17). India is set to become the youngest country by 2020. Retrieved from The Hindu: <https://www.thehindu.com/news/national/india-is-set-to-become-the-youngest-country-by-2020/article4624347.ece>
7. Today, I. (2021, September 18). Survey reveals 33% educated youth are unemployed due to lack of future skills: Study. Retrieved from India today: <https://www.indiatoday.in/education-today/latest-studies/story/survey-reveals-33-educated-youth-are-unemployed-due-to-lack-of-future-skills-study-1854292-2021-09-18>
8. Bang, A. (2021, January 11). A roadmap for the young. Retrieved from The Indian Express: <https://indianexpress.com/article/opinion/columns/india-youth-world-leader-soft-skills-jobs-7142263/>
9. Hazary, S. C. (1988). Protest Politics of Student Youth in India. *The Indian Journal of Political Science*, 105-120.
10. TRAI. (2020, November 9). The Indian Telecom Services Performance Indicators. Retrieved from [www.trai.gov.in](http://www.trai.gov.in)
11. Singh, R. (2014). *New Citizen's Activism in India: Moments, Movements and Mobilisation*. New Delhi: Centre for Democracy and Social Action (CDSA) .
12. Rayan, A. P. (2020, February 8). Student activism is not a dirty word. Retrieved from The Hindu: <https://www.thehindu.com/education/student-activism-is-not-a-dirty-word/article30769537.ece>
13. Ra, S. (2018). Social Media and Peoples Movement: A view on Role of Social Media in Jallikattu Protest. *Research Journal of Humanities and Social Sciences* , 131 - 134.
14. HT. (2019, December 18). A brief history of student protests in India. Retrieved from Hindustan Times: <https://www.hindustantimes.com/india-news/a-brief-history-of-student-protests-in-india/story-zYvk2GebUUVBtzjOzcLA1N.html>
15. Margono, M. S. (2021). Indonesia's rise in digital democracy and youth's political participation. *Journal of Information Technology & Politics*, 1 - 12.
16. Cotnam-Kappel, C. J. (2019). Doubtful dialogue: how youth navigate the draw (and drawbacks) of online political dialogue. *Learning, Media and Technology*, 1 - 22.
17. Angelina, M. (2011). Digital Natives' Alternative Approach to Social Change. In P. P. Nishant Shah, *Digital Activism in Asia Reader* (pp. 37 - 53). United Kingdom: Meson Press.
18. Jost, J. T. (2018). How Social Media Facilitates Political Protest: Information, Motivation, and Social Networks .*Advances in Political Psychology*, 85 - 118.

19. Chandra, S. (1988). Protest Politics of Student Youth in India. *The Indian Journal of Political Science*, 105-120.
20. Sinpeng, A. (2021). Hashtag activism: social media and the #FreeYouth protests in Thailand. *Critical Asian Studies*, 1 - 15.
21. Loader, B. D. (2014). The networked young citizen: social media, political participation and civic engagement. *Information, Communication & Society*, 143–150.
22. Ramesh, S. (2019, December 18). Citizenship Amendment Act: What is it? Retrieved from Careeranna: <https://www.careeranna.com/articles/citizenship-amendment-act/>
23. Parashar, S. (2020). CAA (CITIZENSHIP AMENDMENT ACT 2019): BANE OR BOON? *International Journal of Creative Research Thoughts* , 3811 - 3816.
24. Basumatary, N. K. (2019). Importance Of Citizenship Amendment Bill: A Study. *International Journal of Scientific Research*, 1-3.
25. Wire, T. (2019, December 15). Jamia Violence: Delhi Police Internal Probe Reveals 3 Bullets Were Fired, Says Report. Retrieved from The Wire: <https://thewire.in/government/jamia-millia-islamia-caa-protest-police-firing>
26. Vashishata, G. (2020). Citizenship Amendment Act: Digital Activism On Twitter; A Corpus-Based Textual Analysis Of Tweets On CAA. *Journal of Content, Community & Communication*, 1 - 14.
27. Bhilwar, A. (2021). Social Media and Protest: A Case Study on Anti CAA Protest in India. 3rd International Conference on Advanced Research in Social Sciences (pp. 1 - 15). London: Oxford.
28. Onwuegbuzie, A. J. (2016). Mapping Saldaña’s Coding Methods onto the Literature Review Process. *Journal of Educational Issues*, 130 - 150.
29. Clua, A. (2018). Youth impact in the public sphere: The dissolution of the Spanish Youth Council in the press and on Twitter. *Comunicar*, 49 - 57.
30. Chothar, G. J. (2020). Anti CAA Protest – The Machination. *International Journal of Law Management & Humanities*, 1 - 6.
31. Bosch, T. (2016). Twitter activism and youth in South Africa: the case of #RhodesMustFall. *Information, Communication & Society*, 1 - 13.
32. Sathak, M. (2018). Social Media and Peoples Movement: A view on Role of Social Media in Jallikattu Protest. *Research Journal of Humanities and Social Sciences* , 131 - 134.
33. Bhilwar, A. (2021). Social Media and Protest: A Case Study on Anti CAA Protest in India. 3rd International Conference of Advance Research in Social Science (pp. 11 - 25). Oxford United Kingdom: icarss.
34. Brough, I. L. (2019). From Ethical to Equitable Social Media Technologies: Amplifying Underrepresented Youth Voices in Digital Technology Design. *Journal of Media Ethics Exploring Questions of Media Morality*, 1 - 15.
35. Literat, I. (2019). Youth collective political expression on social media: The role of affordances and memetic dimensions for voicing political views. *Sage*, 1 - 22.
36. Service, I. A. (2019, December 31). #IndiaDoesNotSupportCAA takes Twitter by storm. Retrieved from Hindustan Times: <https://www.hindustantimes.com/india-news/indiadoesnotsupportcaa-takes-twitter-by-storm/story-SwRmAoj4tEh2DY9OUK0mBJ.html>

## **A Study on Out-Of-The-Class Training As Perceived By Students of Arts and Science Colleges in Krishnagiri District**

**I. Aruljothi<sup>1</sup> and R. Prabhu<sup>2</sup>**

<sup>1</sup>Periyar University, Salem, Tamil Nadu, India

<sup>2</sup>Department of BBA, Govt. Arts College for Men, Krishnagiri, Tamil Nadu, India

### **ABSTRACT**

The student training of effect on training beyond the class room is studied. The demographics profile of the student is analyzed. The multilinear regression equation is defined for students beyond classroom and what is the effect of your level of agree ability towards your skills observed from the training the students in Krishnagiri District.

Keywords: Class, college, Krishnagiri, training, student

### **1. INTRODUCTION**

Student perception is examined from a data practice system and the segments of this design are associated with instructional marvels. Exploration on understudy discernment about different highlights of study hall being is assessed. Two primary highlights are task need, containing instructor conduct and instructional exercises, and homeroom association. It is done that review on understudies' intellectual intercession of homeroom activities is a use expansion to investigate on teaching.

Learning Outside the Classroom (LOtC) is the use of spots staying than the classroom for learning and instructing. It is tied in with having understudies and youngsters all over town, giving them with energizing, testing and different encounters to help them learn. Learning outside the classroom is an instrument for learning and educating and which has been checked to expand accomplishment and achievement, create conduct and improve the commitment of entire gatherings of students, including the individuals who are difficult to hold inside the classroom climate (Dyment, J et.al 2014).

The 'places' where learning happens can have a significant outcome on how understudies take on with a subject or plan. Learning outside the classroom can happen at practically anytime and anyplace - outside or inside: in the school grounds, on the high road, in historical centers, in the nearby park and craftsmanship exhibitions, on peaks and streams or somewhere else in the worldwide. As an important method of learning it ought not be limited to the late spring or as 'add-on' next assessments. Understudies accept that youngsters ought to approach successive, constant and reformist encounters in the school grounds, instructive visits likewise away from home and private, and that these encounters ought to be utilized as an apparatus for learning, educating and conveying the educational plan across each subject spots.

Learning past the classroom ought to make into getting ready for all students, consistently and all the all year. It is a persuasive device that is affirmed to increment passionate, reinforce social, achievement and individual create and adds to the wellbeing and prosperity of understudies and youngsters.

### **2. WHY TO TAKE LEARNING OUTSIDE THE CLASSROOM**

It may be challenging to remain understudies on classroom assignments. Particularly as the school year draws to a close and the weather outside is lovely, and everything they

What you need to do is behave as if you're devastated. Bring math outside and have children estimate how stretched out they would need to be to sprint, leap, and skip across a field. Understudies can discuss it outside and diagram it once they return to the classroom.

By extending learning beyond the classroom, students discover new opportunities to make concepts more accessible and genuine by putting them into a more practical context. Numerous concepts that appear to be too difficult to grasp in the classroom become much more perceptible in the vast expanding universe when they are contextualised and when children are more busy and motivated to know and learn. Taking students beyond the classroom is analogous to unclipping their section. Surprisingly, their personalities are permitted to explore and frequently conclude with a few incredibly original outcomes regardless of the subject being taught.

When students are upbeat and focused, they learn more. It's astounding how much an understudy can learn simply by playing. Testing is additionally an incredible method for learning; youthful understudies gain an enormous amount of knowledge about volume and surfaces through simple activities like sand and water play,

while more seasoned children will appreciate acting as nature educators and criminologists about smaller than expected monsters and their current situation. Prepared to incorporate outdoor play and visits into educational programmes, as well as to attract and encourage children to learn, will inevitably locate that more motivated to attend school (Wan Idros Wan Sulaiman et.al, 2011).

While studying outside the classroom undoubtedly entails implementing a completely different code of conduct than the executives require, it can frequently result in a general improvement in behaviour as a result of understudies being persuaded, joyful, and locked in. There are quite a few understudies who will almost certainly set up if the result is that the complete class must return to learning maths inside. One of the main benefits of studying outside is that you have the most incredibly well-stocked stock cupboard you could imagine, with a good portion of it open. Regardless of how tight a school's financial plan is, anyone with a decent creative mind will have the capacity to improve free, substantial learning opportunities for students who will remain.

### 3. LITERATURE OF REVIEW

According to Parker (2012), the process of training new PhDs is difficult and results in large dropout rates due to the student's, mentor's, and program's financial and time inputs. One strategy for improving graduate education is to make apparent the abilities that students must acquire and to establish mechanisms for acquiring those skills.

In this chapter, Sluijsmans et al.(2002) offer two research that address the following questions: 1) How trustworthy are peer ratings in problem-based learning groups? 2) Do raters employ unique strategies? and 3) How do students feel about problem-based learning? peer review? The first study had 27 university students enrolled in a fourth-year course in educational sciences that utilised problem-based learning. The second study enrolled 51 fourth-year students at a Primary Teacher Training College who were likewise exposed to problem-based learning. While generalizability tests demonstrate that peer assessments are valid in one of the two experiments, evaluation questionnaire data indicate that students feel extremely uneasy when forced to give negative judgments without prior instruction.

According to S.Ravi et al. (2016), "Training" is an all-encompassing phrase that is frequently used to describe changes in our behaviours as a result of an experience we have had at some time in our life. Typically, we refer to this as training. "Training" was defined as the act, process, or method by which one trains, the skill, knowledge, or experience acquired by one who trains, and the state of being trained, and the term "experience" was defined as direct observation or participation in events as a basis for knowledge, the fact or state of being affected by or gaining knowledge through direct observation or participation, practical knowledge, skill, or practice derived from direct observation of or participation in events.

### 4. OBJECTIVE

- To study the training available to the students beyond classroom.
- To evaluate the development of skills through training and its effect among the students.
- To identify the role of importance of the training beyond classroom of the students in the study area.

### 5. METHODOLOGY

#### SOURCES OF DATA

The essential information needed for the examination were gathered by controlling a survey to the undergrads who are concentrating in Government just as Self-Financing Arts and Science Colleges in Krishnagiri District, the investigation was led during the time frame between June 2018 and November 2018.

#### DATA ANALYSIS TOOLS

The gathered information put away in the format of csv file format, it tends to be utilized for information investigation. Linear regression is used for testing the factors.

### 6. ANALYSIS AND INTERPRETATION

**Table 6.1:** Gender of the Respondent

Gender	No of Respondents	Percentage
Male	434	58.10%
Female	313	41.90%

The table 6.1 shows that 58.1% of the respondent are male and 41.9% of the respondent is Female. Male respondent is mostly respond the study.

**Table 6.2:** Age of the Respondent

Age	No of Respondents	Percentage
18	177	23.69
19	193	25.84
20	169	22.62
21	141	18.88
>21	67	8.97

The table 6.2 shows that 25.84% of the respondent age group were 19, 23.69% of the respondent age group were 18, 22.62% of the respondent age group were 20, 18.88% of the respondent age group were 21 and 8.97% of the respondent age group were above 21. The most of the respondent answered the questionnaires for age group of 19.

## 7 MULTIPLE LINEAR REGRESSION

Multiple Linear Regression (MLR) method helps in establishing correlation between the independent and dependent variables (Jobson J.D,1991).

The Main Question of the Effect on Training Section in the question is What is the effect of your level of agree ability towards your skills observed from the training beyond classroom?

$$y_i = \beta_0 + \beta_1 x_{i1} + \beta_2 x_{i2} + \dots + \beta_p x_{ip} + \epsilon$$

where, for  $i = n$  observations:

$y_i$  = dependent variable

$x_i$  = explanatory variables

$\beta_0$  = y-intercept (constant term)

$\beta_p$  = slope coefficients for each explanatory variable

$\epsilon$  = the model's error term (also known as the residuals)

**Table 7.1** shows the Multilinear Regression coefficient results

What is the effect of your level of agree ability towards your skills observed from the training	Y-Intercept	College Location	Gender	Age	Father Occupation	Family Type	Family Size	Transport
I can cooperate and work in a group/team	2.43	-0.0056	0.5659	0.0165	0.1094	0.5633	0.1735	0.0438
I get along with people around me	2.46	0.0509	0.5226	0.0143	0.009	0.6919	0.2267	0.0405
I feel responsible for my actions	2.54	0.2234	0.2029	-0.0494	0.263	0.4406	0.1478	0.0803
I believe in dividing the work among group/team members	2.75	0.0875	0.5205	0.0858	0.2604	0.2244	0.1188	0.0831
I understand myself	2.62	0.2017	0.4915	0.0051	0.1551	0.4403	0.0939	0.0544
I feel comfortable teaching others	2.71	0.139	0.519	-0.014	0.1775	0.4778	0.1298	0.0693
I consider all choices before making a decision	2.91	0.1911	0.4938	-0.0101	0.1524	0.5911	0.1467	0.0654
I listen carefully to opinions of group/team members	2.33	0.0694	0.2967	0.1281	0.1236	0.3524	0.2924	0.0048



I am respected by others my age	2.46	0.1568	0.3017	0.085	0.1696	0.1558	0.2551	0.0871
I can lead a discussion	2.41	0.1326	0.4473	-0.0682	0.1171	0.4934	0.1354	0.1263
I use past experiences in making decisions	2.69	0.1723	0.3014	0.0712	0.1007	0.4977	0.262	0.0563
I believe that all group/team members are responsible persons	2.72	0.1709	0.3342	0.0339	0.0972	0.426	0.3014	0.1248

Table 7.1 shows that the P value of Year\_ Studying and Father\_Occupation have the highP value because of the Multicollinearity. To solve the Multicollinearity problem by using data standardization.

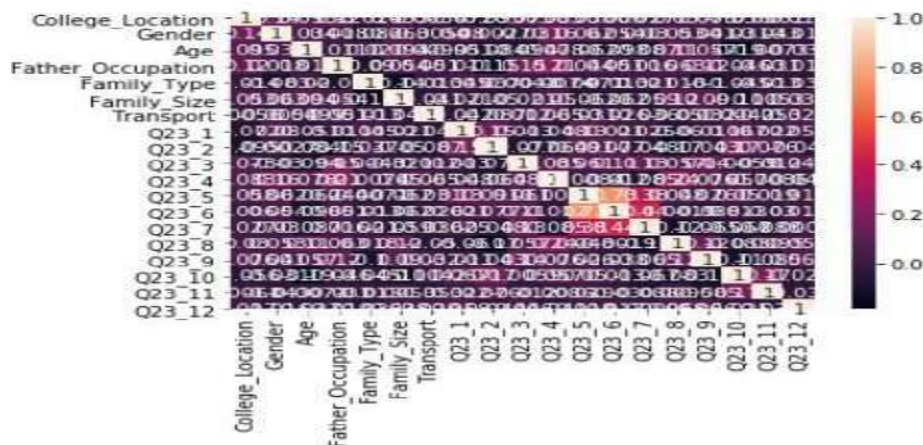


Figure 1: Correlation Based Heat Map

The Figure 1 shows that correlation based Heat Map, majority of the correlation value is between 0 to 0.6.

**8. FINDINGS**

- 58.1% of the respondent are male
- 25.84% of the respondent age group were 19
- Multilinear Regression Equations of what is the effect of your level of agree ability towards your skills observed from the training beyond classroom. It is showed in table7.1.

**9. CONCLUSION**

The student training of effect on training beyond the class room is studied. The demographics profile of the student is analyzed. The multilinear regression equation is defined for students beyond classroom and what is the effect of your level of agree ability towards your skills observed from the training the students in Krishnagiri District.

**REFERENCE**

1. Dymont, J., & Dray, S. (2014). Learning outside the classroom: Theory and guidelines for practice. Journal of Experiential Education, 37(4), 429–430. <https://doi.org/10.1177/1053825914555600>
2. Jobson J.D. (1991) Multiple Linear Regression. In: Applied Multivariate Data Analysis. Springer Texts in Statistics. Springer, New York, NY. [https://doi.org/10.1007/978-1-4612-0955-3\\_4](https://doi.org/10.1007/978-1-4612-0955-3_4)
3. Parker R. (2012). Skill development in graduate education. Molecular cell, 46(4), 377– 381. <https://doi.org/10.1016/j.molcel.2012.05.003>
4. S, Ravi & Er.D.Gajendran,. (2016). A Study On Training & Development Needs of MBA Students In Krishnagiri District. Shanlax International Journal of Management. Volume: 3. 94.
5. Sluijsmans, Dominique. (2002). Student Involvement in Assessment. The Training of Peer Assessment Skills.
6. Wan Idros Wan Sulaiman, Maizatul Haizan Mahbob & Arina Anis Azlan, Learning Outside The Classroom: Effects on Student Concentration and Interest, Procedia - Social and Behavioral Sciences, Volume 18, 2011, Pages 12-17, ISSN 1877-0428, <https://doi.org/10.1016/j.sbspro.2011.05.003>.

## Enhancing Ready-To-Eat Lentils by Retort Packaging Method

Preethi Jasmine J<sup>1</sup> and Ghadevaru Sarathchandra<sup>2</sup>

<sup>1</sup>Department of Food Process Engineering, SRM Institute of Science and Technology, Kattankulathur, Chengalpattu district, Tamil Nadu, India

<sup>2</sup>Pharmacovigilance Laboratory for Animal Feed and Food Safety, TANUVAS, Chennai, India

Orcid Id- <https://orcid.org/0000-0003-4941-4602>

### ABSTRACT

Lentils (Rajma, Chana, Black Chana, Lobia) as it is rich in B vitamins, iron, magnesium, potassium and zinc they are the key sources in Human diet. Due to high demand, the Lentils were optimized for Ready-to-eat product using by Compact thermoforming packaging machines and retort processing. This study aims to extend the shelf life of the lentils and by checking the parameters such as physicochemical properties moisture and water activity, most of the samples showed below 50% of moisture and around 0.8-0.9 water activity. There was no microbial load in all 4 samples for Yeast and mould, salmonella, E.coli and coliform after Retort processing. Mycotoxins were also tested using High performance Thin Layer chromatography. These test shows the absence of microbial growth and water retention reveals that the product shelf life. Hence the Quality and shelf life of the product were analysed and the results were compiled.

Keywords: Lentils, Mycotoxin, Microbial Load, Physicochemical Parameters, Polypropylene.

### INTRODUCTION

The key sources in human diet are lentils (Rajma, Chana, Black Chana, Lobia) as it is rich in B vitamins, iron, magnesium, potassium and zinc. They're also a great source of plant-based protein and fiber; there are various kinds of lentils that are used. They are classified among soft-coated lentils that require shorter cooking time, and thus have smaller losses in nutrients as compared to those with hard seed coat (Mo'ez Al-Islam Ezzat Faris, Hamed Rabah Takruri and Ala Yousef Issa, 2012).

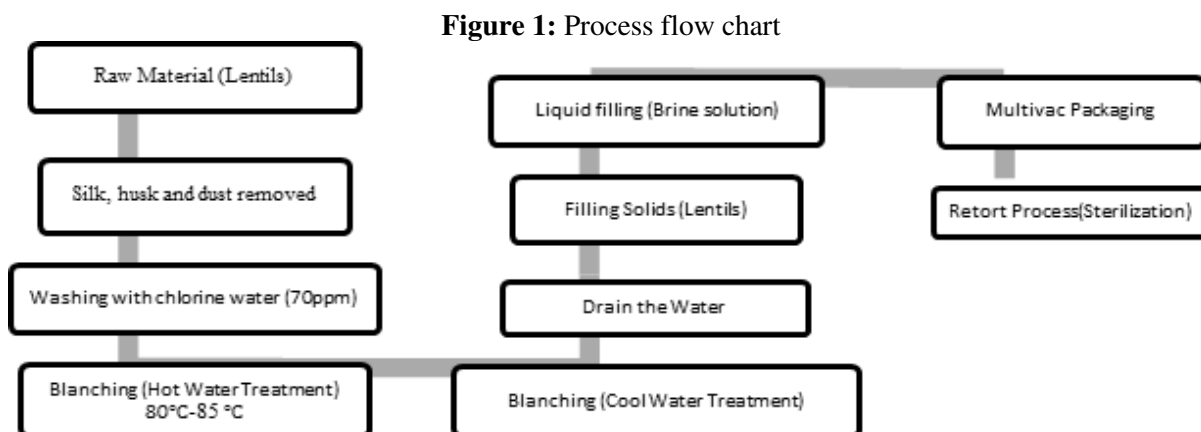
Lentils (*Lens culinaris* Medik) are the most ancient cultivated crops among the legumes. These are a good source of protein in a vegetarian diet because they contain roughly 20-30% protein, which is nearly 2.0-2.5 times more than cereals (Vijay sharma and Vandana Shukla, 2014). Lentils supply significant pertaining to food and mental wellness benefits, and are popular to reduce various non-communicable ailment to a degree colon cancer and cardiovascular ailments (Yude, et al., 1993; Jukanti, et al., 2012). The protein deficiency can be solved by consuming grain legumes. The lack of interest in the production of lentils among farmers is due to the flaws faced in most of the existing varieties (Alma Zhumabaevna Saikenova, and Mukhtar Sarsenbekovich Kudaibergenov, 2021). There are various pesticides were they especially attack in food industry before it reaches the consumers: fungus and insects are the main cause for food spoilage in warehouses.

By consumption of contaminated food it leads to serious health issues and they are also susceptible for mycotoxins and aflatoxins (Jakic-Dimic et al., 2009). Polypropylene is a clear film which can resist high temperature with high strength and puncture resistance. It is a good barrier to air, pest control and high barrier water vapour, which is not affected by the humidity changes (Hirsch, 1991). Nowadays consumers are cautious about their health and they prefer more nutritious foods and they are ready to pay a higher price for better quality products. PP is characterized as a good high thermal expansion, chemical resistance, high tensile strength and operate at the temperature 121°C.

### MATERIALS AND METHODS

#### SAMPLING

Commercially available four samples of Lentils (Chana, Rajma, Black Chana and Lobia) were taken and processed (fig 1) to facilitate the better enhancement of shelf life by retort packaging. Multivac machine is a **Compact thermoforming packaging machines** their primary function is to protect the product against outside influences. The model which was used was R255 enables high-quality shrink packs in medium-sized pouches.



## PHYSICOCHEMICAL PARAMETER TESTING

### MOISTURE

Moisture content in all these samples were tested using the standard proximate testing procedure were samples were weighed accurately and added in 4 different dishes and at different time intervals the weight was noted along with initial weight and final weight. Experiment was done in triplicates and values were noted.

### WATER ACTIVITY

Water activity is noted in a water activity meter. Experiment was done in duplicates and values were noted.

### MICROBIAL LOAD

Total plate count (TPC), Yeast and Mold and Coliform count were measured to determine the contamination level in lentils (Fig 2). The procedure was followed as per AOAC standard protocol. The media used for TPC- Total plate count agar, Yeast and Mold- Chloramphenicol Yeast glucose agar and Coliform-Violet Red Bile Agar (VRBA). *Escherichia coli* (E.coli) count was measured, the Pre enrichment media used was buffered peptone water and selective enrichment media was Macconkey agar and Eosin methylene blue. The streak plate method was followed. The Salmonella count was measured, the Pre enrichment media used was buffered peptone water and selective enrichment media was Brilliant green agar (BGA) and Deoxycholate Citrate Agar (DCA). The streak plate method was followed. Media preparation as shown in Fig 2. The procedure for these five test was followed as per AOAC standard protocol (2016).

**Figure 2: Lentils Sampling and Media Preparation**



## Estimation of Mycotoxin using High Performance thin layer chromatography (HPTLC)

### Estimation of Multimycotoxin

Sample analysis was done by taking a known amount (25g) of grinded sample in a flask of 250ml, 4g of sodium chloride was added and treated with acidified acetonitrile of 100ml. Then in an orbital shaker at 200rpm for 30mins the mixture was shaken. Then through whatsmann paper (No1) it was filtered. In a 250ml separating funnel to a 50ml filtrate, the 50ml of distilled water and hexane was added. Shake gently for 3 mins and the water phase: acetonitrile was collected and this process performed twice. To the final water phase 20ml of chloroform was added in another separating funnel and then it is shaken vigorously. Through anhydrous sodium sulphate bed in a vial the chloroform was collected. In a hot plate the extract was evaporated and then the dried extract finally was reconstituted with acetonitrile and used for HPTLC spotting (Ramesh *et.al.*, 2013).

### Retort Packaging Method

Retort pouches are flexible plastic pouches which are packed with already cooked or semi-cooked food, sealed and subsequently sterilised to create food pouches that have a shelf life of up to 18 months with no preservatives

and zero refrigeration. Retort Pouches were invented by the US Army for storing military rations in the 1970s and have since revolutionized food and beverage packaging in the Ready-to-Eat packaged food segment. The lentils are sent on the conveyor's for blanching is a short time period in which water is heated to a temperature 80-85°C for about 10mins. Additive mixing- salt, sugar and water is used as a mild brine solution as a preservative. Filling the solid (Lentils) material in pouch and weigh the solid material. Filling- Liquid (brine solution) maintaining the temperature above 50-60°C. Sealing of the pouch (band sealing). Retort Tray loading and heat the water 121.5°C for about 30 mins. Unloading the retort tray (Virat abishek, Kumar.R, 2014).

## RESULTS AND DISCUSSION

### Moisture and Water Activity measurement

Water activity ( $a_w$ ) and moisture content are different parameters. Water activity explains how the water in the food react with microorganisms but Moisture content defines the amount of water in food and ingredients. The higher the moisture content, faster in the microbial growth like Yeast and mold, Salmonella, bacteria and coliform will be able to grow- resulting in the spoilage of food and their standards of food storage. Moisture content of 4 samples (Chana, Rajma, Black Chana and Lobia) was 0.4 – 0.6%. Water activity for samples (fig 3) was 0.876, 0.879, 0.873 and 0.876 was detected at a temperature between 28.4-29.0. Moisture content will retain in the product for some extent but due to retort packaging the contamination and the microbial growth is prevented. FSSAI standards have set a permissible level of not more than 14%. Hence it is concluded that the moisture and water activity of all the 4 samples are within the limits. The procedures for physicochemical parameter testing was followed as per the protocol mentioned in the food safety standards authority of India Lab Manual 10.

Figure 3: Samples for Water activity



### MICROBIAL LOAD

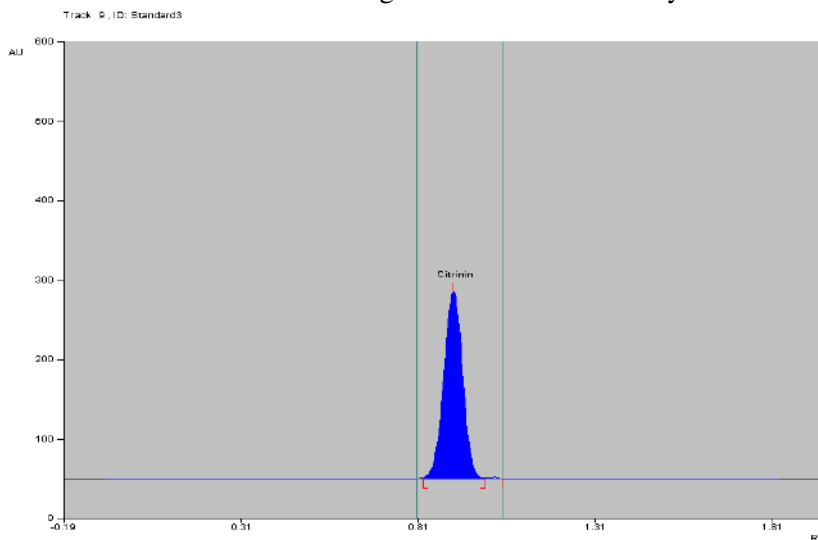
Purpose behind determining the microbial load is to verify there is no microbial load after retort packaging since the lentils are predominantly found under soil level. So, that it extends the shelf life of the product. The test was conducted for raw lentils and finished product. TNTC- Too numerous to count. Cfug – Colony forming unit per gram. In estimation of Yeast and mould it was found that there was no growth both in Raw & finished product. Total Plate Count (TPC) test was carried out to determine the bacterial load in Raw material (Rajma, Chana, Black Chana and Lobia) and in finished product to assess the shelf life of the product. It was found that in raw materials 20- 25 (cfu/g) colonies were in rajma, chana and numerous count for black chana and lobia. In finished product no colonies were found due to retort processing. Coliform test was done to determine the bacterial load in Raw material (Rajma, Chana, Black Chana and Lobia) and in finished product to assess the shelf life of the product. It was found that in raw materials no colonies were found except in Chana and during retort processing the colonies were absent in finished product Chana. *Escherichia coli* (E.coli) test performed to determine the presence of E.Coli in 25gms it was found to be present in raw materials and absent in finished product to assess the shelf life of the product. *Salmonella* test is to determine the presence of Salmonella in 25gms it was found to be present in raw materials and absent in finished product to assess the shelf life of the product. As per World Health Organization (WHO) norms permissible limit for microbial load of processed food is below 10000 (cfu/g) of TPC. Since the microbial load is less than the permissible limit it proves that it extends the shelf life of the finished product by retort packaging method.

### ESTIMATION OF MYCOTOXIN

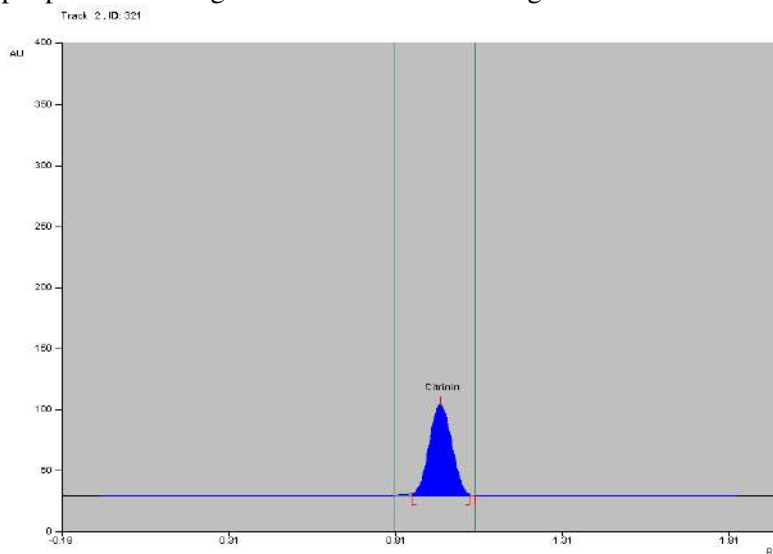
Toxins such as Aflatoxin B1, B2, G1 and G2 were tested along with Citrinin, Ochratoxin A and T2 toxin was also tested, among in which the third sample of Rajma, Black chana and Lobia showed the presence of T2 toxin in Rajma (68 µg/kg) and Lobia (99 µg/kg), Citrinin in Black chana (81 µg/kg) and Lobia (59 µg/kg). Based on the Fssai regulations Aflatoxin must not be present in the concentrations higher than 5 µg/kg in lentils. When

brine solution of 5ml was added there was no presence of toxins. Since Aflatoxin is absent it extends the shelf life in all the three samples of finished product by retort packaging method. The presence of Multimycotoxin is represented as graph below (fig 4- fig 7).

**Figure 4** Citrinin Standard Peak in High Performance Thin Layer Chromatography

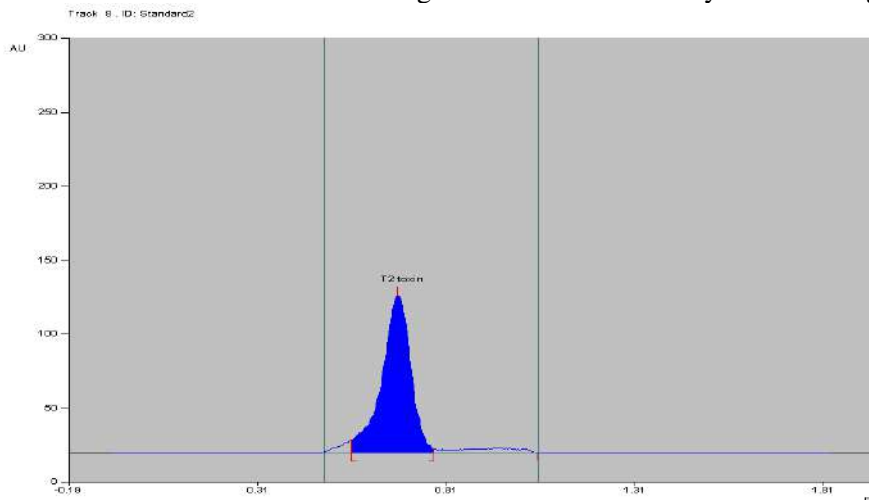


**Figure 5** Positive sample peak indicating Presence of citrinin in High Performance Thin Layer Chromatography

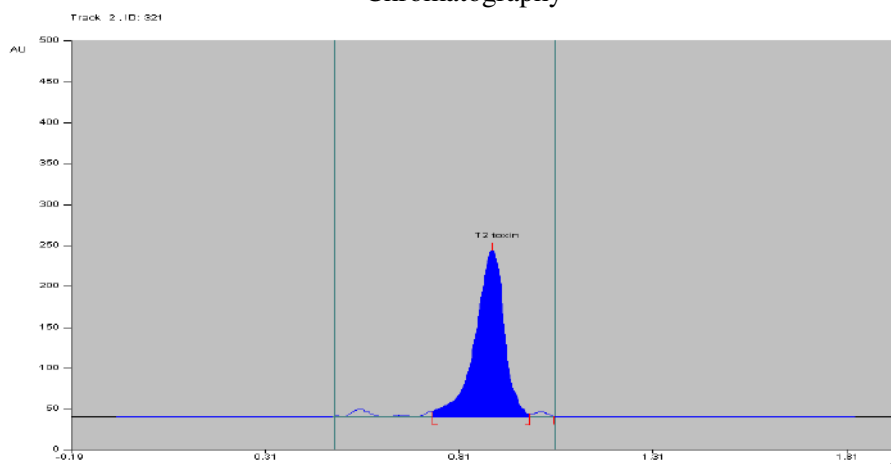


Area of Coloured region is calculated to determine the amount of citrinin present in Sample.

**Figure 6** T2 Toxin Standard Peak in High Performance Thin Layer Chromatography



**Figure 7** Positive sample peak indicating Presence of T2 Toxin in High Performance Thin Layer Chromatography



Area of Coloured region is calculated to determine the amount of T2 Toxin present in Sample.

### CONCLUSION

A commercially available lentil was taken for extending shelf life by using retort packaging. The test conducted for safety assessment. It was found that by retort packaging method can inhibit the microbial growth and extend the shelf life of the product. The water activity and Moisture was also checked due to do the addition of brine solution before entering into the retort processing. Hence it can be consumed even after a long duration of time without spoilage, the shelf life of the product is up to 8-12 months. This method will enhance the shelf life without causing any adverse effect. However further studies are required.

### REFERENCES

1. Alma Zhumabaevna Saikenova, Mukhtar Sarsenbekovich Kudaibergenov, Taken Nurgassenovich Nurgassenov (2021). Crop Yield and Quality of Lentil Varieties in the Conditions of the Southeast of Kazakhstan. *Journal of Biological Sciences*. (1): 33.40. pg: 34-38.
2. Mo'ez Al-Islam Ezzat Faris, Hamed Rabah Takturi and Ala Yousef Issa (2012). Role of lentils (*Lens culinaris* L.) in human health and nutrition. *Mediterranean Journal of Nutrition and Metabolism*. Pg: 3-16.
3. Vijay Sharma and Vandana Shukla (2014). Scenario of Lentil in India. *Journal of Advances in Life Sciences*. Vol: 3 (1): Pg:01-06.
4. U.S. Pal, M. Das, R.N. Nayak, N.R. Sahoo (2019). Development and evaluation of retort pouch processed chhenapoda (cheese based baked sweet) *Journal of Food Science Technology*. Vol: 56(1): Pg: 302–309.
5. K.M.Singh and A.K.Singh (2014). Lentils in India. Available at: [https://www.researchgate.net/publication/266968749\\_Lentil\\_in\\_India\\_An\\_Overview](https://www.researchgate.net/publication/266968749_Lentil_in_India_An_Overview).
6. D.M. Brichta-Harhay, T.M. Arthur and M. Koohmaraie (2007). Enumeration of Salmonella from poultry carcass rinses via direct plating methods. *Journal of Applied Microbiology*. Pg: 186-191.
7. Sanja Gunawardena and Marliya Ismail (2010). Investigation of Process Parameters in Retort Processed Food. Available at: <https://www.researchgate.net/publication/310772119>.
8. Kiev S. Gracias and John L. McKillip (2004). A Review of Conventional Detection and Enumeration methods for Pathogenic Bacteria in Food. *Canadian Journal of Microbiology*. Vol: 50: pg- 883–890.
9. Sushant Temgire, Anjan Borah, Sandip Kumthekar and Aniket Idate (2021). Recent trends in ready to eat/cook food products. *The Pharma Innovation Journal*. Vol: 10(5): 211-217.
10. Varalakshmi K, Prince Devadason, Babji Y and Rajkumar R S (2014). Retort Pouch Technology for Ready to Eat Products – An Economic Analysis of Retort Processing plant. *IOSR Journal of Agriculture and Veterinary Science*. Vol: 7.
11. Official Methods of Analysis of AOAC International. 2016. 19th Edition. Edited by Patricia Cuniff. Published by AOAC International. Virginia. USA. Test 17.2 .01.

12. Food Safety and Standards Authority of India., Manual of Methods of Analysis of Foods., Spices and condiments., Lab Manual 10.
13. P.A. Khatwani and Sourav Nag (2019). Review on the Study of structure of Polypropylene for development of different textile based products for packaging industries. *International Journal of Research and Analytical Reviews*. Vol: 06.pg:795- 797.
14. Sukrija Zvizdic, Sadeta Hamzic, Ines Rodins- Pejic and Fadila Avdic-Kamberovic (2019). Detection of Mycotoxins in Selected Food Samples. Available at: <https://www.bibliomed.org>.
15. Virat Abhishek, Kumar, R., Johnsy George, Nataraju, S., Lakshmana, J. H.,(2014). Development of retort process for ready-to-eat (RTE) soy-peas curry as a meat alternative in multilayer flexible retort pouches. *International Food Research Journal*. 21(4), pg:1553-1558.
16. Jayaramachandran Ramesh, Ghadevaru Sarathchandra and Veerapandian Sureshkumar, (2013). A validated HPTLC method for detection of Ochratoxin A and Citrinin contamination in feed, fodder and ingredient samples. *International Journal of Current Microbiology and Applied Sciences*. Pg: 352-356.

## **A Study on Effectiveness of Online Teaching Methods for Autonomus College Students**

**K. Chendur Priyadharshini<sup>1</sup>, C. Jestina Jeyakumari<sup>2</sup> and N. Muthuselvi<sup>3</sup>**

<sup>1</sup>Mangayarkarasi College of Arts and Science for Women, Madurai, India

<sup>2,3</sup>Department of Commerce, Mangayarkarasi College of Arts and Science for Women, Madurai, India

### **ABSTRACT**

COVID -19 containment taught several new things to everyone. This containment helped to spread our knowledge in the universal platform. Several scholars got opportunities to extend their hidden skills and expertise to reach many people. Most importantly, teaching through virtual mode has become the requisite part of academic establishments around the world because of the pandemic crisis of COVID-19. Online courses registration, webinar participations and of course the online regular classes helped many learners to continue their degree and to gain lots of knowledge virtually. This study aims to study the students' perspective towards e-learning through an online survey of 100 students. This is achieved by analysing the primary data obtained through structured questionnaire. Primary information was collected from II and III Years Students from various colleges around Madurai district. The study result shows that students accepted online mode of teaching during pandemic due to the fear of non-completion of their courses. Their satisfaction level would have improved if more interactive sessions were implemented with proper sharing of relevant study materials and videos of online classes through college website. This mode of teaching may not be accepted by the students after pandemic in the long run.

Keywords: e-Learning, Students attitude, Online classes, COVID-19, Satisfaction Level, interactive sessions.

### **INTRODUCTION**

Learning may be a continuous process; there's no regulation to find out one thing new in our life. During the olden days, students used to move to Gurukulam to transform them into smart personalities by obtaining the essence of knowledge from their Gurus. Later, large number of institutional establishments began to emerge in order to convert the scholars into Scientists, Doctors, and Entrepreneurs etc. The COVID -19 converted our routine life itself into a tragic one. Any trivial changes at the world level will definitely have its impact on the education sector hence COVID -19 conjointly has its path within the education sector too. To prevent the spreading of the virus worldwide, institutional establishments were forced to suspend physical classes. As a result of this, with the advancement of technology, it was possible to choose virtual platform and it proved to be a best alternative in the absence of physical classes.

Thus it paved the path towards e-learning. The government ordered to conduct the higher secondary examinations and college semester examinations for the year 2020 and 2021 through online mode. This was followed by issue of mark sheets to the passed out students and admission for the fresher who completed the higher secondary examinations also through online. As per the government order, all the institutions completed 2019-2020 year and began following year of 2020-21. It a sudden unplanned paradigm shifts, which carry some negatives. Students were badly affected during COVID-19 containment because their educational foundation became weak due to online teaching, learning and evaluation. The online instructors were given very less time to be mentally prepared for giving the entire classroom effect through online mode. In this article, a trial was created to analyze the Students' perspective towards online categories throughout pandemic in Madurai City. Learning through virtual mode has become a part of the education sector, during which the scholars and colleges are connected well. The employment of a desktop, laptop, or Smartphone's forms a serious element of this learning methodology. Thus e-learning gained greater importance during COVID-19 pandemic.

### **STATEMENT OF THE PROBLEM**

Teaching by the scholars on field which has been modified and shifted to a brand new setting through virtual mode is unaccustomed to the schools and also to the students during the pandemic period. Schools should be aware and equipped to handle the classes through Google meeting link, ZOOM, or MS-TEAM.

Apart from teaching, reviewing with essays, answering queries, conducting quiz, scrutinizing assignments are also additionally must have been completed online. Without the above mentioned criteria, online classes cannot be proved effective.



### SCOPE OF THE STUDY

Educational institutions were forced to adopt new teaching and learning methods along with other curriculum related activities which might be new challenges for them. Throughout this COVID-19, the education sector has been working on sophisticated methods for the betterment of students. Similarly, the students are also willing to continue their e-learning which might be a challenging journey for each student.

### OBJECTIVE OF THE STUDY

1. To analyse the students' attitude towards online classes
2. To analyse the satisfaction level of students during online classes.
3. To know about factors affecting online classes.

### REVIEW OF LITERATURE

Dr. N. Muthuselvi & Dr. C. Jestina Jeyakumar in their paper titled, "A Study on How Online Classes Affected the Students Mental Health in Pandemic Situation" concluded that though Internet has assumed an essential part during the pandemic, its results cannot be overlooked. The online classes cannot be brought to understudy because of the inaccessibility of cell phones and signal coverage to particularly helpless families and far off regions. This makes segregation among the understudies of poor and rich or metropolitan and rustic. The understudies under 14 years don't know about the screen impact and get dependent on versatile that causes mental and eye issues. Consequently, teaching through internet cannot take the situation of customary study hall instructing for quite a while and we should return to conventional educating after a pandemic closures.

### METHODOLOGY OF THE STUDY RESEARCH DESIGN

Descriptive and Analytical Research Design.

### DETERMINATION OF SAMPLE SIZE

**Sample Size:** 100 (Autonomous colleges - Madurai)

**Sampling Technique:** Convenient Sampling Technique

### SOURCES OF DATA

**Primary Source:** Structured Questionnaire was used to collect the data. Simple Percentage Method was adopted to measure the responses.

### LIMITATIONS OF THE STUDY

- The study is based on the attitudes of students alone and the factors given by them are subjective.
- The study covers only two educational institutions in Madurai city, hence it may vary with other colleges within or outside of Madurai city.
- Attitudes of students can be changed at any point of time, so the same respondents' responses may vary in the future.

### ANALYSIS AND INTERPRETATION

#### STUDENTS' ATTITUDE TOWARDS ONLINE CLASSES

**Table 1** Programme of the Respondents

S.NO	PROGRAMME	RESPONDENTS	PERCENTAGE
1	ARTS	58	58
2	SCIENCE	42	42
	TOTAL	100	100

**Source:** Primary Data

The above TABLE: 1 show that 58% of Arts students and 42% Science students participated in the survey. Maximum number of respondents was Arts students in this study.

**Table 2** Types of Teaching App Used For Students

S.NO	APP	RESPONDENTS	PERCENTAGE
1	GOOGLE MEET	34	34
2	ZOOM	38	38
3	GOOGLE CLASSROOM	28	28
	TOTAL	100	100

**Source:** Primary Data

In TABLE:2, although Google Meet, Zoom and Google Classroom have more or less similar preference, Zoom is preferred more than the other two apps.

**Table 3** Types of Devices Used For Online Classes

S.NO	TYPES OF DEVICE	RESPONDENTS	PERCENTAGE
1	MOBILE PHONE	65	65
2	LAPTOP	20	20
3	COMPUTER	15	15
	TOTAL	100	100

Source: Primary Data

The TABLE: 3 show the students' usage of device for online classes. It is obvious that with mobile phone being handy, 65% of the people prefer to use mobile phone from anywhere, but that would also be a hindrance for them in taking notes and being very much attentive. We do not know how many of them own laptop or computer and still uses mobile.

**Table 4** Attendance of Online Classes

S.NO	ATTENDANCE	RESPONDENTS	PERCENTAGE
1	YES	75	75
2	NO	25	25
	TOTAL	100	100

Source: Primary Data

The TABLE: 4 show the students' attendance rate. In a class room schedule, we wouldn't be asking this question, because all the students must attend. But, being the online class which makes the flexibility to attend, people are unable to stick to the schedule. 25% of the people finding hard to stick to schedule is a serious concern.

**Table 5** Online Classes Timing

S.NO	SPENDING TIME	RESPONDENTS	PERCENTAGE
1	3 HOURS	22	22
2	4 HOURS	30	30
3	MORE THAN 4 HOURS	48	48
	TOTAL	100	100

Source: Primary Data

Though the class timings are arranged by the teachers, TABLE: 5 shows almost 52% of the students attend less than 4 hours of classes. We need to study whether these class timings are scheduled continuously or after frequent intervals which will reduce their eye strain issues.

#### SATISFACTION LEVEL OF STUDENTS DURING ONLINE CLASSES

**Table 6** Satisfaction Level Of The Students

S.NO	SATISFACTION LEVEL	RESPONDENTS	PERCENTAGE
1	YES	49	49
2	NO	38	38
3	MAY BE	13	13
	TOTAL	100	100

Source: Primary Data

In TABLE: 6, even though students satisfaction with the teaching apps are 49% , the opposite which is "NO" and "MAY BE" together is 51%. We can interpret that as 50-50 on both sides.

**Table 7** Interest on Online Classes

S.NO	INTEREST	RESPONDENTS	PERCENTAGE
1	YES	26	26
2	NO	30	30
3	MAYBE	44	44
	TOTAL	100	100

Source: Primary Data

It is clear from the TABLE: 7 that only 26% are confident enough to tell that the online classes are interesting. Balance 74% indirectly says the classes are either boring or not effective to inculcate knowledge. This study will be a valid point in deciding about the effectiveness of online classes.

**Table 8** Taking Notes during the Class

S.NO	TAKING NOTES	RESPONDENTS	PERCENTAGE
1	YES	15	15
2	NO	40	40
3	MAYBE	45	45
	TOTAL	100	100

Source: Primary Data

In TABLE: 8 it is interesting to note that only 15% of the students take notes. Some of the 45% of the “MAY BE” students might take notes occasionally. But overall it is not appreciated to see that they don’t take notes and they attend the online class for the sake of attending the class.

**Table 9** Faculty Providing Resources to Learn From Home

S.NO	PROVIDE A RESOURCES	RESPONDENTS	PERCENTAGE
1	YES	65	65
2	NO	23	23
3	MAYBE	12	12
	TOTAL	100	100

Source: Primary Data

In TABLE: 9, predominantly about 65% says the faculties provide resources and we can count on the “MAY BE” students also. Perhaps the 23% of students may have meant enough resources were not provided rather than any resources.

#### FACTORS AFFECTING ONLINE CLASSES

**Table 10** Factors Affecting Online Classe Teaching:

S. No	Factors	Strongly Agree	Agree	Neutral	Disagree	Total	Rank
1	Students do not take online classes seriously	65	25	4	6	100	I
2	Students make lot more excuse not attending online classes and the reliability of it cannot be assessed	45	15	8	32	100	IV
3	Students show lack of interest and involvement during online classes	32	18	13	37	100	IX
4	Students feel motivated to participate in online class discussions	48	29	8	15	100	III
5	Lack of computer skills makes the students uncomfortable during online classes	39	47	7	7	100	VII
6	Students get easily distracted and difficult to concentrate the online classes	42	47	5	6	100	V
7	Students get technical issues during online classes	51	42	3	4	100	II
8	Students doubts not to be cleared during online classes because of timing	36	47	7	10	100	VIII
9	Students get more disturbance from house during online classes	40	50	1	9	100	VI

Source: Primary Data

Most of the answers in TABLE:10 make it louder and clear that the online classes are not effective. 90% of the students agree that they don’t take online classes seriously. It is very interesting to note that the focus on learning is affected in online classes as confirmed by the table that 89% of the students agree that they get

distracted and 90% of the students agree that being at home disturbs them. Unless students have a dedicated room exclusively for online classes at every home the online classes will be ineffective as focus in studies is very important for learning. The agreement of 93% of the students that they face technical issues which can be due to app malfunctioning or internet connectivity issues, which is very common everywhere, is a valid frustrating point. The feeling of 86% of students that their computer skills make them uncomfortable can be resolved through proper training. However, considering the other ineffectiveness providing training alone will not make the online classes more effective. When 77% of the students feel they are motivated to participate, it is obvious that the time will run out that is why 83% feel that they themselves give excuses for either not attending or discontinuing a class. Such excuses cannot be verified like telling "I have technical issues to connect."

### SUGGESTIONS

- Students study 5 to 6 subjects in a semester through e-learning. Time management is a serious constraint for them to complete the educational work.
- Although virtual learning helps them to boost their data, they face some health issues due to prolonged screen timings and lack of physical movements. Hence the learners and college should take responsibility to find some effective alternatives.
- The major disadvantage in e-learning is that it doesn't establish the reaction of the scholars, therefore with different mode of teaching the colleges can prepare for sharing the views of scholars in e-learning.

### CONCLUSION

Though online classes prevented the disruption of knowledge flow in the education field, it had negative influence on the learners' performance and outcome. Students have the tendency to lose interest and involvement in the subject matter due to the stress they encounter in virtual learning. Above all, online examinations and evaluations don't give special recognition to real hardworking and talented students. Their active interactions on subject matters in the real time classroom are also hindered in virtual mode. In spite of all these disadvantages, the findings of our study say that the students were benefitted to certain extent in the pandemic through online class without facing total discontinuity in their studies. They showed acceptable participation in online classes by managing all the hurdles they encountered in their home atmosphere. Their interest can be provoked through interactive sessions with subject related quizzes and games. Further, due to lack of time during online sessions students are not able to take notes. This can also be overcome by posting the relevant subjects materials in college websites with password access.

### REFERENCES

1. Dhamija, Neelam. "Attitude of Undergraduate Students Towards the use of e-Learning." *MIER Journal of Educational Studies, Trends and Practices*, vol. 4, 2016, pp. 123-135.
2. Kisanga, Dalton H. "Determinants of Teachers' Attitudes towards E-Learning in Tanzanian Higher Learning Institutions." *International Review of Research in Open and Distributed Learning*, vol. 17, no. 5, 2016, pp. 109-125.
3. Dr. N. Muthuselvi & Dr. C. Jestina Jeyakumar(2021) in their paper title, "A Study on online classes affected the students mental health in this pandemic situation" *VB Publication*, issn no: 2319-4979,pg.no:254-258.
4. Margaret Divya, A., and Suganthi Priya. "A Study on the Impact of Covid-19 on Students Learning Experiences with Special Referenceto Madurai City." *ComFin Research*, vol. 9, no. 1, 2021, pp. 11-16.
5. Peytcheva-Forsyth, Roumiana. "Factors AffectingStudents' Attitudes Towards Online Learning- The Case of Sofia University." *AIP Conference Proceedings*, 2018.
6. Saravanakumar, AR., et al. "Educational Technological Vision on Distance Mode (DM) in Teacher Education Programme (TEP)." *Global Web Conference on Multidisciplinary Research and Development*, 2020.
7. Abbasi, Sahar, et al. "Perceptions of Students regarding E-learning during Covid-19 at aPrivate Medical College." *Pakistan Journalof Medical Sciences*, vol. 36, 2020.
8. Adewole-Odeshi, Egbe. "Attitude of Students Towards E-learning in South-West Nigerian Universities: An Application of Technology Acceptance Model." *Library Philosophy and Practice*, 2014.

## Evaluation of Quality Criteria on Mango Pickles

C. Thabithal Helina<sup>1</sup> and Ghadevaru Sarathchandra<sup>2</sup>

<sup>1</sup>Department of Food Process Engineering, SRM Institute of Science and Technology, Kattankulathur, Chengalpattu District, Tamil Nadu, India

<sup>2</sup>Pharmacovigilance Laboratory for Animal Feed and Food Safety, TANUVAS, Chennai, Tamil Nadu, India

### ABSTRACT

**Background:** Mango pickles are immensely common across Asia. In every Indian household, they are the most frequently consumed condiment. It is abundant in antioxidants and has nutritional values, including vitamin K and fibre. The goal of this study was to assess the quality of several market pickle samples. They were evaluated by completing a survey that included checking for adulterants, calculating sensory evaluations, and checking for microbial contamination.

**Methods:** The total plate count (TPC) method was used to determine microbiological contamination for each pickle sample. To measure the levels of rancidity, the peroxide value was calculated for all pickle samples. Physicochemical characteristics such as water activity, moisture, pH, and colour were examined. High-performance thin-layer chromatography (HPTLC) was used to determine the amounts of aflatoxin and other mycotoxins in the samples.

**Results:** The aerobic plate count of mango pickles ranged from  $1.5 \times 10^3$  to  $3.6 \times 10^2$  cfu/g. Concerning physicochemical parameters, 50% of the pickle samples were found to be within the acceptable range. The rancidity test showed that 2 out of 4 samples were rancid.

**Conclusion:** This study shows that 2 out of 4 samples have the quality and sensory characteristics that meet the guidelines, showing that the pickles are available in both good and bad quality in the market.

Keywords: microbial load, physicochemical parameters, pickle, rancidity, sensory analysis.

### INTRODUCTION

Mango (*Mangifera indica* L.) is a well-known tropical fruit in the Anacardiaceae family. India is the leading producer, accounting for 57.18 percent of total global output with an annual production of around 10.99 million tonnes. Mangoes, which are classed as climacteric fruits, ripen quickly after being picked. The perishable nature of the fruit makes it difficult to transport harvest to distant locations. Such fruits can be used to make pickles to reduce losses. Pickles can be made with meat, vegetables, or fruits. Mango pickle is the most popular and widely used. Mango pickles are a popular Indian export (Katike Umamahesh et al., 2020). Pickles are a type of food product that is preserved with salt, vinegar, and spices. They're a lactic acid-ripened vegetable that's minimally salted. Pickles contain acetic acid, which acts as a preservative to extend the shelf life of the product (Shannon Rezac et al., 2018).

Adulteration has found a unique way into the pickle industry. Any type of aluminium sulphate, including those that are toxic, is referred to as "alum". The type of alum used for pickling is commonly known as potassium alum. Aluminium makes pickles crisper and firmer by strengthening the cell walls of fruits and vegetables. It is dangerous in large amounts. The current trend is to use fewer chemicals to enhance food texture. Adulterants such as chalk powder, white sand, washing soda, plastic crystals, and urea are commonly used. The most serious side effect of alum consumption is lung damage. Diarrhea, nausea, and vomiting are all side effects of washing soda (A Rahman et al., 2014).

In light of the above discussion, the current study focuses on a complete examination of mango pickles on the market, which is fulfilled by comparing four different samples and evaluating their quality factors as well as the occurrence of adulterants using the methodologies outlined below.

### MATERIALS AND METHODS

#### SAMPLING

Four mango pickle samples procured from the market were named A, B, C, and D. The samples were retrieved and maintained in sealed containers for analysis. All the tests listed below were performed in duplicates or triplicates.

---

---

## PHYSICOCHEMICAL PARAMETER TESTING

### MOISTURE

The moisture content of all pickle samples was determined by placing 3g of sample in a hot air oven for 3 hours at 105°C and calculating the weight difference. The experiment was carried out in triplicates (AOAC., 2016).

### WATER ACTIVITY

The water activity (aw) in pickle samples was determined by placing 1g of the sample in the water activity meter (nova sina). The readings were noted. The experiment was performed in duplicates (AOAC., 2016).

### PH

The pH of the pickle samples was tested using a pH meter. 10g of samples were taken in a beaker with 10 ml of distilled water. The pH meter is inserted into the beaker. The readings were noted (AOAC., 2016).

### COLOUR MEASUREMENT

A hunter colorimeter (HunterLAB-ColorQuest XE) was used to determine the colour of all four samples at a wavelength of 650 nm. Each sample's graph was plotted (NiCheng et al.,2018).

### Microbial Contamination

Pickle samples were analysed for aerobic plate count (APC) and yeast and mould count (YM). Briefly, 1ml of food homogenate is poured into each petri dish with the total plate count (TPC) agar. The mixture was incubated at 35°C for 24/48hours. The number of colonies was recorded (AOAC., 2016).

### RANCIDITY ESTIMATION

The level of rancidity in pickle samples was determined by calculating the peroxide value. The peroxide concentration was measured according to the FSSAI, (2011) protocol. The appearance of violet colour indicates positive rancidity.

### Estimation of Mycotoxin Using High-Performance Thin-Layer Chromatography (HPTLC) Estimation of Multi-Toxin

Place a 25g sample, 88ml of acetonitrile, 2ml of 20% sulfuric acid (H<sub>2</sub>SO<sub>4</sub>), 4% potassium chloride (KCL), and 1 scoop of sodium chloride (NaCl) in a shaker for 30 minutes. Filter the liquid with filter paper. Add 50ml of the filtered sample, 50ml of distilled water, and 50ml of hexane to a 250ml separating funnel (shake). Collect the lower layer in a measuring cylinder and toss out the top layer. In a 250ml separating funnel (Shake), 50ml of the lower sample and 50ml of hexane were combined. Wash the separating funnel and collect the lower part in a measuring cylinder. 50ml collected lower sample and 20ml of chloroform were taken in a 250ml separating funnel (shake and allow to separate). By gently tilting the separating funnel, the bottom layer will be collected over anhydrous sodium sulphate (Na<sub>2</sub>SO<sub>4</sub>) bed. Vaporize till almost dry (Ramesh et al., 2010).

## RESULTS

### Physicochemical Parameters

#### Moisture and Water Activity Of The Mango Pickle

The moisture level of the four samples varied between 40% and 67%. At temperatures ranging from 28.3 to 28.5 degrees, the water activity was in the range of 0.755 to 0.795.

### PH

A food's pH is a direct function of the amount of free hydrogen ions it contains. These hydrogen ions are released by acids in foods, giving them their unique sour flavour. Therefore, pH can be thought of as a measure of free acidity. pH is estimated by taking the negative log of hydrogen ion concentration. The pH ranged from 2.78 to 3.20 in the four samples.

### COLOUR DETECTION

A graphical representation of the peaks of four samples is shown in figure1. Visible Spectrum Details:

Colour - Red

Wavelength - 650nm

Frequency - 1.91Hz

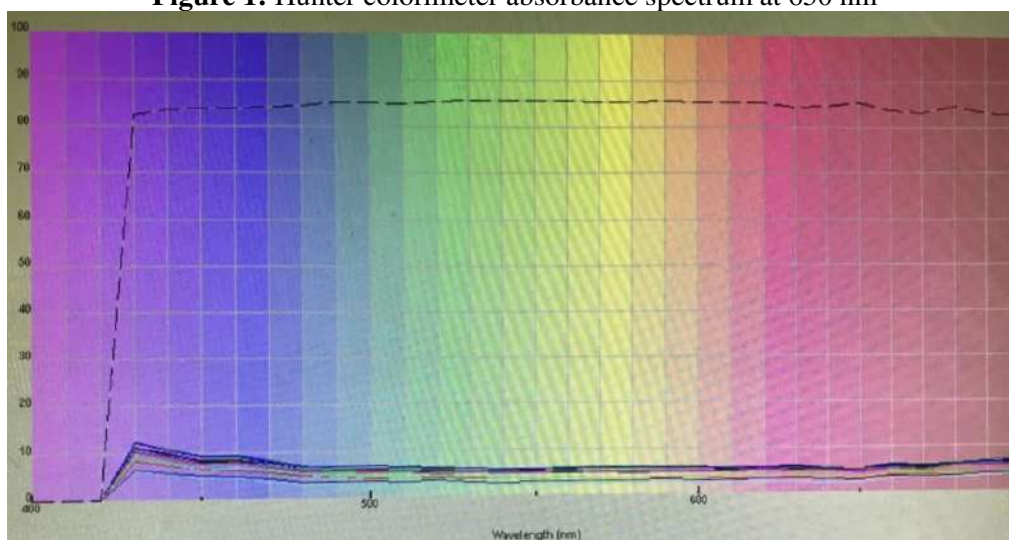
Energy - 1.77 eV

L is the product's lightness, +a\* is its redness, -a\* is its greenness, +b\* is its yellowness, -b\* is its blueness, and dE is its total colour difference. Mean values of 3 readings of each colour were noted at wavelengths of 650 nm.

**Table1:** Colour analysis using the Hunter Colorimeter at wavelengths of 650 nm.

Samples	L	a*	b*	dE*
A1	27.50	1,47	-7.26	68.36
A2	20.72	2.27	-7.72	75.12
A3	18.51	2.86	-9.06	77.61
B1	29.44	1.83	-9.11	66.95
B2	23.60	2.03	-9.64	72.73
B3	23.11	1.40	-9.10	73.03
C1	26.98	2.27	-8.41	69.20
C2	28.02	1.44	-8.56	68.15
C3	27.89	2.28	-9.25	68.52
D1	29.38	2.65	-9.02	67.07
D2	28.00	2.43	-8.69	68.29
D3	27.50	2.62	-9.02	68.88

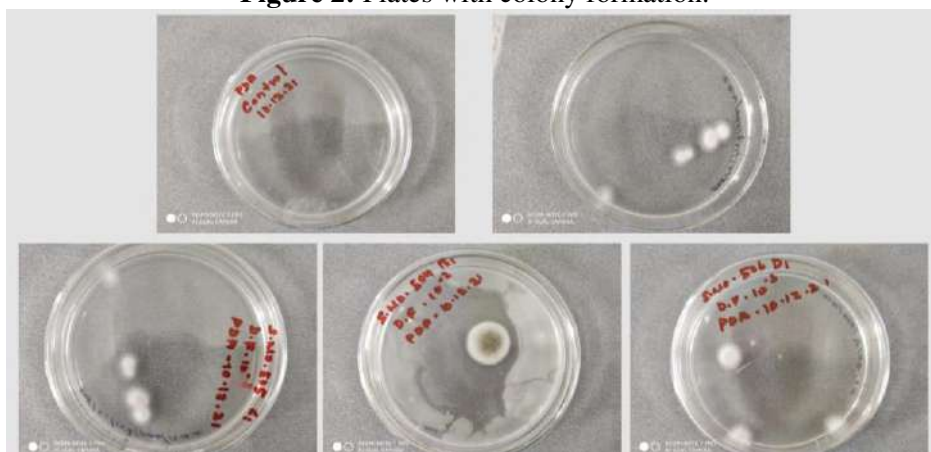
**Figure 1:** Hunter colorimeter absorbance spectrum at 650 nm



**Microbial contamination**

According to the microbiological investigation, the aerobic plate count (APC) of mango pickle samples ranged from  $1.5 \times 10^3$  to  $3.6 \times 10^2$  cfu/g. In this case, 25% of the samples were below the detection limit (BDL). The pickles' yeast and mould (YM) counts varied from  $1 \times 10^3$  to  $4 \times 10^3$ , with 25% of the samples being too numerous to count (TNTC).

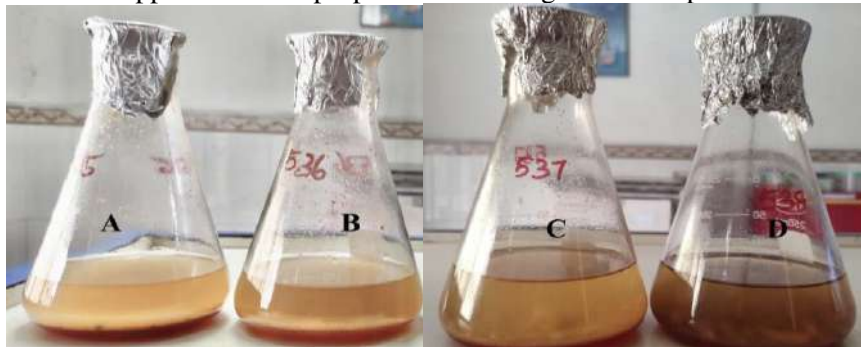
**Figure 2:** Plates with colony formation.



**RANCIDITY ESTIMATION**

The presence of oil in the pickles mandates the need for a peroxidation test. The calculated peroxide values and the positive results are shown in table 2 and figure 3. The peroxide levels in the four analysed samples ranged from 3.5 to 13.5.

**Figure 3:** The appearance of a purple-coloured ring shows the presence of rancidity



### Estimation of Mycotoxin

All four pickle samples were subjected to aflatoxin estimation, including aflatoxin B1, B2, G1, and G3, as well as a multi-toxin test to identify Citrinin, Ochratoxin A, and T2 toxin. All of the estimates were below the detectable limit, indicating that aflatoxin and multi-toxin were not present in any of the samples.

## DISCUSSION

### Physicochemical parameters

#### Moisture and water activity of the mango pickle

The reaction of water in the food with bacteria is referred to as water activity. Moisture content shows how much water is present in the food and ingredients, whereas water activity refers to how that water interacts with bacteria. The more the water activity, the quicker bacteria, yeast, and mould can develop, leading to improved food storage standards. In this study, 75% of the samples were within the acceptable range. The acceptable limit of moisture in pickles, according to FSSAI standards, is roughly 63 percent. The permissible range of water activity in pickles is 0.85 to 0.89 aw. 75% of the samples fell below the systemic level.

### PH

The capacity of microorganisms to grow on a fermented pickled item is influenced by acidity. The acidity of a particular food item should be enhanced to prevent the growth of germs. Acidity should be kept at a level that inhibits the growth of germs while remaining safe for human consumption (Misha Anishkumar Patel., 2019). According to FDA regulations, the standard pH range for pickles is 4.6 or below. All of the mango pickles that were evaluated had pH levels that were within the standard range.

### COLOUR DETECTION

The rationale for examining the pickle samples' colours is that many firms use food colorings to improve the appearance of their products. Color detection using a hunter calorimeter has been used to analyse the additional food colorings.

### Microbial contamination

The main reasons for microbial contamination are improper processing, insufficient amounts of oil and salt, improper packaging, and the use of mouldy vegetables (Amani H. Aljahani., 2020). The acceptable limits for aerobic plate count (APC) and yeast and mould count, according to FSSAI regulations, are  $10^8$  cfu/g and  $1 \times 10^3$  cfu/g, respectively. In this study, 100% of the samples were within the allowed limit for APC, whereas 75% of the samples for YM were within the permissible range and 25% were not.

### RANCIDITY ESTIMATION

Rancidity is a condition caused by the oxidation of unsaturated fat in foods at high altitudes. The reason for evaluating the rancidity level in pickles is that oil is not soluble in water, thus water does not dissolve in the oil, destroying the pickle's surface (Chiew LetChong., 2012). According to the FSSAI, a peroxide value of 10 mEq/kg (milliequivalent) or less is not considered rancid. In this study, 50 percent of the samples were rancid, and 50 percent were free from rancidity.

### ESTIMATION OF MYCOTOXIN

Mycotoxigenic fungi can be found in a variety of crops. The primary determinants of fungal contamination and mycotoxin production include environmental factors such as water activity (aw), temperature, acidity, and nutritional source. According to Jessica Costa, (2020), chillies and their derivative products are very vulnerable to infection by mycotoxins. Aflatoxin, Zearalenone, Ochratoxin A, and Patulin have been found in paprika, chilli sauce, and capsicum seasonings. The current investigation, on the other hand, found no mycotoxin in the pickled fruit with spices.



## CONCLUSION

A statistical analysis was performed to analyse the safety criteria of commercial pickles. It revealed that 2 out of 4 samples were up to the standards. The samples were examined for microbial contamination, and it was observed that due to the minor increase in moisture content, half of the samples had a high microbial count. There was also evidence of rancidity. Furthermore, this study demonstrates that there are both high-quality and low-quality pickles available on the market. It is imperative to conduct periodic monitoring of the quality of pickles to assure consumer safety.

## REFERENCE

1. Amani H.Aljahani. (2020). Microbiological and physicochemical quality of vegetable pickles. Journal of the Saudi Society of Agricultural Sciences. Volume 19, Issue 6. pp: 415-421
2. Anthony D. Hitchins., Karen Jinneman and Yi Chen. (2017). Detection of *Listeria monocytogenes* in Foods and Environmental Samples, and Enumeration of *Listeria monocytogenes* in Foods. Bacteriological Analytical Manual. Chapter 10.
- A. Rahman., M. S. Kayshar., M. Saifullah and M. B. Uddin. (2014). Evaluation of quality status and detection of adulterants in selected commercial pickles and chutneys based on consumer attitude and laboratory analysis. J.Bangladesh Agril. Univ. 12(1): 203–209.
3. Chiew Let Chong. (2012). Measurement and Maintenance of Palm Oil Quality. Palm Oil Production, Processing, Characterization, and Uses. pp: 431-470.
4. C. Mondal., S. Sultana., M. A. Mannan and S. A. K. U. Khan. (2016). Preparation and Sensorial Evaluation of Pickles, Jam, Jelly and Squash Developed from Jackfruit (*Artocarpus heterophyllus*). J. Environ. Sci. & Natural Resources, 9(2) 35-41.
5. Filiz Yangilar., Pınar Oğuzhan Yıldız and Pınar Çelik Kizilkaya. (2017). Determination of Microbiological, Chemical, Physical and Sensory Properties of Pickles Produced from Organic Kımı Plant Using Whey at Different Concentrations During Storage. Journal of Science and Technology. (11), 1.
6. Food safety and standard (contaminants, toxins and residues) regulation. (2011).
7. Gahane KD., Choudhari RJ., Tayade SA and Patil SR. (2019). Study of biochemical variability in local mango genotypes for pickle purpose. International Journal of Chemical Studies. 7 (4). 2795 - 2799.
8. Jéssica Costa., Rodrigo Rodríguez., Esther Garcia-Cela., Angel Medina., Naresh Magan., Nelson Lima., Paola Battilani and Cledir Santos. (2020). Overview of Fungi and Mycotoxin Contamination in Capsicum Pepper and Its Derivatives. Toxins. 11, 27.
9. NiCheng., David M.Barbano., Mary Anne Drake. (2018). Hunter versus CIE color measurement systems for analysis of milk-based beverages. Journal of dairy science. Volume 101. Issue 6. pp- 4891 - 4905 [DOI: <https://doi.org/10.3168/jds.2017-14197>]
10. Katike Umamahesh., Arumugam D Gandhi., Obulam V S Reddy. (2020). Ethnopharmacological Applications of Mango ( *Mangifera indica* L.) Peel. Current Pharmaceutical Biotechnology. 21(13):1298-1303.
11. Misha Anishkumar Pate. (2019). Effect of Physical and Microbiological Parameters on Ready Made Pickles: A Review. International Journal of Food Science and Nutrition Engineering. 9(2): 31-36. [DOI:10.5923/j.food.20190902.01]
12. M.Z. Hassan., M.M. Rahman., M.Z. Ali., M.A. Yousuf., S. Akther., M.H. Rahman., M.A. Islam and A. Hossen. (2020). An overview of Mycotoxin contamination of animal feeds. Bangladesh Journal of Livestock Research. 21-25:1-9
13. Official Methods of Analysis of AOAC International. (2016). 16th Edition. Virginia. USA. Shannon Rezac., Car Reen Kok., Melanie Heermann., and Robert Hutkins. (2018).
14. Fermented Foods as a Dietary Source of Live Organisms. Pub med central. 9: 1785.
15. SL Pal., Devi Singh and PK Attri. (2018). Evaluation of physico-chemical properties of different types of pickles of wood apple (*Limonia acidissima*). Journal of Pharmacognosy and Phytochemistry. 1184-1187.

## **The Status of the Government Health Programmes in the Government Schools in Imphal East District of Manipur: A Case from Health Education Teachers**

**Bob Dev Waikhom and Yengkhom Santikumar Singh**

Department of Physical Education & Sports Science, Manipur University, Canchipur, Imphal, India

### **ABSTRACT**

This paper is an attempt by the researchers to investigate how the health education teachers in the government school reacted to the status of the government health education programme. In order to realise the objective, a survey was conducted in 2021–22 to ascertain the status of health education programmes in government schools. The survey was filled out by 100 health education teachers from government schools throughout Imphal East District of Manipur. The participants were selected through the snowball sampling technique. The survey instrument was a 9-item questionnaire (closed-ended) constructed specifically for the purpose of the current study based on the objectives of the Operational Guidelines for School Health Programme under Ayushman Bharat. The results indicated that the schools 1) send their teachers to train as Health & Wellness Ambassadors; 2) provide age-appropriate information about health and nutrition to the children; 3) promote healthy behaviours among the children that they will inculcate for life; 4) detect and treat diseases early in children and adolescents; 5) the schools promote the use of safe drinking water in schools; 6) promote safe menstrual hygiene practices by girls; 7) promote yoga and meditation through Health & Wellness Ambassadors. However, the result also indicated that the schools do not 8) encourage research on health, wellness, and nutrition for children and 9) keep an electronic health record for each student.

Key words: government schools, health education teachers, health and wellness ambassadors, Imphal East District, status of the government health programmes

### **INTRODUCTION**

Interventions early in life are the need of the hour when it comes to controlling the rising incidence of communicable and non-communicable diseases. The Government of India has directed many policies and programmes as part of the Global School Health Initiative to integrate health deeply into school activities. School Health Promotion is an international need with programmes implemented across continents due to numerous documented benefits, to not just the individuals but to the community and country as a whole. Simple teachings such as hand hygiene have been shown to reduce the incidence of diarrhoea in children, highlighting the urgent need to develop a model for health promotion at schools that is replicable, sustainable, and adaptable to local needs. Though existing programmes have a few documented challenges, a multi-sectorial involvement of government agencies, educational boards, and the health sector, in addition to the school, is the way forward to address those challenges and turn the theory of health promoting schools (HPS) into a well-established fact. It presents an opportunity for the various established and newly emerging schools of public health in the country to come forward and collaborate with these multiple sectors. This type of collaboration can be the only way to ensure sustainability and the incorporation of health promotion into the core academic structure of schools.

Children attend primary school from the age of six until they reach the mixed dentition period of roughly nine years, and they spend the most of their time there with the teachers. Teachers are likely to be among the first to visit a child following an injury, and their understanding of emergency protocols is crucial to ensuring a positive clinical outcome.

### **REVIEW OF LITERATURE**

Little research has been done in this direction. In this context, we have presented some of the literature that deals with school health programmes in Indian schools.

Kaushal et al. (2015) conducted a study to examine the impact of health education on the knowledge, attitudes, and practises of teachers regarding the reproductive health of adolescents. Taranath, Senaikarasi, & Manchanda (2017) conducted a study to evaluate, by means of a questionnaire, the primary school teacher's knowledge and attitude with regard to emergency management of traumatised avulsed teeth and to test the effectiveness of a health education tool. Naidu & Nandlal (2017) conducted a study to appraise the efficiency of a primary preventive dental health education programme conducted for 6-to 12-year-old primary school children in Mysore City. Shankar, Sievers, & Sharma (2020) conducted a programme evaluation of Girls Health Champions, a school-based peer education intervention in Mumbai, India that educates girls about leading

causes of adolescent morbidity and mortality, including nutrition, mental health, and sexual and reproductive health.

From this backdrop, we conducted a study to ascertain the status of the government health programmes in the government schools in Imphal East District of Manipur from the perspective of school health education teachers.

### OBJECTIVE

To study the reactions of school health education teachers on the status of Health Education Programmes in government schools.

### HYPOTHESES

- **H<sub>0</sub>**: An equal number of health education teachers support each statement.
- **H<sub>1</sub>**: An equal number of health education teachers do not support each statement.

### MATERIAL AND METHODS

A survey was conducted in 2021–22 to ascertain the status of health education programmes in government schools. The survey was filled out by 100 health education teachers from government schools throughout the Indian state of Manipur. The participants were selected through the snowball sampling technique. The survey instrument was a 9-item questionnaire (closed-ended) constructed specifically for the purpose of the current study based on the objectives of the Operational Guidelines for School Health Programme under Ayushman Bharat.

### DATA ANALYSIS

The data collected through the 9 closed-ended items were analysed with the help of descriptive statistics like percentages and inferential statistics like the Chi-Square Test by using Microsoft Excel and SPSS Statistics Version 22. The results of the data analysis are shown in table no. 1.

### THE RESULTS

**Table 1:** Chi Square Test results of the responses of the health education teachers on the status of Health Education Programmes in the government schools

Item No.	Statement	Yes (%)	No (%)	$\chi^2$	Sig. 2-tailed
1	Do you train as 'Health & Wellness Ambassadors' to transact health promotion and disease prevention information in the form of interesting activities for one hour every week?	61	39	4.84*	.028
2	Do you provide age appropriate information about health and nutrition to the children in schools?	71	29	17.64**	<.0001
3	Do you promote healthy behaviours among the children that they will inculcate for life?	71	29	17.64**	<.0001
4	Do you detect and treat diseases early in children and adolescents including identification of malnourished and anaemic children?	76	24	27.04**	<.00001
5	Do you promote use of safe drinking water in schools?	100	0	100**	<.00001
6	Do you promote safe menstrual hygiene practices by girls?	61	39	4.84*	.028
7	Do you promote yoga and meditation through Health & Wellness Ambassadors?	71	29	17.64**	<.0001
8	Do you encourage research on health, wellness and nutrition for children?	48	52	0.16	.689
9	Do you keep an electronic health record for each student?	49	51	0.04	.841

**Source:** Calculated from Field Survey data.

\*Significant at 0.05 level

\*\*Significant at 0.01 level

Statement 1: The result indicates that the schools send their teachers to train as 'Health & Wellness Ambassadors' to transact health promotion and disease prevention information,  $\chi^2(1, N = 100) = 4.84, p = .028$ .

Statement 2: The result indicates that the teachers provide age-appropriate information about health and nutrition to the children in schools,  $\chi^2(1, N = 100) = 17.64, p <.0001$ .

Statement 3: The result indicates that the teachers promote healthy behaviours among the children that they will inculcate for life,  $\chi^2(1, N = 100) = 17.64, p < .0001$ .

Statement 4: The result indicates that the teachers detect and treat diseases early in children and adolescents including identification of malnourished and anaemic children,  $\chi^2(1, N = 100) = 27.04, p < .00001$ .

Statement 5: The result indicates that the teachers promote use of safe drinking water in schools,  $\chi^2(1, N = 100) = 100, p < .00001$ . The result indicates that the schools promote safe menstrual hygiene practices by girls,  $\chi^2(1, N = 100) = 100, p < .00001$ .

Statement 6: The result indicate that the teachers promote safe menstrual hygiene practices by girls,  $\chi^2(1, N = 100) = 4.84, p = .028$ .

Statement 7: The result indicates that the teachers promote yoga and meditation through Health & Wellness Ambassadors,  $\chi^2(1, N = 100) = 17.64, p < .0001$ .

Statement 8: The result indicates that the teachers do not encourage research on health, wellness and nutrition for children,  $\chi^2(1, N = 100) = 0.16, p = .689$ .

Statement 9: The result indicates that the teachers do not keep an electronic health record for each student,  $\chi^2(1, N = 100) = 0.04, p = .841$ .

## CONCLUSIONS

The main purpose of the study was to ascertain the status of the government health programmes in the government schools in Imphal East District of Manipur from the perspective of school health education teachers. The survey was conducted in 2021–22. The survey was filled out by 100 health education teachers from government schools throughout the Indian state of Manipur. The participants were selected through the snowball sampling technique. The survey instrument was a 9-item questionnaire (closed-ended) constructed specifically for the purpose of the current study based on the objectives of the Operational Guidelines for School Health Programme under Ayushman Bharat. On the basis of the results, it is concluded that: 1) the schools send their teachers to train as ‘Health & Wellness Ambassadors’ to transact health promotion and disease prevention information in the form of interesting activities for one hour every week; 2) teachers Provide age-appropriate information about health and nutrition to the children in schools; 3) teachers Promote healthy behaviours among the children that they will inculcate for life; 4) teachers Detect and treat diseases early in children and adolescents including identification of malnourished, and anaemic children; 5) teachers Promote the use of safe drinking water in schools; 6) teachers Promote safe menstrual hygiene practices by girls; 7) teachers Promote yoga and meditation through Health & Wellness Ambassadors. Whereas, it is also concluded that the teachers 8) do not encourage research on health, wellness, and nutrition for children; 9) do not keep an electronic health record for each student. Therefore, it is suggested that the schools need to encourage research on health, wellness and nutrition for children and keep an electronic health record for each student.

## REFERENCES

1. Kaushal, P., Singh, T., Padma, A. S., Deepthi, S. S., Bansal, P., Satija, M., Sharma, S., & Ankita (2015). Impact of Health Education on the Knowledge, Attitude and Practices of Teachers Regarding Reproductive Health of Adolescents of Amritsar, Punjab. *Journal of clinical and diagnostic research: JCDR*, 9(5), LC18–LC21.
2. MHRD & MHFW, Government of India. (2018). *Operational Guidelines on School Health Programme under Ayushman Bharat*. New Delhi: Government of India.
3. Naidu, J., & Nandlal, B. (2017). Evaluation of the Effectiveness of a Primary Preventive Dental Health Education Programme Implemented Through School Teachers for Primary School Children in Mysore City. *Journal of International Society of Preventive & Community Dentistry*, 7(2), 82–89.
4. Shankar, P., Sievers, D., & Sharma, R. (2020). Evaluating the Impact of a School-Based Youth-Led Health Education Program for Adolescent Females in Mumbai, India. *Annals of global health*, 86(1), 57.
5. Taranath, M., Senaikarasi, R. M., & Manchanda, K. (2017). Assessment of knowledge and attitude before and after a health education program in East Madurai primary school teachers with regard to emergency management of avulsed teeth. *Journal of the Indian Society of Pedodontics and Preventive Dentistry*, 35(1), 63–67.

## Aflatoxins in Milk and Milk Products: Detection, Control and Decontamination - A Review

Shantanu M<sup>1\*</sup> and Sarathchandra Ghadevaru<sup>2</sup>

<sup>1</sup>Department of Food Process Engineering, School of Bioengineering, College of Engineering & Technology, SRM Institute of Science and Technology, Kattankulathur, Chennai, Tamilnadu, India

<sup>2</sup>Pharmacovigilance Laboratory for Animal Feed and Food Safety, Tamilnadu Veterinary and Animal Sciences University, Madhavaram, Chennai, Tamilnadu, India

### ABSTRACT

Milk is often contaminated with many toxins, with aflatoxins being the most prominent of them. Aflatoxin M<sub>1</sub> (AFM<sub>1</sub>) is a toxin of high risk in milk, due to its carcinogenicity, mutagenicity, teratogenicity and immunosuppressive effects on humans. The worldwide occurrence and prevalence of aflatoxins in milk products has raised the need for strict legislation to regulate these toxins at safe levels for human consumption. The carryover of aflatoxin B<sub>1</sub> from feed to aflatoxin M<sub>1</sub> in milk is a great concern for vulnerable age groups such as infants and the elderly. Currently, the European Union and the US Food and Drug Administration have set legal limits for the presence of aflatoxins in dairy products. Nevertheless, the incidence of aflatoxins in milk and milk products is reported in levels higher than the regulatory limits. This paper reviews some of the analytical methods used to detect aflatoxins and various strategies for the control and decontamination of aflatoxins in milk products.

Keywords: Milk, aflatoxins, control, detection methods, decontamination

### 1. INTRODUCTION

Milk is a nutrient-rich liquid secreted by mammals. As an agricultural product, milk is obtained from dairy farm animals such as cows, buffaloes, sheep, goats etc. which are raised as livestock. India is the leading producer of milk in the world, contributing 22% of global milk production according to Food and Agricultural Organisation, UN. However, a majority of the milk produced worldwide is contaminated with toxins.<sup>1</sup>

Mycotoxins are a group of secondary metabolites that are produced by fungi, that cause toxic effects in humans and animals. There are many classes of mycotoxins, including aflatoxins (AFB<sub>1</sub>, AFB<sub>2</sub>, AFG<sub>1</sub>, AFG<sub>2</sub>, AFM<sub>1</sub>), ochratoxin A, T2 toxin, zearalenone, citrinin, patulin etc.<sup>2</sup> Among all the mycotoxins, aflatoxins are the most commonly occurring ones in milk and milk products, and are of great interest and concern with regard to food safety. Aflatoxins are produced by the fungal species *Aspergillus flavus* and *Aspergillus parasiticus* during various stages of cereal grain production such as pre-harvest, post-harvest and storage of maize, corn, wheat, barley and oats.<sup>3</sup> These fungi produce aflatoxins in temperature conditions ranging between 12-48°C (optimal temperature being 36-38°C) and 3-18% moisture levels.<sup>4,5</sup>

Aflatoxin B<sub>1</sub> (AFB<sub>1</sub>) is the most potent mycotoxin. Animals consume livestock feed contaminated with AFB<sub>1</sub>, and it gets metabolized by the hepatic microsomal Cytochrome P450 enzymes<sup>6</sup> in the liver of ruminants to form the hydroxylated derivative aflatoxin M<sub>1</sub> (as shown in Fig.1)<sup>7</sup> which is secreted in the milk.<sup>4</sup> This carryover of AFB<sub>1</sub> to AFM<sub>1</sub> is reported to be higher during the early stages of lactation since higher levels of AFM<sub>1</sub> are observed in the milk during this time.<sup>8</sup>

AFB<sub>1</sub> and AFM<sub>1</sub> are categorized as class I and 2b human carcinogens respectively, by the International Agency for Research on Cancer.<sup>9</sup> However, following a recent reassessment by the IARC, the toxicity of AFM<sub>1</sub> has been updated from class 2b to 1, thereby establishing it as a certain human carcinogen.<sup>10</sup> Apart from their carcinogenicity, aflatoxins have hepatogenic, teratogenic, mutagenic and immunosuppressive effects on humans.<sup>11</sup> Although, the toxicity of AFM<sub>1</sub> is one-tenth that of AFB<sub>1</sub>.<sup>12</sup> The rate of conversion of AFB<sub>1</sub> into AFM<sub>1</sub> varies from 0.3% - 6.2%.<sup>13</sup> This conversion is governed by many factors including breed, health, diet and lactation stage of the animal.<sup>14</sup> It generally takes 2-3 days post the consumption of AFB<sub>1</sub> contaminated feeds, for AFM<sub>1</sub> to appear in secreted milk. Consequently, when the AFB<sub>1</sub> contaminated diets are stopped, it takes 2-3 days for the AFM<sub>1</sub> levels in milk to reduce to 0%.<sup>4</sup>

AFM<sub>1</sub> presence in milk is a worldwide concern, especially for infants and children whose diet largely depends on milk and dairy products, and thus they are most susceptible and vulnerable to the adverse effects of AFM<sub>1</sub>.<sup>15</sup> Furthermore, the implications of aflatoxin contamination of agricultural products are not limited to public health issues; its consequences affect the agricultural trade and economy of both developed and developing countries.<sup>16</sup>

Hence, this paper reviews the occurrence of aflatoxins in milk and milk products, detection methods, control and some decontamination strategies of aflatoxins.

## **2. OCCURRENCE OF AFLATOXINS IN MILK AND MILK PRODUCTS**

The occurrence of aflatoxins depends on many factors such as geography, climate, environmental factors and the type of food product. The riskiest geographical areas associated with aflatoxin contamination are those with a tropical or subtropical climate.<sup>4</sup> Many scientists have studied the effects of climatic conditions on aflatoxin occurrence. For instance, AFM<sub>1</sub> contamination was reported the highest in the rainy and winter seasons compared to summer and spring.<sup>17</sup> This was attributed to the fact that harvesting of crop grains is done in the rainy season which implies favourable conditions for the growth of toxin-producing fungi (temperature, humidity and moisture levels), thus imposing challenges in drying and storage of grains, resulting in increased aflatoxin contamination levels.<sup>18</sup>

The occurrence of aflatoxins has been reported in a variety of milk products, such as cheese, butter, yoghurt, ice-cream, breast milk and infant formulae.

### **2.1 Occurrence of aflatoxins in cheese**

Cheese is a popular dairy product consumed all over the world. However, there have been many reports of aflatoxin occurrence in cheese. Aflatoxin contamination in cheese can happen in more than one way: either by the carryover of AFB<sub>1</sub> from contaminated livestock feedstuffs to the AFM<sub>1</sub> in the raw milk used to make cheese, or the formation of aflatoxins by fungi *Aspergillus* growing on cheese.<sup>19</sup>

During the production of cheese from aflatoxin-contaminated milk, the AFM<sub>1</sub> gets concentrated in cheese. The concentration of aflatoxin is influenced by cheese processing, in that the AFM<sub>1</sub> concentration increases in the cheese curd. This was explained as aflatoxins having an affinity towards casein protein in milk, thus leading to preferential binding of AFM<sub>1</sub> with casein molecules. This association of AFM<sub>1</sub> with casein can be defined through the enrichment factor (EF) according to EC Regulation No. 1881/2006.<sup>20</sup> The biochemistry of cheese ripening involves the proteolysis of the casein proteins, which leads to the recovery of AFM<sub>1</sub>.<sup>4</sup> Although, there have been contrasting reports by authors regarding the distribution of AFM<sub>1</sub> between the whey and curd during the partitioning of AFM<sub>1</sub> in cheese manufacture. Allcroft and Carnaghan (1963) reported that 100% AFM<sub>1</sub> was found in cheese curd<sup>21</sup> whereas Purchase *et al.* (1972) reported 100% AFM<sub>1</sub> occurring in whey.<sup>22</sup>

There have been various reports of the occurrence levels of AFM<sub>1</sub> in cheese worldwide. Fallah *et al.* (2011) reported the mean level of AFM<sub>1</sub> in cheese as 0.085 µg/kg in Iran.<sup>23</sup> Similarly, the mean level of AFM<sub>1</sub> in cheese from Pakistan was reported as 0.189 µg/kg.<sup>24</sup> The AFM<sub>1</sub> levels in cheese ranged from 0.05 to 0.69 µg/kg in Turkey.<sup>25</sup>

### **2.2 Occurrence of aflatoxin in yoghurt**

Yoghurt is a fermentation product of milk, widely consumed by people across the world. But like all other milk products, yoghurt is contaminated with aflatoxins. When dairy products such as yoghurt is made from milk contaminated with AFM<sub>1</sub>, it results in yoghurt containing traces of AFM<sub>1</sub>. However, compared to cheese, the occurrence of AFM<sub>1</sub> was lower in yoghurt. A study on 120 samples of yoghurt in Iran reported the incidence of AFM<sub>1</sub> in 35 samples.<sup>26</sup>

The fermentation of yoghurt decreases the levels of AFM<sub>1</sub> present in milk, as reported by (Govaris *et al.* 2002).<sup>27</sup> The same study also reported the stability of AFM<sub>1</sub> during refrigerated storage, which was found to be more stable at pH 4.6 than pH 4.0. This decrease in stability can be attributed to low pH.<sup>27</sup>

The presence of probiotics in yoghurt may potentially decrease the AFM<sub>1</sub> content in the final product, since the probiotic bacteria (*Lactobacillus* and *Bifidobacterium* species) act as aflatoxin binders in milk, thus binding to AFM<sub>1</sub> and detoxifying it.<sup>28</sup>

### **2.3 Occurrence of aflatoxins in butter**

Butter is a dairy product made from the fat and protein compounds of churned cream. The level of aflatoxin concentration in butter depends on the level of AFM<sub>1</sub> contamination in the constituent milk from which it is made. Based on a study in Iran, the occurrence of AFM<sub>1</sub> in butter ranged from 0.0047-0.0167ppb, which is lower than the limit set by the Institute of Standards and Industrial Research of Iran (ISIRI) and also the Codex Alimentarius limit.<sup>29</sup> The same study reported that the AFM<sub>1</sub> levels were higher in winter when compared to the summer season, and significantly higher in urban regions than the rural regions of Iran. Another study in Iran involving 31 samples of butter reported that ~26% of the samples were positive for AFM<sub>1</sub>, and 9.6% of samples exceeded the ISIRI standard limit of 0.02ppb for AFM<sub>1</sub> in butter.<sup>30</sup> The processing of butter involves agitating

of cream, which leads to the dissociation of protein components from fat. Due to the affinity of AFM<sub>1</sub> towards the milk protein casein, the AFM<sub>1</sub> gets concentrated in the protein components thereby resulting in low levels of AFM<sub>1</sub> in the butter.<sup>31</sup> Similar to butter, the occurrence of AFM<sub>1</sub> was also detected in ghee sauce (Eshabwe) in western Uganda, at a level of 18.6±2.4 mg/kg.<sup>32</sup>

#### **2.4 Occurrence of aflatoxins in ice cream**

Ice cream is a frozen food product derived from milk or cream and is consumed as a dessert in many cultures around the world. There have been very few studies across the world reporting the occurrence of AFM<sub>1</sub> in ice cream. In a study conducted in Iran, the AFM<sub>1</sub> levels were estimated in ice cream samples (n=90), and it was reported that 62 of the samples tested AFM<sub>1</sub> positive with the concentrations of AFM<sub>1</sub> ranging from 0.0084-0.147ppb, while 12% of the samples contained AFM<sub>1</sub> levels beyond the permissible limits set by EU and Codex Alimentarius.<sup>33</sup> In another study from Northern Iran, 45 samples of ice cream were tested for the presence of AFM<sub>1</sub>, and 22.2% of them were reported to contain AFM<sub>1</sub> levels beyond the limits of EU, in concentrations ranging from 1.2-103 ng/L.<sup>34</sup> Another study in Abeokuta (South Nigeria) reported that samples of ice cream recorded high scores of 2.23ppb, which exceeds the regulatory limits set by the FDA and Codex Alimentarius.<sup>35</sup>

#### **2.5 Occurrence of aflatoxins in breast milk**

Due to the systemic nature of AFM<sub>1</sub>, the consumption of aflatoxin-contaminated food while breastfeeding leads to the translocation of aflatoxins into breast milk, which poses a serious concern for infants who are entirely dependent on breast milk for their nutrition.<sup>36</sup> There have been very few studies on the occurrence of aflatoxins in human breast milk. A study based in Jordan (Middle East) involving 80 samples of human breast milk recorded that the concentration of AFM<sub>1</sub> ranged between 9.71-137.18 ng/kg, with the mean concentration being 67.78 ng/kg, which was much higher than the permissible limit.<sup>37</sup> Based on a meta-analysis conducted in Iran, it was reported that the pooled prevalence of AFM<sub>1</sub> in human breast milk (n = 11) was lower than the EC standard limit (25 ng/l).<sup>38</sup>

A study based in Turkey tested 75 samples of breast milk for the presence of aflatoxins and reported that all samples tested positive for AFM<sub>1</sub> with levels ranging from 60.90-299.99ng/l, which is higher than the permissible limit set by Turkey and the European Union. In this study, 17.30% of the samples recorded relatively low levels of AFM<sub>1</sub> (60-79 ng/l), 32% of samples recorded moderate levels (80-99 ng/l), whereas almost 50% of the samples contained AFM<sub>1</sub> in the range of 100-150ng/l.<sup>39</sup> However, since there is no official limit for AFM<sub>1</sub> in human breast milk, it is difficult to regulate the aflatoxin levels in breast milk.

### **3. LEGISLATION**

The regulation of aflatoxins by imposing strict governmental control is the widely accepted method for the control of AFM<sub>1</sub> in milk products. Many countries across the world have set different maximum permissible limits for AFM<sub>1</sub> content in milk and milk products, which are summarized in **Table 1**.

The US Food and Drug Administration has set a maximum limit for AFM<sub>1</sub> as 0.5 µg/kg (ppb), whereas the Codex Alimentarius and European Community fixed the regulatory limit for AFM<sub>1</sub> as 0.05 ppb, while setting a lower limit for milk products intended for infants as 0.025ppb (Commission Regulation EC No. 1881/ 2006 of 19 December 2006). Following this, countries like Germany, Switzerland, Italy and Austria have also set their regulatory limits for AFM<sub>1</sub> as 0.05 ppb (as per the EU).<sup>28</sup> The European Union has the world's best food safety and surveillance system in the form of a tool known as the Rapid Alert System for Food and Feed (RASFF). This ensures the flow of information related to food safety hazards and enables the swift reaction to the risks detected in the food chain that might harm public health.<sup>52</sup> Though these regulatory limits are in place, it is difficult to control the intake of aflatoxins since the legal limits are a compromise between economical constraints and food safety concerns. At best, these regulatory limits serve as the last line of defense against exposure to aflatoxins.<sup>16</sup>

### **4. DETECTION METHODS OF AFM<sub>1</sub> IN MILK**

Owing to the extensive toxicity of aflatoxins, there have been various regulations implemented by governments of countries across the world. These regulations are based on the detection of aflatoxins in a variety of milk products, by applying a wide range of analytical methods. Many analytical methods have been developed and validated by scientists for the purpose of detection and quantification of aflatoxins in milk and milk products.

**The detection methods for AFM<sub>1</sub> can be generally classified into 3 types:**

1. Immunochemical methods
2. Chromatographic methods
3. Spectrometric methods

#### 4.1 IMMUNOCHEMICAL METHODS

Immunochemical methods are specific for each mycotoxin, due to the use of specific antibodies to recognize the mycotoxin.<sup>53</sup> Enzyme-linked immunosorbent assay (ELISA) is the most common immunochemical method used to measure AFM<sub>1</sub> levels in milk and milk products, due to its simplicity, affordability and ease of use.<sup>54</sup> Among the different types of ELISA, the indirect competitive mode of ELISA is widely used for mycotoxin detection.<sup>55</sup> A mono-clonal antibody-based indirect competitive ELISA was developed by Peng *et al.* (2016) for the determination of AFM<sub>1</sub> in milk.<sup>56</sup> The recovery rates for this assay ranged from 85.3-107.6%. The limit of detection (LOD) and limit of quantification (LOQ) were 27.5 and 35ng/L respectively. Despite its advantages, ELISA also has its demerits such as long incubation time, potential cross-reactivity, and several washing and mixing stages. Thus, there have been several modified versions of ELISA developed to overcome these limitations. To enhance the sensitivity and efficiency, Kanungo and Bhand (2013) developed an ELISA with fluorimetric detection, with AFM<sub>1</sub>-specific monoclonal antibodies and secondary conjugated antibodies in a 384-well microplate. AFM<sub>1</sub> was detected at 0.001ppb in a testing volume of 40µL.<sup>57</sup>

Immunosensors convert biological signals that arise from the interaction of an analyte and a bio-receptor, into electrical signals via a transducer detector element, which are further amplified and displayed on a system.<sup>58</sup> The most commonly used biosensors for aflatoxin detection are electrochemical and optical sensors.<sup>59</sup>

#### 4.2 CHROMATOGRAPHIC METHODS

Chromatographic techniques are widely used for the detection and quantification of aflatoxins from a variety of samples. The principle of using chromatography for aflatoxin detection is the separation of the sample solute between the stationary phase and the mobile phase. The most commonly used techniques for aflatoxin detection are gas chromatography (GC), liquid chromatography (LC), high-performance liquid chromatography (HPLC), thin layer chromatography (TLC), and high-performance thin layer chromatography (HPTLC).<sup>16</sup>

TLC is one of the oldest and simplest chromatographic methods for the screening and quantification of aflatoxins, which was widely used due to its simplicity, cost-effectiveness and its ability to detect multiple toxins.<sup>60</sup> TLC was applied for the identification of AFM<sub>1</sub> by reacting it with trifluoroacetic acid.<sup>61</sup> TLC official methods (AOAC methods 980.21 and 2008.08) have been used by authors for the analysis of AFM<sub>1</sub> contaminated milk products, obtaining low LOD values of 0.01 µg/kg.<sup>30,62</sup> In spite of its wide applications, TLC was prone to error in sample spotting.

To overcome the limitations of TLC, high-performance thin layer chromatography (HPTLC) was developed, which improves the accuracy and precision of TLC by auto-sampling and plate interpretation. The difference between TLC and the upgraded HP-TLC lies in the particles' size of the stationary phase, the sample application method and the data processing method.<sup>63</sup> HPTLC was used for the screening of AFM<sub>1</sub> levels in milk, with a detection limit of 0.1ng being achieved.<sup>64</sup>

Due to the development of other techniques such as liquid chromatography, TLC was outdated and abandoned by most laboratories. High-performance liquid chromatography (HPLC) is an advanced version of liquid chromatography technique, and is widely used for the detection and quantification of organic compounds.<sup>65</sup> HPLC is usually coupled with fluorescence detectors (HPLC-FLD) for the quantification of AFM<sub>1</sub> in milk, and it has shown high accuracy with LOD as low as 0.001 µg/kg and an average recovery of 90%.<sup>66</sup>

#### 4.3 Spectrometric methods

Spectrometric techniques have been widely used for food safety and quality evaluation, due to their advantages such as their non-destructive nature and minimum sample preparation. Some of the spectrometric methods used for aflatoxin detection include Fourier Transform Infrared spectroscopy (FTIR), Raman spectroscopy, hyperspectral imaging (HSI) and Nuclear Magnetic Resonance (NMR).<sup>67,68</sup>

Biancardi *et al.* (2013) coupled HPLC with tandem mass spectrometry (HPLC-MS/MS) and attached with electrospray ionisation (ESI) following liquid-liquid extraction, for AFM<sub>1</sub> analysis in milk, which was able to attain a LOQ of 0.015 µg/kg.<sup>69</sup> This combined the advantages of both HPLC (separation capability) to that of MS (sensitivity and specificity). Jaiswal *et al.* (2018) used FTIR spectroscopy equipped with attenuated total reflectance (ATR) for the detection of AFM<sub>1</sub> in milk.<sup>70</sup> Huang *et al.* (2014) developed a highly sensitive and rapid method for the simultaneous estimation of multi-mycotoxins such as AFM<sub>1</sub>, ochratoxin A and zearalenone in milk by using ultra-high performance liquid chromatography coupled with electrospray ionization in triple quadrupole tandem mass spectrometer (UHPLC-ESI-MS/MS). The LOQ for this method was in the range of 0.003-0.015 µg/kg, and recovery rates as high as 109%.<sup>71</sup>



Other advancements in the field of mass spectrometry include the development of a direct analysis through MS in real-time (DART), for the analysis of AFM<sub>1</sub> in cow milk. This method was able to achieve low calibration levels of 0.1 µg/kg, with recovery rates in the range of 94.7 - 109.2%.<sup>72</sup>

## 5. DECONTAMINATION METHODS OF AFLATOXINS

Due to their toxicity, aflatoxins are extensively monitored and regulated in many food products around the world. There have been numerous strategies proposed by scientists for the control and removal of aflatoxins from milk and milk products. Decontamination methods of aflatoxins can be classified into 3 types:

1. Physical methods
2. Chemical methods
3. Biological methods

### 5.1 PHYSICAL METHODS

The decontamination of aflatoxins might be achieved by using different physical methods, but they are often not as effective as chemical or biological methods of decontamination. There has been contrasting data on the efficiency of physical methods of AFM<sub>1</sub> decontamination. For instance, even though AFM<sub>1</sub> is heat stable, there have been studies reporting a reduction in AFM<sub>1</sub> levels due to heat treatment. Omeiza *et al.* (2018) reported a 59% reduction in AFM<sub>1</sub> levels in milk (with an initial concentration of 0.24 µg/kg) subjected to high-temperature treatment at 121°C for 15 mins.<sup>73</sup> This is in contrast with the findings of Prandini *et al.* (2009) who reported that AFM<sub>1</sub> is heat stable.<sup>4</sup> UV treatment is another technique for the reduction of AFM<sub>1</sub> milk. Yousef and Marth (1985) reported a 100% reduction in AFM<sub>1</sub> levels in milk at the initial level of 0.5 and 1 µg/L, by applying UV treatment at 365nm and adding hydrogen peroxide (0.05-1% H<sub>2</sub>O<sub>2</sub>) using a peristaltic pump for 60mins.<sup>74</sup> A study by Hassanpour *et al.* (2019) showed a 99% reduction in AFM<sub>1</sub> by exposing milk spiked with 0.063 µg/L to low-level gamma radiation doses of 0.39 mGy per day from radioactive granite for 8 days.<sup>75</sup>

### 5.2 CHEMICAL METHODS

Chemical methods of decontamination involve the use of chemical agents such as chlorinating agents, oxidizing and reducing agents, acids and bases for the reduction of aflatoxins in milk. Ammonia is extensively used for aflatoxin degradation since aflatoxins are unstable under alkaline conditions. The mechanism of decontamination by ammonia involves the opening of the lactone ring of AFM<sub>1</sub> due to hydrolysis, leading to the structural change of the AFM<sub>1</sub> molecule, and thus reducing its toxicity.<sup>76</sup> Ozone (O<sub>3</sub>) treatment is an FDA-approved method that is used for the decontamination of AFM<sub>1</sub> in food products such as milk. Due to its GRAS (Generally Regarded as Safe) status, high penetration ability, and rapid degradation of toxins into non-hazardous products, it can be used in many food products.<sup>77</sup>

The application of ozone treatment at 16mg/L for 5 mins was able to obtain a 50% reduction in AFM<sub>1</sub> levels in milk containing 0.56 µg/kg.<sup>78</sup> The mechanism of ozonation involves the electrophilic addition reaction with the C8-C9 double bond in the furan ring of aflatoxin, leading to the formation of primary ozonides and reformation of derivatives such as aldehydes, ketones and organic acids.<sup>79</sup> A study conducted by Mohammadi *et al.* (2017) showed that the degradation of AFM<sub>1</sub> with ozone was linear with the time exposure, and a 53% reduction of AFM<sub>1</sub> in milk was obtained in 10 mins.<sup>80</sup>

Some adsorbent clays and soils such as bentonite and hydrated sodium calcium aluminosilicate (HSCAS) are used for the adsorption of toxins from milk, without minimal changes to the nutritional composition of the milk. Bentonite was found effective in the reduction of AFM<sub>1</sub> in milk below the standard limits while its residues in the milk were almost negligible in quantity (0.4%), and had no significant effect on human health.<sup>81</sup> Another technique for AFM<sub>1</sub> decontamination was developed by Jouni *et al.* (2018) who used Fe<sub>3</sub>O<sub>4</sub> nanoparticles attached to specific aptamers, resulting in a 95% reduction in AFM<sub>1</sub> in milk artificially spiked with 0.1 µg/L AFM<sub>1</sub>.<sup>82</sup>

### 5.3 BIOLOGICAL METHODS

Biological methods of decontamination involve the use of microorganisms for the removal of aflatoxins from food products through mechanisms like surface adsorption, detoxification and inhibition.<sup>83</sup> These biological decontamination methods are environment-friendly and cost-effective and relatively less aggressive than other types of decontamination methods.<sup>16</sup> Prevention of fungal growth is a pre-emptive measure to avoid aflatoxin contamination, right from crop stage. This can be achieved by biological control via field inoculations with atoxigenic strains of *Aspergillus flavus*, thus leading to strategic suppression of toxigenic strains of the fungi that produce AFB<sub>1</sub> in crops like maize.<sup>84</sup> This was achieved by Hruska *et al.* (2014) who colonised the

aflatoxigenic *A. flavus* strain AF70 with a green fluorescent protein (GFP) in the presence of an atoxigenic strain AF36, and studied the competitive interaction between the strains. It was observed that the co-inoculation with AF36 strain suppressed the growth of AF70-GFP inside the kernel by 82%, which correspondingly suppressed the aflatoxin production by 73%.<sup>85</sup>

The concept of bio-decontamination involves the use of microorganisms in the binding of AFM<sub>1</sub> in milk, which in turn prevents the adsorption of the toxins in the small intestine and gets excreted. This is followed by applying membrane filters for the removal of AFM<sub>1</sub> bounded dead microbial cells from the milk.<sup>28</sup> Even though the exact mechanism of microbial binding with AFM<sub>1</sub> has not been established, the most proposed mechanism is the adhesion of AFM<sub>1</sub> to cell components such as polysaccharides and peptidoglycans in the cell wall of microbes, through non-covalent interactions.<sup>86</sup> Microorganisms such as lactic acid bacteria (LAB), *Bifidobacterium sp.*, and *Saccharomyces cerevisiae* have been used as aflatoxin binders in the decontamination of AFM<sub>1</sub> in milk and milk products. A combination of *S. cerevisiae* and a pool of LAB were found to exhibit a 100% binding capacity with AFM<sub>1</sub> in milk.<sup>87</sup> A combination of *Lactobacillus plantarum* (DSM 20079), *Lactobacillus acidophilus* (DSM 20079), *Bifidobacterium bifidum* (DSM 20082), *Kluyveromyces lactis* (CBS 2359) and *S. cerevisiae* (ATCC 64712) showed 90% of AFM<sub>1</sub> degradation in milk after an incubation period of 72hrs.<sup>88</sup> It was generally observed that using heat-killed bacterial strains was more effective than viable bacterial cells in the reduction of AFM<sub>1</sub> levels in milk.<sup>89</sup> Kuharić *et al.* (2018) developed a method involving refrigeration at 4°C with heat-treated *Lactobacillus plantarum* KM followed by centrifugation and filtration, which resulted in a 95% reduction in AFM<sub>1</sub> levels in milk.<sup>90</sup> Assaf *et al.* (2019b) demonstrated that AFM<sub>1</sub> contaminated milk may be passed through bio-films composed of *Lactobacillus rhamnosus* for the removal of AFM<sub>1</sub>, which led to a 60.74% reduction in AFM<sub>1</sub> levels after AFM<sub>1</sub> spiked milk samples were passed through 10 plates of biofilms for 30 seconds each.<sup>91</sup>

Aflatoxins are present in many food products throughout the world. Despite the research knowledge generated about it, it remains to be a significant threat to food safety worldwide. The only widely accepted control measure for aflatoxins is the strict regulation and monitoring of aflatoxin levels by governments and legislative bodies of developing countries. In order to mitigate the occurrence of aflatoxins, it is important to focus on the root cause of the problem, i.e, fungal growth on the crops and feedstuff and subsequent contamination with AFB<sub>1</sub>. Implementation of GAPS, GMPs, HACCP, and proper handling and storage of food grains and products could be effective in reducing the risk of contamination. Future research on novel decontamination strategies of aflatoxin is required to tackle this issue in the long run. Moreover, a better understanding of the exact mechanism of AFM<sub>1</sub> with microbial cells could open more avenues for the effective decontamination of food products. At the same time, the safety aspects of using microorganisms as decontamination strategies should be validated before commercial use.

#### ABBREVIATIONS USED

AFB<sub>1</sub>, Aflatoxin B<sub>1</sub>; AFM<sub>1</sub>, Aflatoxin M<sub>1</sub>, IARC, International Agency for Research on Cancer; EF, Enrichment factor; EU, European Union; ISIRI, Institute of Standards and Industrial Research of Iran; FDA, Food and Drug Administration; RASFF, Rapid Alert System for Food and Feed; ELISA, Enzyme-linked immunosorbent assay, LOD, Limit of detection; LOQ, Limit of quantification; GC, Gas chromatography; LC, Liquid chromatography; HPLC, High-performance liquid chromatography; TLC, Thin layer chromatography; HPTLC, High-performance thin layer chromatography; AOAC, Association of Official Agricultural Chemists; FTIR, Fourier transform infrared spectroscopy; HSI, Hyper-spectral imaging; NMR, Nuclear magnetic resonance; ESI, Electrospray ionisation; MS, Mass spectroscopy; UHPLC, Ultra high-performance liquid chromatography; DART, Direct analysis in real time; UV, Ultraviolet; WHO, World Health Organization; FAO, Food and Agricultural Organization; GRAS, Generally regarded as safe; HSCAS, Hydrated sodium calcium aluminosilicate; GFP, Green fluorescent protein; LAB, Lactic acid bacteria; GAP, Good agricultural practices; GMP, Good manufacturing practices; HACCP, Hazard analysis critical control point.

#### CONFLICT OF INTEREST

The authors declare no conflict of interest.

#### ACKNOWLEDGEMENTS

The authors would like to thank the Department of Food Process Engineering, SRM Institute of Science and Technology, Kattankulathur and the Pharmacovigilance Laboratory for Animal Feed and Food Safety, Tamil Nadu Veterinary and Animal Sciences University, Chennai for their guidance and support.

---

---

**REFERENCES**

1. Winckel, M.; Velde, S.; Bruyne, R.; Biervliet, S.; Van Winckel, M.; Vande Velde, S.; De Bruyne, R.; Van Biervliet, S. Clinical practice: vegetarian infant and child nutrition. *Eur. J. Pediatr.* 2011, 170, 1489-1494.
2. Ketney, O.; Santini, A.; Oancea, S. Recent aflatoxin survey data in milk and milk products: A review. *Int. J. Dairy Technol.* 2017, 70, 320-331.
3. Pitt, J. I.; Taniwaki, M. H.; Cole, M. B. Mycotoxin production in major crops as influenced by growing, harvesting, storage and processing, with emphasis on the achievement of Food Safety Objectives. *Food control.* 2013, 32, 205-215.
4. Prandini, A.; Tansini, G. I. N. O.; Sigolo, S.; Filippi, L. A. U. R. A.; Laporta, M.; Piva, G. On the occurrence of aflatoxin M1 in milk and dairy products. *Food Chem. Toxicol.* 2009, 47, 984-991.
5. Duncan, H. E.; Hagler Jr, W. M. Aflatoxins and other mycotoxins. Oklahoma Cooperative Extension Service, 1989.
6. Paniel, N.; Radoi, A.; Marty, J. L. Development of an electrochemical biosensor for the detection of aflatoxin M1 in milk. *Sensors.* 2010, 10, 9439-9448.
7. Womack, E. D.; Sparks, D. L.; Brown, A. E. Aflatoxin M1 in milk and milk products: a short review. *World Mycotoxin J.* 2016, 9, 305-315.
8. Veldman, A.; Meijs, J. A. C.; Borggreve, G. J.; Heeres-Van Der Tol, J. J. Carry-over of aflatoxin from cows' food to milk. *Anim. Sci.* 1992, 55, 163-168.
9. Iqbal, S. Z.; Asi, M. R.; Selamat, J. Aflatoxin M1 in milk from urban and rural farmhouses of Punjab, Pakistan. *Food Addit. Contam., Part B.* 2014, 7, 17-20.
10. Pecorelli, I.; Branciarri, R.; Roila, R.; Bibi, R.; Ranucci, D.; Onofri, A.; Valiani, A. Evaluation of Aflatoxin M1 Enrichment Factor in Semihard Cow's Milk Cheese and Correlation with Cheese Yield. *J. Food Prot.* 2019, 82, 1176-1182.
11. Benkerroum, N. Chronic and acute toxicities of aflatoxins: Mechanisms of action. *Int. J. Environ. Res. Public Health.* 2020, 17, 423.
12. Wogan, G. N.; Paglialonga, S. Carcinogenicity of synthetic aflatoxin M1 in rats. *Food Cosmet. Toxicol.* 1974, 12, 381-384.
13. Creppy, E. E. Update of survey, regulation and toxic effects of mycotoxins in Europe. *Toxicol. Lett.* 2002, 127, 19-28.
14. Duarte, S. C.; Almeida, A. M.; Teixeira, A. S.; Pereira, A. L.; Falcão, A. C.; Pena, A.; Lino, C. M. Aflatoxin M1 in marketed milk in Portugal: Assessment of human and animal exposure. *Food Control.* 2013, 30, 411-417.
15. Sadia, A.; Jabbar, M. A.; Deng, Y.; Hussain, E. A.; Riffat, S.; Naveed, S.; Arif, M. A survey of aflatoxin M1 in milk and sweets of Punjab, Pakistan. *Food control.* 2012, 26, 235-240.
16. Jallow, A.; Xie, H.; Tang, X.; Qi, Z.; Li, P. Worldwide aflatoxin contamination of agricultural products and foods: From occurrence to control. *Compr. Rev. Food Sci. Food Saf.* 2021, 20, 2332-2381.
17. Ruangwises, S.; Ruangwises, N. Occurrence of aflatoxin M1 in pasteurized milk of the school milk project in Thailand. *J. Food Prot.* 2009, 72, 1761-1763.
18. Tanboon-ek, P. Control of aflatoxin in maize. *Mycotoxin Prevention and Control in Food Grains.* FAO, Rome, Italy, 1989, 166-172.
19. Zerfiridis, G. K. Potential aflatoxin hazards to human health from direct mold growth on Teleme cheese. *J. Dairy Sci.* 1985, 68, 2184-2188.
20. Pecorelli, I.; Branciarri, R.; Ortenzi, R.; Ciriacci, M.; Checcarelli, S.; Roila, R.; Capotorti, A.; Spaccini, G.; Valiani, A. Evaluation of the concentration factor of aflatoxin M1 in a semi-hard Pecorino cheese obtained from naturally contaminated milk. *Food Control.* 2018, 85, 194-198.
21. Allcroft, R.; Carnaghan, R. B. A. Groundnut toxicity: an examination for toxin in human food products from animals fed toxic groundnut meal. *Vet. Rec.* 1963, 75, 259-263.

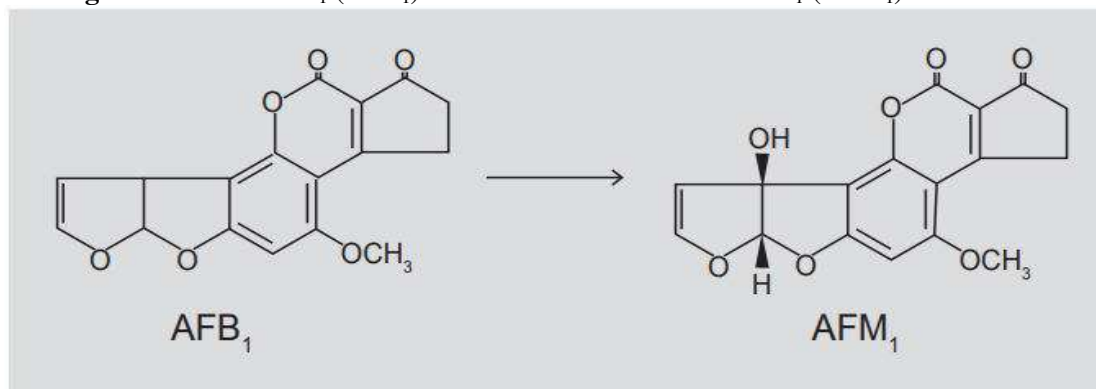
22. Purchase, I. F. H.; Steyn, M.; Rinsma, R.; Tustin, R. C. Reduction of the aflatoxin M content of milk by processing. *Food Cosmet. Toxicol.* 1972, 10, 383-387.
23. Fallah, A. A.; Rahnama, M.; Jafari, T.; Saei-Dehkordi, S. S. Seasonal variation of aflatoxin M1 contamination in industrial and traditional Iranian dairy products. *Food Control.* 2011, 22, 1653-1656.
24. Iqbal, S. Z.; Asi, M. R. Assessment of aflatoxin M1 in milk and milk products from Punjab, Pakistan. *Food Control.* 2013, 30, 235-239.
25. Tekinşen, K. K., Eken, H.S. Aflatoxin M1 levels in UHT milk and kashar cheese consumed in Turkey. *Food Chem. Toxicol.* 2008, 46, 3287-3289.
26. Nilchian, Z.; Rahimi, E. Aflatoxin M1 in yoghurts, cheese and ice-cream in Shahrekord-Iran. *World Appl. Sci. J.* 2012, 19, 621-624.
27. Govaris, A.; Roussi, V.; Koidis, P. A.; Botsoglou, N. A. Distribution and stability of aflatoxin M1 during production and storage of yoghurt. *Food Addit. Contam.* 2002, 19, 1043-1050.
28. Ismail, A.; Akhtar, S.; Levin, R. E.; Ismail, T.; Riaz, M.; Amir, M. Aflatoxin M1: Prevalence and decontamination strategies in milk and milk products. *Crit. Rev. Microbiol.* 2016, 42, 418-427.
29. Sohrabi, N.; Gharahkoli, H. A seasonal study for determination of aflatoxin M1 level in dairy products in Iranshahr, Iran. *Curr Med Mycol.* 2016, 2, 27-31.
30. Fallah, A. A. Aflatoxin M1 contamination in dairy products marketed in Iran during winter and summer. *Food control.* 2010b, 21, 1478-1481.
31. Yousef, A. E.; Marth, E. H. Stability and degradation of aflatoxin M1. *Mycotoxins in Dairy Products.* Hans P. Van Egmond (Ed.) Elsevier Applied Science, London and New York. 1989, 127-161.
32. Kitya, D.; Bbosa, G. S.; Mulogo, E. Aflatoxin levels in common foods of South Western Uganda: a risk factor to hepatocellular carcinoma. *Eur. J. Cancer Care.* 2010, 19, 516-521.
33. Kazemi Darsanaki, R.; Azizollahi Aliabadi, M.; Mohammad Doost Chakoosari, M. Aflatoxin M1 contamination in ice-cream. *J. Chem. Health Risks.* 2013, 3.
34. Khoshnevis, S. H.; Gholampour Azizi, I.; Shateri, S.; Mousavizadeh, M. Determination of the aflatoxin M1 in ice cream in Babol City (Northern, Iran). *Global Vet.* 2012, 8, 205-208.
35. Atanda, O.; Oguntubo, A.; Adejumo, O.; Ikeorah, J.; Akpan, I. Aflatoxin M1 contamination of milk and ice cream in Abeokuta and Odeda local governments of Ogun State, Nigeria. *Chemosphere.* 2007, 68, 1455-1458.
36. Ghiasian, S. A.; Maghsood, A. H.; Neyestani, T. R.; Mirhendi, S. H. Occurrence of aflatoxin M1 in raw milk during the summer and winter seasons in Hamedan, Iran. *J. Food Saf.* 2007, 27, 188-198.
37. Omar, S. S. Incidence of aflatoxin M1 in human and animal milk in Jordan. *J. Toxicol. Environ. Health, Part A.* 2012, 75, 1404-1409.
38. Fakhri, Y.; Ghorbani, R.; Taghavi, M.; Keramati, H.; Amanidaz, N.; Moradi, B.; Nazari, S. H.; Shariatifar, N.; Khaneghah, A. M. Concentration and prevalence of aflatoxin M1 in human breast milk in Iran: Systematic review, meta-analysis, and carcinogenic risk assessment: A review. *J. Food Prot.* 2019, 82, 785-95.
39. Gürbay, A. Y. L. İ. N.; Sabuncuoğlu, S. A.; Girgin, G. Ö. Z. D. E.; Şahin, G. İ. Z. E. M.; Yiğit, Ş. U. L. E.; Yurdakök, M. U. R. A. T.; Tekinalp, G. Ü. L. S. E. V. İ. N. Exposure of newborns to aflatoxin M1 and B1 from mothers' breast milk in Ankara, Turkey. *Food Chem. Toxicol.* 2010, 48, 314-319.
40. Xiong, J. L.; Wang, Y. M.; Ma, M. R.; Liu, J. X. Seasonal variation of aflatoxin M1 in raw milk from the Yangtze River Delta region of China. *Food control.* 2013, 34, 703-706.
41. European Union Commission Regulation (EC) No 1881/2006 of 19 December 2006 setting maximum levels for certain contaminants in foodstuffs. In Reg. CE. 1881/2006. Commission, E ed. Bruxelles: European Union, 1998-2014.

42. Siddappa, V.; Nanjegowda, D. K.; Viswanath, P. Occurrence of aflatoxin M1 in some samples of UHT, raw & pasteurized milk from Indian states of Karnataka and Tamilnadu. *Food Chem. Toxicol.* 2012, 50, 4158-62.
43. Galvano, F.; Galofaro, V.; Galvano, G. Occurrence and stability of aflatoxin M1 in milk and milk products: a worldwide review. *J. Food Prot.* 1996, 59, 1079-1090.
44. Han, R. W.; Zheng, N.; Wang, J. Q.; Zhen, Y. P.; Xu, X. M.; Li, S. L. Survey of aflatoxin in dairy cow feed and raw milk in China. *Food control.* 2013, 34, 35-39.
45. Sani, A. M.; Nikpooyan, H.; Moshiri, R. Aflatoxin M1 contamination and antibiotic residue in milk in Khorasan province, Iran. *Food Chem. Toxicol.* 2010, 48, 2130-2132.
46. Mohajeri, F. A.; Ghalebi, S. R.; Rezaeian, M.; Gheisari, H. R.; Azad, H. K.; Zolfaghari, A.; Fallah, A. A. Aflatoxin M1 contamination in white and Lighvan cheese marketed in Rafsanjan, Iran. *Food control.* 2013, 33, 525-527.
47. Bakirci, I. A study on the occurrence of aflatoxin M1 in milk and milk products produced in Van province of Turkey. *Food control.* 2001, 12, 47-51.
48. Sarimehmetoğlu, B.; Küplülü, Ö. Binding ability of aflatoxin M1 to yoghurt bacteria. *Ankara Univ. Vet. Fak. Derg.* 2004, 51, 195-198.
49. Zinedine, A.; González-Osnaya, L.; Soriano, J. M.; Moltó, J. C.; Idrissi, L.; Manes, J. Presence of aflatoxin M1 in pasteurized milk from Morocco. *Int. J. Food Microbiol.* 2007, 114, 25-29.
50. Ismail, A.; Gonçalves B. L.; de Neeff, D. V.; Ponzilacqua, B.; Coppa, C. F.; Hintzsche, H.; Sajid, M.; Cruz, A. G.; Corassin, C. H.; Oliveira, C. A. Aflatoxin in foodstuffs: Occurrence and recent advances in decontamination. *Food Res. Int.* 2018, 113, 74-85.
51. Negash, D. A review of aflatoxin: occurrence, prevention, and gaps in both food and feed safety. *J. Appl Microb Res.* 2018, 1, 35-43.
52. Parisi, S.; Barone, C.; Sharma, R. K. *Chemistry and Food safety in the EU: The Rapid Alert System for Food and Feed (RASFF)*. Springer. 2016.
53. Zheng, M. Z.; Richard, J. L.; Binder, J. A review of rapid methods for the analysis of mycotoxins. *Mycopathologia.* 2006, 161, 261-273.
54. Shephard, G.S.; Berthiller, F.; Burdaspal, P. A.; Crews, C.; Jonker, M. A.; Krska, R.; Lattanzio, V. M.; MacDonald, S.; Malone, R. J.; Maragos, C.; Sabino, M. Developments in mycotoxin analysis: an update for 2011-2012. *World Mycotoxin J.* 2013, 6, 3-30.
55. Nolan, P.; Auer, S.; Spehar, A.; Elliott, C. T.; Campbell, K. Current trends in rapid tests for mycotoxins. *Food Addit. Contam., Part A.* 2019, 36, 800-814.
56. Peng, D.; Yang, B.; Pan, Y.; Wang, Y.; Chen, D.; Liu, Z.; Yang, W.; Tao, Y.; Yuan, Z. Development and validation of a sensitive monoclonal antibody-based indirect competitive enzyme-linked immunosorbent assay for the determination of the aflatoxin M1 levels in milk. *Toxicon.* 2016, 113, 18-24.
57. Kanungo, L.; Bhand, S. Fluorimetric immunoassay for multianalysis of aflatoxins. *J. Anal. Methods Chem.* 2013, 1-8.
58. Ricci, F.; Volpe, G.; Micheli, L.; Palleschi, G. A review on novel developments and applications of immunosensors in food analysis. *Anal. Chim. Acta.* 2007, 605, 111-129.
59. Mottram, T.; Velasco-Garcia, M.; Berry, P.; Richards, P.; Ghesquiere, J.; Masson, L. Automatic on-line analysis of milk constituents (urea, ketones, enzymes and hormones) using biosensors. *Comp. Clin. Pathol.* 2002, 11, 50-58.
60. Măruțoiu, C.; Puiu, S.; Moise, M. I.; Soran, L.; Măruțoiu, O. F.; Boboș, L. Optimization of the separation of some aflatoxins by thin-layer chromatography. *J. Planar Chromatogr. - Mod. TLC.* 2004, 17, 372-374.
61. Li, W.; Xu, K.; Xiao, R.; Yin, G.; Liu, W. Development of an HPLC-based method for the detection of aflatoxins in Pu-erh tea. *Int. J. Food Prop.* 2015, 18, 842-848.

62. Kafle, P.; Sedai, D.; Rai, K. P.; Pokharel, B. B. Study on the level of aflatoxin M1 contamination in raw and processed milk marketed in Kathmandu Valley. *J. Food Sci. Technol. Nepal.* 2012, 7, 52-56.
63. Espinosa-Calderón, A.; Contreras-Medina, L. M.; Muñoz-Huerta, R. F.; Millán-Almaraz, J. R.; González, R. G. G.; Torres-Pacheco, I. Methods for detection and quantification of aflatoxins. *Aflatoxins: detection, measurement and control.* New York: InTech, 2011, 109-128.
64. Scussel, V. M. Comparison of methods by TLC and HPTLC for determination of aflatoxin M1 in milk and B1 in eggs. *Food Sci. Technol.* 2003, 23, 46-52.
65. Li, P.; Zhang, Q.; Zhang, D.; Guan, D.; Liu, D.X.; Fang, S.; Wang, X.; Zhang, W. Aflatoxin measurement and analysis. *IntechOpen.* 2011, 183-208.
66. Manetta, A. C.; Di Giuseppe, L.; Giammarco, M.; Fusaro, I.; Simonella, A.; Gramenzi, A.; Formigoni, A. High-performance liquid chromatography with post-column derivatisation and fluorescence detection for sensitive determination of aflatoxin M1 in milk and cheese. *J. Chromatogr. A.* 2005, 1083, 219-222.
67. Boyaci, I. H.; Temiz, H.T.; Geniş, H.E.; Soykut, E.A.; Yazgan, N. N.; Güven, B.; Uysal, R. S.; Bozkurt, A. G.; İlaslan, K.; Torun, O.; Şeker, F. C. Dispersive and FT-Raman spectroscopic methods in food analysis. *RSC Adv.* 2015, 5, 56606-56624.
68. De Saeger, S. (Ed.). *Determining mycotoxins and mycotoxigenic fungi in food and feed.* Elsevier. 2011.
69. Biancardi, A.; Piro, R.; Dall'Asta, C.; Galaverna, G. A simple and reliable liquid chromatography-tandem mass spectrometry method for the determination of aflatoxin M1 in milk. *Food Addit. Contam., Part A.* 2013, 30, 381-388.
70. Jaiswal, P.; Jha, S. N.; Kaur, J.; Borah, A.; Ramya, H. G. Detection of aflatoxin M1 in milk using spectroscopy and multivariate analyses. *Food Chem.* 2018, 238, 209-214.
71. Huang, L. C.; Zheng, N.; Zheng, B. Q.; Wen, F.; Cheng, J. B.; Han, R. W.; Xu, X. M.; Li, S. L.; Wang, J. Q. Simultaneous determination of aflatoxin M1, ochratoxin A, zearalenone and  $\alpha$ -zearalenol in milk by UHPLC-MS/MS. *Food Chem.* 2014, 146, 242-249.
72. Busman, M.; Bobell, J. R.; Maragos, C. M. Determination of the aflatoxin M1 (AFM1) from milk by direct analysis in real time-mass spectrometry (DART-MS). *Food Control.* 2015, 47, 592-598.
73. Omeiza, G. K.; Mwanza, M.; Enem, S. I.; Godwin, E.; Adeiza, M. A.; Okoli, C. Reducing efficiencies of the commonly used heat treatment methods and fermentation processes on aflatoxin M1 in naturally contaminated fresh cow milk. *Open J. Vet. Med.* 2018, 8, 134.
74. Yousef, A. E.; Marth, E. H. Degradation of aflatoxin M1 in milk by ultraviolet energy. *J. Food Prot.* 1985, 48, 697-698.
75. Hassanpour, M.; Rezaie, M. R.; Baghizadeh, A. Practical analysis of aflatoxin M1 reduction in pasteurized Milk using low dose gamma irradiation. *J. Environ. Health Sci. Eng.* 2019, 17, 863-872.
76. Moerck, K. E.; Mcelfresh, P.; Wohlman, A.; Hilton, B. W. Aflatoxin destruction in corn using sodium bisulfite, sodium hydroxide and aqueous ammonia. *J. Food Prot.* 1980, 43, 571-574.
77. Karaca, H.; Velioglu, Y. S. Ozone applications in fruit and vegetable processing. *Food Rev. Int.* 2007, 23, 91-106.
78. de Jesus Benevides, C. M.; da Cunha Veloso, M. C.; de Paula Pereira, P. A.; de Andrade, J. B. A chemical study of  $\beta$ -carotene oxidation by ozone in an organic model system and the identification of the resulting products. *Food Chem.* 2011, 126, 927-934.
79. Proctor, A. D.; Ahmedna, M.; Kumar, J. V.; Goktepe, I. Degradation of aflatoxins in peanut kernels/flour by gaseous ozonation and mild heat treatment. *Food Addit. Contam.* 2004, 21, 786-793.
80. Mohammadi, H.; Mazloomi, S. M.; Eskandari, M. H.; Aminlari, M.; Niakousari, M. The effect of ozone on aflatoxin M1, oxidative stability, carotenoid content and the microbial count of milk. *Ozone: Sci. Eng.* 2017, 39, 447-453.

81. Carraro, A.; De Giacomo, A.; Giannossi, M. L.; Medici, L.; Muscarella, M.; Palazzo, L.; Quaranta, V.; Summa, V.; Tateo, F. Clay minerals as adsorbents of aflatoxin M1 from contaminated milk and effects on milk quality. *Appl. Clay Sci.* 2014, 88, 92-99.
82. Javani Jouni, F.; Zafari, J.; Abdolmaleki, P.; Vazini, H.; Ghandi, L.; Satari, M. Aflatoxin M1 detoxification from infected milk using Fe<sub>3</sub>O<sub>4</sub> nanoparticles attached to specific aptamer. *J. Nanostruct. Chem.* 2018, 8, 13-22.
83. Tian, F.; Chun, H. S. Natural products for preventing and controlling aflatoxin contamination of food. In *Aflatoxin-Control, Analysis, Detection and Health Risks*; Abdulla'uf, L., Ed. 2017, 13-44.
84. Shan, X.; Williams, W. P. Toward elucidation of genetic and functional genetic mechanisms in corn host resistance to *Aspergillus flavus* infection and aflatoxin contamination. *Front. Microbiol.* 2014, 5, 364.
85. Hruska, Z.; Rajasekaran, K.; Yao, H.; Kinkaid, R.; Darlington, D.; Brown, R. L.; Bhatnagar, D.; Cleveland, T. E. Co-inoculation of aflatoxigenic and non-aflatoxigenic strains of *Aspergillus flavus* to study fungal invasion, colonization, and competition in maize kernels. *Front. Microbiol.* 2014, 5, 122.
86. Bovo, F.; Corassin, C. H.; Rosim, R. E.; de Oliveira, C. A. Efficiency of lactic acid bacteria strains for decontamination of aflatoxin M1 in phosphate buffer saline solution and in skimmed milk. *Food Bioprocess Technol.* 2013, 6, 2230-2234.
87. Corassin, C. H.; Bovo, F.; Rosim, R. E.; Oliveira, C. Efficiency of *Saccharomyces cerevisiae* and lactic acid bacteria strains to bind aflatoxin M1 in UHT skim milk. *Food control.* 2013, 31, 80-83.
88. Abdelmotilib, N. M.; Hamad, G. M.; Elderea, H. B.; Salem, E. G.; El Sohaimy, S. A. Aflatoxin M1 reduction in milk by a novel combination of probiotic bacterial and yeast strains. *European J. Nutr. Food Saf.* 2018, 8, 83-99.
89. Assaf, J. C.; Atoui, A.; Khoury, A. E.; Chokr, A.; Louka, N. A comparative study of procedures for binding of aflatoxin M1 to *Lactobacillus rhamnosus* GG. *Braz. J. Microbiol.* 2018, 49, 120-127.
90. Kuharić, Ž.; Jakopović, Ž.; Čanak, I.; Frece, J.; Bošnjir, J.; Pavlek, Ž.; Ivešić, M.; Markov, K. Removing aflatoxin M1 from milk with native lactic acid bacteria, centrifugation, and filtration. *Arh Hig Rada Toksikol.* 2018, 69, 334-339.
91. Assaf, J. C.; Khoury, A. E.; Chokr, A.; Louka, N.; Atoui, A. A novel method for elimination of aflatoxin M1 in milk using *Lactobacillus rhamnosus* GG biofilm. *Int. J. Dairy Technol.* 2019, 72, 248-256.

**Figure 1.** Aflatoxin B<sub>1</sub> (AFB<sub>1</sub>) is metabolised into aflatoxin M<sub>1</sub> (AFM<sub>1</sub>) in the liver.<sup>7</sup>



**Table 1.** Regulatory limits for AFM1 in milk and milk products

Country	Maximum permissible limit <sup>a</sup> ppb (or) µg/kg	Type of product	Reference
US FDA	0.50	Milk	[2]
Codex Alimentarius	0.05	Milk	[2]
China	0.50	Milk	[40]
European Union	0.05	Milk	[41]
	0.25	Cheese	
India	0.50	Milk	[42]
Germany	0.05	Milk	[43]
Switzerland	0.05	Milk	[43]

Italy	0.05	Milk	[43]
Austria	0.05	Milk	[43]
Japan	0.50	Milk	[44]
Iran	0.05	Milk	[45]
	0.20	Cheese	[46]
	0.02	Butter	[30]
	0.05	Yoghurt	[30]
	0.05	Ice cream	[30]
Turkey	0.05	Milk	[47]
	0.025	Cheese	[48]
Morocco	0.05	Milk	[49]
Chile	10	Milk	[50]
Australia	0.02	Children's milk	[51]
Czech Republic	0.1	Children's milk	[51]
	0.5	Adult's milk	[51]

<sup>a</sup>ppb = parts per billion (or) microgram per kilogram



## Comparison of Job Satisfaction among Male and Female Government College Teachers in Imphalwest District, Manipur

Tayenjam Kanta Singh and Ch. Beda Devi

Department of Education, Manipur University, Canchipur, India

### ABSTRACT

Today the satisfaction of college teachers increases productivity and classroom performance in the college effectively. Job satisfaction is very important because most of the teachers spend a major portion of their life at their workplace i.e. college. It is not only for the teachers but also for the students and non-teaching staff. Therefore, the main purpose of the study was to find out the levels of job satisfaction among male and female Government college teachers in Imphal West district, Manipur. The sample for the study consisted of 100 Government college teachers selected based on a simple random sampling i.e. Assistant Professors and Associate Professors in Imphal College and Oriental College. In the study, a standardized Questionnaire of Teacher's Job Satisfaction Scale TJSS developed by Yudhivendra Mudgil, Prof. I.S. Mubar, Prabha Bhatia (2012) was used to collect the data and applied with some statistical techniques like z scores norms analysis, mean, standard deviation and t-test to analyze the data. The analysis of the study revealed that the majority of Government college teachers of Imphal West District are found under moderate/average level of job satisfaction in Grade D. However, the percentage of the female teacher is more than male teachers. There is a significant difference between male and female teachers in their job working hours and a positive degree of high correlation between educational qualification and job satisfaction among male and female teachers. Therefore, the expectations of college teachers depend upon the successful running of the higher education system. Satisfaction of teachers is the result of teachers' perception of how well their job provides those things that are valuable to their life struggles.

Keywords: Job satisfaction, Government College, Teachers, Male, Female

### I. INTRODUCTION

Job satisfaction of teachers refers to a collection of positive or negative feelings that an individual holds towards his or her job. Teachers are the source of guidance in all the crucial steps in the academic life of the students. Quality in teaching and learning can only be enhanced if the faculty members are satisfied (Chen et. al., 2006) and the efficiency and condition of an educational institution depend upon the job satisfaction of teachers (Wood, 1976). It differs from person to person and institution to institution even in the context of males and females.

When teachers are satisfied with their job they can contribute a lot to the well-being of their pupils and perform their responsibilities with more concentration and devotion, they are more energetic, innovative, and productive. Trabue (1993) suggested that profound satisfaction is the actual return of a teacher and if a teacher is satisfied in all dimensions he or she can turn up to the public expectations. When teachers are satisfied with the job, they can perform better and better for the well-being of human resources. But teachers who are unsatisfied with their positions may not perform to the best of their capabilities. Shetty & Gujarathi (2012) observed that faculty members have been somewhat satisfied with the teaching climate and they have not been much satisfied with participation in decision making and freedom to choose subjects to be taught. Job dissatisfaction leads to a reduced level of performance (Bretz & Thomas, 1992).

Job satisfaction among college teachers is good not only for themselves but for society as a whole. The importance of higher education is needed for the development of a society and can hardly be over-emphasized. Job satisfaction is a multidimensional concept and it implies the attitude of a person towards various facets of his or her job. Hoppock (1995) defined "job satisfaction as any combination of psychological, physiological, and environmental circumstances that cause a person truthfully to say that he/she has been satisfied with the job".

Job satisfaction in this context is the ability of the teaching job to meet teachers' needs and improve their job performance. Knowledge, skills, and competencies occur when one feels satisfied with one's behavior. Therefore, satisfaction is needed in the behavior of college teachers to perform productive activities in the colleges. Job satisfaction is a pleasurable positive emotional state, resulting from the appraisal of one's job or job experiences. It results from the perception that one's job fulfills or allows the fulfillment of one's important job values, providing and to the degree that these values are congruent with one's needs (Locke, 1976).

The status of job satisfaction of Government college teachers among males and females in district-wise become an important challenging issue in Manipur. Particularly in the Imphal West district, it is required to know that most of the male or female college teachers are equal or less in their job in satisfaction level, working hours, and educational qualification in the present days. Thus the degree of satisfaction of teachers with their job cannot be determined. But in reality how far such job satisfaction is ensured in college teachers. When teachers are satisfied with their job they can perform their responsibilities with more sincerity and devotion to students and society.

## II. REVIEW OF LITERATURE

**Dr. Ms. Pabla (2012)** conducted a study on job satisfaction among teachers of Professional Colleges in Punjab. The main objectives of the study were: (i) to analyze the job satisfaction level of male and female teachers of Professional Colleges of Punjab Technical University, Jalandhar, and (ii) to study and compare the difference in job satisfaction levels of teachers teaching in the Professional colleges located in urban and rural areas of Punjab under PTU, Jalandhar. The hypotheses of the study were: (i) there was no significant difference in job satisfaction of male and female teachers of professional colleges and (ii) there was no significant difference in job satisfaction level of teachers teaching in professional colleges located in urban and rural areas. The study was descriptive. The total sample was restricted to 300 teachers from the professional colleges of Punjab under the jurisdiction of Punjab Technical University, Jalandhar. Convenient-purposive and random sampling techniques had been used for the study. The data was collected through a questionnaire method. The study revealed that there was a significant difference in the satisfaction level of male and female teachers of the professional colleges located under the jurisdiction of Punjab Technical University, Jalandhar. Female teachers were not very much satisfied with their job. On the other hand, male teachers seemed to be more satisfied with the job under the present circumstances. Teachers (both male and female) working in the professional colleges located in the rural areas were less satisfied with their jobs than those teachers who were working in the professional colleges located in the urban areas.

**D. Sugumar (2011)** carried out a study of job satisfaction among the teaching faculty of self-financing Arts and science Colleges that were affiliated with Bharathidasan University, Tiruchirapalli. The main objectives of the study were: (i) to study the level of Job Satisfaction level among the teaching faculty to the workplace conditions, (ii) to understand the level of job satisfaction of the teaching faculty towards the compensation of the Institution (iii) to understand the job satisfaction level among the teaching faculty towards its institution's infrastructures and (iv) to analyze the job satisfaction level among the teaching faculty towards the professional development of the institutions. The study was conducted on 400 teachers of selected self-financing colleges. The findings revealed that workplace conditions, professional development, and infrastructure significantly created an overall job satisfaction of the teaching faculty, strategic attention needed to be given specifically to the compensation dimension which was closely associated with overall job satisfaction. The formation of a consortium at the state level would be the best choice to exercise the compensation dimension with reasoning.

**Boby Bhuyan (2013)** conducted a study on the job satisfaction of engineering college teachers in Assam. The objectives of the study were: (i) to investigate the job satisfaction of Engineering College teachers based on their age groups and (ii) to examine the differences in job satisfaction between technical and non-technical faculty members of Engineering Colleges. Hypotheses of the study were: (i) there was no significant difference in job satisfaction of Engineering College teachers based on their age groups and (ii) there was no significant difference in job satisfaction between technical and non-technical faculty members of Engineering Colleges. A Descriptive survey method was used. The author used a stratified random sampling method in the study. The researcher selected 248 sample teachers from 4 Government (both under State Government and Central Government) engineering colleges or institutions of Assam namely, Assam Engineering College, Guwahati; Jorhat Engineering College, Jorhat; National Institute of Technology, Silchar and Indian Institute of Technology, Guwahati. The researcher used Teacher's Job Satisfaction Scale (TJSC) prepared by Y. Mudgil (Rohtak), I.S. Muhar (Rohtak), and P. Bhatia (Rohtak), 1991 and the Structural Interview Schedule prepared by the investigator. Table, mean, SD, t-test, and ANOVA were used as statistical techniques for the study. The researcher finally revealed that the mean job satisfaction score of teachers was higher in the high age group followed by the lower age group and last in the middle age group. There was no significant difference between the teachers of technical and non-technical faculty members based on their teaching departments. It was seen from the analysis that both the teachers of technical and non-technical faculties of the four institutions had the same level of job satisfaction. The result showed that the age of the teachers of Engineering Colleges had no significant difference with the perception of their job satisfaction.

**Dr. Kingshuk Adhikari & Mr. Surajit Paul (2017)** carried out a study on the Job Satisfaction of College Teachers: An Empirical Study. The objectives of the study were: (i) to analyze the factor-wise degree of job satisfaction working in Government Degree Colleges of Tripura and (ii) to compare the degree of job satisfaction of Assistant Professors and Associate Professors working in Government Degree Colleges of Tripura. The hypotheses of the study were: (i) there was no significant difference in the satisfaction or dissatisfaction of Assistant Professors and Associate Professors working in Government Degree Colleges of Tripura over the selected organizational factors and (ii) there was no significant difference in overall job satisfaction or dissatisfaction of Assistant Professors and Associate Professors working in Government degree colleges of Tripura. Teachers working in the rank of Assistant Professor and Associate Professor in different government degree colleges of Tripura constitute the population of the study. In the study, the sample consisted of two hundred and twenty (220) teachers posted to different government degree colleges in Tripura. Out of 220 teachers, 163 were Assistant Professors and 57 were Associate Professors working in various Government degree colleges scattered over different districts of Tripura. A structured schedule comprising of a numerical scale ranging from 'Highly Dissatisfied (1)', to 'Highly Satisfied (5)' had been used for the assessment of satisfaction or dissatisfaction of teachers. To analyze the collected data, mean, standard deviation, and independent two samples t-tests had been used.

The result of the study reported that teachers working in government degree colleges of Tripura were satisfied with four factors, namely, 'work itself', 'student matters', 'pay and allowances', and 'promotion matters' while dissatisfaction of teachers had been observed with the factor 'physical facilities for teachers'. However, teachers of both ranks were by and large satisfied with a holistic view. Except for the factor 'of pay and allowances, there was no statistical evidence for the significant difference in the satisfaction of Assistant Professors and Associate Professors working in Government degree colleges of Tripura at a 5% level of significance. The level of job satisfaction of Associate Professor was more as compared to that of the teachers working in the rank of Assistant Professor over the factors 'pay and allowances' and 'promotion matters'. On the contrary, the degree of satisfaction of Assistant Professors was moreover the factors 'work itself and 'student matters' as compared to the level of satisfaction of Associate Professors under consideration. Over the factor 'physical facilities for teachers', both the group of teachers was dissatisfied but the degree of dissatisfaction was marginally higher for Assistant Professors as compared to that of Associate Professors working in government degree colleges of Tripura.

### **III. JUSTIFICATION OF THE STUDY**

As compared to other researchers on job satisfaction of teachers in Manipur, the study of Government college teachers' job satisfaction is very limited. It can undoubtedly operate as a powerful instrument to carry out different responsibilities for social, economic, educational, and political development. There is needed to find out the satisfaction level among government college teachers in Imphal West district in the present time with the increasing number of male teachers greater than the female teachers in population and there are some problems faced during college period about working hours and others. There seems to be a growing discontentment on the part of the teachers towards their job as a result of which standards of education are falling. A varying degree of progress in college education has been made in Manipur and there has been an increasing number of colleges in all parts of the state. It has given access to higher education to several social groups which did not have it in the past. In Manipur, the level of job satisfaction among male and female government college teachers in Manipur is uncertain because the effect on teachers' quality is related to many problems in colleges and universities. There is a long tradition of corruption in selecting college teachers, not for well-qualified academic qualifications and interviews. Female Government teachers are bound to have many personal and family problems regarding satisfaction of job. It is important to know there is a relationship between high educational qualifications and job satisfaction among college teachers. Hence more research is needed on college teachers' job satisfaction.

### **IV. RESEARCH OBJECTIVES**

1. To find out the level of job satisfaction among male and female Government college teachers in Imphal West district.
2. To find out the level of working hours between male and female teachers.
3. To find out the relationship between job satisfaction and educational qualification among male and female teachers.

## V. RESEARCH HYPOTHESES

1. There is no significant difference between the job satisfaction levels of male and female government college teachers in the Imphal West district.
2. There is no significant difference between the working hours of male and female college teachers.
3. There is no significant relationship between job satisfaction and educational qualification among male and female teachers.

## VI. RESEARCH METHODOLOGY

### METHOD

In the study, a descriptive type of method is used. In Descriptive type of research, it includes surveys and fact-finding inquiries of different kinds. It involves the description of an individual, a community, a society, an event, or any other unit under investigation through the use of the questionnaire method, structured interview, schedule, or any other structured method.

### Population and Sample

The population of the study consisted of 335 government college teachers of males and females in the Imphal West district. A sample of 100 college teachers was selected from five government colleges based on a simple random sampling technique. Out of 100 samples, the male and female teachers are in a ratio of 50:50.

### TOOL

In the present study, the Questionnaire of Teachers' Job satisfaction Scale (TJSS-MMB) was developed by Yudhivendra Mudgil, Prof. I. S. Mubar & Prabha Bhatia (2012) was used. The scale has 75 items based on the Likert scaling technique. They are presented on a five-point scale as 5, 4, 3, 2, and 1. Each statement is followed by the five response categories, i.e., Strongly Agree (SA), Agree (A), Indifferent (I), Disagree (DA), and Strongly Disagree (SD).

### PROCEDURE

The researcher took the permission of college principals and heads of departments for administering the Teachers' Job satisfaction scales and fixed dates. On the scheduled date, the researcher meet the college teachers, and the questionnaire was administered personally in five government colleges in the Imphal West district - Imphal College, Manipur College, Oriental College, Mayai Lambi College, and N.G. College. The instructions were explained by the researcher and the doubts were clarified. They were assured that this response will be used for research purposes and will be kept confidential. The scales were collected only after they were responded to by the subject.

### STATISTICAL TECHNIQUES

The raw scores were statistically analyzed in terms of z score norms. Means, standard deviation, and t-tests were used to compare job satisfaction among males and females during their working hours and Pearson product-moment correlation was used to find out the relation between job satisfaction and educational qualification.

## VII. FINDINGS

The findings of the present study are given as follows:

Ho1:- There is no significant difference between job satisfaction levels of government college teachers in the Imphal West district.

**Table 1:** Percentage of Male Government College Teachers According to Job Satisfaction Scores in Imphal West District

Sl.No.	Class Interval	Frequency	Percentage
1	220-240	1	2%
2	240-260	22	44%
3	260-280	23	46%
4	280-300	2	4%
5	300-320	2	4%
Total		50	100%

Source: Primary data

With the help of the above Table 1, it is observed that the job satisfaction scores of male government college teachers started at 220 scores and ended at 320 scores. Among the teachers, 46 percent were between the scores

of 260-280, 44 percent between the scores of 240-260, 4 percent between the scores of 280-300 and 300-320, and 2 percent between the scores of 220-240. So, there is a maximum percentage of male college teachers in the class intervals of 260-280 scores and the least percentage of male college teachers was found between the class intervals of 220-240 scores.

**Table 2:** Job Satisfaction Levels of Male Government College Teachers in Imphal West District

Range of Z-Scores	Numbers of Teachers	Percentage	Grade	Levels of Job Satisfaction
+2.01 and above	2	4%	A	Very High satisfaction
+1.26 to +2.00	0	0%	B	High Satisfaction
+0.51 to + 1.25	12	24%	C	Above Average Satisfaction
-0.50 to + 0.50	19	38%	D	Average
-0.51 to – 1.25	14	28%	E	Below Average Satisfaction
-1.26 to – 2.00	3	6%	F	Dissatisfaction
-2.01 and below	0	0%	G	Highly Dissatisfaction
Total	50	100%		

Source: Primary data

On analyzing the data level of job satisfaction of male government college teachers of Imphal West district, it was concluded that 38% of male college teachers were found at an average level of satisfaction while 28% of college teachers were found below-average satisfaction level, 24% college teachers at above-average satisfaction, 6% at dissatisfaction, 4% at very high satisfaction and not a single college teacher of Imphal West district was found at high satisfaction and highly dissatisfaction level. From the collected data, it is observed that the maximum percentage of male college teachers was found under an average level of job satisfaction and the least percentage of college teachers was found under a very high satisfaction level.

**Table 3:** Percentage of Female Government College Teachers According to Job Satisfaction Scores in Imphal West District

Sl.No.	Class Interval	Frequency	Percentage
1	220-240	1	2%
2	240-260	16	32%
3	260-280	28	56%
4	280-300	5	10%
Total		50	100%

Source: Primary data

From the above Table 3, it is observed that the lowest and the highest job satisfaction scores of female government college teachers in Imphal West district started at 220 scores and ended at 300 scores. Among the teachers, 56 percent were between the scores of 260-280, 32 percent between the scores of 240-260, 10 percent between the scores of 280-300, and 2 percent between the scores of 220-240. It was found that the maximum percentage of female college teachers was found between the class intervals of 260-280 scores and the least percentage of female college teachers was found in the class intervals of 220-240 scores.

**Table 4:** Job Satisfaction Levels of Female Government College Teachers in Imphal West District

Range of Z-Scores	Numbers of Teachers	Percentage	Grade	Levels of Job Satisfaction
+2.01 and above	0	0%	A	Very High satisfaction
+1.26 to +2.00	5	10%	B	High Satisfaction
+0.51 to + 1.25	10	20%	C	Above Average Satisfaction
-0.50 to + 0.50	24	48%	D	Average
-0.51 to – 1.25	5	10%	E	Below Average Satisfaction
-1.26 to – 2.00	5	10%	F	Dissatisfaction
-2.01 and below	1	2%	G	Highly Dissatisfaction
Total	50	100%		

Source: Primary data

On analyzing the data level of job satisfaction of female government college teachers, it can be concluded that 48% of female college teachers were found at an average level of satisfaction while 20% of college teachers were found under above-average satisfaction level, 10% of college teachers at high satisfaction, below-average satisfaction and dissatisfaction level and 2% at highly dissatisfaction level. There is not a single female college teacher in the Imphal West district was found a very high satisfaction level. From the collected data, it has come known that the maximum percentage of female college teachers was found under an average level of job satisfaction and the least percentage of female college teachers was found under highly dissatisfaction level.

From the analysis, there exists a significant difference in different job satisfaction levels of government college teachers in the Imphal West district. The majority of female teachers are more satisfied than the male teachers with an average level of satisfaction in Grade D level. Therefore, hypothesis 1 is rejected.

**Table 5:** T-test to determine working hours of Government college teachers in Imphal West district

Working hours	Gender	N	Mean	SD	t	Sig. (2-tailed)
	Male	50	3.7	1.11	2.23	0.05
	Female	50	2.72	1.08		

Source: Primary data

From Table 5, it is clear that the mean of males and females are 3.7 and 2.72 and their standard deviation is 1.11 and 1.08. Their t-test value is 2.23 which is significant at a 0.05 level of confidence. It means a 95% difference in working hours. There is a significant difference between the working hours of male and female teachers in the Imphal West district.

Most of the male teachers informed that they agreed with the statement 'Teachers should be available to students in the Department/College for about 5 ½ hours daily as recommended by the U.G.C' in the TJSS-MBB questionnaire Sr. No. 55. On the other hand, most of the female teachers disagree with the above statement. Therefore, hypothesis 2 i.e. there is no significant difference in working hours of male and female teachers is rejected.

The degree of correlation is normally ascertained based on its relative measure. This relative measure is known as the coefficient of correlation and is universally denoted by r.

**Table 6** Norms for interpretation and size of the correlation value

Size of Correlation	Interpretation
+1	Positive perfect correlation
+0.6 to +0.99 approx.	Positive correlation of high degree
+0.3 to +0.55 approx.	Positive correlation of moderate degree
+0.1 to +0.25 approx.	Positive correlation of low degree
-1	Negative perfect correlation
-0.6 to -0.99 approx.	Negative correlation of high degree
-0.3 to -0.55 approx.	Negative correlation of moderate degree
-0.1 to -0.25 approx.	Negative correlation of low degree

Source: Research Methodology in Social Sciences, p.329

**Table 7:** Showing Relationship of Job Satisfaction and Educational Qualification of Male Government College Teachers in Imphal West District

Variable	Number of samples	Coefficient of Correlation
Educational qualification	50	0.899
Job satisfaction		

Source: Primary data

Table 7 indicates the simple correlation analysis of educational qualification and job satisfaction of male government college teachers in the Imphal West district. The total number of sample is 50. By using Pearson's Product-moment correlation co-efficient, the computed simple correlation produced an output ( $r=0.899$ ) greater than the critical value of 0.354 at a 0.01 confidence level, PPMC. It reveals that there is a high degree of positive correlation between educational qualification and job satisfaction.

**Table 8:** Showing Relationship of Job Satisfaction and Educational Qualification of Female Government College Teachers in Imphal West District

Variable	Number of samples	Coefficient of Correlation
Educational qualification	50	0.853
Job satisfaction		

Source: Primary data

Table 8 reflects the simple correlation analysis of educational qualification and job satisfaction of female government college teachers in the Imphal West district. The total number of sample is 50. By using Pearson's Product-moment correlation co-efficient, the computed simple correlation produced an output ( $r=0.853$ ) greater than the critical value of 0.354 at a 0.01 confidence level, PPMC. It reveals that there is a high degree of positive correlation between educational qualification and job satisfaction.

Therefore, hypothesis 3 i.e. there is no significant relationship between job satisfaction and educational qualification among male and female teachers is rejected. This can be supported by the statement 'The promotions/appointments in this institution are usually merit-based in Sl. No. 19 in the TJSS-MMB questionnaire. The majority of the government college teachers of Imphal West district revealed that the promotions or appointments in their institution are usually merit-based. In the TJSS-MMB questionnaire Sl. No. 110 - 'The overall working condition in my Department/College are satisfactory' as said by teachers of both male and female government colleges in their job satisfaction scale. But there is more relationship among male than female teachers. It indicates that teachers are satisfied with their job when come to the point that it should be attained by a high educational qualification and well experienced through some years.

## CONCLUSION

The role of college teachers is undoubtedly extremely valuable in the academic life of the students. The overall job satisfaction of college teachers depends on what he or she receives. The behaviors of satisfied teachers will make positive contributions to the institutions. Whereas, dissatisfied teachers become low to contribute their responsibilities in college environment. In Manipur, government college teachers have no equal satisfaction level with their job as the profession of teachers. There are different levels of job satisfaction among government college teachers in the Imphal West district. Among the college teachers, both male and female teachers are satisfied with an average level of job satisfaction in the Grade D level. But in percentage, female teachers are more satisfied than the male teachers. On the other hand, there is a four percent in very high satisfaction level of male teachers in Grade A and ten percent in high satisfaction level of female teachers in Grade B. There is a difference in teachers' working hours during the college period. The majority of the male teachers agreed that they have to work 5 ½ working hours daily as recommended by the UGC. While most of the female teachers disagree with their working hours of 5 ½ hours as prescribed by the UGC. There is a high degree of positive correlation that the appointments and promotions of college teachers are usually selected on a merit-based i.e. high educational qualification and well experienced through some years and there is more relationship among male teachers than female teachers. Therefore, well being of any society depends upon its intellectual assets in general and teaching faculties in particular. The success of higher education depend upon the quality of teachers, to a large extent.

## REFERENCE

- [1] Bretz, R. D. and Thomas, S. L. (1992). Perceived Equity, Motivation, and final offer Arbitration in major league baseball. *Journal of Applied psychology*, pp. 280-287.
- [2] Boby Bhuyan (2013). A study of job satisfaction of engineering college teachers of Assam. *Indian Streams Research Journal*, Volume 3, Issue 3, pp.1-5.
- [3] Chen, S.H. and et. Al., (2006). The development of an employee satisfaction model for higher education. *TQM Magazine*, Vol.1 (5), pp. 484-500.
- [4] College Development Council (2015-16). *College Statistics*. Manipur University, Canchipur-795003, pp. 1-277.
- [5] C. R. Kothari (2004). *Research Methodology Methods and Techniques* (2<sup>nd</sup> Edition). New Age International Publishers, 4835/24, Ansari Road, Daryaganj, New Delhi -110002, p.2.
- [6] Devendra Thakur (2008). *Research Methodology in Social Sciences*. Deep & Deep Publications Pvt. Ltd., F-159, Rajouri Garden, New Delhi -110027, pp.153-174.

- [7] Dr. Chingtham Tomba Singh (2014). Development of Higher Education in Manipur. Akansha Publishing House 4649-B/21, Ansari Road, Darya Ganj, New Delhi – 110002, pp. 25-110.
- [8] Dr. Kingshuk Adhikari & Mr. Surajit Paul (2017). Job Satisfaction of College Teachers: An Empirical Study. EPRA, International Journal of Economic and Business Review, Volume-5, Issue-7, pp. 178-182.
- [9] Dr. Ms. Pabla (2012). A Study of Job Satisfaction among Teachers of Professional Colleges in Punjab. PARIPEX- Indian Journal of Research, Volume1, Issue 10, pp. 111-113.
- [10] D. Sugumar (2011). Study of job satisfaction among the teaching faculty of self-financing Arts and Science Colleges affiliated to Bharathidasan University”, Tiruchirapalli, Ph.D. thesis submitted to Bharathidasan University.
- [11] H.E. Garrett (1971). Statistics in Psychology and Education. Valkils Feffer and Simon, Bombay, pp. 201-231.
- [12] Hoppock, R (1935). Job Satisfaction. Harper and Row, New York.
- [13] Imphal College (2019-20). Confluence Prospectus. pp. 1-28.
- [14] Ishfaq, A., & Talhat, I., (2011). Decoding the Relationship between Employee’s Jobs Related Behaviors: A Study of Telecom Sector of Pakistan. International Journal of Business and Social Science, 2 (8), pp. 244-252.
- [15] Locke, E. A. (1976). The Natural Causes of Job Satisfaction. (In) M.D. Dunnette (ed), Handbook of Industrial and Organisational, Rand McNally, Chicago, pp.1297-1343.
- [16] Manipur College (2021-22). Information Bulletin. pp. 1-17.
- [17] Mayai Lambi College (2021). Prospectus. pp. 1-17.
- [18] N. G. College (2020-21). Prospectus. pp. 1-14.
- [19] Oriental College (2020-21). Prospectus. pp. 1-20.
- [20] Pearson, E. S., and H. O. Hartley (1962). Biometrika Tables for Statisticians.Vol.1, Issue 2, Aufl. Cambridge University Press, Cambridge, p.138.
- [21] Shetty, B. R., and Gujarathi, R., (2012). A Study of Faculty Job satisfaction in Management Institutes of Nashik District Affiliated to the University of Pune. IOSR, Journal of Business and Management, vol. 3, Issue 4, pp. 1-8.
- [22] Trabue, M.R. (1993). Educational Psychology. Prentice-Hall of India Private Limited, New Delhi.
- [23] Wood, O. R., (1976). A research project: Measuring job satisfaction of the community college staff. Community College Review, vol. 3(3), pp. 56-64.
- [24] Yudhivendra Mudgil, Prof. I. S. Mubar & Prabha Bhatia (2012). Teacher’s Job Satisfaction Scale, TJSS-MMB. National Psychological Corporation 4/320, Kacheri Ghat, Agra-282004 (India), pp. 1-7.
- [25] Zahid Javed Bajwa (2017). B.Ed 1 ½ year Educational Statistics Course Code 8614. Department of Early Childhood Education and Elementary Teacher Education, Alama Iqbal Open University, Islamabad, pp. 62-63.
- [26] <https://imphalcollege.edu.in>
- [27] <https://manipurcollege.ac.in>
- [28] <https://mayailambicollege.ac.in>
- [29] <https://ngcollege.ac.in>
- [30] <https://www.orientalcollege.edu.in>
- [31] <https://www.statisticssolutions.com>



## **Role of Hydrogen Ion Concentration (PH) Of Water for the Growth of Cyanobacteria (Blue Green Algae) In Some Sites of Darrang, District Assam, In Pre**

**Matiur Rahman and Milu Rani Das**  
Department of Botany USTM, Meghalaya, India

### **ABSTRACT**

Role of Hydrogen ion concentration of water (pH) for the growth of cyanobacteria is an indicator factor physiological factor. Cyanobacteria is also known as blue green algae. At natural habitat cyanobacteria mostly grows with other algae as mixing behavior, so that it is also known as myxophyceae. The cyanobacterial growth is also influence by other algae as all growth factor acts on cyanobacteria and other surrounding organisms. Different pH factor indicate to grow different cyanobacteria with the support of other physio-chemical and biological factors. Three different sites were taken from the Mangaldoi sub-division, Darrang District, Assam for the period of February, March, April (pre-monsoon) 2019. In this studies it was found that pH in natural fresh water was most important physiological factor among other physiological factors which indicates the growth rate of the cyanobacteria

Keywords: Mangaldoi sub-Division, cyanobacteria , pH in natural fresh water, indicates growth rate of the cyanobacteria

### **INTRODUCTION**

Hydrogen ion concentration (pH) for natural water of cyanobacterial habitat, showed denotation and with mean total cyanobacterial counts (filaments/colony) at some range. The Hydrogen ion concentration (pH) of water for natural blue green algal (cyanobacterial) ecology was influencing cyanobacterial growth. It was interesting that when other phytoplankton grown the cyanobacterial growth was dominated. The variation of seasonal growth and development for cyanobacterial species showed suitable at pre-monsoon season. The other phytoplankton in pre-monsoon season were not grown rapidly, which helped cyanobacteria to consume available nutrient from surroundings. Eutropication process was take place during pre-monsoon from the surroundings due to first rainfall as well as pH was also suitable with other physical and chemical factors for better and abundant growth and development of cyanobacteria. Various factor affecting the distribution of cyanobacteria where hydrogen ion concentration is an influencing factor on their distribution and frequency. Algalization effect under these conditions can be enhanced through proper soil amendments and by selecting pH specific forms (Kausik and Krishnamurti, 1981). Present study attempt to show the naturally occurring cyanobacterial forms in different sites of Darrang District of Assam from different ecosystem of sites, in pre-monsoon season with reference to hydrogen ion concentration (pH) of freshwater in natural habitat of cyanobacteria.

Abiotic factors like hydrogen ion concentration, heat, presence of oxygen, conductivity of electricity are important for cyanobacterial growth. Other chemical factor like density of nitrate or nitrite plays role for blue green algal growth. The role of succession for cyanobacteria is also changing with changing rainfall. Dissolved oxygen in ponds was observed where positive correlation found with cyanobacterial species growth. It was exception in two districts of U.P . The districts are Farukhabad and Mahoba. Conductivity on water of electricity is positively correlated with total number of particles (solid) present . (Suseela et al., 2005).

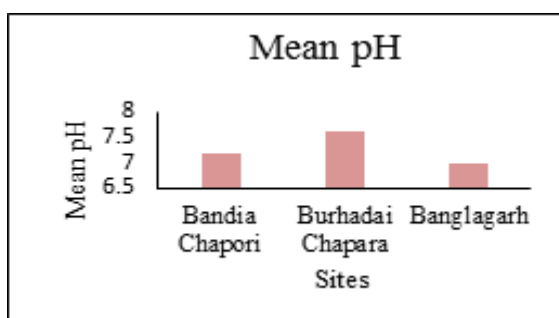
### **MATERIALS AND METHODS**

The hydrogen ion concentration (pH) of the fresh natural water was measured by digital pH meter (Manti Lab Digital pH meter).The natural waters were observed and measured at different times and at different places of sites and taken the records of measurement. The mean of the measurement was recorded and considered for the observation and analysis. Natural growth and development of cyanobacterial effects on different levels of pH, was observed at seven days intervals. Fresh strains or colonies were examined for their growth to different pH levels (6-10) in growth medium of nitrogen free (Fogg,1949). In this present study three different sites were taken for the effect of pH for the growth of cyanobacteria in pre-monsoon season. The sites were Bandia chapori sites, Burhadai chapara sites, Banglagarh sites. 1.0 ml portion of collected samples were ready for shaken and centrifuged by centrifuge machine for separating at high rpm (5000 rpm) for 10 minutes. After the separation of debris the sediment was diluted with 1.0 ml of sterilized water. Than 0.5 ml collected suspension was carefully taken on Sedgewick Rafter Counting Cell slide (76mm x 40mm). (Sedgewick, 1891). Simple cover slip used for covering the slide for observing under compound microscope. Counted cyanobacterial forms as Colony or filament, in numbers  $\text{ml}^{-1}$  was recorded.

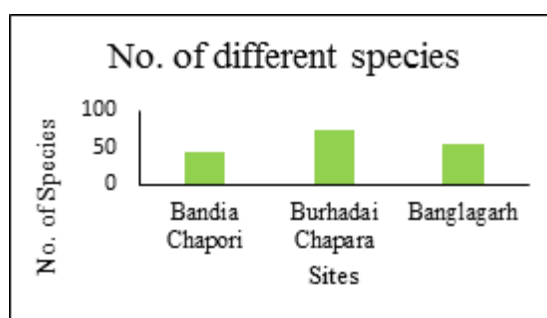
**RESULTS**

**Table 1:** Mean Hydrogen ion concentration (p<sup>H</sup>) of water, Colony or Filament,( numbers ml<sup>-1</sup>), Number of species found in fresh water of pre-monsoon (February, March, April) season of Bandia chapori, Burhadai chapara, Banglagarh of 2019.

Study sites	Hydrogen ion concentration (pH)	Colony or Filament in numbers ml <sup>-1</sup>	Number of different species found
Bandia chapori sites	7.2	2620	44
Burhadai chapara sites	7.6	3960	74
Banglagarh sites	7.0	2640	54



**Fig1.** Mean p<sup>H</sup> of different sites.



**Fig 2.** No. of Species of different sites.

The sites Burhadai chapara site having mean pH 7.6, showing highest number of cyanobacteria was three thousand nine hundred and sixty (3960) colony or filament (in numbers ml<sup>-1</sup>). This sites Burhadai chapara having seventy four (74) numbers of different species found. Bandia chapori site mean pH 7.2, where colony or filament (in numbers ml<sup>-1</sup>) was two thousand six hundred twenty. In this site number of different species found forty four (44). In Banglagarh site mean pH 7.0 where colony or filament (in numbers ml<sup>-1</sup>) were two thousand six hundred forty (2640) having fifty four (54) numbers of different species. Seasonal variation with physical and chemical parameter effect on availability of phytoplankton’s distribution (Ezra and Nwankwo, 2001)

**DISCUSSION**

In this present investigation hydrogen ion concentration (pH) of water 7.6 is more suitable for the growth and development of the cyanobacteria. Cyanobacterial diversity is also rich in Burhadai chapara where 74 number of species was found. The pH ranges from 7.5-10 is the best range for the growth of cyanobacteria (Agarwal and Rajwar,(2010) supports hydrogen ion concentration , conduction of water, hardness of water, deposition calcium, level of DO and BOD were more at summer seasons. Mean pH 7.6, was not only shown dense population but also shown rich cyanobacterial diversity as it was (pre-monsoon) a season where other aquatic diversity was not abundance. Cyanobacteria is the first aquatic life for succession. As Cyanobacteria having mixing habitat behavior it is also influence by biotic factors of food chain, so changing seasonal variation is depend upon changing surrounding vegetation, which vegetation also change by hydrogen ion concentration (pH). The loss of biological diversity of non-calcareous organisms due to species shifts in phytoplankton communities. This may be due to the direct effect of low pH (Kroeker et al. 2010).

**REFERENCES**

1. Agarwal, A. K. and Rajwar, S. (2010). Physico-Chemical and Microbiological Study of Tehri Dam Reservoir Garhwal Himalaya, India. *J. American Sci.*, 6 (6): 65-71.
2. Bhuiya, Z. H. Islam, A. K. M. N. Hashem, M. A., Begum, Z. N. T. and Rahman, M. M. (1984). Effect of blue green algae as biofertilizer on rice. *Bangladesh J. Agr.* 9(2): 47-51.
3. Booth, W.E. (1941). Algae as pioneers in plant succession and their importance in erosion control. *Ecol.*, 22: 38-46.
4. Ezra, A.G. and Nwankwo, D. I. (2001). Composition of phytoplankton algae in Gubi Reservoir, Bauchi, Nigeria. *J. Aquatic Sci.*, 16(2): 115-118.
5. Fishar, M.R. Thorne, R. and Williams, W.P (2006). Physico-chemical conditions and macro invertebrate fauna in the River Nile from Aswan to Cairo. *African J. Aquatic Sci.*, 31(2): 347-259.
6. Fogg, G.E. (1949). Growth and heterocyst production in *Anabaena cylindrical* lemm. II in relation to carbon and nitrogen metabolism. *Ann.Bot.*13:242-249.

7. Kausik, B.D. and Krishnamurti,G.S.R. (1981). Effect of blue green algae and gypsum application on physico-chemical of alkali soils. *Phycus* 20:91-94.
8. Kroeker, K.J Kordas, R.L. Crim, R.N.Sing, G.G (2010). Meta-analysis reveals negative yet variable effects of ocean acidification on marine organisms. *Ecology letters*. volume 13, issue 11. page-1419-1434
9. Nayak, S. and Prasanna, R. (2007). Soil p<sup>H</sup> and its role in cyanobacterial abundance and diversity in rice field soils. *Appl. Ecol. Environ. Res.*, 5 (2): 103-113.
10. Suseela ,M.R.Baghal,V.S.Anit,P Dwividi,C.P.(2005). Freshwater blue green algae from three agro-climatic zones of Uttar Pradesh, India: Distributinal with Seasonal Variation. *J Environ Biol* 2005 vol-26(1)-30.

## Turmeric Powder Samples for Its Quality (*Cucurma Longa*)

Reshma BhanuKumar<sup>1</sup> and Ghadevaru Sarathchandra<sup>2</sup>

<sup>1</sup>Department of Food Process Engineering, MTech Food Safety and Quality Management, SRM Institute of Science and Technology, Kattangulathur, Chengalpattu District, Tamil Nadu, India

<sup>2</sup>Pharmacovigilance Laboratory for Animal Feed and Food Safety, Directorate of Centre for Animal Health Studies, Tamil Nadu Veterinary and Animal Sciences University, Madhavaram Milk Colony, Chennai, Tamil Nadu, India

### ABSTRACT

Turmeric powder (*Curcuma longa* L.) is highly valued for its nutritional properties. Due to its high demand in international trade, turmeric powder has been subject to economically driven, hazardous chemical adulteration. This study aims at assessing the safety parameters of four different brands of food grade turmeric powder brands procured from areas in and around Chennai, Tamil Nadu. Parameters such as physicochemical properties moisture, ash and water activity were studied and all the samples showed more than 8-10% of moisture and around 0.8-0.9 water activity and increased microbial load in all 4 samples for both bacteria and yeast and mould, which according to Food Safety and Standards Authority of India standards for Microbial contamination should have been absent. The other parameter tested was for adulterants like Metanil yellow and chalk powder wherein few samples showed the presence of all these two adulterants. Mycotoxins were also tested using High performance Thin Layer chromatography standard procedures from the literature where, Aflatoxin B1 was 11 microgram per kilogram in one sample and other mycotoxins like ochratoxin, citrinin, etc were absent. Color measurement was done using Hunter colorimeter with Metanil Yellow was the standard. The tests revealed a compromise on safety standards of the samples; hence the Quality assessment of Turmeric powders were analysed and the results were compiled.

Keywords: Turmeric {*Curcuma longa* L} Adulteration, Metanil Yellow, Mycotoxin, Microbial Load, Physicochemical

### INTRODUCTION

Natural plant products have been used for a variety of purposes throughout human history. Many of the plants from which these natural products are derived have co-evolved with animal life and are billions of years old. Nevertheless, modern medicine does not evaluate or encourage the medicinal usage of plant products. *Curcuma longa* has been used a medicinal plant for nearly 4000 years now.

*Curcuma longa* is also known as "Indian saffron" because of its bright yellow color. Modern medicine is beginning to recognize its importance, as evidenced by more than 3000 publications on turmeric that have appeared in the last 25 years.

The rhizome from which turmeric is obtained is bulbous and the skin is coarsely segmented. The rhizome matures in the soil under the leaves. They are tan and dull orange inside. The main rhizome is pointed or tapered at the distal end, 2.5-7.0 cm (1-3 inches) long, 2.5 cm (1 inch) in diameter, and has small tubers branching. Once the *curcuma longa* rhizomes are dry, they can be ground into a bitter, slightly acrid, but sweet-tasting yellow powder.

Turmeric is used to treat rheumatoid arthritis, chronic anterior uveitis, conjunctivitis, skin cancer, small pox, chicken pox, wound healing, urinary tract infections, and liver conditions. It's also used to treat digestive issues including flatulence, jaundice, menstruation problems, and colic, as well as stomach pain and distension (1) and dyspeptic symptoms like loss of appetite, postprandial feelings of fullness, and liver and gallbladder complaints (1).

Turmeric is one such important spice that is prized not just for the beautiful colour and texture it adds to any dish, but also for its medicinal properties. Turmeric powder that is currently available in the market is severely contaminated, robbing it of all of its medicinal properties. Virali Manjal aka Finger turmeric is used to make commercially available Food Grade Turmeric Powder since it is widely available and easy to process. To achieve the pure yellow colour, these food-grade turmeric powders are contaminated with various artificial colours such as Metanil Yellow, Lead chromate, Sudan red, and others. Various methods, including titration approaches, can be used to detect these hues.

Metanil Yellow is among the major constituent when it comes to artificial colours addition into turmeric powder, their presence was confirmed using Fourier Transform InfraRed Spectroscopy, Raman Spectroscopy

(2, 3) and PCR Based Detection (4) was performed. A detailed study on the structure considering the protons and carbons was performed using Nuclear Magnetic Resonance Imaging (5).

Turmeric powder contains a mixture of various compounds including Curcumin being the major constituent along with curcuminoids, alkaloids, phytochemicals and many more. Curcumin is the nutritional compound present in turmeric powder. Various studies have been performed for analysing the activity of curcumin and its structure. Some of the studies include Chemical stability and antiproliferative studies of curcumin (6), Nano emulsified curcumin and commercial curcumin characteristics were compared using various instrumentation facilities (8). Exact validated curcumin estimation was performed using High Performance Thin Layer Chromatography instrument using Methanol as a solvent for extraction. (12).

The purpose behind this research work is to understand that the demand for turmeric powder is not able to meet the needs of the growing population and quantity is preferred over quality. Hence in order to increase this growing need, food items are being adulterated with non-nutritious compounds which deteriorates the health of the consumer in the longer run.

In this study a detailed analysis of commercially available food grade turmeric powder is studied by performing a comparative analysis between four different samples and studying their color adulterants using standardised methods mentioned below.

The scope and implications of the outcome of this survey are far and wide since, Turmeric powder is one of the main ingredients in Indian Cuisine and is widely used across all households in the country. Turmeric has a horde of medicinal properties but the presence of such adulterants which are used to increase the quantity are counterproductive and snub the health benefits from the ingredient. This survey will enable the consumers to make an informed decision while buying ingredients for their food preparation.

## **MATERIALS AND METHODS**

### **SAMPLING:**

Four Commercially available Food Grade Turmeric powder samples were procured from the commercial market in and around Chennai and named as A, B, C and D. Other than microbial in air-tight containers. All the below mentioned tests were done in triplicates.

### **Physicochemical parameter testing**

#### **MOISTURE:**

Moisture content in all these samples were tested using the standard proximate testing procedure where samples were weighed accurately and added in 4 different dishes and at different time intervals the weight was noted along with initial weight and final weight. Experiment was done in triplicates and values were noted.

#### **WATER ACTIVITY:**

Water activity was noted in a water activity meter. Experiment was done in triplicates and values were noted.

#### **ASH:**

This was performed using crucibles where, the crucible weight along with the sample was noted as the initial weight and after the sample was ashed at 560 degrees in the muffle furnace again weight was noted and calculated using the standard formula.

### **Microbiological Contamination Study:**

Total plate count and yeast and Mould count was measured to determine the contamination level in various turmeric powder samples. The procedure was followed as per AOAC standard protocol.

Samples were isolated from the commercially available turmeric powder packets and aseptically prepared in sterile air tight containers for microbial load detection. No. of samples considered were 4 main samples (Different brands from market was taken). Along with control 4 sub samples from each of these samples were taken to facilitate statistical data interpretation. Medium was prepared after serial dilution of the sample and further process was continued by using Plate count Agar for bacterial count and potato dextrose agar for yeast and mould.

## **ADULTERANTS DETECTION**

### **Detection of Metanil Yellow and Lead Salts:**

1 gram of sample was mixed with 5 ml of hydrochloric acid and appearance of pink color indicates the presence of Lead salts and when dissolved in water leading to disappearance of pink color indicates presence of Metanil yellow.

#### **DETECTION OF CHALK POWDER:**

1gram of sample was mixed with few ml of water to observe an effervescence which shows the presence of chalk powder.

#### **COLOR MEASUREMENT:**

Color was measured for all 4 samples using hunter colorimeter and wavelength was determined. The Graph obtained for each sample was compared with graph obtained for Metanil Yellow as the standard.

#### **Estimation of Mycotoxin using high performance thin layer chromatography**

##### **Methodology for Aflatoxin Extraction:**

25 grams of the samples were measured in a beaker, mixed with 106 ml acetone, 19 ml of distilled water and 1 scoop of sodium chloride. Extraction bottle was then placed on the rotator shaker for a period of 30 mins at 200 rpm for extraction and homogenization. The mixture was then filtered through ordinary filter paper to run for the liquid-liquid phase clean up procedure. 75 ml was collected in the fresh beaker along with 0.3 gm cupric carbonate powder added to remove the interference caused by chlorophyll in the analysis. The mixture was then filtered through ordinary filter paper to run for the liquid-liquid phase clean up procedure. 75 ml was collected in the fresh beaker along with 0.3 gm cupric carbonate powder added to remove the interference caused by chlorophyll in the analysis. The mixture was then allowed to settle for 10 mins before filtering through Whatman paper (No.1) and 100 ml was collected. 100 ml filtrate was transferred into a 500 ml separating funnel and added 100 ml of 0.03 % sulphuric acid and 25 ml of chloroform. The mixture was shaken vigorously releasing the fumes or gases and allowed to settled for 10 minutes (Toxins are brought into acidic phase by partition. Chloroform extracts and binds to aflatoxin). The contents get divided into 2 distinct layers with the lower layer containing chloroform bound to aflatoxin. The lower layer was collected into a 100 ml separating funnel and mixed slowly with 40 ml of 1 % potassium chloride and 0.02M potassium hydroxide solution by gentle shaking and allowing for separation. The lower layer containing aflatoxin bound to chloroform was then filtered through a bed of 10 gm anhydrous sodium sulphate and collected in a beaker. The content of the beaker was then evaporated by placing them on the hot plate with a constant temperature of 120° C. The content was transferred to amber colored vials before complete drying. The extract was evaporated in a hot plate under the fume hood. Finally, the dried extract was re-dissolved in 0.2 ml of chloroform and used for Thin layer and high performance thin layer chromatography.

#### **ESTIMATION OF MULTITOXIN:**

With 25g of sample, add 88ml acetonitrile, 2ml 20% sulphuric acid, 4% potassium chloride and 1 scoop of sodium chloride and keep in stirrer for 3 mins and in shaker for 30 mins. Add 250ml of the mixture into a separating funnel after filtering through filter paper. Then add 50ml filtered sample and 50ml distilled water along with 50ml hexane and shake. Collect the lower part into a measuring cylinder and discard the upper layer. In another 250ml separating funnel, add 50ml of the collected lower sample along with 50ml of hexane and Shake. Now collect the lower part into a measuring cylinder and finally wash the separating funnel. In one other 250ml separating funnel, add 50ml of that collected lower sample along-with 20ml chloroform and shake and allow it to separate. Gently tilt the separating funnel and collect lower layer over anhydrous sodium bisulphate bed and then evaporate to near dryness.

#### **RESULTS**

**Table 1:** Physicochemical Parameter values

The procedures for physicochemical parameter testing were followed as per the protocol mentioned in the food safety standards authority of India Lab Manual 10. The higher the water activity the faster the microorganisms like bacteria, yeast and mold will be able to grow. Since turmeric powder is an organic compound, it has natural and artificial contaminants including some inorganic compounds.

<b>Samples</b>	<b>Moisture (%)</b>	<b>Water activity</b>	<b>Ash (%)</b>
<b>A</b>	0.34	0.428	10
<b>B</b>	0.9	0.509	8.4
<b>C</b>	0.95	0.528	12
<b>D</b>	0.64	0.479	11

**Table 2:** Microbial Contamination Estimation

Turmeric powder is isolated from curcumin rhizome which is found under soil level and it is prone to a lot of bacterial load which is the reason for contamination. This table clearly elucidates the values of total plate count

colonies which falls in between the values of  $1.5 \times 10^4$  to  $2.6 \times 10^4$  (cfu/g) and the Yeast and Mould colonies were found within the ranges of  $1.7 \times 10^4$  to  $2.2 \times 10^4$  (cfu/g)

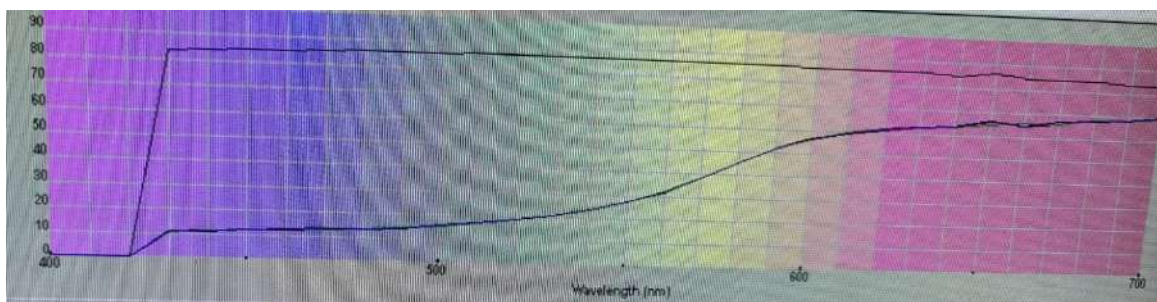
Samples	Total plate count colonies (cfu/g)	Yeast and Mould colonies (cfu/g)
A	$2.6 \times 10^4$	$1.8 \times 10^4$
B	$2.9 \times 10^4$	TNTC
C	$1.5 \times 10^4$	$1.7 \times 10^4$
D	$1.8 \times 10^4$	$2.2 \times 10^4$

**Table 3:** Color Analysis using Hunter Colorimeter

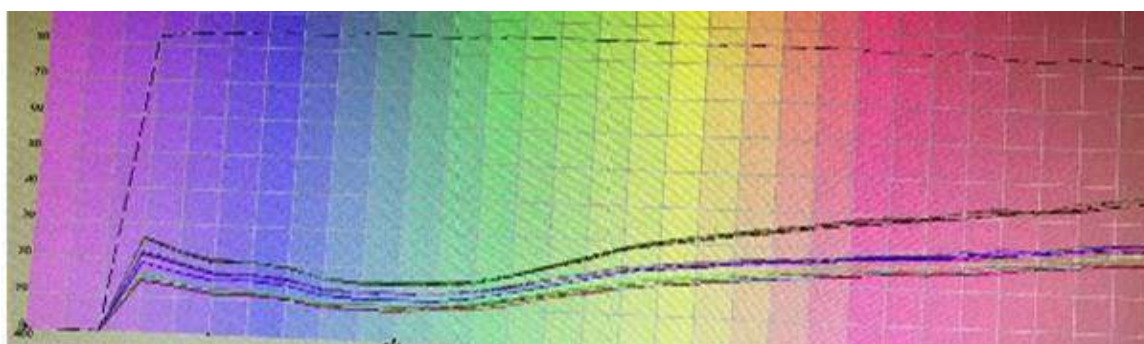
Color analysis was done using Hunter colorimeter and the mean values of three readings of each color was noted at a wavelength of 580 nanometres. L represents lightness of the product, +a\* represents redness, -a\* represents green, +b\* represents yellowness, -b\* represents blue and finally dE is the total color difference. Mean values of 3 readings of each color was noted at wavelength of 580nm.

Samples	L	a*	b*	dE*
A1	47.71	13.09	13.49	49.64
A2	46.69	12.93	13.76	50.57
A3	51.06	12.75	13.73	49.71
B1	48.26	14.02	12.38	46.77
B2	46.27	14.50	13.91	49.69
B3	47.72	14.27	14.16	51.47
C1	52.74	12.49	10.77	44.99
C2	52.22	12.33	10.41	44.42
C3	51.94	12.21	9.80	45.10
D1	58.15	15.89	13.36	41.36
D2	57.88	15.98	13.28	41.63
D3	57.48	15.76	13.12	41.86

**Table 4:** Mycotoxin Detection using High Performance Thin Layer Chromatography



**Figure 1:** Color analysis performed by Hunter Colorimeter indicating wavelength and absorbance of turmeric powder samples. X axis indicates wavelength in nanometres and Y axis indicates mean values for three readings of the samples.



**Figure 2:** Standard Metanil Yellow graph with the above-mentioned axis metrics

Toxins such as Aflatoxin B1, Aflatoxin B2, Aflatoxin G1 and Aflatoxin G2 were tested along with Citrinin, Ochratoxin A and T2 Toxin were tested using High Performance Thin Layer chromatography. Mobile phase = chloroform: Acetone::1:9. This analysis was done under fluorescence mode using Mercury detector at the wavelength of 366 nm

S.No	TEST	SAMPLE A	SAMPLE B	SAMPLE C	SAMPLE D	UNIT	LOD (µg/kg)
1	AflatoxinB1	11	BDL	BDL	BDL	µg/kg	5
2	AflatoxinB2	BDL	BDL	BDL	BDL	µg/kg	2
3	AflatoxinG1	BDL	BDL	BDL	BDL	µg/kg	5
4	AflatoxinG2	BDL	BDL	BDL	BDL	µg/kg	5
5	Citrinin	BDL	BDL	BDL	BDL	µg/kg	20
6	Ochratoxin A	BDL	BDL	BDL	BDL	µg/kg	20
7	T2 Toxin	BDL	BDL	BDL	BDL	µg/kg	60

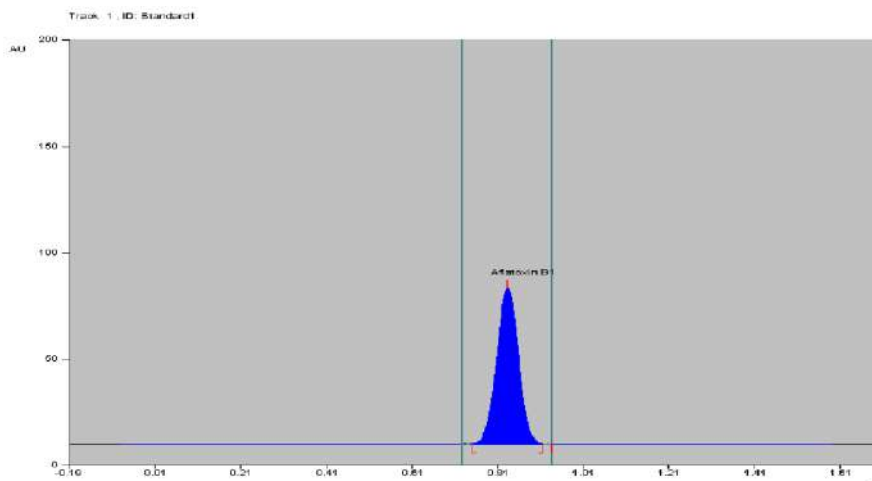


Figure 3: Aflatoxin Standard Peak in High Performance Thin Layer Chromatography

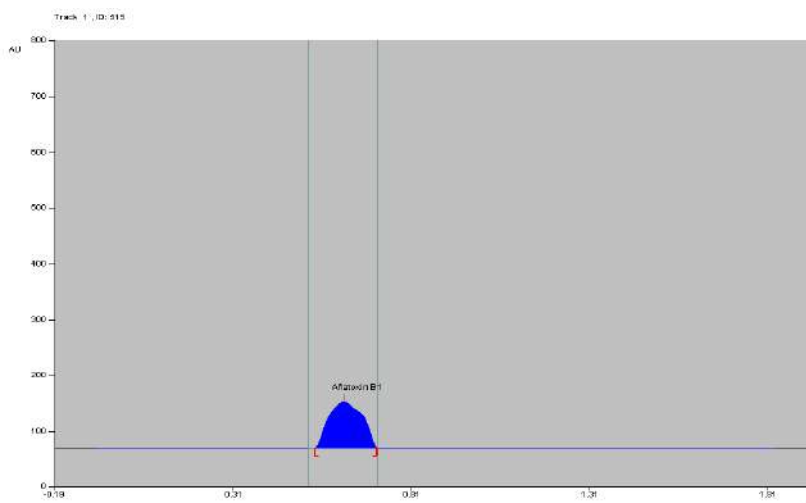


Figure 4: Positive sample peak indicating Presence of Aflatoxin B1 in High Performance Thin Layer Chromatography. Area of Coloured region is calculated to determine the amount of Aflatoxin present in Sample A.

**Adulteration Detection**

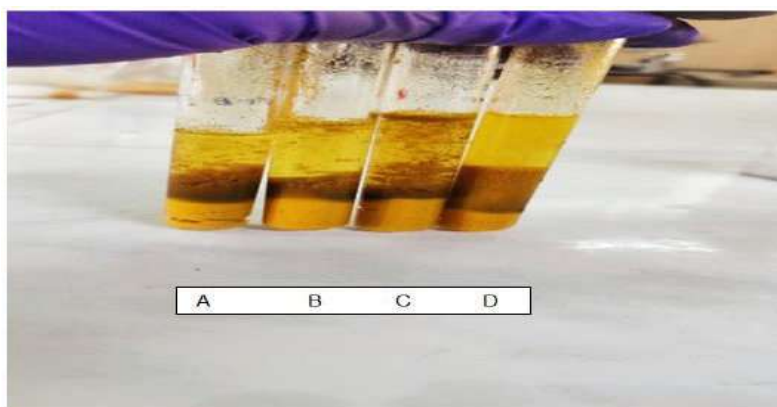


Figure 5: Detection of Metanil Yellow. Appearance of Red Color was observed.





**Figure 6:** Presence of Lead Salts. Disappearance of Red color on addition of water was observed.



**Figure 7:** Presence of Chalk Powder. Effervescence was observed.

## DISCUSSIONS

The Food Safety and Standard Authority of India has set a permissible level of not more than 9% on dry weight basis for moisture level in Turmeric powder as per the results it was confirmed that the moisture and water activity of all the four samples were within the prescribed limits. The permissible level of ash content in turmeric powder sample is only 9% as per Food Safety and Standard Authority of India, the values ranged from 8.4-12% in all the four samples where 75% of them were far more than the permissible range and the rest 25% of the sample fell within this range. The results for bacterial contamination ranged from  $1.5-2.9 \times 10^4$  cfu/g and for yeast mold was Too Numerous To Count (TNTC), this condition might be due to the increased amount of moisture and water activity which reduces the shelf life of the product thereby permitting ways for insects and /or rodents to enter. The presence of Metanil yellow, Lead Salts and Chalk powder was confirmed through qualitative tests. The peak for all 4 samples were observed at 580nm and that is similar to peak obtained by Metanil yellow at 473 nanometres where the frequency was at 5.16 Hertz and the energy was 2.14 electron volts, since the color range is similar to the peaks as in Metanil Yellow standard graph we confirm that the samples were administered or adulterated with Metanil yellow for the yellow color of the turmeric powder to be enhanced. Sample A showed the presence of Aflatoxin B1 up to  $11\mu\text{g}/\text{kg}$  as per Food Safety and Standard Authority of India, the permissible Toxin limit is  $0.5\mu\text{g}/\text{kg}$  and the results were more than the permissible amount. Mycotoxin levels beyond permissible level causes detrimental health effects (13, 14).

## CONCLUSION

Commercially available food grade turmeric powder was tested for its safety and quality and the following data was observed. It was found that the samples taken for testing were contaminated in one way or the other. Addition of Metanil yellow adulterant is harmful to health since it is carcinogenic in nature. This survey is a brief study which gives an outline about the presence of toxins, microbes and adulterants in commercial food grade turmeric powders. This survey is to enable the consumers to make an informed decision regarding their nutrition and establish transparency between the product and the consumers.

## ACKNOWLEDGEMENTS

I thank the almighty for making me stay motivated and focussed throughout this working period.

I'm grateful to SRM Institute of Science and Technology for providing with all equipment and instrumentation for carrying out the project work successfully.

I would like to thank the head of my department Dr. Mr. P. Gurumoorthi, for his constant support during the tenure of my project.

I thank my Project Advisor Dr. Ghadevaru SarathChandra for his continued support and encouragement in imparting knowledge which aided me in this research. He continually and convincingly conveyed a spirit of adventure in regard to research. Without his guidance and persistent help this particular research work would not have been possible.

I convey my deepest gratitude to my parents for their constant support and encouragement they provided during my working period.

Special thanks to laboratory assistants and friends for helping me during the lab work.

## REFERENCES

- 1) Bundy, Rafe.; Ann. F.; Richard W.; Turmeric Extract may Improve Irritable Bowel Syndrome Symptomology in otherwise healthy adults. *Journal of Alternative and Complementary medicine*. 2005, Vol. 10, No. 6.
- 2) Sagar Dhakal, Kuanglin Chao.; Walter Schmidt.; Jianwei Qin.; Moon Kim.; Diane Chan.; Evaluation of Turmeric Powder Adulterated with Metanil Yellow Using FT-Raman and FT-IR Spectroscopy. MDPI. 2016
- 3) Saumita. Karl.; Bipan. Tudu.; Anil K.; Bag.; Rajib. Bandyopadhyay.; Application of Near-Infrared Spectroscopy for the Detection of Metanil Yellow in Turmeric Powder. *Journal of Food Analytical methods*. 2006, Vol 12, No. 9
- 4) Sasikumar. B.; Syamkumar. S.; Remya. R.; John. T.; PCR Based Detection of Adulteration in the Market Samples of Turmeric Powder. *Journal of Food Biotechnology*. 2004, Volume 18.
- 5) Florastina Payton., Peter Sandusky., William L. Alworth.; NMR Study of the Solution Structure of Curcumin. *Journal of Natural Products*. 2007, Volume 70, No. 2
- 6) Yuting Fan., Jiang Yi., Yuzhu Zhang., Wallace Yokoyama.; Improved chemical stability and antiproliferative activities of curcumin loaded nanoparticles with chitosan-chlorogenic acid conjugate. *Journal of Agricultural and Food chemistry*. 2017.
- 7) Haixia Yang., Zheyuan Du, Weicang. Wang, Mingyue Song., Katherine Z. Sanidad., Elvira Sukamtoh., Jennifer Zheng., Li Tian., Hang Xiao., Zhenhua Liu., Guodong Zhang.; Structure and Activity Relationship of Curcumin: Role of Methoxy Group in Anti-inflammatory and Anti-colitis Effects of Curcumin. *Journal of Agricultural and Food chemistry*. 2017.
- 8) Bingjing Zheng., Shengfeng Pen., Xiaoyun Zhang., David Julian McClements.; Impact of delivery system type on curcumin bioaccessibility: Comparison of curcumin-loaded nano emulsions with commercial curcumin supplements. *Journal of Agricultural and Food Chemistry* 2018.
- 9) Pierre Dagot., Verena Huber., Didier Tourand., Werner Kunz.; Curcumin extracts from *Curcuma Longa* – Improvement of concentration, purity, and stability in food-approved and water-soluble surfactant-free microemulsions. *Journal of Food Chemistry*. 2021, Volume 339.
- 10) Shuichi Shimma., Takehito Sagawa.; Microscopy and Mass Spectrometry Imaging Reveals the Distributions of Curcumin Species in Dried Turmeric Root. *Journal of Agricultural and Food Chemistry*. 2019.
- 11) McKee. L. H.; Microbial Contamination of Spices and Herbs: A Review. *Journal of Microbiology*, No. 1, 1995.
- 12) Gantait.; Arunava Barman.; Topu Mukherjee.; Pulok K.; Validated method for estimation of curcumin in turmeric powder. *NIScPR Online Periodicals Repository*. 2011, pp 247-250
- 13) Bultern Kabak., D.W.Dobson Alan.; Mycotoxin in spices and herbs An update. *Journal of Food Science and Nutrition*. 2017, Volume 57.
- 14) Zdenka Veprikova., Milena Zachariasova., Zbynek Dzuman., Alena Zachariasova.; Mycotoxins in Plant-Based Dietary Supplements: Hidden Health Risk for Consumers. *Journal of Agricultural and Food Chemistry*. 2015.

- 15) Majid. Golami.; Nader. Rangsaz.; Shahrzad. Azizi.; Evaluation of turmeric (*Curcuma longa*) effect on biochemical and pathological parameters of liver and kidney in chicken aflatoxicosis. *Journal of Pharmaceutical Biology*. 2015, pp 780-787
- 16) Official Methods of Analysis of AOAC International. 2016. 19th Edition. Edited by Patricia Cuniff. Published by AOAC International. Virginia. USA. Test 17.2 .01
- 17) Food Safety and Standards Authority of India., *Manual of Methods of Analysis of Foods., Spices and condiments., Lab Manual 10.*
- 18) Pierre Dagot., Verena Huber., Didier Tourand., Werner Kunz.; Curcumin extracts from *Curcuma Longa* – Improvement of concentration, purity, and stability in food-approved and water-soluble surfactant-free microemulsions. *Journal of Food Chemistry*. 2021, Volume 339.
- 19) Shuichi Shimma., Takehito Sagawa.; Microscopy and Mass Spectrometry Imaging Reveals the Distributions of Curcumin Species in Dried Turmeric Root. *Journal of Agricultural and Food Chemistry*. 2019.
- 20) Sagar chakkal., Kuanglin Chao., Walter Schimdt., Moon Kim.; Evaluation of Turmeric Powder Adulterated with Metanil Yellow Using FT-Raman and FT-IR Spectroscopy. *Journal of Foods*. MDPI. 2016.
- 21) Parvathy V. A., Swetha V. P., Shreeja T.E.; Detection of plant based adulterants in turmeric powder using DNA Barcoding. *Journal of Pharmaceutical Biology*. 2015

## An Analysis of the Effective Viscosity of Nanofluids

Shefali Gupta, Ritu Pasrija\* and Saurabh Narang  
DAV College Abohar, India

### ABSTRACT

Nanofluids have grabbed a substantial amount of attention in the recent past for its extraordinary heat transfer properties than conventional fluids. Like other thermo-physical properties such as thermal conductivity, specific heat and diffusivity, viscosity plays a significant role in determination of the fluid flow and in heat transfer mechanism. Therefore numerous researches have been done on the rheological behavior of the nanofluids. Nanofluids exhibit higher viscosity than conventional fluids. The existing classical models underestimate the viscosity of nanofluids. Among the various factors influencing the viscosity of nanofluids, the present work studies the effect of interfacial layer and aggregation of nanoparticles on the viscosity of nanofluids. The results of present model are in good agreement with available experimental data and give better predictions for the effective viscosity of nanofluids compared to existing classical models.

Keywords: Nanofluids, Viscosity, Agglomeration

### INTRODUCTION

To meet the ever increasing demand for more efficient heat transfer systems in industrial applications such as transportation, electronics, nuclear reactors as well as biomedicine and food, Nanofluids have evoked immense interest among the researchers in recent years. Nanofluids are the suspensions of nanosized particles in the base fluids like water, ethylene glycol, engine oil, glycerol etc. Owing to large specific area and small size of nanoparticles, Nanofluids exhibit superior properties than the conventional fluids. A number of studies have been done to evaluate the transport properties of nanofluids. Most of the studies focused on the thermal conductivity of the nanofluids. Besides thermal conductivity, viscosity is an important property which relates directly to fluid resistance, pumping power and convective heat transfer.

At the beginning of the twentieth century, Einstein [1], Brinkman [2], Batchelor [3], and Lundgren [4] proposed analytical models based on the well-established theory of colloidal suspensions to estimate the viscosity of nanofluids. But these classical models predicted the lower value of effective viscosity of nanofluids when compared to the experimental results which clearly show the enhancement in the viscosity of nanofluids with the increase in particle concentration. Murshed et.al 2008 [5] reported an increment of 86% and 82% in relative viscosity of water based TiO<sub>2</sub> and Al<sub>2</sub>O<sub>3</sub> nanofluids respectively. An increase of 60% in the relative viscosity of base fluid has been observed by Duan et al [6] with just 5% increase in the volume fraction of alumina nanoparticles in water. Garg et.al [7] discovered that there is four times increase in viscosity of Cu/EG (ethylene glycol) nanofluids when compared with the Einstein model. Chevalier et.al [8] experimentally found that viscosity of SiO<sub>2</sub>-Ethanol nanofluid for different particle radius (17, 47, 95 nm) rises abnormally with the increase in volume concentrations. Experimental viscosity values were found to advance with the volume fraction as shown by Lu and Fan [9]. Phuoc and Massoudi [10] discovered experimentally viscosity of Fe<sub>2</sub>O<sub>3</sub>/deionized water based nanofluids rises with increasing particle volume concentration. Duang Thongsuk et. al [11] experimentally investigated the viscosity of TiO<sub>2</sub> nanoparticles suspended in water with volume fraction ranging from 0.2 to 2 vol% and temperature between 15 °C and 35 °C. They reported that the viscosity of nanofluids increases as particle concentration increases and is quite different from that of the predicted values. The deviation in the experimental findings from that of the theoretically predicted values could be due to dependence of viscosity on some other parameters such as temperature, particle size, shape, base fluid type, pH value, shear rate, stabilizing surfactants, particle agglomeration and the interfacial layer.

The current work aims at the study of the effective viscosity of nanofluids taking into consideration the effect of interfacial layer, particle size and shape and aggregation of nanoparticles. Furthermore, it also highlights some of the existing theoretical models and experimental correlations proposed to explain the anomalous behaviour of the viscosity of nanofluids.

### Existing theoretical/empirical models for the viscosity of nanofluids

A number of research works have been carried out on viscosity property of nanofluids but only a few studies have focused on developing the theoretical models for predicting the effective viscosity of nanofluids. There is no widely accepted model that could estimate the viscosity of nanofluids accurately. Thus researchers primarily

use classical models or empirical models proposed on the basis of available experimental data to explain the rheological behavior of nanofluids.

The most popular model for the estimating the viscosity of nanofluids is Einstein's model (1906) that considered linear viscous fluid with dispersion of rigid spherical nanoparticles at very low concentration not more than 2 vol% [1]. The effective viscosity of suspension is given by

$$\mu_{eff} = \mu_f (1 + 2.5\phi)$$

where  $\mu_f$  is base fluid viscosity and  $\phi$  is the volume fraction of dispersed particles.

Brinkman [2] modified the above model and extended it for the viscosity of dispersed fluid upto 4% volume fraction given by

$$\mu_{eff} = \mu_f (1 - \phi)^{-2.5}$$

Considering the interactions between the suspended particles and brownian motion, Batchelor [3] developed correlation for predicting the viscosity of nanofluids as

$$\mu_{eff} = \mu_f (1 + 2.5\phi + 6.2\phi^2)$$

Guo et al. [12] upgraded Batchelor's model taking effect of particle size and then presented new correlation as follows:

$$\mu_{eff} = \mu_f (1 + 2.5\phi + 6.5\phi^2)(1 + 350\phi/d)$$

where  $d$  is the particle radius.

A similar correlation to Einstein model has been developed by Graham [13] based on the Brownian motion, vander waal and electroviscous interaction. Including the effect of particle size ( $d_p$ ) and interparticle distance ( $d$ ), the correlation is expressed as

$$\mu_{eff} = \mu_f \left( 1 + 2.50\phi + \frac{4.5}{\left(\frac{d}{d_p}\right)\left(2 + \frac{d}{d_p}\right)\left(1 + \frac{d}{d_p}\right)^2} \right)$$

Frankal and Acrivos [14] suggested a model for Newtonian viscosity of suspensions containing spherical particles as

$$\mu_{eff} = \mu_f \frac{9}{8} \left( \frac{(\phi/\phi_m)^{1/3}}{1 - (\phi/\phi_m)^{1/3}} \right)$$

where  $\phi_m$  is the maximum volume fraction determined experimentally. The power law model for the determination of viscosity of nanofluids at higher volume fraction more than 2% was developed by Nielsen [15]. The model is presented as

$$\mu_{eff} = \mu_f (1 + 1.5\phi)e^{\phi/(1-\phi_m)}$$

Masoumi et al. [16] included the effect of Brownian motion, density of nanoparticles, temperature and diameter of nanoparticles on effective viscosity and developed the model accordingly as

$$\mu_{eff} = \mu_f \left( 1 + \frac{\rho_n V_b d_n^2}{72C\mu_f} \right)$$

where  $\rho_n$  denotes the density,  $d_n$  represents the particle diameter,  $\delta$  is the distance between the nanoparticles and  $C$  and  $V_b$  are the two temperature dependent functions. Krieger and Dougherty [17] put forward a semi empirical model for different volume fractions assuming the difference in viscosity at different shear rates. The expression of effective viscosity is as follows

$$\mu_{eff} = \left(1 - \frac{\phi}{\phi_m}\right)^{-\eta\phi_m}$$

where  $\phi_m$ , the maximum volume fraction of nanoparticle is found to vary between 0.495 and 0.54 for static fluid and is equal to 0.605 for high shear rates.  $[\eta]$ , the intrinsic viscosity has a typical value of 2.5 for mono disperse suspensions of hard spherical particles.

Chen et al. [18] modified the above equation and considered the effect of maximum packing fraction within the aggregate structure. The modified form of correlation is

$$\frac{\mu_{eff}}{\mu_f} = \left(1 - \frac{\phi_a}{\phi_m}\right)^{-2.5\phi_m} \quad \text{where } \phi_a = \phi \left(\frac{a_a}{a}\right)^{3-D}$$

where  $a$  and  $a_a$  are the size of primary particles and the aggregates, respectively and  $D$  is the fractal index having value of 1.8 for nanofluids.  $\phi_m$  is the maximum particle volume fraction which can be determined experimentally. Garg et al. [7] proposed an empirical model by fitting linearly their Newtonian Cu/EG nanofluids viscosity data, which takes the following form

$$\mu_{eff} = \mu_f (1 + 11\phi)$$

Namburu et.al [19] experimentally investigated the rheological behavior of an aqueous solution of ethylene glycol containing CuO<sub>2</sub> nanoparticles at volume fraction ranging from 0 and 6.12% and temperatures between 35°C to 50°C. Based on the experimental data, a correlation was developed that gives the temperature and volume fraction dependence on viscosity as

$$\log(\mu_{eff}) = Ae^{-BT}$$

$A$  and  $B$  are constants and were calculated with the correlations below

$$A = 1.8375\phi^2 - 29.643\phi + 165.56$$

$$B = 4 \times 10^{-6} - 1 \times 10^{-3} + 1.86 \times 10^{-2}$$

Jamshidi et.al [20] experimentally studied the effect on the viscosity of base fluids like water, ethylene glycol and transformer oil by adding SiO<sub>2</sub> nanoparticles at different concentrations. The presented data shows the enhancement in the effective viscosity with volume fraction whereas it decreases when the temperature increases. They presented a new correlation as a function of volume fraction and temperature to predict the effective viscosity

$$\mu_{eff} = \exp(aT + b)$$

with  $a = -0.03959 - 0.01523\phi$  and  $b = 3.53267 + 6.3848\phi$ . In the above correlation,  $T$  (°C) is the fluid temperature. Minakov et al [21] studied experimentally the rheological behaviour of water, ethylene glycol and engine oil based nanofluids containing different oxides particles and diamond. They showed that nanofluids demonstrate non Newtonian behavior at higher particle concentration and is well described by Herschel-Bulkley fluids model.

Heyhat et al. [22] presented an exponential correlation of the viscosity of alumina-water nanofluid and volume fraction (ranging from 0.1 to 2%). The effect of volume fraction on viscosity of nanofluid over the temperature range of 20-60 °C was studied and is given by

$$\mu_{eff} = \mu_f \exp\left(\frac{5.989\phi}{0.278 - \phi}\right)$$

Sharifpur (2015) et al. [23] measured viscosity of Al<sub>2</sub>O<sub>3</sub>-glycerol based nanofluids with different sized Al<sub>2</sub>O<sub>3</sub> nanoparticles. Fitting the experimental results, they proposed the effective viscosity as function of particle concentration, size and temperature using the dimensional analysis

as

$$\mu_{eff} = \mu_f \left(1 + R(\mu) \left(\frac{T}{T_0}\right)^a \phi^\beta \left(\frac{d}{h}\right)^\gamma\right)$$

where R is the system dependent parameter,  $\mu$  the intrinsic viscosity, d denotes the nanoparticle diameter, h gives the thickness of the interfacial layer, and  $\alpha$ ,  $\beta$ , and  $\gamma$  are fitting parameters. The values of R and  $\alpha$ ,  $\beta$ ,  $\gamma$  were fitted to be 240.19, 0.807, 2.480 and  $-0.522$ , respectively.

The correlation suggested by Chiam et.al (2017) al. [24] for dynamic viscosity of water/EG mixtures with  $\text{Al}_2\text{O}_3$  nanoparticles for different base ratio of 40:60, 50:50 and 60:40 is

$$\mu_{eff} = \mu_f \left[ \left( 1 + \frac{\phi_v}{100} \right)^{32} \left( \frac{T}{70} \right)^{-0.001} (0.1 + BR)^{0.08} \right]$$

Akbari et.al [25] examined the dependence of relative viscosity of  $\text{SiO}_2$ /ethylene glycol (EG) nanofluid on concentration and temperature. The viscosity of different nanofluid systems at volume concentrations varying from 0.1% to 3% was measured. The experimental data indicated a Newtonian behavior of nanofluid at all temperatures range chosen. The dynamic viscosity increases with the increase in nanoparticles volume fraction. A new correlation suggested in this work is

$$\mu_{eff} = \mu_f (-24.81 + 3.23T^{0.08014} \exp(1.838\phi^{0.002334}) - 0.0006779T^2 + 0.024\phi^3)$$

Maher Dhahri et. al in 2019 [26] also contributed an empirical correlation for viscosity of nanofluid based on the available experimental data of different nanofluids such iron, alumina, silica suspended in water, kerosene and propylene glycol. The correlation given by them relates nanofluid viscosity with viscosity of base fluid, particle volume fraction, size and temperature of nanoparticle and mass density of base fluid as

$$\frac{\mu_{eff}}{\mu_f} = \left[ \frac{1 + \frac{\phi}{1 + 2.5\phi}}{1 + \phi \frac{\mu_f}{1 + 2.5\mu_f}} \right]^m \left[ \frac{d_p}{\left( \frac{6M}{N\pi\rho_f} \right)^{1/3}} \right]^h e^{\left( \frac{(1+T^{1.7})^d}{1+T^4} \right)^d}$$

where d, m and h are the parameters found by fitting to the experimental data.

Besides the dependence of nanofluid viscosity on particle volume fraction and temperature there are other parameters that influences the viscosity of the nanofluid such as type of base fluid, particle shape, clustering of nanoparticle, thickness of interfacial layer, aspect ratio, shear rate. Among them, role of interfacial layer around the nanoparticle and agglomeration of nanoparticles is much influential as it not only alters the effective volume fraction but also affects the shape and size of nanoparticle thereby changes the viscosity of nanofluids. Various researchers attempted to speculate the viscosity of nanofluids based on these parameters. Timofeva et. al [27] presented effective viscosity correlation of nanofluids depending on the shape of alumina nanoparticles in alumina EG/water nanofluid. Jefferey in 1922 [28] further carried the work of Einstein for suspensions containing the ellipsoidal particles and provided the maximum and minimum limits of intrinsic viscosity for both prolate and oblate spheroids of different ellipticity. Masoumi et al. [16] analyzed the nanofluid as two phase problem and considered the dependence of viscosity of nanofluid on parameters such as temperature, nanoparticle size, nanoparticle volume fraction, nanoparticle density and fluid physical properties. Elena et. al [29], Jisun et. al [30], Gaganpreet and Sunita [31] and recently Maheshwary et. al [32] have outlined the particle's shape effect on the viscosity of nanofluids. Prasher et al [33] Anoop et. al [34] and Jarrah Nejad et. al [35] also reported the particle size effect on the effective viscosity of nanofluids. He et al. [36] demonstrated the increase in viscosity of  $\text{TiO}_2$ /Water nanofluids with the increase in nanoparticle size. Nguyen et. al [37] experimentally studied the effect of particle size and temperature on the dynamic viscosities of  $\text{Al}_2\text{O}_3$ -water(at36nm and 47nm) and CuO-water(at 29nm) nanofluid. Esfe et al. [38] also observed the dependency of the effective viscosity of nanofluid on particle size. Including the effect of agglomeration in predicting the effective viscosity of nanofluid, Suganthi and Rajan [39] presented Einstein's equation with a modified form with agglomerate volume fraction in place of particle volume fraction. Selvakumar and Dhinakaran [40] upgraded Chen et. al model taking into account the effective volume fraction of the cluster along with the interfacial layer. Hosseini et.al [41] put forward an empirical model based on dimensionless groups taking relative viscosity of nanofluids as a function of particle volume fraction, size of the nanoparticle, thickness of the interfacial layer and the temperature apart from the viscosity of the base fluid. Avsec and Oblac [42] derived a new viscosity model with a simple twist to Ward's model and Einstein model [1] by the inclusion of nanolayer interaction. Udawattha et. al [43] proposed a new correlation for the effective viscosity of nanofluids accounting

for the effect of Brownian motion and the interfacial layer on nanoparticle. Most recently Zav'yalov et. al [44] modified Batchelor formula in consistent with experimental data considering the effect of interfacial layer and agglomeration of nanoparticles on the effective viscosity of nanofluids. The above literature and experimental investigations clearly indicates the underprediction of effective viscosity of nanofluids and its dependence on various factors.

### THE PRESENT WORK

The existing models determine the viscosity of nanofluids including the effect of interfacial layer, agglomeration, size and shape of nanoparticles separately. In 2012, Gaganpreet et al [31] proposed unified model for predicting the effective viscosity of nanofluids. They presumed that the particles take the shape of prolate spheroid due to formation of interfacial layer around the particles including their possible agglomeration. Since viscosity is essentially a surface property of the system, the deviation from sphericity of nanoparticles would certainly affect the viscosity of nanofluids. Using the above formulation, Krieger and Dougherty (KD) model has been modified and studied for viscosity of different nanofluid systems. Although the proposed model affirmed good agreement with the experimental data but it was tested with limited samples of Al<sub>2</sub>O<sub>3</sub>-water-based nanofluids. The present work tests the validity of above model for other samples of nanofluids and also includes the effect of size of nanoparticle in predicting the effective viscosity of nanofluids for the given system.

The modified Krieger and Dougherty (KD) model for the relative viscosity of nanofluids is

$$\mu_{eff} = \mu_f \left( 1 - \frac{\phi_{ag}}{\phi_m} \right)^{-[\eta]\phi_m}$$

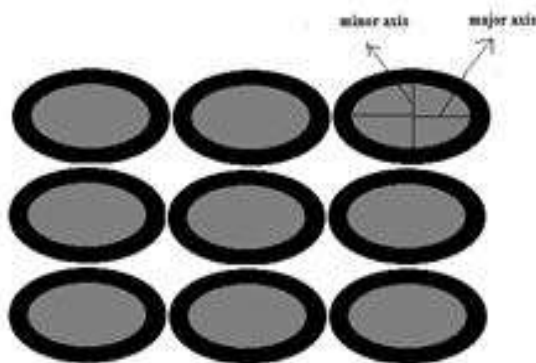
where  $\phi_{ag} = \phi_{eq} \left( \frac{r_a}{r_p} \right)^{3-d_f}$  is the effective volume fraction of nanoparticles that interacts with base fluid to form

aggregates and  $\phi_{eq} = \phi(1 + \delta_{maj})(1 + \delta_{min})^2$  is the volume fraction of nanoparticle along with layer where

$\delta_{min} = \frac{d}{b}$  and  $\delta_{maj} = \frac{d}{a}$ ,  $d$  is the interfacial layer thickness,  $a$  is the semi major axis of the assumed prolate shape of the nanoparticle and  $b$  is its semi-minor axis The morphological structure aggregate of few nanoparticles in the base fluid is shown in figure 1 The maximum possible value of volume fraction for prolate spheroids  $\phi_m$  varies between 0.68 and 0.71 where  $r_a$  is the radius of the aggregates nanoparticles and  $d_f$  measures the change in the packing fraction from the centre to the aggregate edge. Also  $[\eta]$  represents the

intrinsic viscosity given by 
$$[\eta] = \lim_{\phi \rightarrow 0} \frac{\eta - \eta_m}{\eta_m \phi}$$

where  $\eta$  and  $\eta_m$  are the effective viscosities of the suspension and the base fluid respectively. Jeffery [28] had developed a formulation for the viscosity of rigid rod-like particles which could be applied for the prolate shaped nanoparticles and hence calculated the values of intrinsic viscosity  $[\eta]$  for different values of eccentricity.

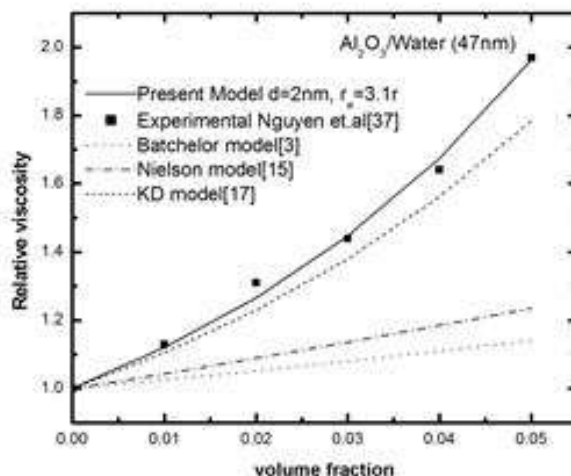


**Figure 1:** The aggregate of nanoparticles when dispersed in the base fluid. The dark region shows the formation of interfacial layer around the nanoparticle

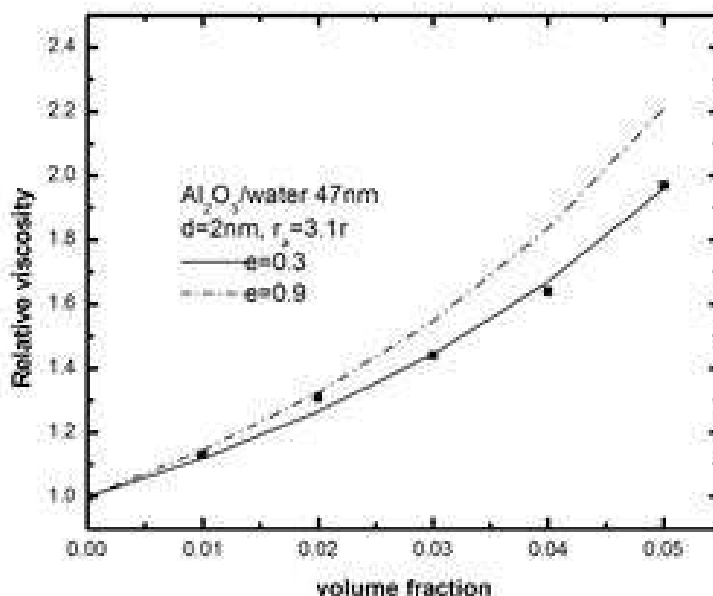


## RESULTS AND DISCUSSION

The present work studied the effect of interfacial layer, aggregation and shape of nanoparticles on effective viscosity of different nanofluids system i.e.  $\text{Al}_2\text{O}_3/\text{water}$ ,  $\text{TiO}_2/\text{water}$ ,  $\text{SiO}_2/\text{EG}$  and  $\text{Cu}/\text{EG}$ . The obtained results are compared with experimental data reported by Nguyen et.al 2007 [37], Murshed et.al 2008 [5], Jamshidi et.al 2012 [20] and Rudyak 2013 [45]. The observed variations in the relative viscosity of nanofluids are shown in the figures 2-6. The relative viscosity of  $\text{Al}_2\text{O}_3/\text{water}$  nanofluid with particle size 47nm,  $3.1r$  radius of aggregation and nano layer thickness of 2nm, is found to be deviated by 3.28% from the experimental result as



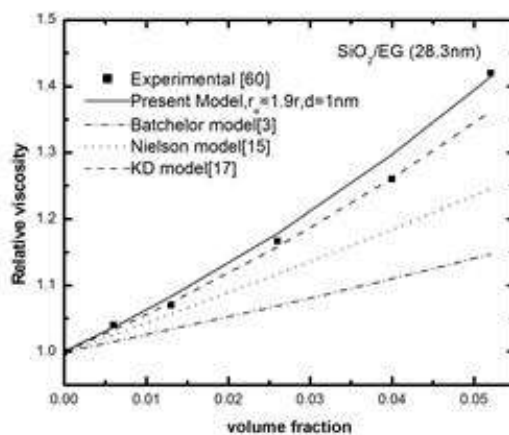
**Figure 2(a):** The variation of relative viscosity with volume fraction for  $\text{Al}_2\text{O}_3/\text{water}$  nanofluid for  $d_p=47\text{nm}$



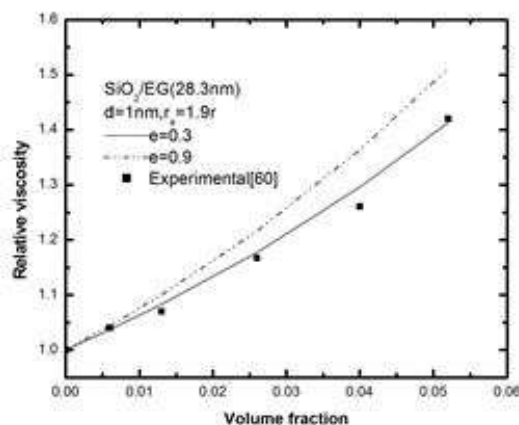
**Figure 2(b):** The variation of relative viscosity with volume fraction for  $\text{Al}_2\text{O}_3/\text{water}$  for different eccentricity compared to 9.6% in case of KD model shown in figure 2(a). Figure 2(b) depicts the values of relative viscosity as a function of volume fraction for different eccentricity values. The values of relative viscosity with eccentricity of 0.3 are in close agreement with the available experimental results for  $\text{Al}_2\text{O}_3/\text{Water}$  that depicts the deviation of nanoparticle shape from sphericity on dispersion.

The figure 3(a) shows the variation of relative viscosity of  $\text{SiO}_2$  nanoparticles (considered spherical) with average radius of 28.3nm dispersed in ethylene glycol. The interfacial layer thickness for this system is found to be 1nm while the radius of aggregates is  $1.9r$ . The mean and maximum deviation in our model are found to be 1.14% and 2.9%, respectively, while the mean and maximum deviation of the KD model was found to be 1.19%

and 4.1%, respectively. The present model has an edge over both Batchelor and Nielson models. For SiO<sub>2</sub>/EG nanofluid, the lower value of eccentricity is found to be in close agreement with the experimental data as shown in figure 3(b).



**Figure 3(a):** The variation of relative viscosity with volume fraction for SiO<sub>2</sub>/EG nanofluid for d<sub>p</sub>=28.3nm



**Figure 3(b):** The variation of relative viscosity with volume fraction for SiO<sub>2</sub>/EG nanofluid for d<sub>p</sub>=28.3nm for different eccentricity

Figure 4(a) shows variation of relative viscosity of TiO<sub>2</sub>/Water nanofluid for nanoparticle size of 15nm. For this system, the thickness of interfacial layer is 1nm while the radius of aggregates is 3.6r. The present model shows a deviation of 13.7% in the relative viscosity of nanofluid while in case of KD model it is 18.6%. The mean deviation in the present and the KD model are 8.8% and 12.7% respectively. The relative viscosity of TiO<sub>2</sub>/Water agrees well with the experimental data shown in figure 4(b) and hence one expects the nanoparticles to eventually acquire the shape of rod like structures

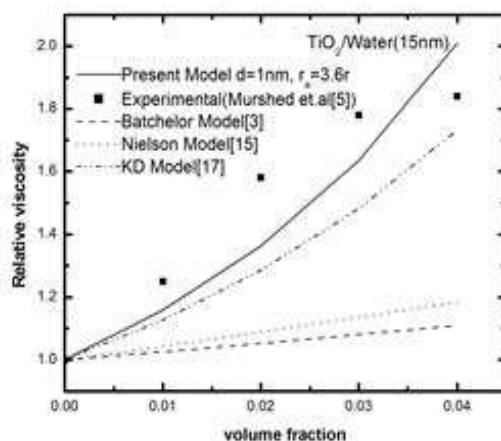


Figure 4(a): The variation of relative viscosity with volume fraction for TiO<sub>2</sub>/water nanofluid for  $d_p = 15\text{nm}$

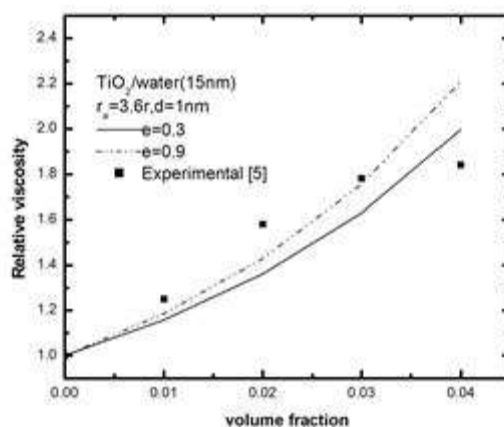


Figure 4(b): The variation of relative viscosity with volume fraction for TiO<sub>2</sub>/water for  $d_p = 15\text{nm}$  for different eccentricity

Figure 5(a) shows the increase in viscosity of Cu/EG nanofluid with an average radius of 200nm. The value of the interfacial layer is 1nm and the radius of aggregates is  $3r$ . The maximum and mean deviation in case of present model are 1.75% and 1.06%, respectively. We observe that the results of the present model are found to agree more or less with that of KD model whereas results of Einstein law, Batchelor model and Nielson model are quite far from the experimental values. Again lower eccentricity value is in agreement with the available experimental values as depicted in figure 5(b).

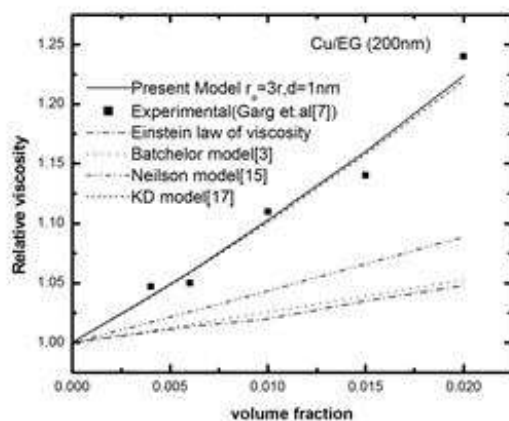
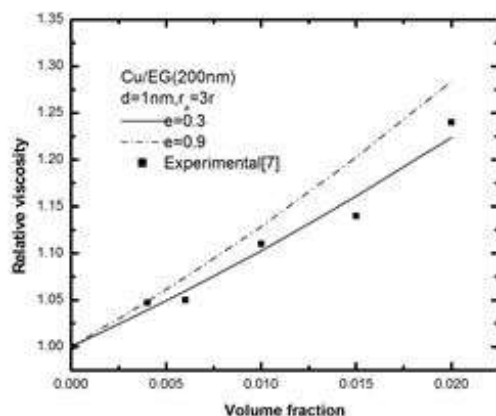
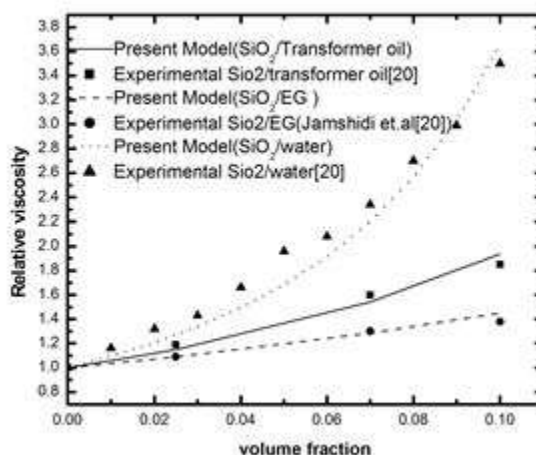


Figure 5(a): The variation of relative viscosity with volume fraction for Cu/EG nanofluid for  $d_p = 200\text{nm}$



**Figure 5(b):** The variation of relative viscosity with volume fraction for Cu/EG for  $d_p=200\text{nm}$  for different eccentricity

The Figure 6 shows the results for the effect of base fluid on the viscosity  $\text{SiO}_2/\text{water}$ ,  $\text{SiO}_2/\text{EG}$  and  $\text{SiO}_2/\text{Transformer oil}$  with nanoparticle size of 10nm. The results have been compared with the experimental results reported by Jamshidi et.al 2012 [20]. The mean and maximum deviations of the present model for  $\text{SiO}_2/\text{water}$  are found to be 3.85% and 4.6%, respectively, and for  $\text{SiO}_2/\text{EG}$  system, these are obtained to be 2% and 5.1% respectively, while for  $\text{SiO}_2/\text{Transformer oil}$  the mean and maximum deviations are calculated to be 6.9% and 14%, respectively.



**Figure 6:** The variation of relative viscosity with volume fraction for  $\text{SiO}_2$  nanofluid systems for  $d_p=10\text{nm}$

## CONCLUSION

The novel concept of deviation of the shape of the nanoparticle from sphericity has been presented for different nanofluid systems. This model gives the better prediction for the effective viscosity of nanofluid systems such as  $\text{Al}_2\text{O}_3/\text{water}$ ,  $\text{TiO}_2/\text{water}$ ,  $\text{SiO}_2/\text{EG}$ ,  $\text{SiO}_2/\text{water}$ ,  $\text{SiO}_2/\text{Transformer oil}$  and  $\text{Cu}/\text{EG}$  and gives the results better than the already existing models put forward by Krieger and Dougherty (KD Model) [17], Neilson [15] and Batchelor [3]. It establishes the fact that the deviation from sphericity of nanoparticle certainly affects the viscosity of nanofluids.

## REFERENCES

1. A. Einstein, Ann. d. Phys., 19, 289–306(1906).
2. H. C Brinkman, J. Chem. Phys., 1952, 20, 4, 571–581(1952).
3. G. K. Batchelor, J. Fluid Mech., 83, 1, 97-117(1977).
4. Lundgren, J. Fluid Mech., 51, 273–299(1972).
5. S. M. S Murshed, K.C Leong and C.Yang, Int. J. of Therm. Sci., 2008, 47, 560-568(2008)

6. F. Duan, D. Kwek and A. Crivoi, *Nanoscale Research Letters*, 2011, 6, 248-252,12(2011).
7. J. Garg, B. Poudel, M. Chiesa, J. B Gordon, J. J Ma, J. B Wang, Z. F. Ren, Y. T. Kang , H. Ohtani, J. Nanda, G. H. McKinley and G. Chen, *J. Appl. Phys.*, 103, 7, 074301-1-074301-6(2008).
8. J. Chevalie, O. Tillement and F Ayela, *Appl. Phys. Lett.*, 91, 23, 1-4(2007).
9. W. Q. Lu and Q. M Fan, *Eng. Anal. Bound. Elem.*, 32, 4, 282-289(2008).
10. X. Phuoc and M. Massoudi, *Int. J. Therm. Sci.*, 48, 7, 1294-1301(2009).
11. W. Duangthongsuk and S. Wongwises., *Exp. Therm. and Fluid Sci.*, 33, 706-714(2009).
12. S. S Guo, Z. Y. Luo, W. Tao, J. F. Zhao, K. F. Cen, *Bulletin of the Chinese Ceramic Society*, 25,5, 52-55(2006).
13. A. L. Graham, *Appl Sci Res*, 37,275-86(1981).
14. N. Frankel and A. Acrivos , *Chem. Eng. Sci.* , 22 ,6, 847-853(1967).
15. L. E. Neilson , *J. of Appl. Phys.*, , 41 (11), 4626- 4627(1970).
16. N Masoumi, N Sohrabi, and A.Behzadmehr, *J. of Phys. D: Applied Physics*, 42, 5, 0555011-0555016(2009).
17. I. M. Krieger , T. Dougherty, *Trans Soc Rheol*, 3,137-152(1959).
18. H. Chen, Y. Ding and C. Tan, *New Journal of Physics*, 9, 367(2007).
19. P.K Namburu , D.P Kulkarni , D.Misra. and D.K Das, *Exp. Therm. and Fluid sci.*, 32, 397-402.(2007).
20. Jamshidi, M. Farhadi, D.D. Ganji, K. Sedighi, *Int. J. Eng. Trans. B* , 25, 201-209(2012).
21. A.V Minakov, V.Y Rudyak , and M.I Pryazhnikov ,*Colloids Surf. A*, 554, 279-288 (2018).
22. M. M Heyhat, F.Kowsary , A.M.M Rashidi, M.H. Memenpour, A.Amrollah and M.H Momenpour , *Exp. Therm. and Fluid Sci.*, 44, 483-489(2013).
23. M Sharifpur , S.A Adio ,J.P Meyer., *Int Commun Heat Mass Transf.*,68, 208-219(2015).
24. H. W. Chiam, W. H. Azmi, N. A. Usri, R. Mamat, N. M. Adam, *Exp. Therm. Fluid Sci.*,420-429(2017).
25. M. Akbari , M. Afrand , A. Arshi , A. Karimipour *J. Mol Liq.* 233, 352-357 (2017).
26. M. Dhahri , H. Aouinet, H. Sammouda, *Heat Transfer—Asian Res.*, 48, 1547-1562(2019).
27. E. V. Timofeeva, J. L. Routbort and D. Singh, *J. of Appl. Phys.*, 2009 ,106, 1, 014304-1 – 10(2009).
28. G.B Jeffery, *Proceedings of the Royal Society A: Mathematical, Physical and Engineering Sciences*, 102, 715, 161-179(1922).
29. V. T Elena, L. R Jules, S. Dileep, *J. Appl. Phys.* 106, 1-11(2009).
30. J. Jisun , Li Chengguo , K. Younghwan , *Int J Refrig.* 36, 2233-224(,2013).
31. Gaganpreet and S. Srivastava , *Appl. Nanosci.*, 2, 325-331(2012)
32. P. B Maheshwary, C. C Handa, K. R. A Nemade., *Appl Therm Eng.*,119, 79-88(2017).
33. R. Prasher, S. David, W. Jinlin, P. Patrick . *Appl Phys Lett.* 89, 1-4(2006).
34. K. B Anoop, T. Sundararajan, K. D Sarit, *Int J Heat Mass Transfer.*, 52, 2189-2195,2009.
35. M. J. Nejad, E. B. Haghghi, M. Saleemi, *Rheol Acta.* , 54, 411-422(2015).
36. He, Y. Jin, H. Chen, Y. Ding, D. Cang and H. Lu, *Int. J. Heat Mass Transf.*, 50, 11-12, 2272-2281(2007).
37. C. Nguyen, F. Desgranges, G. Roy, N Galanis, T. Mare, S. Boucher, H. A. Mintsa, *Int J Heat Fluid Flow*, 28,1492-506(2007).
38. Esfev Hemmat, S. Saedodin, O. Mahian, and S. Wongwises, *Int. Commun. Heat Mass Transf.*, 58, 138-146(2014)
39. K. S. Suganthi and K. S. Rajan, *Int. J. of Heat and Mass Trans.*, 55, 25-26, 7969-7980,2012.

40. R. D. Selvakumar, S. Dhinakaran, *J. of Mol. Liq.*, 225, 20-27(2016).
41. S. M Hosseini, A. R. Moghadassi and D. E. Hennek, *J. Therm., Anal. Calorim.*, 100, 873-877(2010) .
42. J. Avsec, M. Oblak, *Int. J. Heat Mass Transf.*, 50, 21, 4331–4341(2007).
43. D. S. Udawaththa, M. Narayana, U. P. L Wijayarathna, *Journal of King Saud University - Science*, 31, 3, 412-426(2019).
44. A. P. Zavyalov, V. VSyzrantsev, K.V Zobo and S. P. Bardakhanov, *J. of Eng. Phys. and Therm.*, 91,1,123-132(2018)
45. I. M. Mahbubul, M. A. Saidur, *Int J Heat Mass Transf*, 55, 874–85(2012)
46. C. Nguyen, F. Desgranges ,G. Roy, N. Galanis, T. Mare, S. Boucher, H. A. Mintsa, *Int J Therm Sci*, 47, 103–111(2008).
47. P. C. Mishra, S. Mukherjee, S. K. Nayak, A. Panda, *Int Nano Lett.*, 2014, 4, 109–20.
48. P. N Nwosu, J. P. Meyer, M. Sharifpur, *J Heat Transf.*, 5, 031008(2014).
49. A. K. Sharma, A. K. Tiwari, A. R. Dixit, *Renew Sustain Energy Rev*, 53, 779–91(2016)
50. S. Thomas, C. B. P Sobhan, *Nano Res Lett*, 6, 377-398(2011)
51. R. Pal, *Fluids* 1, 2, 11–20(2016).
52. N. S. Cheng, A.W.K. Law, *Powder Technol.*, 12, 1, 156–160(2003).
53. L. Chen, H. Xie H, W. Yu, Y. Li, *J Dispers Sci Technol.*, 32, 550-554(2011).
54. N. I. M. Mahbubul, R. Saidur, M. A. Amalina, *Int. J. Heat Mass Transf.*, 55, 874–885(2012).
55. M. Chandrasekar, S. Suresh, A. C. Bose, *Exp Therm Fluid Sci.*, 34, 210–216(2010).
56. P. K. Namburu, D. K. Das, K. M. Tanguturi, R. S. Vajjha, *Int J Ther Sci.*, 48, 290-302(2009).
57. A.V. Minakov, V. Ya. Rudyak and M. I. Pryazhnikov, *Heat Transfer Engineering*, 42, 12, 1024-1040(2021).
58. R. Pal, *J. Nanofluids*, 3, 260–266(2014).
59. A. K. Patra et al., *Int. J. of Therm. Science and Technology*, 7, 2, Paper No. 070202(2020)
60. V. Y. Rudyak, *Advances in Nanoparticles*, 2, 266-279 (2013).

## A Comparative Analysis of Antioxidant Activities in *Caralluma Indica* Stem, *Phoenix Pusilla* Leaves and *Sansevieria Roxburghiana* Leaves Extracts

A. Satish, S. Durgadevi and A. Leema Rose

PG and Research Department of Chemistry, Holy Cross College (Autonomous) (Affiliated to Bharathidasan University), Tiruchirappalli, Tamil Nadu, India

### ABSTRACT

The present study was carried out to evaluate the antioxidant activities of *Caralluma indica* stem, *Phoenix pusilla* leaves and *Sansevieria roxburghiana* leaves. The antioxidant activity of different concentrations (20, 40, 60, 80 and 100 µg/ml) of these three medicinal plants was evaluated by various in vitro models such as reducing ability, free radical scavenging activity by DPPH, superoxide anion scavenging, hydroxyl radical scavenging, hydrogen peroxide scavenging, nitric oxide scavenging, Fe<sup>2+</sup> chelating and reducing power assay. The effects were comparable with the standard antioxidant ascorbic acid. The results of the study showed that antioxidant properties were observed in concentration-dependent. Among the various plants, ethanol extract of leaf powder of *Sansevieria roxburghiana* exhibited higher antioxidant potential followed by *Phoenix pusilla* leaves and *Caralluma indica* stem. These results demonstrate that ethanolic extracts and their derived phytochemicals of plant extracts have excellent antioxidant activities and thus they have great potential as sources for natural health products.

Keywords: *Caralluma indica*, *Phoenix pusilla*, *Sansevieria roxburghiana*, Antioxidant.

### INTRODUCTION

Oxidation is a major problem in many areas like human health, food producers and so on. Oxidation is caused by various elements one of which is free radicals namely nitric oxide, hydrogen peroxide and superoxide. The oxidation in metal triggers a serious problem called corrosion in industrial sectors. They are mostly seen in industries that work in corrosive environments like salt surfaces (ships), and food processing industries [1,2]. The substance which inhibits the oxidation process is called an antioxidant. Natural antioxidants have the property of protecting the human body from the damaging effects of free radicals. Natural antioxidants inhibit the progress of many chronic as well as retard lipid oxidation activity in foods and pharmaceuticals. The secondary metabolites like phenolic and flavonoids from plants have been reported to be potent free radical scavengers. They are found in all parts of plants such as leaves, fruits, seeds, roots and bark [3].

Traditional medicine from plant extracts has proved to be clinically effective and relatively less toxic than the existing drugs [4]. Successful determination of biologically active compounds from plant material is largely dependent on the type of solvent used in the extraction procedure [5]. Free radicals have the capacity to damage the biological molecules like proteins, lipids, DNA, carbohydrates etc. Free radicals are also responsible for cellular damage and homeostatic disruption [6]. A number of confirmations suggests that the biological actions of these compounds are related to their antioxidant activity [7]. Reactive oxygen species have their role in the complications associated with diabetes mellitus and other neurological diseases like Parkinson's disease [8]. Out of various natural antioxidants, phenolic compounds are reported to be more active [9]. The present study has been conducted to evaluate the comparative antioxidant properties of *Caralluma indica* stem, *Phoenix pusilla* leaves and *Sansevieria roxburghiana* leaves.

### MATERIALS AND METHOD

#### Collection and Preparation of alcoholic extract

The *Caralluma indica* stem, *Phoenix pusilla* leaves and *Sansevieria roxburghiana* leaves were collected from Sengipatti, Thanjavur, Tamil Nadu. The collected plant parts were shade dried and make a fine powder using a mixer grinder. 10grams of *Caralluma indica* stem, *Phoenix pusilla* leaves and *Sansevieria roxburghiana* leaves powder were used for extraction. Extraction was performed with cold extraction using the maceration method into ethanol solvent for 24 hours using the "intermittent shaking" method to obtain an extract. The extract was filtered using Whatman filter No 1 paper and filtrate was used for *in vitro* antioxidant assay.

#### In vitro antioxidant activity

DPPH radical-scavenging activity was determined by the method of Shimada, *et al.*, [10]. The superoxide anion radicals scavenging activity was measured by the method of Liu *et al.* [11]. The scavenging activity for hydroxyl and hydrogen peroxide radicals were measured with Fenton reaction by the method of Yu *et al.* [12] and Ruch *et al.* [13] respectively. Nitric oxide radical scavenging activity was determined according to the

method reported by Garrat [14]. The metal chelating activity of the extract was assayed by Dinis *et al.* [15] method. The iron<sup>+</sup> reducing power of the extract was determined by the method of Oyaizu [16].

### STATISTICAL ANALYSIS

Tests were carried out in triplicates for 3 separate experiments. The amount of sample needed to inhibit free radicals concentration by 50%, IC<sub>50</sub>, was graphically determined by a linear regression method using Ms-Windows based graphpad InStat (version 3) software. Results were expressed as graphically/ mean ± standard deviation.

### RESULTS AND DISCUSSION

The use of plants as antioxidants and green inhibitors is a huge topic of discussion by many around the world. A major search for natural and green products are taken seriously as it has numerous benefits than any other man-made product to prevent oxidation and corrosion.

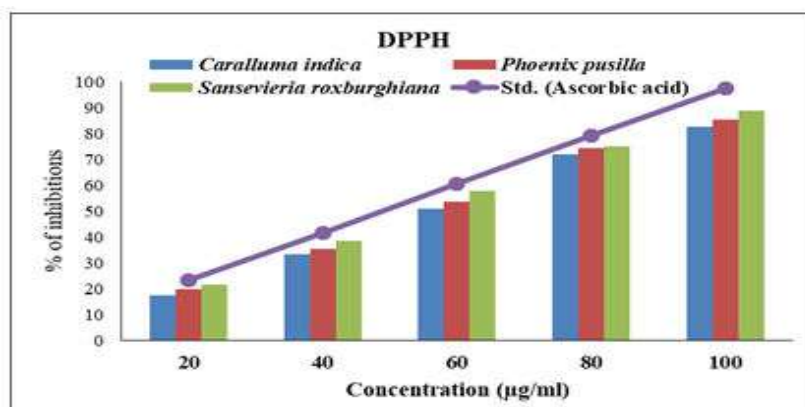
#### DPPH radical scavenging activity

The DPPH test showed the ability of the test compound to act as a free radical scavenger. DPPH assay method is based on the ability of 1, 1- diphenyl-2-picrylhydrazyl (DPPH), a stable free radical, to decolourize in the presence of antioxidants. DPPH, a protonated radical, has a characteristic absorbance maximum at 517 nm, which decreases with the scavenging of the proton radical. This property has been widely used to evaluate the free radical scavenging effect of natural antioxidants. When DPPH radical is scavenged, the colour of the reaction mixture changes from purple to yellow with decreasing of absorbance at a wavelength 517nm. Figure 1 represents DPPH radical scavenging activity of *Caralluma indica* stem, *Phoenix pusilla* leaves and *Sansevieria roxburghiana* leaves extract and compared with Ascorbic acid. DPPH scavenging was increased in a concentration-dependent manner compared to ascorbic acid, used as the positive antioxidant control in this investigation. The half inhibition concentration (IC<sub>50</sub>) of *C. indica* stem, *P. pusilla* leaves, *S. roxburghiana* leaves extract and ascorbic acid were 58.50µg/ml, 55.79µg/ml, 52.56µg/ml and 48.68µg/ml respectively (Table. 1). The lower IC<sub>50</sub> value has higher antioxidant activity.

**Table 1:** Dpph Radical Scavenging Activity of Caralluma Indica Stem, Phoenix Pusilla Leaves, Sansevieria Roxburghiana Leaves Extract and Compared With Ascorbic Acid

Concentrations (µg/ml)	% of inhibitions			
	<i>Caralluma indica</i>	<i>Phoenix pusilla</i>	<i>Sansevieria roxburghiana</i>	Std. (Ascorbic acid)
20	17.44±0.72	19.95±0.63	21.49±0.56	23.48±1.34
40	33.25±0.58	35.42±0.74	38.51±0.71	41.75±0.98
60	50.93±0.98	53.79±0.76	57.85±0.69	60.48±0.79
80	72.04±1.37	74.51±1.89	75.09±1.25	79.31±1.18
100	82.65±1.09	85.47±1.29	88.93±1.77	97.49±0.94
IC <sub>50</sub> (µg/ml)	58.50	55.49	52.56	48.68

Values expressed as Mean ± SD for triplicates



**Figure 1:** DPPH radical scavenging activity of Caralluma indica stem, Phoenix pusilla leaves, Sansevieria roxburghiana leaves extract and compared with Ascorbic acid

#### Superoxide Scavenging Activity

It is well known that superoxide anions damage biomolecules directly or indirectly by forming H<sub>2</sub>O<sub>2</sub>, <sup>-</sup>OH, peroxy nitrite or singlet oxygen during ageing and pathological events such as ischemic reperfusion injury.

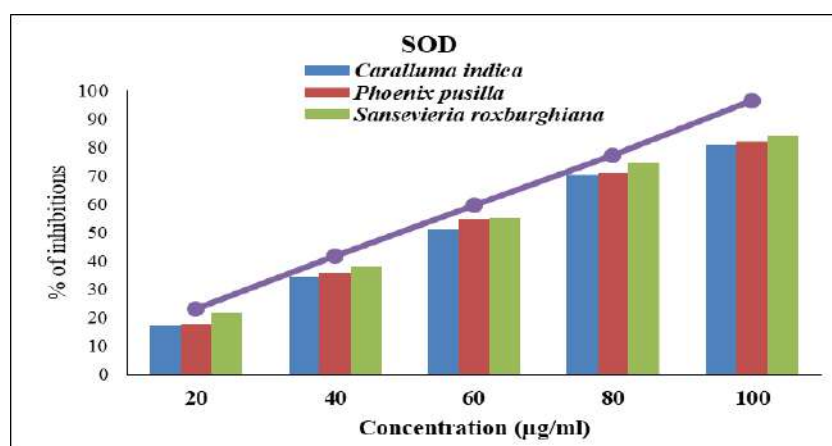


Superoxide has also been observed to directly initiate lipid peroxidation. Superoxide scavenging activity of *Caralluma indica* stem, *Phoenix pusilla* leaves, *Sansevieria roxburghiana* leaves extract investigated and compared with Ascorbic acid. The half inhibition concentration (IC<sub>50</sub>) of *C. indica* stem, *P. pusilla* leaves, *S. roxburghiana* leaves extract and ascorbic acid were 58.97µg/ml, 57.18µg/ml, 54.09µg/ml and 49.44µg/ml respectively (Table 2 and Figure 2).

**Table 2:** Superoxide Scavenging activity of *Caralluma indica* stem, *Phoenix pusilla* leaves, *Sansevieria roxburghiana* leaves extract and compared with Ascorbic acid

Concentrations (µg/ml)	% of inhibitions			
	<i>Caralluma indica</i>	<i>Phoenix pusilla</i>	<i>Sansevieria roxburghiana</i>	Std. (Ascorbic acid)
20	17.29±0.93	17.53±0.86	21.86±0.73	23.01±0.59
40	34.63±0.85	35.92±0.94	37.93±0.89	41.58±0.79
60	51.07±1.02	54.79±0.81	55.29±1.06	59.73±1.27
80	70.25±1.34	71.15±1.29	74.57±1.47	77.35±1.35
100	80.93±1.28	82.19±1.32	84.15±1.35	96.66±1.01
IC <sub>50</sub> (µg/ml)	58.97	57.18	54.09	49.44

Values expressed as Mean ± SD for triplicates



**Figure 2:** Superoxide Scavenging activity of *Caralluma indica* stem, *Phoenix pusilla* leaves, *Sansevieria roxburghiana* leaves extract and compared with Ascorbic acid

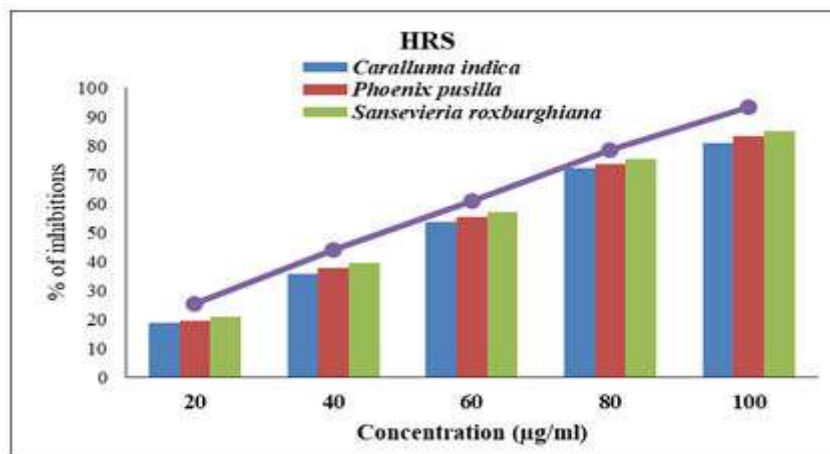
### Hydroxyl radical scavenging activity

Hydroxyl radical is highly reactive oxygen centered radical formed from the reaction of various hydroperoxides with transition metal ions. It attacks proteins, DNA, polyunsaturated fatty acid in membranes, and most biological molecule it contacts and is known to be capable of abstracting hydrogen atoms from membrane lipids and brings about peroxidic reaction of lipids. Plant extracts exhibited concentration dependent scavenging activity against hydroxyl radical generated in the Fenton reaction system. Figure 3 noticed the hydroxyl radical scavenging activity of *Caralluma indica* stem, *Phoenix pusilla* leaves, *Sansevieria roxburghiana* leaves extract and compared with Ascorbic acid. The half inhibition concentration (IC<sub>50</sub>) of *C. indica* stem, *P. pusilla* leaves, *S. roxburghiana* leaves extract and ascorbic acid were 57.12µg/ml, 55.18µg/ml, 53.21µg/ml and 47.72µg/ml respectively (Table 3).

**Table 3:** Hydroxyl radical scavenging activity of *Caralluma indica* stem, *Phoenix pusilla* leaves, *Sansevieria roxburghiana* leaves extract and compared with Ascorbic acid

Concentrations (µg/ml)	% of inhibitions			
	<i>Caralluma indica</i>	<i>Phoenix pusilla</i>	<i>Sansevieria roxburghiana</i>	Std. (Ascorbic acid)
20	18.79±0.79	19.45±0.81	20.93±0.95	25.48±0.65
40	35.84±0.87	37.91±0.99	39.49±1.05	43.95±0.71
60	53.67±1.18	55.28±1.14	57.01±1.35	61.02±1.19
80	72.19±1.09	73.84±1.25	75.35±1.29	78.51±1.34
100	81.05±0.98	83.19±1.01	85.06±1.18	93.18±0.95
IC <sub>50</sub> (µg/ml)	57.12	55.18	53.21	47.72

Values expressed as Mean ± SD for triplicates



**Figure 3:** Hydroxyl radical scavenging activity of *Caralluma indica* stem, *Phoenix pusilla* leaves, *Sansevieria roxburghiana* leaves extract and compared with Ascorbic acid

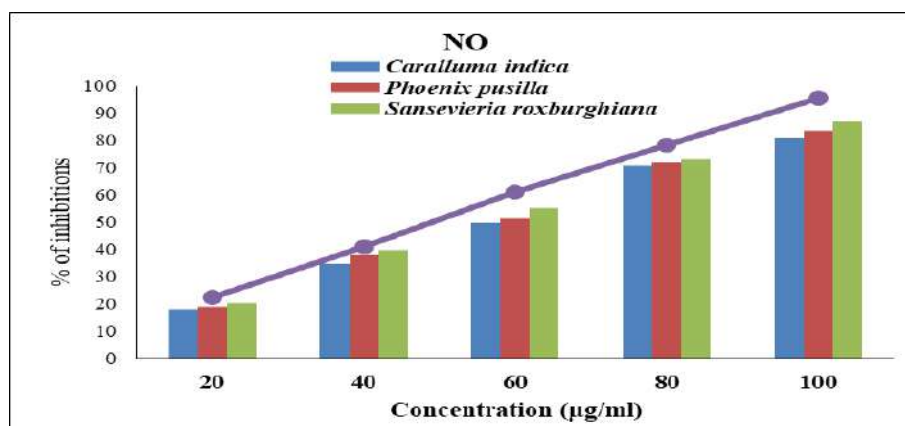
### Nitric oxide scavenging activity

NO is a potentially toxic agent with a free radical character and therefore it is responsible for many physiologic and pathologic events. Figure 4 noticed the nitric oxide scavenging activity of *Caralluma indica* stem, *Phoenix pusilla* leaves, *Sansevieria roxburghiana* leaves extract and compared with Ascorbic acid. The half inhibition concentration ( $IC_{50}$ ) of *C. indica* stem, *P. pusilla* leaves, *S. roxburghiana* leaves extract and ascorbic acid were 58.82 µg/ml, 56.57 µg/ml, 53.82 µg/ml and 49.43 µg/ml respectively (Table 4).

**Table 4:** Nitric oxide scavenging activity *Caralluma indica* stem, *Phoenix pusilla* leaves, *Sansevieria roxburghiana* leaves extract and compared with Ascorbic acid

Concentrations (µg/ml)	% of inhibitions			
	<i>Caralluma indica</i>	<i>Phoenix pusilla</i>	<i>Sansevieria roxburghiana</i>	Std. (Ascorbic acid)
20	18.03±0.65	18.94±0.87	20.43±0.71	22.37±0.47
40	35.01±0.71	37.85±0.91	39.71±0.95	40.98±0.81
60	49.68±1.47	51.47±0.79	55.39±1.26	61.07±0.63
80	70.86±0.86	72.18±1.07	73.18±1.19	78.49±0.96
100	81.17±1.26	83.55±1.19	87.01±1.08	95.71±0.78
$IC_{50}$ (µg/ml)	58.82	56.57	53.82	49.43

Values expressed as Mean ± SD for triplicates



**Figure 4:** Nitric oxide scavenging activity of *Caralluma indica* stem, *Phoenix pusilla* leaves, *Sansevieria roxburghiana* leaves extract and compared with Ascorbic acid

### Iron chelating activity

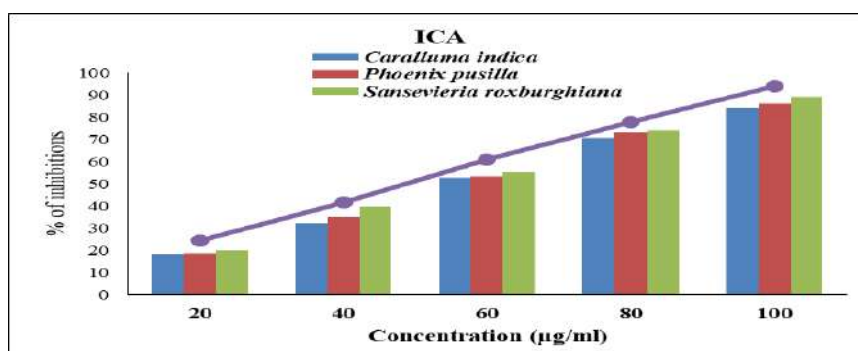
Ferrozine can quantitatively form complexes with  $Fe^{2+}$ . However, in the presence of chelating agents, the complex formation is disrupted with the result that the red colour of the complex is decreased. Measurement of colour reduction, therefore, allows the estimation of the chelating activity of the coexisting chelator. The main strategy to avoid ROS generation that is associated with redox active metal catalysis involves chelating of the

metal ions. Figure 5 noticed the iron chelating activity of *Caralluma indica* stem, *Phoenix pusilla* leaves, *Sansevieria roxburghiana* leaves extract and compared with Ascorbic acid. The half inhibition concentration (IC<sub>50</sub>) of *C. indica* stem, *P. pusilla* leaves, *S. roxburghiana* leaves extract and ascorbic acid were 58.82µg/ml, 56.57µg/ml, 53.82µg/ml and 49.43µg/ml respectively (Table 5).

**Table 5:** Iron chelating activity of *Caralluma indica* stem, *Phoenix pusilla* leaves, *Sansevieria roxburghiana* leaves extract and compared with Ascorbic acid

Concentrations (µg/ml)	% of inhibitions			
	<i>Caralluma indica</i>	<i>Phoenix pusilla</i>	<i>Sansevieria roxburghiana</i>	Std. (Ascorbic acid)
20	18.01±0.45	18.65±0.55	19.76±0.85	24.25±0.63
40	32.19±0.72	35.22±0.67	39.54±0.95	41.62±0.79
60	52.76±0.81	53.19±0.93	55.32±1.02	60.75±1.37
80	70.61±0.65	73.15±0.91	74.09±1.55	77.93±1.08
100	84.05±1.09	86.07±1.34	89.19±0.87	94.09±0.79
IC <sub>50</sub> (µg/ml)	58.21	56.22	53.56	48.94

Values expressed as Mean ± SD for triplicates



**Figure 5:** Iron chelating activity of *Caralluma indica* stem, *Phoenix pusilla* leaves, *Sansevieria roxburghiana* leaves extract and compared with Ascorbic acid

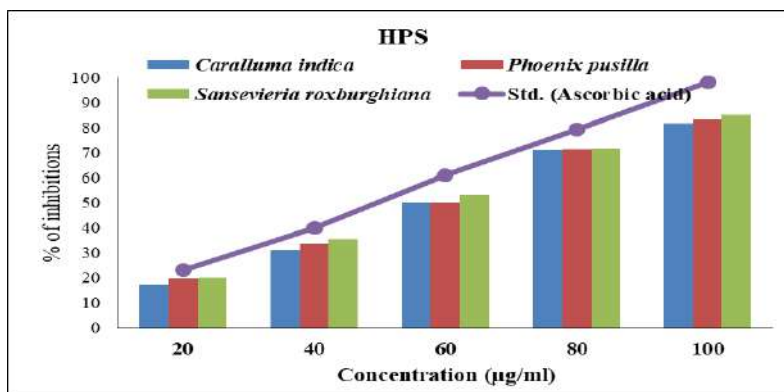
### Hydrogen peroxide scavenging activity

The naturally occurring of H<sub>2</sub>O<sub>2</sub> in the air, water, human body, plants, microorganisms and food is at low concentration levels. Hydrogen peroxide is a weak oxidizing agent and can inactivate a few enzymes directly, usually by oxidation of essential thiol (-SH) groups. Hydrogen peroxide can cross cell membranes rapidly, once inside the cell, H<sub>2</sub>O<sub>2</sub> can probably react with Fe<sup>2+</sup>, and possibly Cu<sup>2+</sup> ions to form hydroxyl radical and this may be the origin of many of its toxic effects. It is, therefore, biologically advantageous for cells to control the amount of hydrogen peroxide that is allowed to accumulate. Cells make the enzyme catalase to remove hydrogen peroxide. Different plant materials show different amounts of catalase activity. Hydrogen peroxide scavenging activity depends upon the phenolic content of the extract, which can donate electrons to H<sub>2</sub>O<sub>2</sub> and thereby neutralizing it in to water. The decomposition of H<sub>2</sub>O<sub>2</sub> by *Caralluma indica* stem, *Phoenix pusilla* leaves and *Sansevieria roxburghiana* leaves may at least partly result from its antioxidant and free radical scavenging activity which may be attributed to the presence of phenolic groups that could donate electrons to hydrogen peroxide, thereby neutralizing it into H<sub>2</sub>O. The half inhibition concentration (IC<sub>50</sub>) of *C. indica* stem, *P. pusilla* leaves, *S. roxburghiana* leaves extract and ascorbic acid were 59.81µg/ml, 57.99µg/ml, 56.25µg/ml and 49.05µg/ml respectively (Table 6 and figure 6).

**Table 6:** Hydrogen peroxide scavenging activity of *Caralluma indica* stem, *Phoenix pusilla* leaves, *Sansevieria roxburghiana* leaves extract and compared with Ascorbic acid

Concentrations (µg/ml)	% of inhibitions			
	<i>Caralluma indica</i>	<i>Phoenix pusilla</i>	<i>Sansevieria roxburghiana</i>	Std. (Ascorbic acid)
20	17.33±0.71	19.54±0.55	20.17±0.63	23.14±0.89
40	30.95±0.68	33.79±0.78	35.42±0.71	40.09±0.81
60	50.01±0.94	50.17±0.69	53.05±0.88	61.11±0.79
80	70.92±1.04	71.31±1.19	71.64±0.95	79.27±1.03
100	81.55±1.15	83.49±1.09	85.31±1.24	98.15±0.95
IC <sub>50</sub> (µg/ml)	59.81	57.99	56.25	49.05

Values expressed as Mean ± SD for triplicates



**Figure 6:** Hydrogen peroxide scavenging activity of *Caralluma indica* stem, *Phoenix pusilla* leaves, *Sansevieria roxburghiana* leaves extract and compared with Ascorbic acid

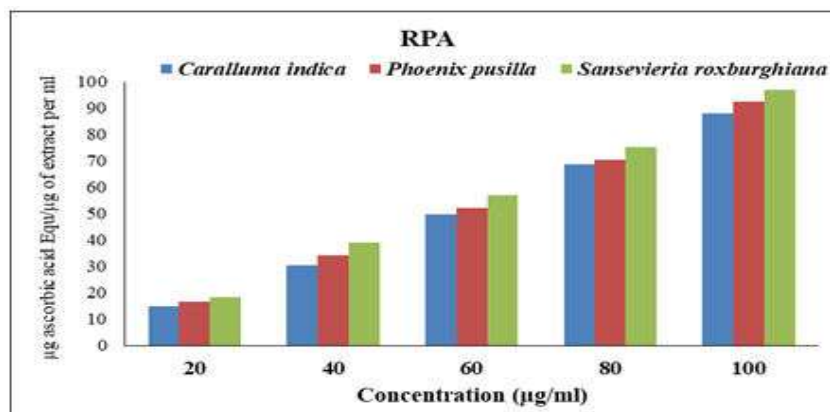
### REDUCING POWER ACTIVITY

The ability of extract to reduce  $Fe^{+3}$  to  $Fe^{+2}$  (reducing effect) transformation was investigated in the presence of plant extracts. The reducing capacity of a compound may serve as a significant indicator of its potential antioxidant activity. However, the activity of antioxidants has been assigned to various mechanisms such as prevention of chain initiation, binding of transition metal ion catalysts, decomposition of peroxides, prevention of continued hydrogen abstraction, reductive capacity, and radical scavenging. Plant extract with reducing power indicate that they are electron donors and can reduce the oxidized intermediates of lipid peroxidation processes, so that they can act as primary and secondary antioxidants. The results were expressed as  $\mu g$  ascorbic acid equ/ $\mu g$  extract per ml. The antioxidant activity, the reducing power of extracts increased with increasing dosage (Table 6 and Figure 6). The result shows that extracts consist of hydrophilic polyphenolic compounds that cause the greater reducing power.

**Table 7:** Reducing power activity of *Caralluma indica* stem, *Phoenix pusilla* leaves, *Sansevieria roxburghiana* leaves extract and compared with Ascorbic acid

Concentrations (µg/ml)	µg ascorbic acid Equ/µg of extract per ml		
	<i>Caralluma indica</i>	<i>Phoenix pusilla</i>	<i>Sansevieria roxburghiana</i>
20	14.89±0.43	16.62±0.37	18.36±0.33
40	30.36±0.39	34.22±0.41	39.02±0.46
60	49.56±0.35	52.09±0.39	56.76±0.37
80	68.62±0.47	70.22±0.45	75.29±0.41
100	88.09±0.41	92.36±0.43	96.89±0.42

Values expressed as Mean ± SD for triplicates



**Figure 7:** Reducing power activity of *Caralluma indica* stem, *Phoenix pusilla* leaves, *Sansevieria roxburghiana* leaves extract and compared with Ascorbic acid

The *in vitro* antioxidant activity of *Caralluma indica* stem, *Phoenix pusilla* leaves, *Sansevieria roxburghiana* leaves extract tested using various *in vitro* model. Among the various *Sansevieria roxburghiana* leaves extract

has potential antioxidant activity followed by *Phoenix pusilla* leaves and *Caralluma indica* stem extracts. Oxidative stress plays an important role in the development and pathophysiology of many diseases [17]. This method is one of the most popular procedures to test the antioxidant potential of a plant extract. DPPH is a relatively stable radical that acts as an antioxidant or free radical scavenger by donating hydrogen ions to the compounds in the oxidised state [18].

The neutral form of a hydroxide ion ( $\text{OH}^-$ ) is a hydroxyl radical and is highly reactive. Therefore, it exists only for a short period. Several biological membranes including DNA can be damaged by hydroxyl radicals. To neutralise this radical, no endogenous enzymatic scavenging pathways are present inside the body and most often it is neutralised by several endogenous molecules such as glutathione, melatonin and antioxidants supplemented through diet [19]. Nitric oxide (NO), which is an important bioactive molecule, possesses several physiological functions [20]. Based on the antioxidant activity exhibited by various plant extracts, many plants with amino compounds have been shown to be effective sources of anticorrosion. Plants like *Celosia argentea*, *Mentha pulegium*, *Datura metel*, *Phyllanthus amarus*, and *Pterolobium hexapetalum* have been recognized as good anticorrosive materials due to the presence of amino compounds in the phenols and flavonoids [21].

The inhibition ability of the plant extracts was generally attributed to the presence of naturally phytochemical compounds which have antioxidant properties [22 -24]. It has also been found that plant components (biopolymers, proteins, flavonoids, and alkaloids) exhibit effective inhibitory activity based on their antioxidant activity derived from their structure. Beside the antioxidant and free radical scavenging activity, plants extracts became also a target for the discovery of natural inhibitors of steel corrosion [25-27].

Importantly, the correlation between antioxidant/free radical scavenging activity of the extracts and the inhibition action was observed [26]. The anticorrosion and antioxidant activity of a plant extract is affected by the extraction method and the solvent used, since the extraction procedure strongly influence the composition of the extract. However, due to the large variety of molecules contained in natural extracts, the inhibition mechanisms remain largely unknown. As for as the availability of review articles on plants extracts and they antioxidant and anticorrosive property and correlation between antioxidant or free radical scavenging activity of the extracts and they inhibition action was not found. It is important to mention that in certain cases, authors wonder about the correlation between the antioxidant and antiradical capacities of the plant extract.

According to some authors, the action mechanism of antioxidant and anticorrosive additives can be interpreted by terminating oxygen radical reaction and passivating film theory. The performance measurement of the antioxidant and anticorrosive influence are reported in many kinds of literature, but its correlation study and overviews are little relatively. A similar work published in literature has not been found up to now. In the new publications presented in 2019 [28], the antioxidant and antiradical capacities of the water-soluble fraction (WSF) and a water-insoluble fraction (WIF) from the *Pine radiata* bark extracts were determined to identify which of the two is more effective as an organic corrosion inhibitor. Several authors have performed these determinations for medical applications, but never for the relationship between the antioxidant and anticorrosive capacities [29-31].

## CONCLUSION

Over all it can be concluded that *Sansevieria roxburghiana* leaves extract has potential antioxidant activity followed by *Phoenix pusilla* leaves and *Caralluma indica* stem extracts. The plant extracts contain several phytochemicals constituents that can easily adsorb and prevent oxidation. The antioxidant properties of the plant extract may be explained by the antioxidant properties. The correlation dependence of the increase in the degree of corrosion protection with an increase in total antioxidant capacity or antioxidant or free radical scavenging activity of the extracts. Thus, higher inhibitory effects of the extracts on radical anion formation noted herein possibly render them as a promising antioxidant. The antioxidant proper of plant extracts positive approach to study the anticorrosive activity.

## REFERENCES

1. Gudze M.T.; Melchers R.E. Operational Based Corrosion Analysis in Naval Ships. *Corros. Sci.*, 2008, 50, 3296-3307.
2. Jullien C.; Benezech T.; Carpentier B.; Leuret V.; Faille C. Identification of Surface Characteristics Relevant to the Hygienic Status of Stainless Steel for the Food Industry. *J. Food Eng.*, 2003, 56, 77-87
3. Mathew, S., & Abraham, T. E. (2006). In vitro antioxidant activity and scavenging effects of *Cinnamomum verum* leaf extract assayed by different methodologies. *Food and Chemical Toxicology*, 44(2), 198-206.

4. Awaad, A. S., El-Meligy, R. M., Qenawy, S. A., Atta, A. H., & Soliman, G. A. (2011). Anti-inflammatory, antinociceptive and antipyretic effects of some desert plants. *Journal of Saudi Chemical Society*, 15(4), 367-373.
5. Govindarajan, R., Vijayakumar, M., & Pushpangadan, P. (2005). Antioxidant approach to disease management and the role of 'Rasayana'herbs of Ayurveda. *Journal of ethnopharmacology*, 99(2), 165-178.
6. Pacifici, R. E., & Davies, K. J. (1991). Protein, lipid and DNA repair systems in oxidative stress: the free-radical theory of aging revisited. *Gerontology*, 37(1-3), 166-180.
7. Gryglewski, R. J., Korbut, R., Robak, J., & Święć, J. (1987). On the mechanism of antithrombotic action of flavonoids. *Biochemical pharmacology*, 36(3), 317-32
8. Oyedemi, S. O., Bradley, G., & Afolayan, A. J. (2010). In-vitro and-vivo antioxidant activities of aqueous extract of *Strychnos henningsii* Gilg. *African Journal of pharmacy and pharmacology*, 4(2), 070-078.
9. Yingming, P., Ying, L., Hengshan, W., & Min, L. (2004). Antioxidant activities of several Chinese medicine herbs. *Food chemistry*, 88(3), 347-350.
10. Shimada K, Fujikawa K, Yahara K, & Nakamura T. (1992). Antioxidative properties of xanthum on the autoxidation of soybean oil in cyclodextrin emulsion. *Journal of Agricultural and Food Chemistry*, 40: 945-948.
11. Liu, F., Ooi, C. V. E., & Chang, S. T. (1997). Free radical scavenging activity of mushroom polysaccharide extracts. *Life Sci.*, 60, 763-771.
12. Yu F, Yu F, Li R and Wang R. (2004) Inhibitory effects of the *Gentiana macrophylla* extract on srheumatoid arthritis of rats. *J. Ethnopharmacol.* 95: 77-81.
13. Ruch, R. J., Cheng, S. J., & Klaunig, J. E. (1989). Prevention of cytotoxicity and inhibition of intracellular communication by antioxidant catechins isolated from Chinese green tea. *Carcinogenesis*, 10, 1003-1008.
14. Garrat D.C. *The quantitative analysis of drugs*. Japan: Chapman and Hall. vol. 3: pp. 456-458 (1964).
15. Dinis, T. C. P., Madeira, V. M. C., Almeida, L. M. (1994). Action of phenolic derivates (acetoaminophen, salicylate, and 5-aminosalicylate) as inhibitors of membrane lipid peroxidation and peroxy radicals scavengers. *Achieves of Biochemistry and Biophysics*, 315, 161-169.
16. Oyaizu, M. (1986). Studies on products of browning reactions: antioxidant activities of products of browning reaction prepared from glucose amine. *Japanese Journal of Nutrition*, 44, 307-315.
17. Adwas, A. A., Elsayed, A., Azab, A. E., & Quwaydir, F. A. (2019). Oxidative stress and antioxidant mechanisms in human body. *Journal of Applied Biotechnology & Bioengineering*, 6(1), 43-47.
18. Soare, J. R., Dinis, T. C., Cunha, A. P., & Almeida, L. (1997). Antioxidant activities of some extracts of *Thymus zygis*. *Free radical research*, 26(5), 469-478.
19. Garratt, D. C. (2012). *The quantitative analysis of drugs*. Springer Science & Business Media.
20. Marcocci, L., Maguire, J. J., Droylefaix, M. T., & Packer, L. (1994). The nitric oxide-scavenging properties of *Ginkgo biloba* extract EGb 761. *Biochemical and biophysical research communications*, 201(2), 748-755.
21. Ferreira Júnior, J.M.; de Vasconcelos Silva, M.G.; Monteiro, J.A.; de Sousa, Barros A.; Falcão, M.J.C.; de Morais, S.M.: Evaluation of antioxidant activity and inhibition of corrosion by Brazilian plant extracts and constituents. *Int. J. Electrochem. Sci.* 11, 3862-3875 (2016)
22. Zou Y., Y. Lu and D. Wei, *J. Agric. Food Chem.*, 2004, 52, no. 16, 5032-5039.
23. Prabakaran M., S.-H. Kim, V. Hemapriya and I.-M. Chung, *J. Ind. Eng. Chem.*, 2016.
24. Sheldon R.A., *Green chemistry and resource efficiency: towards a green economy*, *Green Chemistry*, 2016, 18, no. 11, 3180-3183.
25. Ferreira J.M. Jr., M.G. de Vasconcelos Silva, J.A. Monteiro, B.A. de Sousa, M.J.C. Falcão and de Morais, S.M., *Int. J. Electrochem. Sci.*, 2016, 11, 3862.
26. Gust J. and I. Wawer, *Corrosion*, 1995, 51, no. 1, 37.

27. Shanab, S.M.M. M.A. Ameer, A.M. Fekry, A.A. Ghoneim and E.A. Shalaby, *Int. J. Electrochem. Sci.*, 2011, 6, 3017.
28. Montoya, L.F. D. Contreras, A.F. Jaramillo, C. Carrasco, K. Fernándezd, B. Schwederskie, D. Rojasb and M.F. Melendrez, *Prog. Org. Coat.*, 2019, 127, 100– 109.
29. Gracenea, J.J. J.J. Saura and J.J. Suay, *Prog. Org. Coat.*, 2004, 50, no. 1, 68–74.
30. Mahmoudian, M.R. Y. Alias, W.J. Basirun and M. Ebadi, *Appl. Surf. Sci.*, 2013, 268, 302–311.
31. Sadighara,P. S. Gharibi, A.M. Jafari, G.J. Khaniki and S. Salari, *Avicenna J. Phytomed*, 2012, 2, 113.

## Caralluma Indica Stem, Phoenix Pusilla Leaves and Sansevieria Roxburghiana Leaves Extracts as Green Corrosion Inhibitors for Mild Steel in Acid Medium

A. Satish, S. Durgadevi and A. Leema Rose

PG and Research Department of Chemistry, Holy Cross College (Autonomous), (Affiliated to Bharathidasan University), Tiruchirappalli, Tamil Nadu, India

### ABSTRACT

Extract of natural plants is one of the most important metallic corrosion inhibitors. They are readily available, nontoxic, environmentally friendly, biodegradable, highly efficient, and renewable. The present study focuses on the corrosion inhibition effects of Caralluma indica stem, Phoenix pusilla and Sansevieria roxburghiana leaves extracts in 1M HCl solutions using weight loss techniques and followed by adsorption isotherms. The results obtained indicate that the extracts functioned as good corrosion inhibitors in 1M HCl solutions. The inhibition efficiency has been increase with increase in the concentration of extracts. The ethanol extract of Sansevieria roxburghiana leaves had the highest inhibitory efficiency among the plant followed by Phoenix pusilla leaves and Caralluma indica stem. The phytochemical constituents with functional groups in the plant extracts adsorbed on the metal surface are found responsible for the effective performance of the inhibitor. Data obtained from weight loss experiments and adsorption isotherms (Temkin and Freundlich) indicated that plant extract represent the corrosion of steel in acidic media and confirms to the adsorption mechanism. The result shows that the Caralluma indica stem, Phoenix pusilla and Sansevieria roxburghiana leaves extracts acts as corrosion inhibitor and is able to promote surface protection by blocking active sites on the metal.

Keywords: Anticorrosion, Hydrochloric acid, Caralluma indica stem, Phoenix pusilla leaves and Sansevieria roxburghiana leaves

### INTRODUCTION

Industries depend heavily on the use of metals and alloys. One of the most challenging and difficult tasks for industries are the protection of metals from corrosion. Corrosion is a ubiquitous problem that continues to be of great relevance in a wide range of industrial applications and products it results in the degradation and eventual failure of components and systems both in the processing and manufacturing industries and in the service life of many components. Corrosion control of metals and alloys is an expensive process and industries spend huge amounts to control this problem. It is estimated that the cost of corrosion in the developed countries such as the U.S. and European Union is about 3–5% of their gross national product [1,2,3]

Corrosion damage can be prevented by using various methods such as upgrading materials, blending of production fluids, process control and chemical inhibition [4,5]. Among these methods, the use of corrosion inhibitors [6,7] is the best to prevent destruction or degradation of metal surfaces in corrosive media. The use of corrosion inhibitors is the most economical and practical method in reducing corrosive attack on metals. Corrosion inhibitors are chemicals either synthetic or natural when added in small amounts to an environment, decrease the rate of attack by the environment on metals. A number of synthetic compounds [8,9,10,11] are known to be applicable as good corrosion inhibitors for metals. Nevertheless, the popularity and use of synthetic compounds as a corrosion inhibitor is diminishing due to the strict environmental regulations and toxic effects of synthetic compounds on human and animal life. Consequently, there exists the need to develop a new class of green corrosion inhibitors with low toxicity, eco-friendliness and good efficiency.

Throughout the ages, plants have been used by human beings for their basic needs such as production of food-stuffs, shelters, clothing, fertilizers, flavors and fragrances, medicines and last but not least, as corrosion inhibitors. The use of natural products as corrosion inhibitors can be traced back to the 1930's when plant extracts of *Chelidonium majus* (Celandine) and other plants were used for the first time in H<sub>2</sub>SO<sub>4</sub> pickling baths [12]. After then, interest in using natural products as corrosion inhibitors increased substantially and scientists around the world reported several plant extracts [13,14,15] and phytochemical leads [16] as promising green anticorrosive agents. Although, a number of plants and their phytochemical leads have been reported as anticorrosive agents, vast majority of plants have not yet been properly studied for their anti-corrosive activity

Recently, many eco-friendly corrosion inhibitors have been developed. For example, *Zygophyllum album* L. Leave [17], *Anacyclus pyrethrum* L. stem [18] and *Mentha Pulegium* leaf extract [19] were successfully reported for their anticorrosion properties. The observed results showed that all the above said plants have excellent anticorrosion effect and most importantly eco-friendly. In the present study, *Caralluma indica* stem,



*Phoenix pusilla* leaves and *Sansevieria roxburghiana* leaves extract was investigated for its effectiveness as a natural inhibitor to prevent corrosion of mild steel in 1M HCl using the weight loss method and Adsorption Isotherm followed by Langmuir and Temkin model.

## MATERIALS AND METHODS

### Collection and Preparation of alcoholic extract

The *Caralluma indica* stem, *Phoenix pusilla* leaves and *Sansevieria roxburghiana* leaves were collected from Sengipatti, Thanjavur, Tamil Nadu. The collected plant parts were shade dried and make a fine powder using a mixer grinder. 10grams of *Caralluma indica* stem, *Phoenix pusilla* leaves and *Sansevieria roxburghiana* leaves powder were used for extraction. Extraction was performed with cold extraction using the maceration method in ethanol solvent for 24 hours using the “intermittent shaking” method to obtain an extract. The extract was filtered using Whatman filter No 1 paper and filtrate was used for phytochemical analysis and anticorrosive activity.

### Qualitative Preliminary phytochemical analysis

Preliminary phytochemical test was carried out by using standard procedure [20,21,22,23].

## ANTICORROSIVE STUDY

### Effect of *Caralluma indica* stem, *Phoenix pusilla* leaves and *Sansevieria roxburghiana* leaves extract in different concentrations on mild steel

The mass loss studies were carried out at temperature 37°C in 100 ml of blank 1M HCl and test solutions of various concentrations of *Caralluma indica* stem, *Phoenix pusilla* leaves and *Sansevieria roxburghiana* leaves extract (5, 10, 30, 50, 70 and 100 ppm) for 72 hours. At the end of the reaction the specimens were taken out, washed with water, dried with air drier and weighed. Blank has taken as without sample. Corrosion rates (decrease in weight in gram per cm<sup>2</sup> per hour) were calculated using the following expression.

$$\text{Corrosion Rate (CR) (g.cm}^{-2}\text{ h}^{-1}) = \frac{W_1 - W_2}{A \times T}$$

Where,  $W_1$  = initial weight of rod,  $W_2$  = weight of rod after treatment,  $W_1 - W_2$  = weight loss (g),  $A$  = surface area,  $T$  = time in hours

The surface coverage ( $\Theta$ ) as a result of adsorption of inhibitor and inhibition efficiency (%) were calculated from corrosion rate values by using the following equation

$$\text{Surface coverage } (\Theta) = \frac{CR_B - CR_I}{CR_B}$$

$$\text{Inhibition efficiency } \% = \frac{CR_B - CR_I}{CR_B} \times 100$$

Where,  $CR_B$  = Corrosion Rate Blank and  $CR_I$  = Corrosion Rate Inhibitor.

### Adsorption Isotherm followed by Langmuir and Temkin model

The inhibition effect can be explained by adsorption of *Caralluma indica* stem, *Phoenix pusilla* leaves and *Sansevieria roxburghiana* leaves extract at the mild-steel surface. The *Caralluma indica* stem, *Phoenix pusilla* leaves and *Sansevieria roxburghiana* leaves extract replaces the water molecules at the metal interface according to the Langmuir and Temkin model [24,25].

### Atomic Absorption Spectroscopy (AAS)

The effect of inhibitor on mild steel specimen was observed using atomic absorption spectroscopy. *Caralluma indica* stem, *Phoenix pusilla* leaves and *Sansevieria roxburghiana* leaves extract was tested for its efficiency against 1 M HCl by incubating mild steel in the absence and presence of inhibitor (5, 10, 30, 50, 70 and 100 ppm) for 3 h at  $303 \pm 1.00$  K [26]. After immersion time, the corrodent solutions were observed for the concentration of dissolved ions in each solution to calculate the IE % using the following formula:

$$IE \% = B-A/B \times 100$$

where, A and B represents the amount of dissolved ions in the uninhibited and inhibited (with different concentration of inhibitor) corrodent solutions

## RESULTS AND DISCUSSION

### Preliminary Phytochemical Screening of the plant Extract

In this study to investigate the phytochemical analysis of alcoholic extracts from the stem of *Caralluma indica*, leaves of *Phoenix pusilla* and leaves of *Sansevieria roxburghiana*. The qualitative phytochemical analysis of the alcoholic extracts of *Caralluma indica* stem, *Phoenix pusilla* leaves and *Sansevieria roxburghiana* leaf shown that the presence of tannin, saponin, flavonoids, steroids, terpenoids, triterpenoids, alkaloids, anthroquinone, polyphenol and glycoside. **Weight Loss Method**

Among many experimental methods available to determine the percentage inhibition efficiency and corrosion rate, the weight loss method is the simplest and most frequently used. In this study, the experiments were carried out by varying the concentrations of the inhibitor. This study is also carried out at different temperatures and the immersion period is fixed at 72 h. The weight loss calculated, in grams, is the difference between the weight of metal coupon before and after immersion in a inhibitor solution. The corrosion rate of mild steel in 1M hydrochloric acid solution was studied by weight loss method in blank solution and with various concentration stem of *Caralluma indica*, leaves of *Phoenix pusilla* and leaves of *Sansevieria roxburghiana*.

### Effect of Concentration of Caralluma indica stem extract on corrosion inhibition

The inhibition efficiency and the corrosion rate values for all the studied inhibitors and the blank system were determined and given in Table 1. The corrosion rate decreases and the inhibition efficiency increases with the increase in the concentration of *Caralluma indica* stem extract for all inhibitors and the concentration range is 5 to 100ppm for 72 h immersion of the metal in inhibitor solution at room temperature (Figure 1 and 2). The inhibition efficiency increases because of the inhibitor molecules present in the *Caralluma indica* stem extract getting adsorbed on the metal surface. The maximum inhibition efficiency and the lower corrosion rate are found at high concentration (100ppm) for inhibitors (81.57%) while minimum inhibition efficiency at low concentration (5ppm) for inhibitors (23.68%).



Figure 1: Mass loss examination Caralluma indica stem extract

Table 1: Effect of Caralluma indica stem extract in corrosion rates, inhibition efficiency and surface coverage at various concentrations

Concentrations (ppm)	Weight loss (gm.cm <sup>-2</sup> )	Corrosion rate (g.cm <sup>-2</sup> /h) × 10 <sup>-4</sup>	Surface coverage (Θ)	Inhibition efficiency (%)
Control	1.14	3.29	-	-
5	0.87	2.51	0.23	23.68
10	0.64	1.85	0.43	43.85
30	0.48	1.38	0.57	57.89
50	0.38	1.09	0.66	66.66
70	0.26	0.75	0.77	77.19
100	0.21	0.60	0.81	81.57

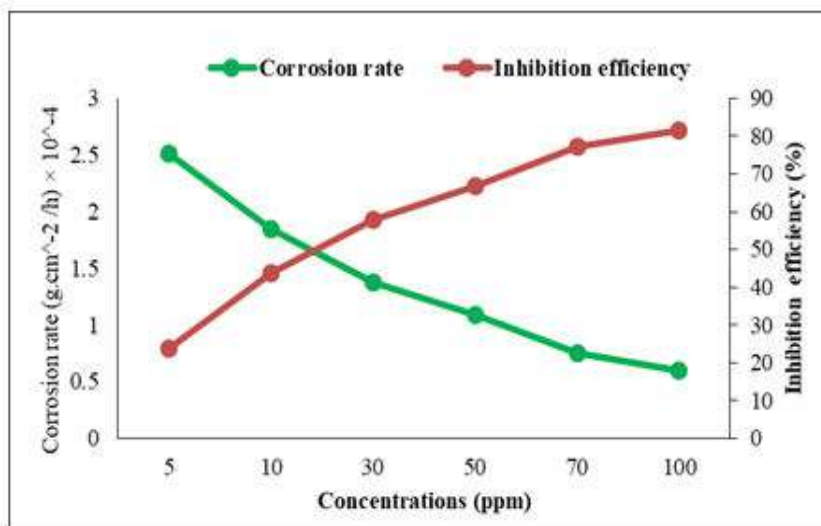


Figure 2: Effect of *Caralluma indica* stem extract in anti-corrosion activity

### Inhibition Adsorption Isotherm model

The inhibition effect can be explained by adsorption of *Caralluma indica* stem extract at the mild-steel surface. The *Caralluma indica* stem extract replaces the water molecules at the metal interface according to the Langmuir and Temkin model figure 3 and 4.

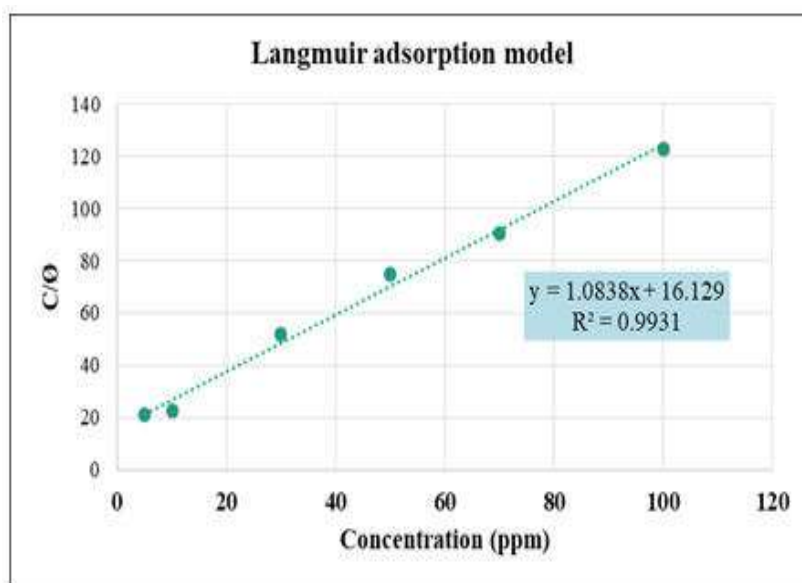


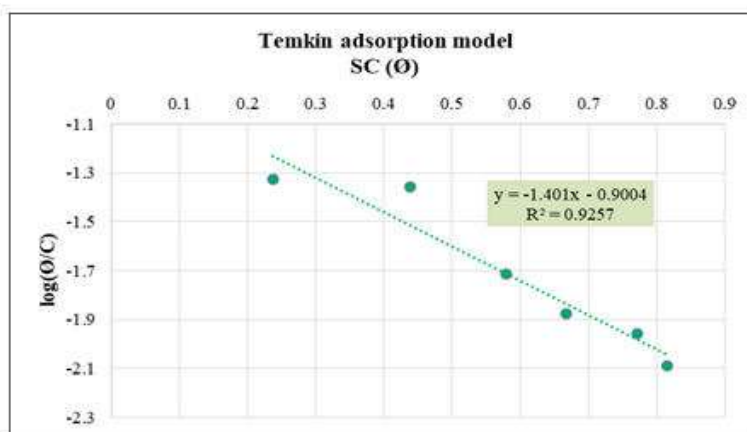
Figure 3: Langmuir Adsorption Isotherm plot for mild steel in 1M HCl with different inhibitory concentration of *Caralluma indica* stem extract

The Langmuir adsorption model was applied. Plotting the experimental data  $C/\theta$  versus  $C$  resulted in a fitted straight line as shown in Figure 3. Concentrations (ppm) is the inhibition concentration of *Caralluma indica* stem extract and  $\theta$  is the surface coverage. It is clear that the adsorption follows Langmuir adsorption isotherm, as indicated by the correlation coefficient ( $R$ ) = 0.996 and the slope = 1.083 as expected from Langmuir model followed by Ali and Mahrousb [27]

$$c/\theta = c + 1/K_{ads}$$

Thus, the adsorption of *Caralluma indica* stem extract as corrosion inhibitor was harmonious with Langmuir adsorption isotherm. The strength and stability of the adsorbed layer formed by *Caralluma indica* stem extract was evaluated from inverse of the plot intercept. The  $K_{ads}$  was found to be equal to  $0.062 \text{ ppm}^{-1}$ .

Temkin model was achieved by plotting  $\log(\theta/C)$  versus  $\theta$ , Figure 4. The obtained straight line has adjustable correlation coefficient  $R = 0.962$ . Thus, Temkin model is less acceptable than Langmuir model because of less  $R$  value [28].



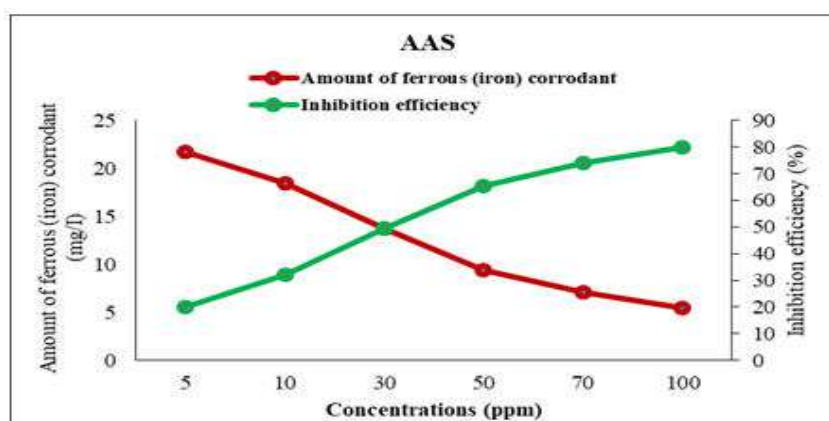
**Figure 4:** Temkin Adsorption Isotherm plot for mild steel in 1M HCl with different inhibitory concentration of *Caralluma indica* stem extract

### Atomic Absorption Spectroscopy

The analysis of dissolved ions in corrodent solution without inhibitor with that of corrodent solution with different concentrations of inhibitor (5, 10, 30, 50, 70, 70 and 100 ppm) were examined through AAS. The results (Table 2) were in correlation with mass loss measurement which exhibited corrosion inhibition in concentration dependent manner. Maximum level of inhibition against 1 M HCl corrosion was 79.83 % with 100 ppm at  $303 \pm 1.00$  K. A study on acid inhibitor preventing ferrous (iron) pigment corrosion. The inhibition efficiency of the plant extract based on concentration apparently happens by the adsorption of active constituents of *Caralluma indica* onto the surface of metal forming protective film thereby prohibiting oxidation and reducing the ferrous (iron) ion diffusion in the corrodent solution.

**Table 2:** AAS study of dissolved ferrous (iron) ions in corrodent solution against 1 M HCl control and different concentrations of *Caralluma indica* stem extract inhibitor

Concentrations (ppm)	Amount of ferrous (iron) corrodant (mg/l)	Inhibition efficiency (%)
Control	27.18	-
5	21.72	20.08
10	18.46	32.08
30	13.73	49.48
50	9.38	65.48
70	7.05	74.06
100	5.48	79.83



**Figure 5:** AAS study of dissolved ferrous (iron) ions in corrodent solution against 1 M HCl control and different concentrations of *Caralluma indica* stem extract inhibitor

The present study, the efficacy of *Caralluma indica* stem extract as an environmentally friendly inhibitor was demonstrated by investigating the mass loss behavior of mild steel in solutions of 1 M HCL. This indicates a high sensitivity of *Caralluma indica* stem extract toward inhibition of mild steel in acidic medium. It was also observed that adsorption follows Langmuir and Temkin isotherm model.

### Effect of Concentration of Phoenix pusilla leaves extract on corrosion inhibition

The inhibition efficiency and the corrosion rate values for all the studied inhibitors and the blank system are determined and given in Table 3 and figure 6. The corrosion rate decreases and the inhibition efficiency increases with the increase in the concentration of *Phoenix pusilla* leaves extract for all inhibitors and the concentration range is 5 to 100ppm for 72 h immersion of the metal in corrodent solution at room temperature. The inhibition efficiency increases because of the inhibitor molecules present in the *Phoenix pusilla* leaves extract getting adsorbed on the metal surface (Figure 6 and 7). The maximum inhibition efficiency and the lower corrosion rate are found at high concentration (100ppm) for inhibitors (85.96%) while minimum inhibition efficiency at low concentration (5ppm) for inhibitors (28.07%).



Figure 6: Mass loss examination Phoenix pusilla leaves extract

Table 3: Effect of Phoenix pusilla leaves extract in corrosion rates, inhibition efficiency and surface coverage at various concentrations

Concentrations (ppm)	Weight loss (gm.cm <sup>-2</sup> )	Corrosion rate (g.cm <sup>-2</sup> /h) × 10 <sup>-4</sup>	Surface coverage (Θ)	Inhibition efficiency (%)
Control	1.14	3.29	-	-
5	0.82	2.37	0.28	28.07
10	0.61	1.76	0.46	46.49
30	0.46	1.33	0.59	59.64
50	0.36	1.04	0.68	68.42
70	0.23	0.66	0.79	79.82
100	0.16	0.46	0.85	85.96

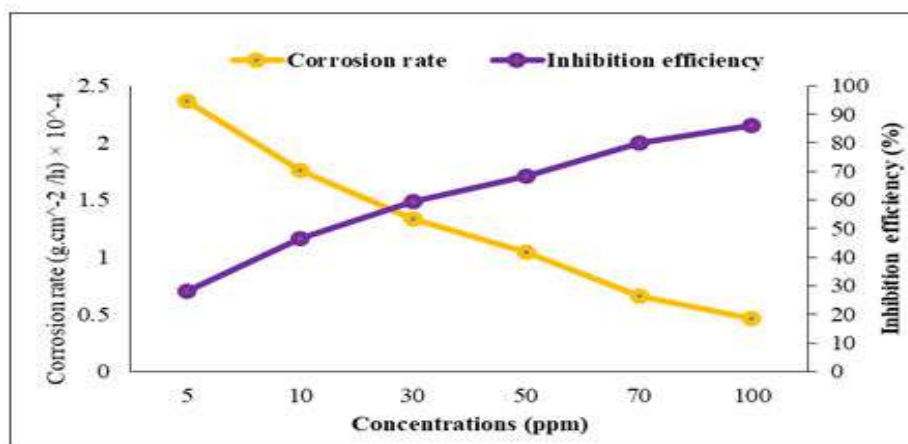
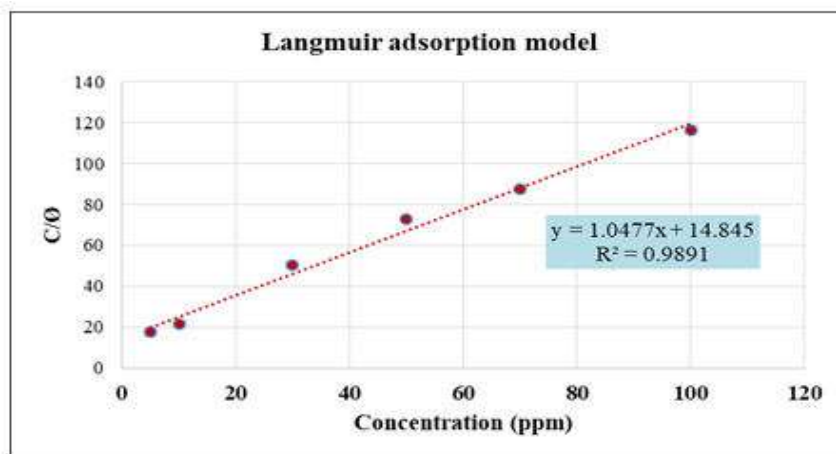


Figure 7: Effect of Phoenix pusilla leaves extract in anti-corrosion activity

### Inhibition Adsorption Isotherm model

The inhibition effect can be explained by adsorption of *Phoenix pusilla* leaves extract at the mild-steel surface. The *Phoenix pusilla* leaves extract replaces the water molecules at the metal interface according to Langmuir and Temkin model figure 8 and 9.



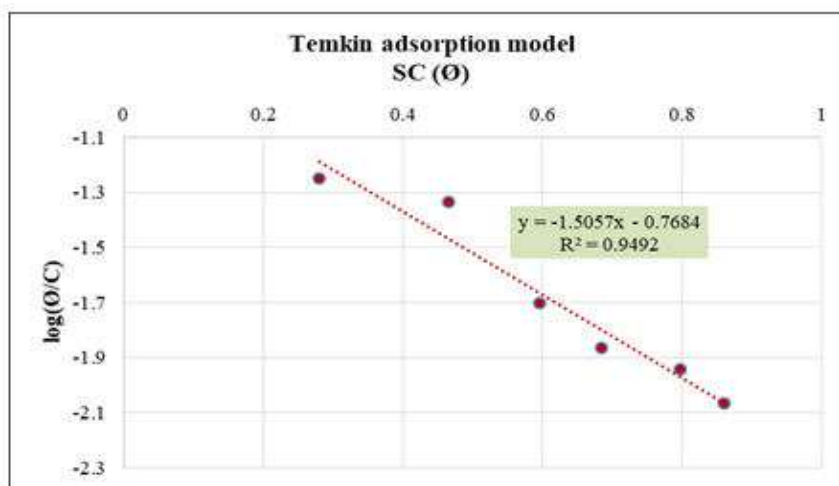
**Figure 8:** Langmuir Adsorption Isotherm plot for mild steel in 1M HCl with different inhibitory concentration of *Phoenix pusilla* leaves extract

The Langmuir adsorption model was applied. Plotting the experimental data  $C/\theta$  versus  $C$  resulted in a fitted straight line as shown in Figure 8. Concentrations (ppm) is the inhibition concentration of *Phoenix pusilla* leaves extract and  $\theta$  is the surface coverage. It is clear that the adsorption follows Langmuir adsorption isotherm, as indicated by the correlation coefficient ( $R$ ) = 0.994 and the slope = 1.047 as expected from Langmuir model followed by Ali and Mahrousb [27]

$$c/\theta = c+1/K_{ads}$$

Thus, the adsorption of *Phoenix pusilla* leaves extract as corrosion inhibitor was harmonious with Langmuir adsorption isotherm. The strength and stability of the adsorbed layer formed by *Phoenix pusilla* leaves extract was evaluated from inverse of the plot intercept. The  $K_{ads}$  was found to be equal to  $0.067 \text{ ppm}^{-1}$ .

Temkin model was achieved by plotting  $\log(\theta/C)$  versus  $\theta$ , Figure 9. The obtained straight line has adjustable correlation coefficient  $R = 0.974$ . Thus, Temkin model is less acceptable than Langmuir model because of less  $R$  value [28].



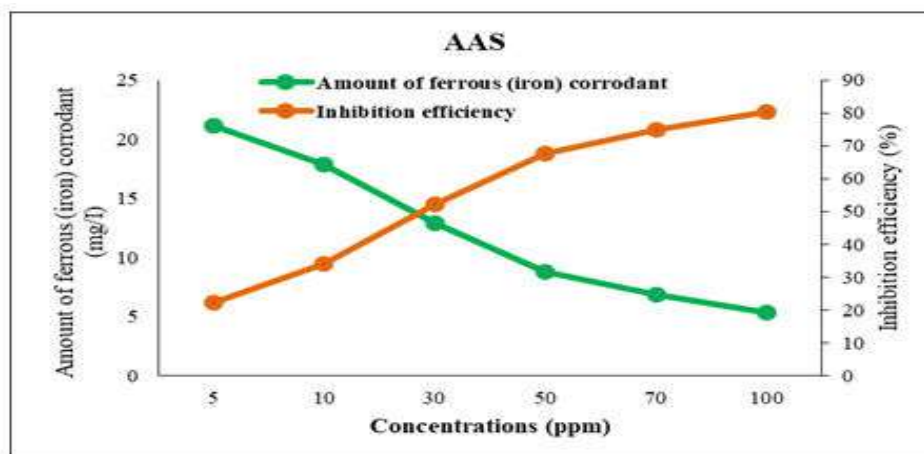
**Figure 9:** Temkin Adsorption Isotherm plot for mild steel in 1M HCl with different inhibitory concentration of *Phoenix pusilla* leaves extract

### Atomic Absorption Spectroscopy

The analysis of dissolved ions in corrodent solution without inhibitor with that of corrodent solution with different concentrations of inhibitor (5, 10, 30, 50, 70, 70 and 100 ppm) were examined through AAS. The results (Table 4) were in correlation with mass loss measurement which exhibited corrosion inhibition in concentration dependent manner. Maximum level of inhibition against 1 M HCl corrosion was 80.46 % with 100 ppm at  $303 \pm 1.00 \text{ K}$ . A study on acid inhibitor preventing ferrous (iron) pigment corrosion. The inhibition efficiency of the plant extract based on concentration apparently happens by the adsorption of active constituents of *Phoenix pusilla* leaves onto the surface of metal forming protective film thereby prohibiting oxidation and reducing the ferrous (iron) ion diffusion in the corrodent solution.

**Table 4:** AAS study of dissolved ferrous (iron) ions in corrodent solution against 1 M HCl control and different concentrations of Phoenix pusilla leaves extract inhibitor

Concentrations (ppm)	Amount of ferrous (iron) corrodant (mg/l)	Inhibition efficiency (%)
Control	27.18	-
5	21.14	22.22
10	17.91	34.10
30	12.95	52.35
50	8.75	67.80
70	6.85	74.79
100	5.31	80.46



**Figure 10:** AAS study of dissolved ferrous (iron) ions in corrodent solution against 1 M HCl control and different concentrations of Phoenix pusilla leaves extract inhibitor

The present study, the efficacy of *Phoenix pusilla* leaves extract as an environmentally friendly inhibitor was demonstrated by investigating the mass loss behavior of mild steel in solutions of 1 M HCL. This indicates a high sensitivity of *Phoenix pusilla* leaves extract toward inhibition of mild steel in acidic medium. It was also observed that adsorption follows Langmuir and Temkin isotherm model.

#### Effect of Concentration of *Sansevieria roxburghiana* leaves Extract on Corrosion Inhibition

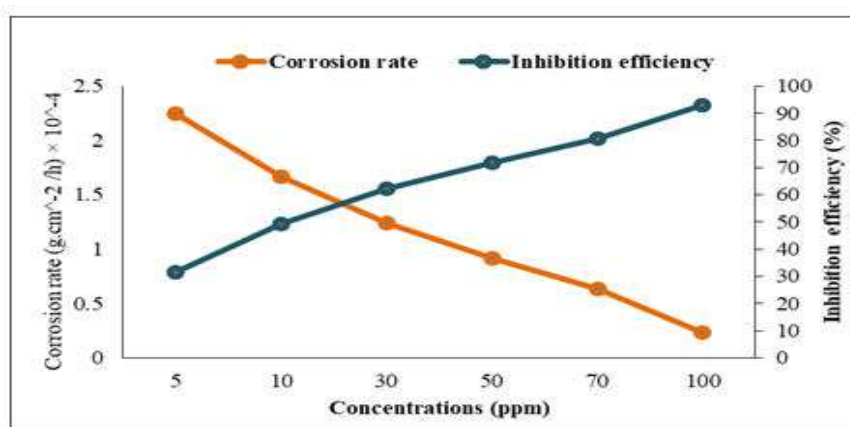
The inhibition efficiency and the corrosion rate values for all the studied inhibitors and the blank system are determined and given in Table 5. The corrosion rate decreases and the inhibition efficiency increases with the increase in the concentration of *Sansevieria roxburghiana* leaves extract for all inhibitors and the concentration range is 5 to 100ppm for 72 h immersion of the metal in corrodent solution at room temperature. The inhibition efficiency increases because of the inhibitor molecules present in the *Sansevieria roxburghiana* leaves extract getting adsorbed on the metal surface (Figure 11 and 12). The maximum inhibition efficiency and the lower corrosion rate are found at high concentration (100ppm) for inhibitors (92.98%) while minimum inhibition efficiency at low concentration (5ppm) for inhibitors (31.57%).



**Figure 11:** Mass loss examination *Sansevieria roxburghiana* leaves extract

**Table 5:** Effect of *Sansevieria roxburghiana* leaves extract in corrosion rates, inhibition efficiency and surface coverage at various concentrations

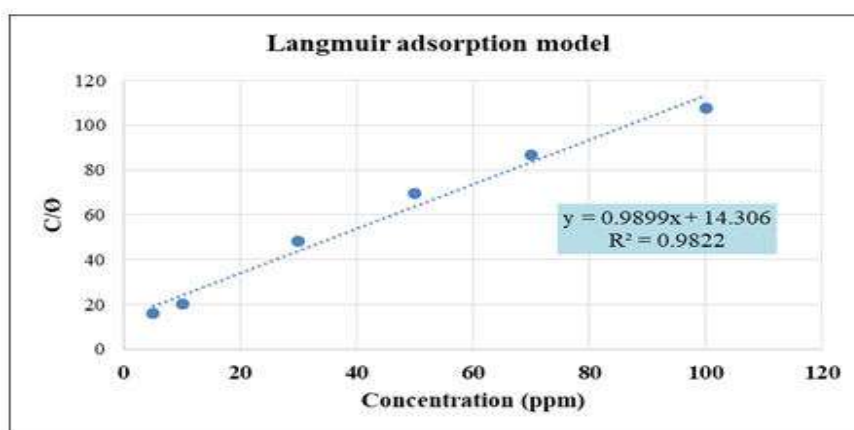
Concentrations (ppm)	Weight loss (gm.cm <sup>-2</sup> )	Corrosion rate (g.cm <sup>-2</sup> /h) × 10 <sup>-4</sup>	Surface coverage (Θ)	Inhibition efficiency (%)
Control	1.14	3.29	-	
5	0.78	2.25	0.31	31.57
10	0.58	1.67	0.49	49.12
30	0.43	1.24	0.62	62.28
50	0.32	0.92	0.71	71.92
70	0.22	0.63	0.80	80.70
100	0.08	0.23	0.92	92.98



**Figure 12:** Effect of *Sansevieria roxburghiana* leaves extract in anti-corrosion activity

#### Inhibition Adsorption Isotherm model

The inhibition effect can be explained by adsorption of *Sansevieria roxburghiana* leaves extract at the mild-steel surface. The *Sansevieria roxburghiana* leaves extract replaces the water molecules at the metal interface according to Langmuir and Temkin model figure 13 and 14.



**Figure 13:** Langmuir Adsorption Isotherm plot for mild steel in 1M HCl with different inhibitory concentration of *Sansevieria roxburghiana* leaves extract

The Langmuir adsorption model was applied. Plotting the experimental data  $C/\theta$  versus  $C$  resulted in a fitted straight line as shown in Figure 13. Concentrations (ppm) is the inhibition concentration of *Sansevieria roxburghiana* leaves extract and  $\theta$  is the surface coverage. It is clear that the adsorption follows Langmuir adsorption isotherm, as indicated by the correlation coefficient ( $R$ ) = 0.991 and the slope = 0.989 as expected from Langmuir model followed an equation by Ali and Mahrousb [27]

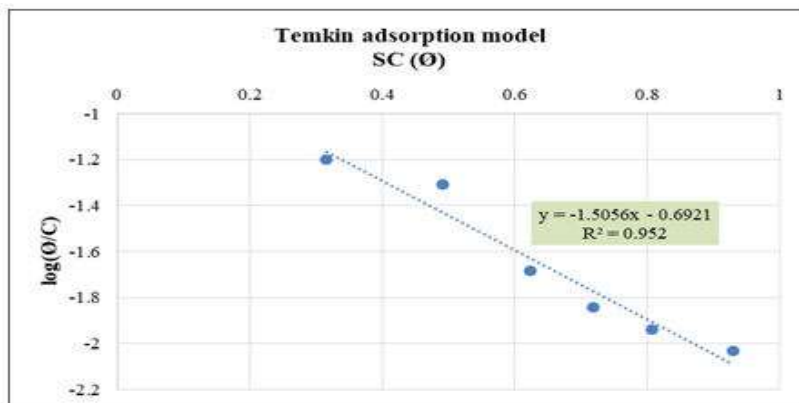
$$c/\theta = c+1/K_{ads}$$

Thus, the adsorption of *Sansevieria roxburghiana* leaves extract as corrosion inhibitor was harmonious with Langmuir adsorption isotherm. The strength and stability of the adsorbed layer formed by *Sansevieria*



*roxburghiana* leaves extract was evaluated from inverse of the plot intercept. The  $K_{ads}$  was found to be equal to  $0.069 \text{ ppm}^{-1}$ .

Temkin model was achieved by plotting  $\log(\theta/C)$  versus  $\theta$ , Figure 14. The obtained straight line has adjustable correlation coefficient  $R = 0.975$  Thus, Temkin model is less acceptable than Langmuir model because of less R value [28].



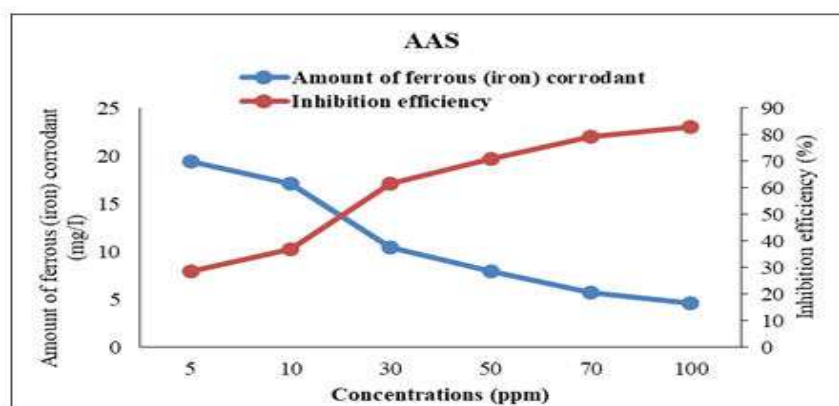
**Figure 14:** Temkin Adsorption Isotherm plot for mild steel in 1M HCl with different inhibitory concentration of *Sansevieria roxburghiana* leaves extract

#### Atomic Absorption Spectroscopy

The analysis of dissolved ions in corrodent solution without inhibitor with that of corrodent solution with different concentrations of inhibitor (5, 10, 30, 50, 70, 70 and 100 ppm) were examined through AAS. The results (Table 6) were in correlation with mass loss measurement which exhibited corrosion inhibition in concentration dependent manner. Maximum level of inhibition against 1M HCl corrosion was 82.96 % with 100 ppm at  $303 \pm 1.00 \text{ K}$ . A study on acid inhibitor preventing ferrous (iron) pigment corrosion. The inhibition efficiency of the plant extract based on concentration apparently happens by the adsorption of active constituents of *Sansevieria roxburghiana* leaves onto the surface of metal forming protective film thereby prohibiting oxidation and reducing the ferrous (iron) ion diffusion in the corrodent solution.

**Table 6:** AAS study of dissolved ferrous (iron) ions in corrodent solution against 1 M HCl control and different concentrations of *Sansevieria roxburghiana* leaves extract inhibitor

Concentrations (ppm)	Amount of ferrous (iron) corrodant (mg/l)	Inhibition efficiency (%)
Control	27.18	-
5	19.45	28.44
10	17.11	37.04
30	10.44	61.58
50	7.91	70.89
70	5.68	79.10
100	4.63	82.96



**Figure 15:** AAS study of dissolved ferrous (iron) ions in corrodent solution against 1 M HCl control and different concentrations of *Sansevieria roxburghiana* leaves extract inhibitor

The present study, the efficacy of *Sansevieria roxburghiana* leaves extract as an environmentally friendly inhibitor was demonstrated by investigating the mass loss behavior of mild steel in solutions of 1 M HCL. It was also observed that adsorption follows Langmuir and Temkin isotherm model.

### Corrosion Inhibition Mechanism

The adsorption of leaves extract is caused by the adsorption of phytochemical components contained in the leaf extract on the metal surface, which prevent the surface of the metal from the attack by acid and thus do not allow the corrosion action to occur [29]. The retardation of anodic dissolution in presence of an inhibitor molecule has been described by the mechanism involving two absorbed intermediate. It is a known fact that mild steel has coordination affinity to sulfur, nitrogen, and oxygen containing ligand [28]. The corrosion of mild steel in HCl solution containing plant extracts can be inhibited due to the adsorption of phytochemicals present in plant extracts through their lone pair of electrons and p-electrons with the d-orbitals on the mild steel surface [7,30,31].

The atoms such as N, O, and S are capable of forming coordinate covalent bond with metal owing to their free electron pairs and thus, act as inhibitor [32]. The process may block the active sites and hence decrease the corrosion rate. The aqueous leaf extract contains these atoms in their phyto-constituents and could be adsorbed on the surface of the metal and reduce the surface area available for a cathodic and anodic corrosion reaction to take place. In acidic solution, the active constituents present in the inhibitor exist as protonated species and adsorb on the cathodic sites of mild steel reducing the evolution of hydrogen. The adsorption on anodic sites occurs through  $\pi$  electrons and lone pair of electrons on hetero atom of the active components present in the inhibitor. For example, leaves extract of *Salvia officinalis* exhibited decent corrosion inhibition activity on 304 stainless steel in 1 M HCl solution because of the adsorption of phenolic components such as luteolin 7-glucuronide, carnosol, sagedomarin, etc., [33], through their heteroatoms including N and O, which acted as effective adsorption centers. *Osmanthus fragran* leaves extract has shown mixed type corrosion inhibition activity against carbon steel in 1 M HCl [34]. In another study, alkaloids extract of *Geissospermum* leaf has also demonstrated mixed type inhibition activity on C38 steel in 1 M HCl, which is revealed by Langmuir adsorption isotherm [35].

### CONCLUSION

The ethanol extracts of *Caralluma indica* stem, *Phoenix pusilla* leaves and *Sansevieria roxburghiana* leaves extracts have shown promising corrosion inhibition properties for mild steel in 1M HCl media. The inhibition efficiency was found to be directly proportional to the extract concentrations and followed the trend: *Sansevieria roxburghiana* leaves > *Phoenix pusilla* leaves > *Caralluma indica* stem. Adsorption of inhibitor on the surface of the mild steel obeyed both Langmuir and Temkin adsorption isotherms. Further investigations to assess the corrosion morphology and to isolate and confirm the active phytochemicals responsible for the inhibition of mild steel corrosion in acidic media are required.

### REFERENCES

1. Bhaskaran, R., Palaniswamy, N., Rengaswamy, N. S., & Jayachandran, M. (2005). A review of differing approaches used to estimate the cost of corrosion (and their relevance in the development of modern corrosion prevention and control strategies). *Anti-Corrosion Methods and Materials*, 52, 29.
2. Economic Effects of Metallic Corrosion in the United States, 1978a, NBS Special Publication 511-1, SD Stock No. SN-003-003-01926-7.
3. Economic Effects of Metallic Corrosion in the United States, 1978b, Appendix B, NBS Special Publication 511-2, SD Stock No. SN003-003-01927-5.
4. Ddkc, M., Yazici, B., & Erbil, M. (2004). The effect of indole on the corrosion behaviour of stainless steel. *Materials Chemistry and Physics*, 87(1), 138-141.
5. Galal, A., Atta, N. F., & Al-Hassan, M. H. S. (2005). Effect of some thiophene derivatives on the electrochemical behavior of AISI 316 austenitic stainless steel in acidic solutions containing chloride ions: I. Molecular structure and inhibition efficiency relationship. *Materials Chemistry and Physics*, 89(1), 38-48.
6. Raja, P. B., & Sethuraman, M. G. (2008). Natural products as corrosion inhibitor for metals in corrosive media—a review. *Materials letters*, 62(1), 113-116.
7. De Souza, F. S., & Spinelli, A. (2009). Caffeic acid is a green corrosion inhibitor for mild steel. *Corrosion science*, 51(3), 642-649.

8. Bentiss, F., Traisnel, M., Chaibi, N., Mernari, B., Vezin, H., & Lagrenée, M. (2002). 2, 5-Bis (n-methoxyphenyl)-1, 3, 4-oxadiazoles used as corrosion inhibitors in acidic media: correlation between inhibition efficiency and chemical structure. *Corrosion science*, 44(10), 2271-2289.
9. Abd El-Maksoud, S. A. (2004). The effect of hexadecyl pyridinium bromide and hexadecyl trimethyl ammonium bromide on the behaviour of iron and copper in acidic solutions. *Journal of Electroanalytical Chemistry*, 565(2), 321-328.
10. Kilmartin, P. A., Trier, L., & Wright, G. A. (2002). Corrosion inhibition of polyaniline and poly (o-methoxyaniline) on stainless steels. *Synthetic metals*, 131(1-3), 99-109.
11. Nishimura, R., & Maeda, Y. (2004). SCC evaluation of type 304 and 316 austenitic stainless steels in acidic chloride solutions using the slow strain rate technique. *Corrosion Science*, 46(3), 769-785.
12. Sanyal, B. (1981). Organic compounds as corrosion inhibitors in different environments—a review. *Progress in Organic Coatings*, 9(2), 165-236.
13. Benabdellah, M., Benkaddour, M., Hammouti, B., Bendahhou, M., & Aouniti, A. (2006). Inhibition of steel corrosion in 2 M H<sub>3</sub>PO<sub>4</sub> by artemisia oil. *Applied surface science*, 252(18), 6212-6217.
14. Raja, B. P., & Sethuraman, M. G. (2009). Strychnos nux-vomica an eco-friendly corrosion inhibitor for mild steel in 1 M sulfuric acid medium. *Materials and Corrosion*, 60(1), 22-28.
15. Buchweishaija, J., & Mhinzi, G. S. (2008). Natural products as a source of environmentally-friendly corrosion inhibitors: the case of gum exudate from *Acacia seyal* var, 26, 257.
16. Oguzie, E. E. (2007). Corrosion inhibition of aluminium in acidic and alkaline media by *Sansevieria trifasciata* extract. *Corrosion science*, 49(3), 1527-1539.
17. Derfouf H., H. Rouabhi, Y. Harek, L. Larabi., Inhibitive Action of Aqueous Extract of *Zygophyllum Album* L Leaves on the Corrosion of Carbon Steel in Hydrochloric Acid Solution. *Der Pharmacia Lettre*. 9: 57-68 (2017).
18. Selles C., B. Omar, T. Boufeldja, L. Larabi, Y. Harek., Green corrosion inhibitor: inhibitive action of aqueous extract of *Anacyclus pyrethrum* L. for the corrosion of mild steel in 0.5 M H<sub>2</sub>SO<sub>4</sub>. *J. Mater. Environ. Sci* : 206-219 (2012).
19. Khadraoui A., A. Khelifa, K. Hachama, H. Boutoumi, B. Hammouti., Synergistic effect of potassium iodide in controlling the corrosion of steel in acid medium by *Mentha pulegium* extract. *Research on Chemical Intermediates*. 41: 7973-7980 (2015).
20. Sofowara A (1993). *Medicinal plants and Traditional medicine in Africa*. Spectrum Books Ltd, Ibadan, Nigeria. p. 289.
21. Trease GE and Evans WC.(1989) *Pharmacognsy*. 11th edn. Brailliar Tiridel Can. Macmillian publishers.
22. Harborne JB. (1973) *Phytochemical Methods; A guide to modern techniques of plant Analysis*. 2nd Edition, London New York. pp. 49-188.
23. Harborne JB. (1984) *Phytochemical Methods. A Guide to Modern Technique of Plant analysis*. London: Chapman and Hall, pp.78-210.
24. Hosseini, M.; Mertens, S.F.L.; Arshadi, M.R. Synergism and antagonism in mild steel corrosion inhibition by sodium dodecylbenzenesulphonate and hexamethylenetetramine. *Corros. Sci.* 2003, 45, 1473–1489.
25. Rudresh, H.B.; Mayanna, S.M. Adsorption of n-Decylamine on Zinc from Acidic Chloride Solution. *J. Electrochem. Soc.* 1977, 124, 340.
26. Fadare O.O.; Okoronkwo A.E; Olasehinde E.F. Assessment of Anti-Corrosion Potentials of Extract of *Ficus asperifolia* –Miq (Moraceae) on Mild Steel in Acidic Medium. *Afr. J. Pure and Appl. Chem.*, 2016, 10, 8-22.
27. Ali, A.I.; Mahrousb, Y.S. Corrosion inhibition of C-steel in acidic media from fruiting bodies of *Melia azedarach* L extract and a synergistic Ni<sup>2+</sup> additive. *RSC Adv.* 2017, 7, 23687–23698.
28. Faiz, M.; Zahari, A.A.; Awanga, K.; Hussin, H. Corrosion inhibition on mild steel in 1 M HCl solution by *Cryptocarya nigra* extracts and three of its constituents (alkaloids). *RSC Adv.* 2020, 10, 6547–6562

29. Zakvi, S.; Mehta, G. Acid corrosion of mild steel and its inhibition by swertia augustifolia-study by electrochemical techniques. *Trans. SAEST* 1988, 23, 407–410.
30. Abdel-Gaber, A.M., AbdEL-Nabey, B.A., Saa dawy, M., 2009. *Corros. Sci.* 51, 1038.
31. Oguzie, E.E., 2008. *Corros. Sci.* 50, 2993.
32. Flick, E.W. *Corrosion Inhibitors: An Industrial Guide*; Noyes Publications: Park Ridge, NJ, USA, 1993.
33. Soltani, N.; Tavakkoli, N.; Khayatkashani, M.; Jalali, M.R.; Mosavizade, A. Green approach to corrosion inhibition of 304 stainless steel in hydrochloric acid solution by the extract of *Salvia officinalis* leaves. *Corros. Sci.* 2012, 62, 122–135.
34. Li, L.; Zhang, X.; Lei, J.; He, J.; Zhang, S.; Pan, F. Adsorption and corrosion inhibition of *Osmanthus fragran* leaves extract on carbon steel. *Corros. Sci.* 2012, 63, 82–90.
35. Faustin, M.; Maciuk, A.; Salvin, P.; Roos, C.; Lebrini, M. Corrosion inhibition of C38 steel by alkaloids extract of *Geissospermum laeve* in 1 M hydrochloric acid: Electrochemical and phytochemical studies. *Corros. Sci.* 2015, 92, 287–300.

## Corporate Attributes and Corporate Website Disclosure

Savita Sindhu

Goswami Ganesh Dutta Sanatan Dharma College, Chandigarh, India

### ABSTRACT

Corporate disclosure expectations have progressed beyond the ordinary making of compulsions. Companies who have articulated a complete approach to website disclosure with purpose and vision, supported by strategies, actions, measurable performances, and future course of actions, are winning the positive influence. But the disclosure differs from company to company, as every company has different attributes like size, profitability, leverage, nature of the industry, age, liquidity, and so on. Prior studies on website disclosures have discovered the association between the extent of website disclosure and factors affecting website disclosure. The purpose of this study is to investigate the nature and extent of the relationship between website disclosure and corporate attributes. The study highlighted the significant corporate attributes (company size, profitability, leverage, liquidity, and age) and expected signs of association with the extent of website disclosure.

Keywords: Corporate Website; Corporate Attributes; Website Disclosures; Size; Profitability.

### INTRODUCTION

“In this regard, prior research documents that the extent of Web-based disclosure is associated with firm size (Debreceny et al., 2002; Ettredge et al., 2002; Marston and Polei, 2004; Xiao et al., 2004; and Bollen et al., 2006), the level of information asymmetry between internal and external stakeholders (Ettredge et al., 2002), ownership characteristics (Marston and Polei, 2004), financial leverage (Xiao et al., 2004), the general disclosure environment (Bollen et al., 2006), industry membership (Brennan and Hourigan, 2000) and cross-listings (Debreceny et al., 2002; Marston and Polei, 2004; and Bollen et al., 2006)”.<sup>1</sup> “Abdelsalman et al. (2007) find corporate internet reporting comprehensiveness is related to analyst following, director holding, director independence, and CEO duality. Ismail (2002) finds that firm assets, profitability, and leverage affect the decision to disseminate financial information on the internet”.<sup>2</sup>

The determinants of website reporting were analysed by several studies in different countries such as New Zealand, Australia, Canada, Japan, Thailand, and Malaysia. Craven and Marston<sup>3</sup> analysed the disclosure of financial information on the internet. The sample consisted of 200 big companies in the UK in 1998. Company size and industry size were the two important independent variables. Using the chi-square test, results found a statistically significant positive relationship between the internet disclosure and the size of a company. Bonson and Escobar<sup>4</sup> examined the extent of financial information currently provided on the internet by the leading European companies. Study also identified the factors explaining the level of information disclosure of European companies. Data was collected from the biggest 20 companies in each European Union country in July and August 2001. The results showed a statistically significant relationship between the considered independent variables (sector, country of origin and size) and the extent of voluntary disclosure on the internet. Hamid and Salleh<sup>5</sup> examined the dissemination of Investor Relation (IR) information at corporate websites and the factors affecting the disclosure. The study included a sample of 100 Malaysian index-linked counters (CIs) listed on the Malaysia Stock Exchange. The relationship between four exploratory variables and investor relation disclosure was examined using Ordinary Least Squares (OLS) regression. Results found significantly positive association of website disclosure with company size and industry classification.

<sup>1</sup> Orens, R., Aerts, W. and Cormier, D. (2010), “Web-Based Non-Financial Disclosure and Cost of Finance”, *Journal of Business Finance & Accounting*, 1-37.

<sup>2</sup> Almilial, L.C. (2009), “Determining Factors of Internet Financial Reporting In Indonesia”, *Accounting and Taxation*, 1(1), 87-99.

<sup>3</sup> Craven, B.M. and Marston, C.L. (1999), “Financial Reporting on the Internet by Leading UK Companies”, *European Accounting Review*, 8:2, 321- 333.

<sup>4</sup> Bonson, E. and Escobar, T. (2002), “A Survey on Voluntary Disclosure on the Internet: Empirical Evidence from 300 European Union Companies”, *The International Journal of Digital Accounting Research*, 2(1), 27-51.

<sup>5</sup> Hamid, F.Z.A. and Salleh, S. (2005), “The Determinants of the Investor Relations Information in the Malaysian Companies’ Website”, *Corporate Ownership and Control*, 3(1), 173-185.

Abdelsalam and El-Marsy<sup>1</sup> investigated the timeliness of online reporting of 44 Irish companies with the ownership structure and board independence. Timeliness index found that only 46 per cent of companies satisfied the timeliness criteria. And after controlling firm performance, size and audit fees, results found positive association of board of director's independence and Chief Executive Officer Ownership with timeliness of online reporting. Akrouf and Othman<sup>2</sup> studied Arab Middle Eastern and North African companies environmental disclosure elements. Study investigated factors which are specific to this context: business culture, state ownership, family ownership and country's internet penetration. Sample of 153 websites of listed companies was used in the study. Results of the study found a negative and significant relationship between family ownership and environmental disclosure. Consistent with prior studies, results found that environment disclosure practices are associated with company performance and size.

**OBJECTIVES**

- To study the corporate attributes affecting the corporate website disclosure.
- To find out the expected signs of the association with the extent of corporate website disclosure.

**Corporate Attributes and Website Disclosure**

A wide variety of potential determinants of disclosure have been examined in the literature. A summary of major determinants of disclosure studies is presented in Table 1.1. This section presents a theoretical discussion of few significant corporate attributes affecting the disclosure practices of a company.

**Table 1.1:** Summary of Determinants of Corporate Website Reporting

Author(s)	Sample	Dependent Variable	Statistics	Independent Variables (* Significant Influence)
Davies and Kelly (1979)	Australia: 50 firms	Financial Reporting	Univariate	Size*
Firth (1979)	UK: 180 firms	Voluntary Financial Reporting	Univariate	Listing Status*, Auditor Size, Size*
Chow and Wong-Boren (1987)	Mexico: 52 firms	Voluntary Financial Reporting	Multivariate	Size*, Leverage
Cooke (1989)	Sweden: 90 firms	Financial Reporting	Multivariate	Industry*, Listing Status*, Size*
Cook (1991)	Japan :48 firms	Voluntary Financial Reporting	Multivariate	Industry*, Listing Status*, Size*
Lau (1992)	Hong Kong: 26 firms	Voluntary Financial Reporting	Multivariate	Leverage*, Profitability, Size
Malone et al. (1993)	USA: 125 firms	Financial Reporting	Multivariate	Leverage*, Auditor Size, Diversification, Listing Status*, Ownership Structure*, Foreign operations, Profitability, Proportion of outside directors, Size
Ahmed and Nicholls (1994)	Bangladesh: 60 firms	Mandatory Financial Reporting	Multivariate	Size, Leverage, Auditor Size*, Foreign parent*, Qualification of principal accounting officer*
Raffournier (1995)	Switzerland: 161 firms	Voluntary Financial Reporting	Univariate	Auditor Size*, Industry*, Leverage, Ownership Structure, Size, Internationality*, Profitability*
Inchausti (1997)	Spain: 138 firms	Financial Reporting	Multivariate	Auditor Size*, Profitability, Leverage, Size, Listing Status*
Marston and Robson (1997)	India: 58 firms	Financial Reporting	Univariate	Size*, Auditor Size

<sup>1</sup> Abdelsalam, O. and El-Masry, A. (2008), "The Impact of Board Independence and Ownership Structure on the Timeliness of Corporate Internet Reporting of Irish-Listed Companies", *Managerial Finance*, 34 (12), 907-918.

<sup>2</sup> Akrouf, M.M. and Othman, H.B. (2013), "A Study of the Determinants of Corporate Environmental Disclosure in MENA Emerging Markets", *Journal of Reviews on Global Economics*, 2, 46-59.

Owusu-Ansah (1998)	Zimbabwe: 49 firms	Mandatory Financial Reporting	Multivariate	Age*, Ownership Structure*, Auditor Size, Liquidity, Profitability*, Size*
--------------------	--------------------	-------------------------------	--------------	--

**Source:** Oyeler et al. (2003), "Determinants of Internet Financial Reporting by New Zealand Companies", *Journal of International Financial Management and Accounting*, 14(1)

### 1.1 SIZE OF A COMPANY

Size of a company is frequently considered as a significant factor of corporate internet disclosure. "Many researchers have found a positive relationship between firm's size and the extent of internet corporate disclosure (Pirchegger and Wagenhofer, 1999; Ashbaugh et al., 1999; Hedlin, 1999; Craven and Marston, 1999; Ettredge et al., 2001; Ettredge et al., 2002; Debreceny et al., 2002; Marston, 2003; Oyeler et al., 2003; Xiao et al., 2004; Lodhia et al., 2004; Marston and Polei, 2004)".<sup>1</sup> Several arguments have been put forward in the literature that considered size as a proxy for a number of company's characteristics. "Using agency theory, Hossain et al. (1995) explained the positive association between size and disclosure".<sup>2</sup> As compared to smaller companies, large companies have more means to produce information with lower cost. With better internal reporting system, large companies have more incentives to disclose voluntary information because they face higher political costs and pressures. With the fear of competitive disadvantage, smaller companies disclose lesser information. In the words of Aly and Simon (2008), "previous studies measured size in different ways and there is no theoretical reason behind the selection of a measure (Abd El Salam, 1999:42)". Singhvi and Desai (1971) and Buzby (1975) have measured size by total assets. Cooke in (1989)<sup>3</sup> used three size variables, total assets, number of shareholders and sales; and in (1992)<sup>4</sup>, considered eight size variables capital stock, turnover, total assets, current assets, number of shareholders, fixed assets, shareholders' funds and bank borrowings.

### 1.2 Profitability of a Company

"Signalling theory suggests that profitable companies have an incentive to disclose more information, to signal the firm's profitability to investors to support management continuation of their positions and compensation (Oyeler et al., 2003:36), and to raise capital at the lowest cost (Marston and Polei, 2004:294). Agency theory as well suggests that managers of higher profits companies have an incentive in disclosing more information to boost their compensation (Abd El Salam, 1999:46)".<sup>5</sup> Various studies on disclosure practices refer to profitability as an independent factor that may affect the disclosure level.

"Singhvi and Desai (1997) examined 500 large listed US firms, and found a positive association between profitability and the quality of disclosure" (Almilia and Surabaya, 2009)<sup>6</sup>. Aly and Simon (2008) stated that "Pirchegger and Wagenhofer (1999) found that profitability affects internet corporate disclosure of Austrian companies, but it does not affect that of German companies. Marston and Polei (2004:303) and Oyeler et al. (2003) found that profitability is not associated with internet reporting. Ismail (2002:18) found that profitability may increase the likelihood of the firm publishing financial information via the internet when this variable is within a particular range. If it increases beyond this range, the likelihood of firms publishing financial information on the internet decreases". Oyeler et al. (2003)<sup>7</sup> studied the elements of voluntary disclosure

<sup>1</sup> Aly, D. and Simon, J. (2008), "Assessing the Development of Voluntary Internet Financial Reporting and Disclosure in Egypt", available at: <http://www.baa.group.shef.ac.uk/events/conference/2008/papers/aly.pdf>, 1-60.

<sup>2</sup> Oyeler, P., Laswad, F. and Fisher, R. (2003), "Determinants of Internet Financial Reporting by New Zealand Companies", *Journal of International Financial Management and Accounting*, 14:1, 27-63.

<sup>3</sup> Cooke, T. E. (1989), "Disclosure in the Corporate Annual Reports of Swedish Companies", *Accounting and Business Research*, 19(74), 113-124.

<sup>4</sup> Cooke, T. E. (1992), "An Assessment of Voluntary Disclosure in the Annual Reports of Japanese Corporations", *The International Journal of Accounting*, 26, 174-189.

<sup>5</sup> Aly, D. and Simon, J. (2008), "Assessing the Development of Voluntary Internet Financial Reporting and Disclosure in Egypt", available at: <http://www.baa.group.shef.ac.uk/events/conference/2008/papers/aly.pdf>, 1-60.

<sup>6</sup> Almilia, L.S. and Surabaya, S.P. (2009), "Determining Factors of Internet Financial Reporting in Indonesia", *Accounting and Taxation*, 1(1), 87-99.

<sup>7</sup> Oyeler, P., Laswad, F. and Fisher, R. (2003), "Determinants of Internet Financial Reporting by New Zealand Companies", *Journal of International Financial Management and Accounting*, 14:1, 27-63.

practice by New Zealand companies. Findings reported that company liquidity, size, spread of shareholding and industrial sector has effect on website reporting as compared to the other characteristics. The results of the prior studies suggests that the company's profitability can be regarded as an indicator of good management, as management tends to disclose more information when profitability is high. Profitable companies have extra financial resources to disseminate financial information voluntarily or in compliance with additional regulations imposed. Alternatively these companies might have incentives to show stakeholders that they are more profitable than their competitors.

### **1.3 LEVERAGE OF A COMPANY**

Leverage of a company may also be related to disclosure practices on the websites. According to agency theory, "...highly leveraged firms have an incentive to voluntarily increase the level of corporate disclosure to stakeholders through traditional financial statement, and other media (Jensen and Meckling, 1976)".<sup>1</sup> However, research done over a period of time has shown mixed results. Aly and Simon (2008) stated the mixed results of prior studies, "Ettredge et al. (2002) and Ismail (2002) have found a relationship between a firm's leverage and the extent of internet corporate disclosure. On the other hand, Brennan and Hourigan (1998), Debreceeny et al. (2002), Oyeler et al. (2003), Xiao et al. (2004), and Debreceeny and Rahman (2004) did not find an association between leverage and internet corporate disclosure. Meek et al. (1995) and Zarzeski (1996) found that disclosure decreases with leverage; this may be because creditors are able to obtain private information. In contrast, Wallace et al. (1994) found no effect of leverage on disclosure. Ahmed and Courtis (1999:40,51), using meta-analysis, which involves combining the results of a set of disclosure studies over a period of time, concluded that disclosure increases with leverage".

Oyelere et al. (2003) study found that leverage does not explain the decision to use the internet as a medium for corporate financial reporting. Study explained that this may be due to the dissimilarities amongst internet financial reporting and traditional print-based financial reporting culture and environment, exhibited in the differences of costs, benefits, and demand and supply structures of the two environments. Zarzeski (1996)<sup>2</sup> advocated that companies having higher debt ratios share more information with their stakeholders because of good banking relationships. On the other hand, companies with lower debt ratio have a higher percentage of stock ownership, which would encourage investor demand for information.

### **1.4 LIQUIDITY OF A COMPANY**

The relationship between liquidity and the extent of disclosure have been examined by several studies, but they have contradictory outcomes. Wallace et al. (1994)<sup>3</sup> examined the multivariate impact of firm characteristics on disclosure in annual reports and accounts. Findings stated that companies with lower liquidity disclose more information and also highlighted that the disclosure of more information will increase the future expectations of stakeholders, therefore companies do not want to present extra information.

"Oyeler et al. (2003) found that liquidity is considered one of the primary determinants of internet financial reporting among New Zealand companies, and found a positive relationship between company liquidity and voluntary use of internet financial reporting. Other researchers (Owusu-Ansah, 1998; Abd El Salam, 1999; Wallace and Naser, 1995; Ahmed and Courtis, 1999) have found no association between liquidity and disclosure. Abd El Salam (1999:48) argued that companies, according to signalling theory, will disclose more if their liquidity ratio is high, to distinguish themselves from other companies. On the other hand, according to agency theory, companies with a low liquidity ratio may provide more information to satisfy the needs of shareholders and creditors" (Aly and Simon, 2008).

### **1.5 AGE OF A COMPANY**

It is generally argued that old companies disclose more information than the new companies. "The extent of a company's disclosure may be influenced by its age, i.e. stage of development and growth (Owusu-Ansah, 1998; Akhtaruddin, 2005). Owusu-Ansah (1998) pointed out three factors that may contribute to this phenomenon.

<sup>1</sup> Almilia, L.S. and Surabaya, S.P. (2009), "Determining Factors of Internet Financial Reporting in Indonesia", *Accounting and Taxation*, 1(1), 87-99.

<sup>2</sup> Zarzeski, M. T. (1996), "Spontaneous Harmonization Effects of Culture and Market Forces on Accounting Disclosure Practices", *Accounting Horizons*, 10(1), 18-37.

<sup>3</sup> Wallace, R. S. O., Nasser, K. and Mora, A. (1994), "The Relationship between the Comprehensive of Corporate Annual Reports and Firm Characteristics in Spain", *Accounting and Business Research*, 25(97), 41-53.



First, younger companies may suffer competition; second, the cost and the ease of gathering, processing and disseminating the required information may be a contributory factor, and finally, younger companies may lack a track record on which to rely for public disclosure”.<sup>1</sup>

Several previous studies have used company’s age variable. Results of prior studies are mixed, “...Hossain and Hammami (2009) found positive significant association between firm age and disclosure level, Alsaeed (2006) and Hossain and Reaz (2007) found no significant association”.<sup>2</sup>

Table 1.2 shows the companies’ attributes and the expected signs of the association with the extent of corporate website disclosure on the basis of prior literature.

**Table 1.2:** Corporate Attributes and Sign of Association with the Extent of Disclosure

Variables	Expected Sign	Proxies
Size	+	Shareholders’ Funds
Profitability	+/-	Return on Assets (Profit after tax/Total Assets)
Leverage	+	Debt to Equity Ratio (Total Debt/ Shareholder Equity)
Liquidity	+/-	Current Ratio (Current Assets/ Current Liabilities)
Age	+/-	Number of years since the date of incorporation of a company

To promote confidence and encourage investors to invest, companies should meet stakeholders’ demands for greater speed and volume of transparent and timely information. The internet can provide better and more effective ways of communicating corporate information. Therefore, there is a need to examine the role played by the internet in communicating corporate information in order to find out how that role may be enhanced.

## CONCLUSION

The study presented a deeper understanding of the corporate website disclosure in relation to corporate attributes by collecting the findings of the prior different studies. In this context, study highlighted the significant corporate attributes (company size, profitability, leverage, liquidity and age) and expected sign of association with the extent of website disclosure.

## REFERENCES

1. Abdelsalam, O. and El-Masry, A. (2008), “The Impact of Board Independence and Ownership Structure on the Timeliness of Corporate Internet Reporting of Irish-Listed Companies”, *Managerial Finance*, 34(12), 907-918.
2. Akrouf, M.M. and Othman, H.B. (2013), “A Study of the Determinants of Corporate Environmental Disclosure in MENA Emerging Markets”, *Journal of Reviews on Global Economics*, 2, 46-59.
3. Almilia, L.C. (2009), “Determining Factors of Internet Financial Reporting In Indonesia”, *Accounting and Taxation*, 1(1), 87-99.
4. Almilia, L.S. and Surabaya, S.P. (2009), “Determining Factors of Internet Financial Reporting in Indonesia”, *Accounting and Taxation*, 1(1), 87-99.
5. Aly, D. and Simon, J. (2008), “Assessing the Development of Voluntary Internet Financial Reporting and Disclosure in Egypt”, available at: <http://www.baa.group.shef.ac.uk/events/conference/2008/papers/aly.pdf>, 1-60.
6. Bonson, E. and Escobar, T. (2002), “A Survey on Voluntary Disclosure on the Internet: Empirical Evidence from 300 European Union Companies”, *The International Journal of Digital Accounting Research*, 2(1), 27-51.

<sup>1</sup> Mohammed, S. and Islam, M. (2014), “Nonfinancial Information Disclosure and Company Characteristics: A Study on Listed Pharmaceutical and Chemical Companies of Bangladesh”, *Pacific Business Review International*, 6 (8), 16-24.

<sup>2</sup> Uyar, A., Kilic, M. and Bayyurt, N. (2013), “Association between Firm Characteristics and Corporate Voluntary Disclosure: Evidence from Turkish Listed Companies”, *Intangible Capital*, 9 (4), 1068-1112.

7. Cooke, T. E. (1989), "Disclosure in the Corporate Annual Reports of Swedish Companies", *Accounting and Business Research*, 19(74), 113-124.
8. Cooke, T. E. (1992), "An Assessment of Voluntary Disclosure in the Annual Reports of Japanese Corporations", *The International Journal of Accounting*, 26, 174-189.
9. Craven, B.M. and Marston, C.L. (1999), "Financial Reporting on the Internet by Leading UK Companies", *European Accounting Review*, 8:2, 321- 333.
10. Hamid, F.Z.A. and Salleh, S. (2005), "The Determinants of the Investor Relations Information in the Malaysian Companies' Website", *Corporate Ownership and Control*, 3(1), 173-185.
11. Mohammed, S. and Islam, M. (2014), "Nonfinancial Information Disclosure and Company Characteristics: A Study on Listed Pharmaceutical and Chemical Companies of Bangladesh", *Pacific Business Review International*, 6 (8), 16-24.
12. Orens, R., Aerts, W. and Cormier, D. (2010), "Web-Based Non-Financial Disclosure and Cost of Finance", *Journal of Business Finance & Accounting*, 1-37.
13. Oyelere, P., Laswad, F. and Fisher, R. (2003), "Determinants of Internet Financial Reporting by New Zealand Companies", *Journal of International Financial Management and Accounting*, 14:1, 27-63.
14. Sindhu, S. (2021), "Corporate Environmental Disclosure", *Shodh Sarita- An International Bilingual Peer Reviewed Refereed Research Journal*, 8(29), 79-84.
15. Uyar, A., Kilic, M. and Bayyurt, N. (2013), "Association between Firm Characteristics and Corporate Voluntary Disclosure: Evidence from Turkish Listed Companies", *Intangible Capital*, 9(4), 1068-1112.
16. Wallace, R. S. O., Nasser, K. and Mora, A. (1994), "The Relationship between the Comprehensive of Corporate Annual Reports and Firm Characteristics in Spain", *Accounting and Business Research*, 25(97), 41-53.
17. Zarzeski, M. T. (1996), "Spontaneous Harmonization Effects of Culture and Market Forces on Accounting Disclosure Practices", *Accounting Horizons*, 10 (1), 18-37.

## A Case Series on Clinical Efficacy of Siddha Management in Covid-19

Chithra M<sup>1</sup>, Arivol R<sup>2</sup> and Sundari K<sup>3</sup>

<sup>1</sup>National Institute of Siddha, Tambaram, Sanatorium, Chennai-600047, India

<sup>2</sup>Private Siddha Medical Practitioners, Kandigai, Chennai – 600127, India

<sup>3</sup>Private Siddha Medical Practitioners, Maraimalainagar, Chennai -603209, India

### ABSTRACT

The outbreak of coronavirus disease (COVID-19) started at Wuhan, China during the year 2019. Despite the discovery of vaccinations multiple countries including India are now still experiencing the next waves of the COVID-19 with new variants. This in turn poses a huge burden on humanity due to economic crisis and causing a lot of Post covid complications. Hence it is anticipated that Siddha herbo mineral formulations along with external therapeutic measures would have great effect in the early course of the disease in reducing the disease burden. The present study is an experiential sharing of the author's clinical experience in the management of subjects with covid-19 who were under home quarantine with Siddha herbomineral formulations and external therapeutic measures. All the cases showed good prognosis with shorter treatment period and improved clinically with Siddha treatment. Hence these medicines can be used as add on therapy to mild to moderate stages of Covid -19 in the prevention of the disease progression to severe stage

Keywords: Coronavirus disease, Siddha, Traditional medicine, Kabasura Kudineer, Herbal medicine

### INTRODUCTION

Since time immemorial, herbal medicines were used by the Egyptians, Greek, Chinese and Indians for various human ailments. This traditional knowledge has been time-tested transferred from generation to generation and 80% of the world's population still depend mainly on traditional medicines for their health care.(1) The present Corona virus disease known as 2019-nCoV, has gained worldwide attention as the World Health Organization (WHO) officially declared the COVID19 epidemics as a public health emergency of international concern on 30 January 2020.(2) Siddha system stands on its fundamental concept of tri humours (*Vatham, Pitham and Kabam*). The selected Siddha medicines such as *Kabasura kudineer, Thalishathy Chooranam, Swasa kudori Tablets, Adathodai Manapaagu and vasantha kusumakaram tablets* have been used routinely for common respiratory illness by Siddha practitioners since age old times with safety and efficacy as per its indications in authoritative Siddha texts. In this present study, these formulations have been repurposed to neutralize the exaggerated *Kaba kutram* and its associated symptoms of Covid-19.

### MATERIALS AND METHODS

The present study is an experiential report on Siddha intervention for seven SARS-CoV-2 positive cases aged 35 - 44 years. One among them 44-year male was a hypertensive patient. All cases were found to be RT-PCR Positive for SARS CoV-2 antigen. They were presented with mild to moderate Covid symptoms (Fever, Head ache, Body pain, Cough and loss of taste). All these cases voluntarily requested for Siddha treatment and were treated under home quarantine. They also took allopathy medications paracetamol(sos) and multivitamins during the treatment period .

Table-1. Siddha therapeutic regimen

Procedure	Therapeutics	Dosages
1. Kashaayam	Kabasura kudineer	Twice a day 60 ml bd for 5 days
2. Chooranam	Thalishathy Chooranam	5 gm bd with honey
3. Tablet	Swasa kudori	2 pills twice a day
4. Manapaagu	Adathodai	10ml twice a day
5. Tablet	Vasantha kusumakaram	2 pills twice a day

Besides the above internal medicines, the external therapeutic measures such as salt water gargling was done twice a day, Pranayama (Breathing exercise) once a day, Sun bath 10 minutes/Day, Herbal steam inhalation twice a a day, Herbal pouch Oma pottanam for nasal inhalation was done frequently. The effect of Siddha treatment was assessed before and after treatment was assessed

RESULTS AND DISCUSSION

Figure-1. Effect of Siddha treatment on Temperature (Day-1 to Day-5)

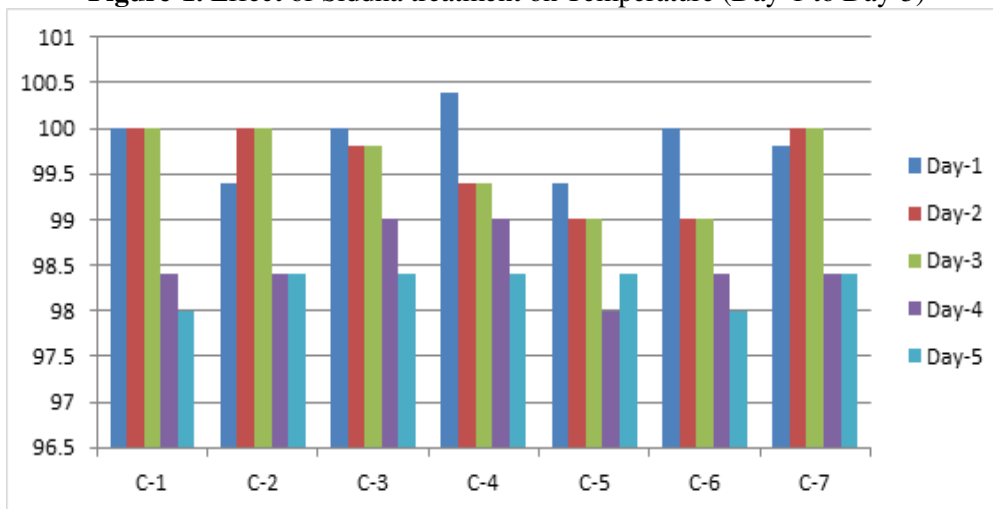


Figure-2. Effect of Siddha treatment on Oxygen saturation (Day-1 to Day-5)

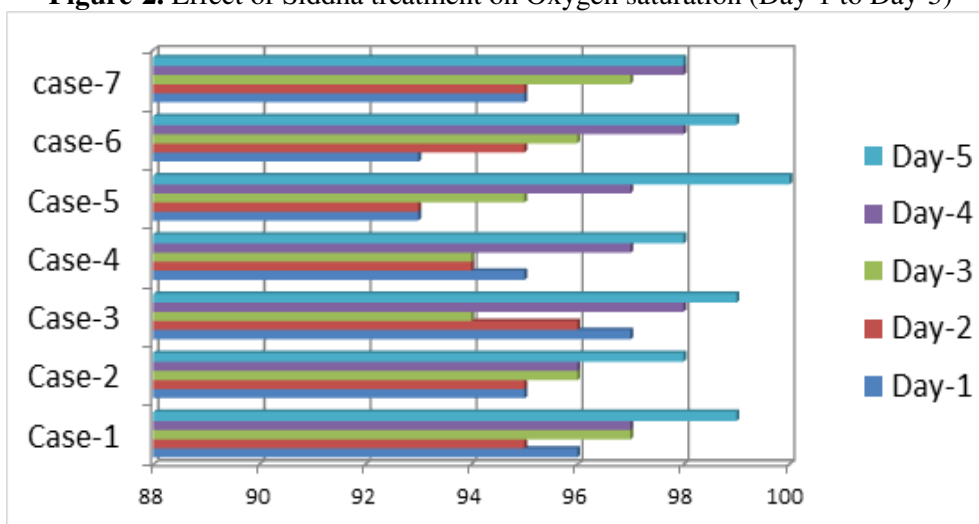


Table-1. Effect of Siddha treatment on blood pressure (Day-1 to Day-5)

CASES	Day-1	Day-2	Day-3	Day-4	Day-5
C-1	130/80	120/80	120/80	130/80	120/80
C-2	130/70	130/70	120/80	120/70	120/70
C-3	130/90	130/80	120/70	120/90	120/80
C-4	110/70	110/70	120/80	110/70	130/70
C-5	110/70	110/70	120/80	120/70	110/80
C-6	130/90	130/80	120/80	130/80	130/80
C-7	140/90	140/80	140/90	140/80	140/80

Table-2. Effect of siddha treatment on ESR, D-Dimer,CRP (After 15 days)

Cases	Platelet count lakhs/cumm		ESR mm/hr		D-dimer FEU		CRP mg/L	
	BT	AT	BT	AT	BT	AT	BT	AT
1	2.1	4.2	34	16	0.52	0.32	0.73	0.3
2	1.8	3.5	30	18	0.5	0.3	0.7	0.3
3	3.2	4.7	28	14	0.54	0.28	0.8	0.21
4	3.4	5.2	35	18	0.56	0.3	0.67	0.4
5	2.8	3.7	32	20	0.53	0.34	0.79	0.2
6	3.8	4.2	30	15	0.53	0.3	0.76	0.31
7	3.7	4.5	36	16	0.5	0.26	0.71	0.27

According to Siddha doctrine, the prime principle is, "Food is medicine and medicine is food." Hence the six taste and three humoral theory is the operating force behind the choice of food as well as medicine. (3)

The Siddha system categorizes all kinds of respiratory illness associated with production of phlegm as Kaba noigal or Iyya Noigal and prescribes a vast number of herbal and herbomineral formulations in its literature. *Kapha* humor is a combination of two elements water and earth. Most of the herbs used in Siddha preparations for *Kapha* diseases are of bitter and acrid/pungent taste. Bitter reduces all glandular secretions, salivation, and excess body heat. It will improve renal and bowel functions. It will remove toxins from our body. The pungent taste will remove phlegm from the lungs. When taken in the correct quantity, it reduces the inflammatory diseases of the throat (4) Moreover, this system of medicine also emphasise the adherence of rules for healthy living such as yoga, pranayama, steam bath, sun bath and other external therapeutic measures like inhalation of herbal pouches. The study also adopted these therapeutical measure for the patients and this produced synergistic effects. The herbal and herbomineral drugs selected by the author in the management of the present case series are from the books listed in the Drugs and Cosmetics Act. The phytochemical constituents present in Kabasura Kudineer the most widely used chief Siddha formulation for Covid has been studied for its anti-inflammatory, antipyretic, analgesic, anti-viral, antibacterial, anti-fungal, anti-oxidant, hepato-protective, antidiabetic, anti-asthmatic, anti-tussive, immunomodulatory, antidiarrhoeal and anti-oxidant activities.(5) Figure-1 shows considerable reduction in body temperature from day-1 to day-5. The antipyretic action of Flavonoids are an important group of polyphenols of Kabasura Kudineer. It is due to the inhibition of prostaglandin synthesis which are known mediators of inflammation. anti-oxidant activity, promising anti-inflammatory, antipyretic and antibacterial activity.(1)

Oxygen saturation is an essential element of patient care. Oxygen is tightly regulated within the body because hypoxemia can lead to many acute adverse effects on individual organ including the brain, heart, and kidneys.(6) The present Siddha therapeutic regimen used in this study improved the oxygen saturation rate as shown in Figure-2. Case 5 and Case 6 showed lowest oxygen saturation of 93% in day one which improved significantly to 99 on day 5. A case report of previous outcomes of Ayurvedic intervention in a COVID-19 patient with severe breathing difficulty also confirmed that the patient recovered with only supportive Ayurvedic care . Moreover, *in silico* studies have indicated that many herbs used in traditional medicines could have the ability to prevent cell entry of the SARS-CoV-2 virus .(7)

In a recent open label two arm - randomized controlled interventional clinical study, Group I patients were assigned to Siddha add on treatment Kabasura kudineer, Vasantha kusumakaram Mathirai, Thippili Rasayanam, Adathodai Manapagu, added with the standard treatment for a duration of about 14 days whereas Group II subjects were assigned with standard treatment alone. The patients recruited for the study were Covid 19 RT-PCR +ve patients declared by Tamil Nadu Government and admitted in IPD (in patient ward) at Omandurar Government Medical College Hospital. The study concludes that Siddha add on Group showed accelerated recovery for Covid - 19 patients compared to standard treatment Group. The synergistic effect of Siddha add on with standard treatment gave more promising results during the entire study period of Covid – 19.(9)

Another study confirms that all the patients taking Nilavembu Kudineer and Kaba Sura Kudineer showed early recovery signs and were discharged by day 6. Further, the patients in the KSK arm recovered even faster than the NVK arm as 60% of patients of the KSK arm were discharged on day 3.(10)

Another study on *Siddha Herbal Preparation – M V Kashayam* showed that the herbal drug was 87.5% effective in patients with co-morbid conditions like diabetes and hypertension. The patients recovered within the period of 4–6 days with RT-PCR negative without any supplements and side effects and it proved by clinical findings. Similarly, this drug is effective at any stage of severity in the clinical condition of the patients from strongly positive to mild positive condition.(11)

The external therapeutic measures like sun bath, Inhalation with *Notchi* leaves were employed on humoral basis as the hot potencies of these therapies increases and normalizes *Pitham* and expels out excessive *Kabam* (Phlegm) which is the root cause of Kaba suram. Also, the Siddha treatment regime had good prognostic effects on Blood pressure and blood parameters such as ESR, D-DIMER and CRP as shown in table 1 and Table-2. All the cases were relieved of symptoms of fever, head ache, body pain within 5 days of treatment. symptoms of Cough, and Loss of taste were gradually reduced and normalized within 10 days. The treatment was continued for 15 days so as to prevent any post covid complications. There was no observed side effects and Post covid complications in all the seven cases.

The medicines selected as Siddha regimen by the author had been already given for fever and respiratory ailments for decades by Siddha practitioners. Hence, repurposing these existing drugs could help to reduce the disease burden in this pandemic situation.

### CONCLUSION

The clinical results of our study showed that the patients had better promising results and the treatment appears to help them recover well without any requirement for hospitalization. Though these medicines are time-tested with low scientific evidence and unknown target site of their actions, the trihumoural basis of these formulations deserve attention. Through this case series, an integrative setup including Siddha care may be considered as first-line cost-effective treatment for mild to moderate COVID-19 to hamper the disease progression to severe hypoxic stage and also for the prevention of post covid complications.

### REFERENCES

1. Saravanan J, Kasiramar G, Sanish V, Kokila M. Anti-inflammatory, antipyretic and antibacterial study of Kabasura kudineer choornam. *Int J Curr Adv Res.* 2018 Feb 14;7:9992–7.
2. Cucinotta D, Vanelli M. WHO Declares COVID-19 a Pandemic. *Acta Bio-Medica Atenei Parm.* 2020 Mar 19;91(1):157–60.
3. R.Anaivarai Anandhan (Ed.), Principles of diagnosis in Siddha -Part 1(first ed.), Department of Indian medicine and Homeopathy, Chennai (2009).
4. T.K. BhavishyaHaniya et al Role of tastes in treatment modalities of siddha science Siddha papers, 1 (2016), pp. 1-10.
5. Vanan T, K S. Inhibitory effect of siddha herbs on rna types of virus -a review. *Indian J Appl Res.* 2020 Jun 2;
6. Hafen BB, Sharma S. Oxygen Saturation. In: StatPearls [Internet]. Treasure Island (FL): StatPearls Publishing; 2022 [cited 2022 Mar 22]. Available from: <http://www.ncbi.nlm.nih.gov/books/NBK525974/>
7. Girija PLT, Sivan N. Ayurvedic treatment of COVID-19/SARS-CoV-2: A case report. *J Ayurveda Integr Med.* 2020 Jun 19;13(1):100329.
8. Joshi JA, Puthiyedath R. Outcomes of Ayurvedic care in a COVID-19 patient with hypoxia – A case report. *J Ayurveda Integr Med.* 2022 Jan 1;13(1):100363.
9. Chitra M, Mallika P, Anbu N, Narayanababu R, Sugunabai R, Paul Raj D, et al. Journal Pre-proof An Open Clinical Evaluation of Selected Siddha Regimen In Expediting The Management Of Covid-19 -A Randomized Controlled Study an open clinical evaluation of selected siddha regimen in expediting the management of covid-19 -a randomized controlled study. *J Ayurveda Integr Med.* 2021 Jan 22;13.
10. Srivastava A, Rengaraju M, Srivastava S, Narayanan V, Gupta V, Upadhyay R, et al. Efficacy of two siddha polyherbal decoctions, Nilavembu Kudineer and Kaba Sura Kudineer, along with standard allopathy treatment in the management of mild to moderate symptomatic COVID-19 patients—a double-blind, placebo-controlled, clinical trial. *Trials.* 2021 Aug 28;22:570.
11. Sp, Malarkannan & P, Dharumarajan & Mk, Hariyohesh. (2021). A Clinical Study Of Siddha Herbal Preparation – M V Kashayam For The Treatment, Control, And Management Of Covid-19. *Asian Journal of Pharmaceutical and Clinical Research.* 104-107. 10.22159/ajpcr.2021.v14i6.41582.]Interdisciplinary perspectives on infectious diseases. 2015. 346853. 10.1155/2015/346853.

## **Impact of Talent Acquisition Practices on Service Sector in Mumbai**

**Ritika H. Pathak**

Department of BAF BBI BFM BMS, Kishinchand Chellaram College, (Commerce), India

### **ABSTRACT**

The objective of this paper is to understand the concept of talent acquisition as a component of Talent management. This paper focuses on five sectors, viz., Tourism Sector, Education Sector, Insurance Sector, Banking Sector and Health Sector, which form the core of the present research study. The paper focuses on understanding the impact of how talent acquisition practices in the service sector in Mumbai. For the study, a survey was conducted to get information about the practices by the HR department and employees of various service sector organization. Suggestions for improving the talent acquisition strategies were made.

### **I. INTRODUCTION**

In the present scenario, business organizations are realizing that it is only their people and their abilities to form diverse, versatile and flexible teams that can help the organization to succeed in the long run. Talent management is a comprehensive or an umbrella term which includes a number of innovative and professional functions of HR department. Talent acquisition, talent retention, career management, performance management, succession planning and compensation management can be termed as the most important of all the determinants of talent management. The term Talent Acquisition would sound quite new to most of the people but the term is not new amongst the HR practitioners. Talent acquisition as a dimension of talent management refers to the process of attracting and recruiting the best talent available to help organisations own the right candidates with the desired skills for the right jobs in order to work against the right requirements.

### **II. OBJECTIVE**

- (a) To understand the concept, methods and strategies of Talent Acquisition in the selected industries in the service sector in Mumbai.
- (b) To seek the views of HR managers, Senior Officials and Employees of selected services sectors towards their Talent Acquisition strategies.

### **III. TALENT ACQUISITION**

It can be referred to as a strategic method to select, hire and onboard the best talents. Further, by adopting strategic talent acquisition process, organisations can create pipelines and anticipate future talent needs. Being a proactive approach, talent acquisition can facilitate competitive advantage, lower the hiring costs and improve the quality of hired in the long run. Many times, talent acquisition is considered to be synonymous with recruiting. In contrast to recruiting, talent acquisition is a broader concept as it includes elements such as talent acquisition planning and strategy, workforce segmentation, employment branding, candidate audiences, candidate relationship management, metrics and analytics<sup>1</sup>. Apart from these core elements, talent acquisition strategy even includes many other sub-elements---- Right selection of tools, technology and outsourcing partners help an organisation in framing an effective talent acquisition strategy.

The process of strategic talent acquisition possesses a broader vision of not only filling jobs today, but utilising the candidates that emerge out of a recruitment process as a source to fill up similar job positions in the future. The professionals engaged in the talent management team in an organisation have a better understanding of extracting the best from each and every talent as every talent is unique and has something of value to be offered. Thus, such professionals strive to facilitate relationships with these identified talents in order to establish a more successful chain or network, more referrals and more business.

### **IV. SERVICE SECTOR**

Let us now understand the five sectors, viz., Tourism Sector, Education Sector, Insurance Sector, Banking Sector and Health Sector, which form the core of the present research study.

#### **A. TOURISM SECTOR**

Maharashtra is one of the most favourite tourist centres in the country. The state capital city of Mumbai, one of the largest and most vibrant cities in the world, is visited by almost 6 million national and international tourists every year. Mumbai is known for its rich cultural heritages, natural beauty, beaches, entertainment industry, amusement parks and holy places. All these domestic and international tour operators and hotels provide ample job opportunities to youngsters in various fields like Travel Agents, Hotel Manager, Spa Manager, Tour Operator, Event and Conference Organiser, Tour Guides, Executive Chef, Sommelier, etc.

Due to labour intensive nature of tourism sector, it is necessary not only to select the right talent for the right job but also to maintain the right talent for longer period of time.

### **B. EDUCATION SECTOR**

Mumbai, apart from being the financial, commercial and entertainment capital of India, is also a major centre for education. The city has a large network of institutions imparting education right from pre-primary, primary, secondary and higher secondary level to graduate, post-graduate and professional levels. All these educational institutions right from pre-primary level to higher education level and professional level provide various job opportunities to people such as Directors/Principals, Teachers, Office and Clerical Staff, Trainers, Mentors, Administrators, etc. Again education is the core sector of the economy and therefore, talent management plays a very important role in the education sector.

### **C. INSURANCE SECTOR**

Considering the increasing complexities of urban lifestyle, high incidences of dreadful diseases and rising incidences of pre-mature deaths, life insurance and health insurance have become mandatory requirements for people. In addition to that other types of insurances like fire insurance, marine insurance and shop insurance businesses have expanded rapidly in the city. Insurance sector offers immense job opportunities to youth in the post- privatisation regime. Due to the establishment of large number of private sector insurance companies in India during the last two decades, many new job opportunities such as Actuary, Claim Adjuster, Claim Examiner, Insurance Investigator, Insurance Sales Agents, Insurance Underwriters and clerical jobs have arisen. Therefore in the competitive era talent management is of immense importance for insurance sector.

### **D. BANKING SECTOR**

Being the commercial capital of India, Mumbai is the epicentre of banking and finance industry of the nation. The city has headquarters of most of the banks of all types, viz., public sector banks, private sector banks and foreign banks. Also the city has dense network of bank branches. Banking and financial sector provides large number of job opportunities such as bank teller, bank marketing representative, relationship managers, internal auditor, branch manager, loan officer, data processing officer, loan consultants, etc. Therefore, talent management is of immense importance in banking and financial sector.

### **E. HEALTH SECTOR**

Mumbai city is also known for its world class affordable medical facilities and is one of the main centres of medical tourism in India. Every year, large number of patients from different parts of the world visit Mumbai city for medical treatment. Mumbai city has a number of government and private hospitals, private nursing homes, municipality-run dispensaries, health centres, etc. There is a vast network of supporting facilities for these large hospitals like pathologies, medical stores, pharmacy, etc. Health centre offers career options as medical assistants, nursing assistants, nurses, physicians, doctors, therapists, pharmacy technicians, diagnostic medical sonographers, clinical laboratory technicians, dental assistants, pharmacists, radiologists, etc. Thus, there is a need to manage talent in health sector too.

It can be seen in the above discussion that tourism sector, education sector, insurance sector, banking sector and health sector rely largely on human resource. With the increasing competition in all these fields there is an acute shortage of talents in each sector, quantitatively and more specifically qualitatively. Therefore, it is necessary to recruit, develop and retain right talent for the growth and development of the organisation in this competitive era. Therefore, the role of talent management in all these sectors is increasing rapidly. The human resource departments in most of the large and big sized organisations are being replaced by the talent management departments.

### **V. HYPOTHESIS**

#### **HYPOTHESIS-1**

H0: There is no significant interaction between Service sectors under consideration and the various components of talent acquisition strategies.

H1: There is a significant interaction between Service sectors under consideration and the various components of talent acquisition strategies.

### **VI. RESEARCH METHODOLOGY**

The researcher has made use of both primary as well as secondary data for achievement of objectives and establishment of hypotheses.



The researcher randomly distributed questionnaires to 500 respondents (100 from each sector under consideration), of which 386 completely filled questionnaires were received back. All these respondents were those dealing with HR issues in their respective organisations in one or the other capacity. Thus, the response rate is 77.20% (386/500), which is considered to be satisfactory. 386 questionnaires so received were scrutinised by the researcher and it was found that 361 of these questionnaires were complete in all respects and were fit for data analysis. The researcher randomly selected 350 questionnaires from them for analysis. Sampling unit refers to the basic units consisting all the elements of the of target population. The present study mainly consists of HR managers, Senior Executives in HR Department and Top Level Administrators from five service sectors selected for the purpose of the present study

## VII. FINDINGS:

### Q .1. Does your organisation have well-defined talent acquisition policy?

Table No.1.3 Existence of Well-defined Acquisition Policy

Clear Talent Acquisition Policy	Tourism Sector		Education Sector		Insurance Sector		Banking Sector		Health Sector	
	F	%	F	%	F	%	F	%	F	%
Yes	31	48	64	80	56	80	52	74	49	75
No	34	52	16	20	14	20	18	26	16	25
Total	65	100	80	100	70	100	70	100	65	100

Source: Field Survey

In the field survey 48% respondents from tourism sector, 80% respondents from education sector, 80% respondents from insurance sector, 74% respondents from banking sector and 75% respondents from health sector reported having a well-defined talent acquisition policy in their organisations.

### Q.2. How frequently does your organisation undertake talent acquisition drives?

Table No. 5.16 Frequency of Talent Acquisition Drives

Frequency of Talent Acquisition	Tourism Sector		Education Sector		Insurance Sector		Banking Sector		Health Sector	
	F	%	F	%	F	%	F	%	F	%
<a year	45	69	0	0	46	66	58	83	44	68
Yearly	20	31	18	23	21	30	11	16	21	32
Once in 3 years	0	0	2	3	3	4	1	1	0	0
Once in 5 years	0	0	11	14	0	0	0	0	0	0
> 5 years	0	0	49	61	0	0	0	0	0	0
Total	65	100	80	100	70	100	70	100	65	100

Source: Field Survey

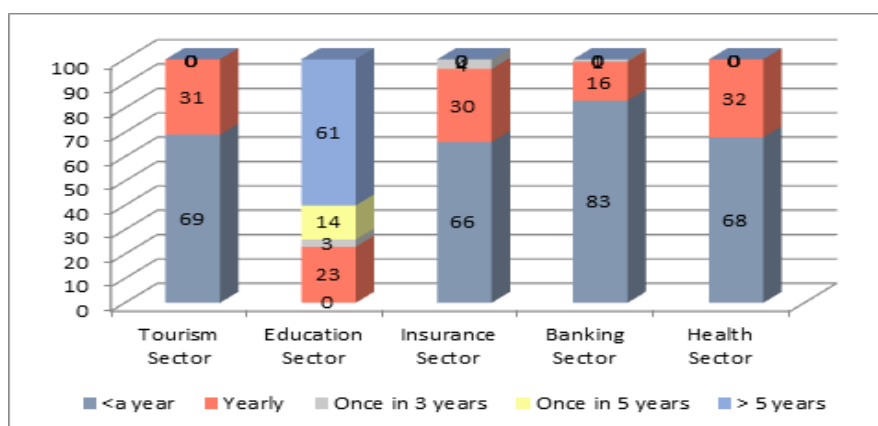


Fig. No. 5.16 Frequency of Talent Acquisition Drives (%)

## ANALYSIS:

### In the field survey:

- 69% respondents from the tourism sector, none from the education sector, 66% from the insurance sector, 83% from the banking sector and 68% from the health sector reported that their organisations undertake talent acquisition drives in less than one year.

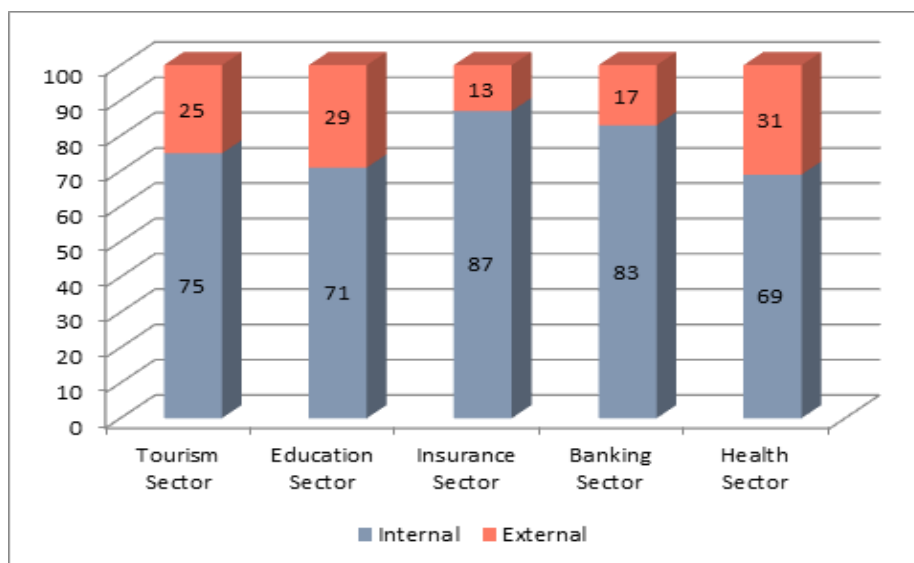
- 31% respondents from tourism sector, 23% respondents from education sector, 30% respondents from insurance sector, 16% respondents from banking sector and 32% respondents from health sector reported that their organisations undertake talent acquisition drives once in a year.
- None from tourism sector, 3% respondents from education sector, 4% respondents from insurance sector, 1% respondents from banking sector and none from health sector reported that their organisations undertake talent acquisition drives once in three years.
- None from tourism sector, 14% respondents from education sector and none from insurance sector, banking sector and health sector reported that their organisations undertake talent acquisition drives once in five years.
- None from tourism sector, 61% respondents from education sector and none from insurance sector, banking sector and health sector reported that their organisations undertake talent acquisition drives once in more than five years.

**Q.3. What sources does your organisation prefer for talent acquisition?**

**Table No. 5.17 Preferred Source of Talent Acquisition**

Sources of Talent Acquisition	Tourism Sector		Education Sector		Insurance Sector		Banking Sector		Health Sector	
	F	%	F	%	F	%	F	%	F	%
<b>Internal</b>	49	<b>75</b>	57	<b>71</b>	61	<b>87</b>	58	<b>83</b>	45	<b>69</b>
<b>External</b>	16	<b>25</b>	23	<b>29</b>	9	<b>13</b>	12	<b>17</b>	20	<b>31</b>
<b>Total</b>	<b>65</b>	<b>100</b>	<b>80</b>	<b>100</b>	<b>70</b>	<b>100</b>	<b>70</b>	<b>100</b>	<b>65</b>	<b>100</b>

Source: Field Survey



**Fig. No. 5.17 Preferred Source of Talent Acquisition (%)**

**ANALYSIS:**

**In the field survey,**

- 75% respondents from tourism sector, 71% respondents from education sector, 87% respondents from insurance sector, 83% respondents from banking sector and 69% respondents from health sector reported that their organisations prefer internal sources for talent acquisition,
- 25% respondents from tourism sector, 29% respondents from education sector, 13% respondents from insurance sector, 17% respondents from banking sector and 31% respondents from health sector reported that their organisations prefer external sources for talent acquisition,

**VIII. TESTING OF HYPOTHESES**

The researcher has made use of ANOVA Test for establishment of hypotheses under the consideration.

**HYPOTHESES:**

H0: There is no significant interaction between the service sectors under considerations and the various talent acquisition strategies.

H1: There is a significant interaction between the service sectors under considerations and the various talent acquisition strategies.

The above set of hypotheses has been tested or established using ANOVA Two Factor Test with Replication.

**INTERACTION:**

(1) The F-value ( $f$ ) (2.3215) is larger than the F Critical Value ( $f_{crit}$ ) (1.6587), therefore, we reject the null hypothesis.

(2) Also, the p-value (0.0018) is smaller than the significance level (0.05), therefore, we reject null hypothesis.

Therefore, reject Null Hypothesis at 5% significance level.

**NULL HYPOTHESIS:**

There is no significant interaction between the Service sectors under consideration and the various components of talent acquisition strategies. **Rejected**

**ALTERNATIVE HYPOTHESIS:**

There is a significant interaction between the Service sectors under consideration and the various components of talent acquisition strategies. **Accepted**

**IX. CONCLUSION AND SUGGESTIONS:**

The study concludes that There is an interaction between the sector and various components of talent management strategies but this interaction is not too significant.

**SUGGESTIONS:**

- a. Talent acquisition process should be undertaken with the efforts and involvement of all stakeholders of an organisation which include recruiters, hiring managers, HR team members, the prospective candidates, etc. All these stakeholders need to be kept updated by communicating with them on regular basis with regards to acquiring and recruiting talent and be made aware about their roles with regards to talent acquisition so that they all contribute inclusively in making the whole process an effective and objective one.
- b. In order to improve the whole process of talent acquisition and recruitment, organisations should take the assistance of various mobile recruitment tools, social networking sites, referral networking tools, applicant tracking system, social media platforms, etc. Organisations can also outsource the services of external professional agencies to reduce costs, bring greater efficiency and improve the whole process of talent acquisition and recruitment.
- c. Organisations should give the foremost priority and opportunity to its internal employees rather than hiring from outside as internal employees, being a part of the organisation possess a good knowledge of the functioning of various business processes and thus, they can be recruited directly for the newer positions. This may also promote higher morale among the internal staff. For this, the talent acquisition team should collaborate with the Learning and Development (L&D) Team to extract information about the skill gaps and create an environment, where internal job openings are made available to the internal employees.
- d. Data driven insights can also prove quite effective in improving talent acquisition processes, where data regarding cost per hire, quality of hire, time required to fill job vacancies, internal hire ratio and ratio of job offers accepted to job offers declined should be calculated. Based on this information, the management can take better decisions on acquiring talent.
- e. Organisations should strive to create a talent pipeline for meeting its current and future needs for talent by formulating workforce planning and undertaking skill gap analysis, scenario planning and headcount analysis.

**REFERENCES:**

1. Kohli Garima, (2013), 'Talent Acquisition Latest Trends', Indian Journal of Research, Volume – 3, Issue – 4, pp.223-226.

## Implementation of Data Transmission from PC To PC Using Lifi Technology

**D. Praveena Bai\*, Dasi Swathi and K Phani Rama Krishna**

Department of ECE, PVP Siddhartha Institute Of Technology, Vijayawada, India

### ABSTRACT

The function of verbal exchange may be very crucial in a day after day life. Communication may be of types: wi-fi or stressed verbal exchange. Wireless verbal exchange is typically desired over-stressed verbal exchange. Data transmission of the usage of Li-Fi is a hundred instances quicker while as compared to records transmission of the usage of Wi-Fi. In this paper, we gift a new mode of verbal exchange among laptops or PC's the usage of the Li-Fi era. Li-Fi refers to wi-fi verbal exchange structures that use mild LEDs as a medium in place of traditional RF, as utilized in the Wi-Fi era. Li-Fi yields more advantageous bandwidth, performance, connectivity & protection as compared to Wireless Fidelity. One of the advantages of Light Fidelity is that it is able to be utilized in electromagnetically diffused situations along with airways and thermonuclear strength stations with no interference. This paper employs this era for the transmission of the records designed with software programs and hardware requirements.

**Keywords:** Atmega8 IC, Transmitter, Receiver, puTTY, Solar Panel

### INTRODUCTION

With globalization and society-huge want for networking, there's a growing want for mobile networks and their usefulness, and an increase in person counts that use the Internet, restrained bandwidth capability makes it even more difficult to experience

Excessive records switch speeds and connect with a strong community. Due to the decreased bandwidth to be had with inside the RF range, this device could attain the essential threshold very soon. Radio waves, that may be used for transmitting records are the minor part of the electromagnetic spectrum. Their desires to be a manner to defeat forthcoming exhaustion. Li-Fi has a mile's wider records transmission spectrum. The essential idea in the back of this invention is the propagation of records via LED illumination, converting mild intensities that cannot be decided by human eyes. In reality, mild has been a huge part of our lives for heaps and heaps of years and has no outstanding sick impact. Li-Fi may have an important contribution in the direction of the easement of the large load which the existing Wi-Fi community is facing. It can supply moreover a frequency band of 400THz as compared to the only one found in Radio Frequency conversation that's 300GHz.

In general, the Li-Fi generation makes use of LEDs for transmitting any sort of information at excessive speed. In this paper, information transmission is from one PC to a different PC the usage of the Li-Fi generation.

There are such a lot of benefits to the usage of Li-Fi generation .The utilization of mild from the Light Emitting Diodes this is being formerly used for lights functions in the home, workplaces & mall, etc. will lessen power utilization. Thus, information transmission calls for zero extra energy, which makes it very cost-effective & power intensive.

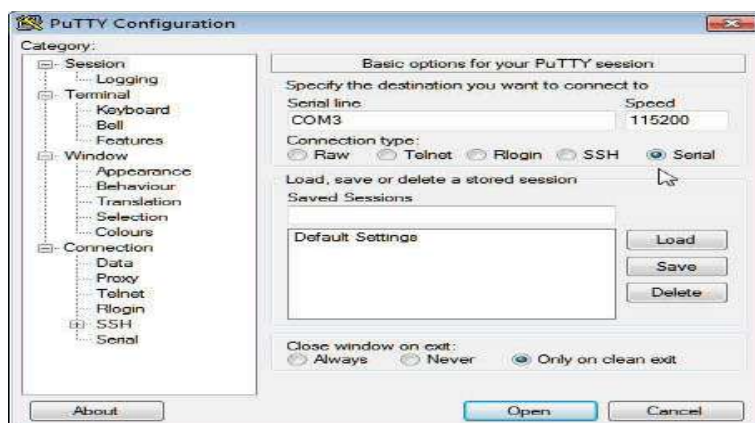
- As it isn't viable to skip via the partitions and obstacles it gives excessive protection and safety as compared to Wi-Fi generation
- As it isn't primarily based totally on the radio indicators there may be no radiation impact with inside the use of this generation. Because it entails the illuminated waves .
- Combining decreased latency, better bandwidth & better energy performance, permits Light Fidelity to acquire better information speeds, i.e., 1 Gbps or maybe more.
- This is not a hassle due to the fact that mild assets are everywhere. There may be internet wherein there is a delivery of sunshine. There are bulbs in all places -in houses, workplaces, commercial enterprise gadgets, or even craft that are probably used for transmitting information.

SrNo.	Comparison Basis	LIFI	WIFI
1.	Full Form	Light fidelity	Wireless fidelity
2.	Operation	Transmits data using bits with help of light from LED bulbs.	Transmits data with help of radio waves with help of WIFI router
3.	Security	Secured (cannot be hacked) as light is blocked by walls.	Not secured (can be hacked) as RF signal dry walls are transparent
4.	Interference	Do not have any interference issue similar to radio waves.	Has interference issue from nearby access points (routers)
5.	Spectrum	The Spectrum range is 1000times than Wi-Fi	It has radio spectrum range.
6.	Frequency	The frequency band is 100 times of Tera HZ	The frequency band is 2.4GHz,4.9GHzand 5GHz
7.	Speed	Fast speed internet (greater than 1- 3.5Gbps)	Comparatively slow speed (54-250 Mbps)
8.	Where To Use	Anywhere, where light source is present.	Inside a building. typically Within a array of WLAN communications , habitually inside a structure.
9.	Cost	Cheap as LED lamps are used.	Quiet expensive.
10.	Data transmission rate	Very high rate of data transmission due to visible light spectrum.	Transmission rate is slow as compared to Li-Fi as RF is used to communicate.
11.	System components	Lamp drivers, LED bulbs and light detectors will form	Routers have to be installed, devices like laptops, PDAs,

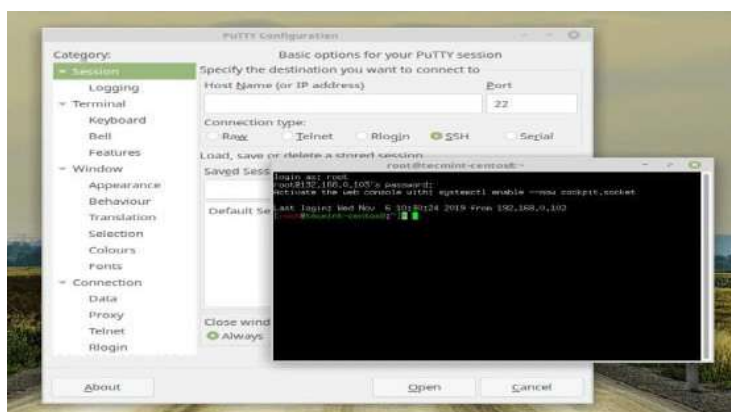
**Table 1:** Comparison of LIFI and WIFI

### SOFTWARE REQUIREMENTS

A. PuTTY is an unfastened implementation of SSH (and telnet) for PCs walking Microsoft Windows (it is also a term terminal emulator). You will locate PuTTY beneficial in case you need to get admission to an account on a Unix or different multi-consumer gadget from a PC (as an instance your personal or one in a web cafe). In the case of the University of Sussex, this will consist of customers of the valuable ITS Unix gadget and of the Unix structures supplied with the aid of using a few different faculties and units. The valuable ITS Unix gadget helps using SSH clients. Users of different structures ought to ask their gadget administrator if SSH is supported. PuTTY is an opportunity to telnet clients. Its number one benefit is that SSH gives a secure, encrypted connection to the faraway gadget. It's additionally small and self-contained and may be carried around on a floppy disk. This makes it best for getting access to Sussex structures securely from different places on the general public Internet, PuTTY is full-featured, strong and its terminal emulation is good. Since model 0.53, it additionally helps the by skip via printing function of VT100 terminals



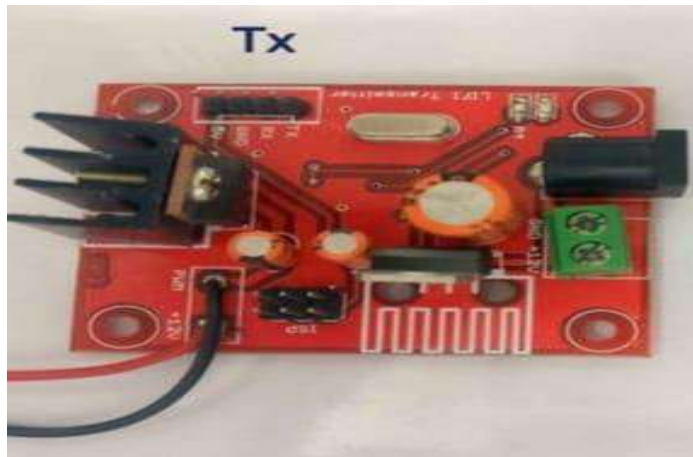
**Fig 3:**puTTY configuration



**Fig 4 :** puTTY sessio

## HARDWARE REQUIREMENTS TRANSMITTER

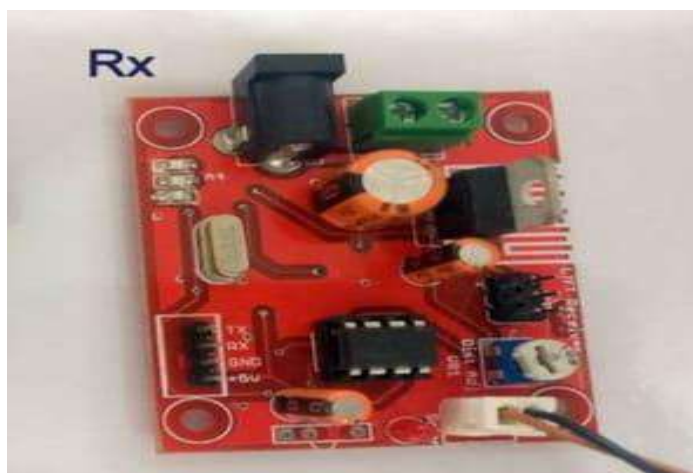
The transmitter is designed with Atmega8 IC. It is used for handling serial data. It includes capacitors and energy supply. The LiFi Transmitter is a custom-layout front-panel for seen mild communications (VLC). It has a huge bandwidth (25 MHz) to



**Fig 5:** : LiFi Transmitter

guide even the maximum worrying video streaming applications. The transmitter has an effective 5000K,186 lumens LED with an interchangeable lens mechanism.

## RECEIVER



**Fig 6:** : LiFi Receiver

The receiver is designed with Atmega8 IC. It is used for handling serial data. It includes capacitors, electricity supply, and a potentiometer. LiFi Receiver is a custom-layout front-panel for seen mild communications (VLC). It has an extensive bandwidth (20 MHz) to aid even the maximum annoying video streaming applications. The receiver functions as a photodetector with a field-of-view of 170° permitting a sturdy overall performance in non-line-of-sight conditions.

## LED

LiFi or VLC is a wi-fi communicate era primarily based totally on the usage of seen mild among the blue color (450nm) and the pink color (760nm), generated with the aid of using LEDs. Unlike Wi-Fi, which makes use of the radio as a part of the electromagnetic spectrum, LiFi makes use of the optical spectrum. Micro-sized Gallium Nitride (GaN) mild-emitting diodes (micro-LEDs) are robust applicants for VLC (seen mild communicate) and LiFi (mild fidelity) because of their excessive bandwidths. Segmented violet micro-LEDs are mentioned in this painting with electrical-to-optical bandwidths as much as 655 MHz.

## SOLAR PANEL

Most impressively, there may be no threat for statistics dribble. It does now no longer penetrate walls, the identical mild and the identical spectrum may be used without interference in communication. This innovation uses the growing availability of sun cells for diverse applications.



Fig 7 : Solar Panel

**USB TO TTL**



Fig 8: USB to TTL Interface

The USB TTL Serial cables are a number of USB to serial converter cables which offer connectivity among USB and serial UART interfaces. A variety of cables are to be had to present connectivity at 5V, 3.3V, or person certain sign stages with diverse connector interfaces. The AN-USB-TTL module is a cost-powerful manner to transform the TTL sign into a USB interface. When related to a PC USB port the AN-USB-TTL module is robotically detected and is mounted as a local COM port that is well-matched with any present serial verbal exchange application.

**WORKING**

By the usage of the transmitter module circuit linked with the LED, the entry is given in a single PC and via way of means of the usage of the receiver module circuit, the output gets generated in a different PC. The records that are given as entered in a single PC will receive identical records in any other PC with no connection among those PCs. This procedure is achieved on the premise of Li-Fi technology.

The transmitter as proven in parent 1 has the subsequent operations: choice of the file for transmission then extracts the information inside the shape of 1's and 0's. codes it to serial information on a GPIO, strategies the information and turns the LED

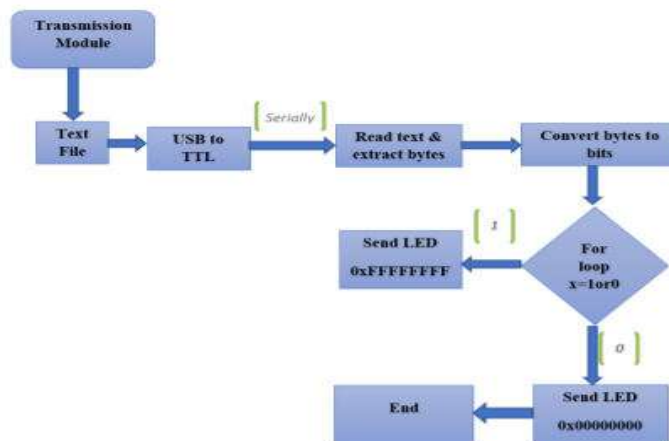


Fig 9:Block diagram of the transmitter

ON or OFF consistent with the information encoded. Text to be transmitted is given as an entrance to the transmitter PC reserved for serially transmitting the textual content. The information with inside the transmitter

PC serially sends the textual content through a USB to TTL converter cable that's related to the COM3 serial port of the transmitter PC with the baud charge of 9600. Information is now written in putty configuration to transform the acquired textual content into binary bits. The receiver extracts the bits from the textual content and sends them to the LED related to the PC. When the transmitted bit is '1' the LED activates and while the transmitted bit is '0' the LED is switched off.

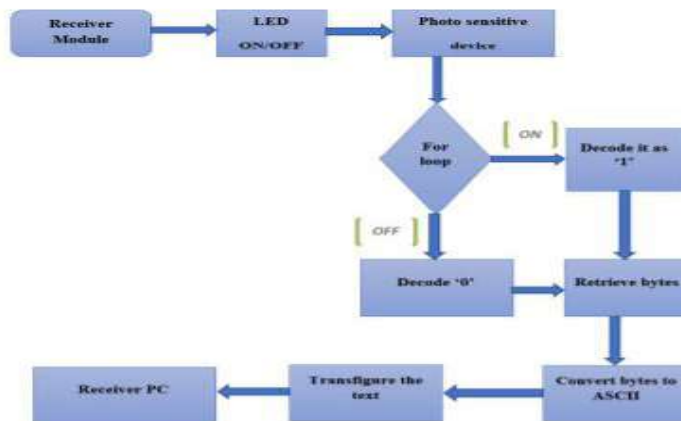


Fig 10:Block diagram of Reciever

The receiver module as proven in determine 2 calls for nearly the identical additives as that of the transmission module. The number one distinction is the solar panel. The receiver module has the characteristic of receiving the transmitted bits from LED at the sun panel & sending it to the receiver PC through the USB to TTL converter. The configuration of Raspberry Pi stays identical to the only utilized in the transmitter module. The receiver module does the opposite engineering of the operations with inside the transmitter module. mild encountered from the Light Emitting Diode is captivated through the photosensitive thing which performs the function of a sensor and transfers the output to the receiver PC and the unique textual content is recovered through the use of a solar panel. Solar panels cannot be at once related to the transmitter module however the facts are transmitted through the lifi technology.

Analog assets like a sun panel to be related to the receiver, which acts as an ADC is needed (analog-to-virtual converter). The photosensitive aspect detects the On & OFF of the LED and is despatched to the receiver. The textual content written at the putty mode of the recipient sends 1/zero the usage of a sequential port to the processing software program. The processing software program gets the facts with inside the serial port. The processing putty configuration for studying the facts at the serial port, retrieving the bytes, showing the unique facts despatched from the transmitter, and showing it at the Receiver PC

Connect Tx of LIFI to Rx of TTL, Rx of LIFI tx of TTL Power supply 12v ( 5v regulator is on board)LED supply is soldered to Tx board.ATMEGA8 IC is used on Tx & Rx forums for managing serial records. If the LED is on, it transmits a virtual 1, if it off transmits a zero. The LEDs may be switched on and stale very quickly, which offers first-class possibilities for transmitting records. Hence all that we required is a few LEDs and a controller that codes records into the one's LEDs.On one-cause all of the records at the net might be streamed to a lamp motive force while the led is became at the microchip converts the virtual records in the shape of mild. A mild-touchy device (photodetector) gets the sign and converts it again into authentic records. This approach of the usage of speedy pulses of mild to transmit records wirelessly is technically called

### Visible light communication



Fig 11:Hard ware setup implementation



## RESULT & DISCUSSION

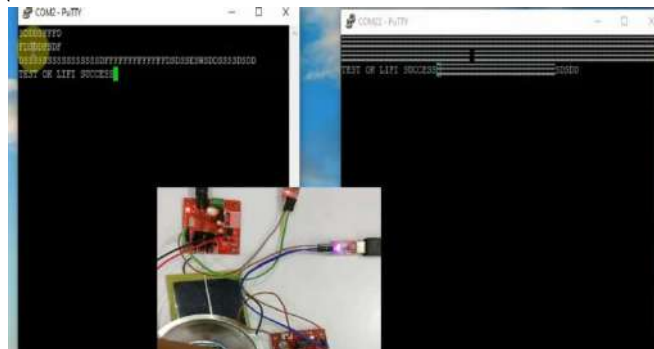


Fig 12: Data transfer from PC to PC

This paper developed a data transmission system between two PCs based on Li-Fi technology that utilizes two Arduino UNO boards, one at the transmitter part and another at the receiver part. This paper developed a data transmission system between two PCs based on Li-Fi technology that utilizes two Arduino

UNO boards, one at the transmitter part and another at the receiver part. This paper developed a data transmission system between two PCs based on Li-Fi technology that utilizes two Arduino UNO boards, one at the transmitter part and another at the receiver part. This paper developed a data transmission system between two PCs based on Li-Fi technology that utilizes two Arduino UNO boards, one at the transmitter part and another at the receiver part. This paper developed a data transmission system between two PCs based on Li-Fi technology that utilizes two Arduino UNO boards, one at the transmitter part and another at the receiver part.

This paper developed a PC to PC data transmission system based on Li-Fi technology that utilizes two Atmega8 IC one on transmitter side another one on receiver side. After the experiment was conducted the data transmission rate is not affected up to 15 cm distance. If the distance increased, this leads to the data transmission with noise.

## CONCLUSION

Quite glaringly improvement in studies on Light Fidelity will screen that it will be had to each person with inside the coming times. This era will advantage most or maybe in VC a navy sectors for its beneficial aid in secured verbal exchange. A top-notch exchange in regular lifestyles on each component will display if the Li-Fi era supersedes Wireless Fidelity and exceptional broadband connections. While Li-Fi has many blessings, information provides us one-of-a-type exposure to factors elements, and statistics delivered at a totally rapid rate, which is this technology's largest challenge.. LI-Fi is a quick and reasonably priced wireless communication technique. There is a developing call for higher bandwidths, faster, and additional comfortable statistics transmission further to environmental and simply human pleasant is all fulfilled with the aid of using the Li-Fi

## REFERENCES

1. H. Haas *et al.*, "Introduction to indoor networking concepts and challenges in LiFi," in *Journal of Optical Communications and Networking*, vol. 12, no. 2, pp. A190-A203, February 2020, doi: 10.1364/JOCN.12.00A190.
2. N. Zheludev, "The life and times of the LED—a 100-year history," *Nat. Photonics* 1, 189–192 (2007).
3. J. R. Barry, J. M. Kahn, E. A. Lee, and D. G. Messerschmitt, "Highspeed nondirective optical communication for wireless networks," *IEEE Netw.* 5, 44–54 (1991)
4. S. Nakamura, T. Mukai, and M. Senoh, "High-power GaN pn junction blue-light-emitting diodes," *Jpn. J. Appl. Phys.* 30, L1998–L2001 (1991).
5. Y. Tanaka, T. Komine, S. Haruyama, and M. Nakagawa, "Indoor visible communication utilizing plural white LEDs as lighting," in *Proceedings of the 12th IEEE International Symposium on Personal, Indoor and Mobile Radio Communications* (2001), vol. 2, pp. 81–85
6. J. Grubor, S. C. J. Lee, K. D. Langer, T. Koonen, and J. W. Walewski, "Wireless high-speed data transmission with phosphorescent white-light LEDs," in *Proceedings of the 33rd European Conference and Exhibition of Optical Communication—* (2007), pp. 1–2

7. N. T. Le, M. S. Ifthekhar, Y. M. Jang, and N. Saha, "Survey on optical camera communications: challenges and opportunities," *IET Optoelectron.* 9, 172–183 (2015).
8. H. Haas, L. Yin, Y. Wang, and C. Chen, "What is LiFi?" *J. Lightwave Technol.* 34, 1533–1544 (2016)
9. L. Zeng, D. O'Brien, H. Le-Minh, K. Lee, D. Jung, and Y. Oh, "Improvement of data rate by using equalization in an indoor visible light communication system," in *4th IEEE International Conference on Circuits and Systems for Communications (ICCSC)* (2008), pp. 678–682.
10. H. Schulze, "Frequency-domain simulation of the indoor wireless optical communication channel," *IEEE Trans. Commun.* 64, 2551–2562 (2016).
11. A. Gomez, K. Shi, C. Quintana, R. Maher, G. Faulkner, P. Bayvel, B. C. Thomsen, and D. O'Brien, "Design and demonstration of a 400 Gb/s indoor optical wireless communications link," *J. Lightwave Technol.* 34, 5332–5339 (2016).
12. H. Ma, L. Lampe, and S. Hranilovic, "Hybrid visible light and power line communication for indoor multiuser downlink," *J. Opt. Commun. Netw.* 9, 635–647 (2017)

## Cerium Doped Tin Oxide Nanoparticles (Ce-SnO<sub>2</sub> Nps) Synthesized From Ipomoea Carnea Flower Extract and Assessment of Its Antimicrobial Activity

Manivannan Prasanth and Gurusamy Muruganandam

P.G. and Research Department of Chemistry, A.V.V.M. Sri Pushpam College, (Affiliated to Bharathidasan University) Poondi.613 503, Tamil Nadu, India

### ABSTRACT

The aim of the study is to synthesize different concentrations (2,4,6 and 8%) of cerium doped tin oxide nanoparticles (Ce-SnO<sub>2</sub> NPs) using Ipomoea carnea flower extract and evaluation of its antimicrobial activity. The prepared samples have been investigated by UV spectrum, Powder XRD pattern, SEM, TEM and EDAX analysis. From the XRD pattern of different concentrations (2, 4, 6, and 8%) of Ce-SnO<sub>2</sub> NPs grain size in the range of 31.28 to 40.03nm. TEM, SEM and EDAX for various concentrations confirmed the surface morphology of SnO<sub>2</sub> nanoparticles. The antimicrobial activities of cerium doped tin oxide nanoparticles (Ce-SnO<sub>2</sub> NPs) were studied against bacteria and fungi using the standard disc diffusion method. The different concentrations (2, 4, 6, and 8%) of Ce-SnO<sub>2</sub> NPs tested against Escherichia coli, Bacillus subtilis Staphylococcus aureus, Pseudomonas aeruginosa and Candida albicans. The antimicrobial activity was increased directly proportional to the concentration-dependent manner. Experimental results demonstrated that 8% Ce doped tin oxide nanoparticles (Ce-SnO<sub>2</sub> NPs) exhibited the minimized nanoparticle size and maximum antimicrobial effect compared to other concentrations of Ce-SnO<sub>2</sub> nanoparticles.

Keywords: Ipomoea carnea flower, Cerium doped tin oxide nanoparticles, Characterization, Antimicrobial activity

### INTRODUCTION

Nanotechnology, abbreviated as nanotech is the intriguingly emerging modern technology that involves the manipulation of bulk materials into nanosized materials ranging from 1 to 100 nm. Nanotechnology encompasses almost all the domains known to mankind, it is physics, chemistry, human biology, genetics, energy sciences, food industry, electronics, aviation, medicine or any other field of scientific research [1]. The scaling down of the size of materials increases its surface to volume ratio, thereby bringing about novel physical, biological, chemical, electrical, and optical properties to the material. These properties of nanomaterials and nanoparticles have led to their versatile applications. Thus, nanotechnology produce materials with light weight, higher screening, better electrical conductivity, more strength, more durability, and better reactivity with other significant traits [2].

Nanoparticles have been long known for their antimicrobial behavior against gram-positive and gram-negative bacteria pathogens, and other [3]. Metal oxide nanoparticles serve as antimicrobial agents owing to their large surface area [4]. Out of several metal oxide nanomaterials, scientists have more interest in SnO<sub>2</sub> nanoparticles because of their novel properties such as high chemical stability, high transparency, and low electrical sheet resistance, etc. [5,6]. The modified SnO<sub>2</sub> also has great technical and scientific interests because of its diverse applications, e.g., transparent conducting electrodes, gas sensors, as electrodes in lithium-ion batteries, electronic devices, dye-based solar cells, H<sub>2</sub> generation, etc. [7-9,1]. Other than these applications, SnO<sub>2</sub> has been seeking attention as an antimicrobial agent and has played an essential role against the growth of various bacterial strains like *Staphylococcus aureus*, *E. coli* [10]. This work involves the synthesis and characterization of Ce doped SnO<sub>2</sub> nanoparticles using *Ipomoea carnea* flower and evaluates its antimicrobial activity against microbes.

### EXPERIMENTAL METHODS

#### Collection of Materials

The flower of *Ipomoea carnea* was collected in January 2019 from Poondi, Thanjavur District, Tamil Nadu, India. Tin (II) chloride hexahydrate, sodium hydroxide, distilled water and ethanol were purchased from Merck chemical co private limited.

#### Preparation of Alcoholic Extract

Fresh *Ipomea carnea* Leaf were cut and washed with distilled water. The extraction procedure was as follows: 10g of Leaf was added to 100mL of ethanol and soaked for 24h. The obtained extraction was filtered using Whatman No.1 filter paper and the filtrate was collected and stored at room temperature for further usage.

### Synthesis of Cerium Doped Tin Oxide Nanoparticles

For the preparation of Cerium doped Tin Nanoparticles, 100ml of 0.1M Tin (II) chloride dihydrate ( $\text{SnCl}_2 \cdot 2\text{H}_2\text{O}$ ) solution and different atomic percentage of ammonium ceric nitrate was added with 100ml of *I carnea* Flower extract, we get the Ash colour solution. This solution was stirred constantly at room temperature for 4 hours. The colloidal particles dried at hot air oven at  $80^\circ\text{C}$  for one hour. Further the precipitate was calcinated at  $350^\circ\text{C}$  for 3hours. The synthesised nanoparticles further characterized by UV spectrum, XRD, SEM, TEM and EDAX.

### Determination of Anti-Bacterial Activity

The antimicrobial activity was performed by disc diffusion method followed by NCCLS [11] and Awoyinka *et al.*, [12]. Antibiogram was done by disc diffusion method using test sample. Petri plates were prepared by pouring 30 ml of NA medium for bacteria. The test organism was inoculated on solidified agar plate with the help of micropipette and spread and allowed to dry for 10 mins. The surfaces of media were inoculated with bacteria from a broth culture. A sterile cotton swab is dipped into a standardized bacterial test suspension and used to evenly inoculate the entire surface of the Nutrient agar plate. Briefly, inoculums containing of bacterial strains *Staphylococcus aureus* (MTCC 3160), *Bacillus subtilis* (MTCC 441), *Escherichia coli* (MTCC 732) *Pseudomonas aeruginosa* (MTCC 1035) and *Candida albicans* (MTCC 183) were spread on Nutrient agar plates. Using sterile forceps, the sterile filter papers (6 mm diameter) containing each  $20\mu\text{l}$  of samples were laid down on the surface of inoculated agar plate. The plates were incubated at  $37^\circ\text{C}$  for 24 h for bacteria and 48hrs for fungi. Each sample was tested in triplicate.

## RESULTS AND DISCUSSION

### UV Spectrum studies

The nanoparticles were primarily characterized by UV-Visible spectrophotometer, which proved to be a very useful technique for the analysis of nanoparticles. It is commonly accepted that size and shape-controlled nanoparticles in aqueous suspensions are examined by UV-Vis spectroscopy. In the UV-Vis spectra of the reaction mixture of different concentrations of (2, 4, 6 and 8%) of Ce doped  $\text{SnO}_2$  nanoparticles, the peak was observed at 338nm. A similar report was observed by Mani Bharathi *et al* [13] who reported the peak at 340nm in 2 and 4% of Ce doped  $\text{SnO}_2$ .

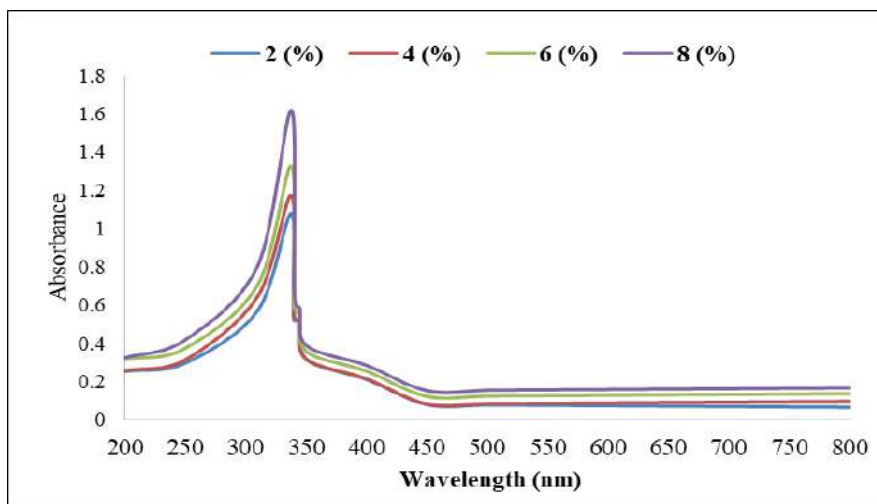
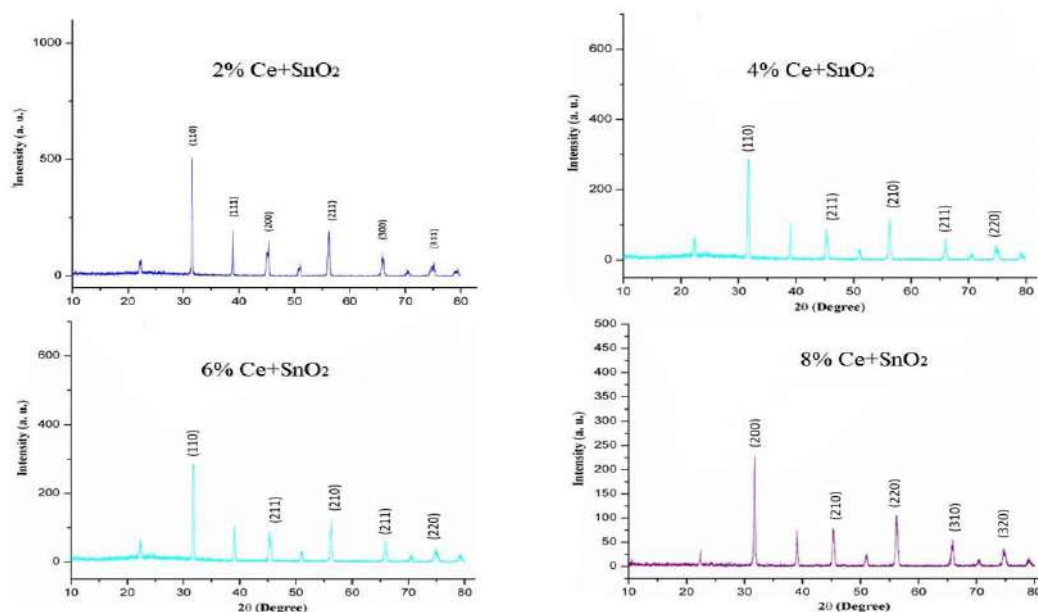


Figure 1 UV visible spectrum of different concentrations of (2, 4, 6 and 8%) of cerium doped tin oxide nanoparticles (Ce-SnO<sub>2</sub> NPs)

### X ray diffraction study

The Powder X-ray direction pattern of the synthesized Ce doped  $\text{SnO}_2$  nanoparticles has been shown in the Figure 2. It shows a structure with tetragonal symmetry space group] and shows clear reflection at (110), (111), (200), and (211) crystallographic planes corresponding to JCPDS file no. 41-1445 [14, 15]. The absence of any other characteristic peaks rule out possibilities of impurities or other species within the lattice represents high phase purity. The Grain crystalline size D can be calculated by using the Scherer's equation (i.e.,)  $D = k\lambda / (\beta \cos\theta)$ , where 'k' is the shape factor, ' $\lambda$ ' is the wavelength of x-rays used,  $\beta$  is the full width at half maximum of the prominent Bragg peak and  $\theta$  is the Bragg angle. From the small crystalline size indicated the presence of broad peaks. When the increasing the dopant level of Ce, it in indicates that the intensity level  $\text{CeO}_2$  peaks also increased, it's shows that, the peak shifted towards the higher angle. The crystallite size of the different

concentrations (2, 4, 6 and 8%) of Ce doped SnO<sub>2</sub> samples were calculated. When the concentration of doped increases the grain sizes also decreased. Crystallite size of different concentrations (2, 4, 6 and 8%) Ce doped SnO<sub>2</sub> nanoparticles are shown in the Figure 1 and Table 1 to 4.



**Figure 2** X-ray diffraction (XRD) analysis of different concentrations of (2, 4, 6 and 8%) of cerium doped tin oxide nanoparticles (Ce-SnO<sub>2</sub> NPs)

**Table 1** The grain size of Cerium doped Tin oxide (2%) nanoparticle

2θ of the intense peak (deg)	Miller indices (hkl)	θ of the intense peak (deg)	FWHM of intense peak (β) radians	Size of the particle (D) nm
31.57	110	15.785	0.2755	29.8065
38.89	111	19.445	0.3393	29.4146
45.07	200	22.535	0.3933	23.9948
56.19	211	28.095	0.4903	17.6199
66.23	300	33.115	0.5779	116.7424
75.32	311	37.66	0.6572	12.3974
Average nanoparticle size				40.0338

**Table 2** The grain size of Cerium doped Tin oxide (4%) nanoparticle

2θ of the intense peak (deg)	Miller indices (hkl)	θ of the intense peak (deg)	FWHM of intense peak (β) radians	Size of the particle (D) nm
31.74	110	15.87	0.276984	29.9002
45.25	111	22.625	0.394882	25.31412
56.39	210	28.195	0.492097	16.36885
66.23	211	33.115	0.577967	109.5316
75.32	220	37.66	0.657293	12.28328
Average nanoparticle size				38.679

**Table 3** The grain size of Cerium doped Tin oxide (6%) nanoparticle

2θ of the intense peak (deg)	Miller indices (hkl)	θ of the intense peak (deg)	FWHM of intense peak (β) radians	Size of the particle (D) nm
31.69	110	15.845	0.276548	29.78852
39.01	111	19.505	0.340427	29.65407
45.29	200	22.645	0.395231	25.69685
56.17	211	28.085	0.490177	16.61386
66.34	220	33.17	0.578927	76.88853
Average nanoparticle size				35.728

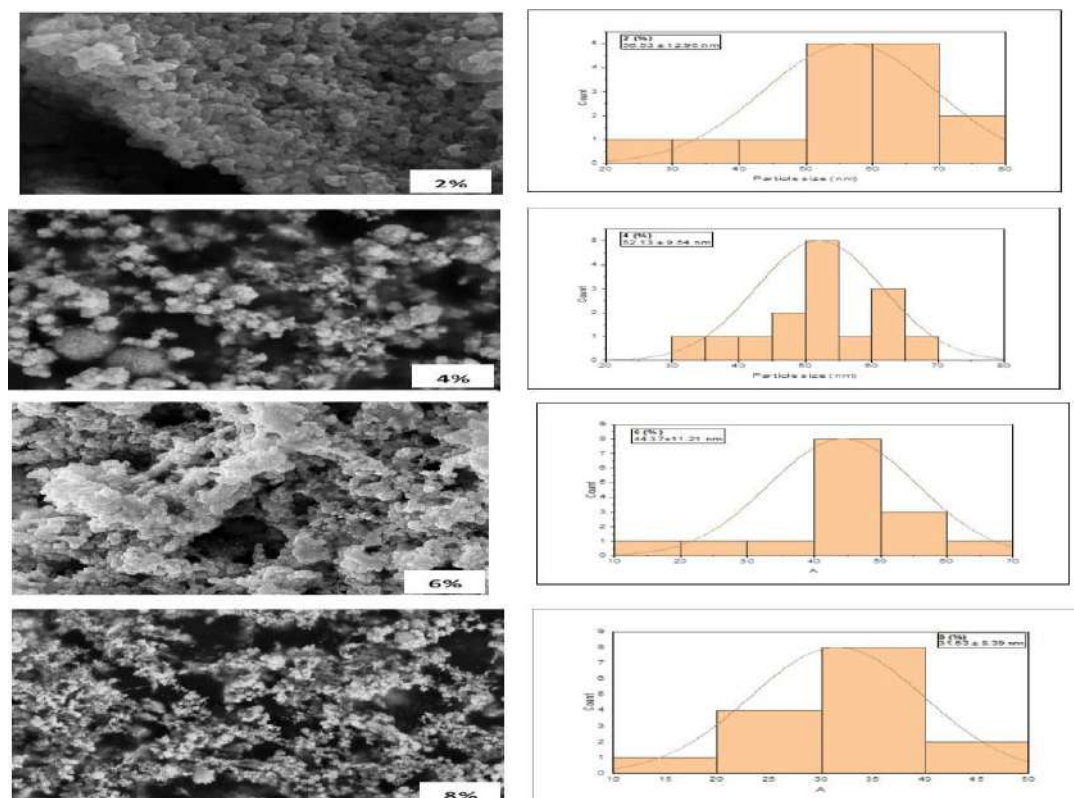
**Table 4** The grain size of Cerium doped Tin oxide (8%) nanoparticle

2θ of the intense peak (deg)	Miller indices (hkl)	θ of the intense peak (deg)	FWHM of intense peak (β) radians	Size of the particle (D) nm
31.77	200	15.885	0.277246	29.97918
45.47	210	22.735	0.396802	27.71893
56.37	220	28.185	0.491922	16.382
65.57	310	32.785	0.572208	69.94054
75.09	320	37.545	0.655285	12.42126
Average nanoparticle size				31.288

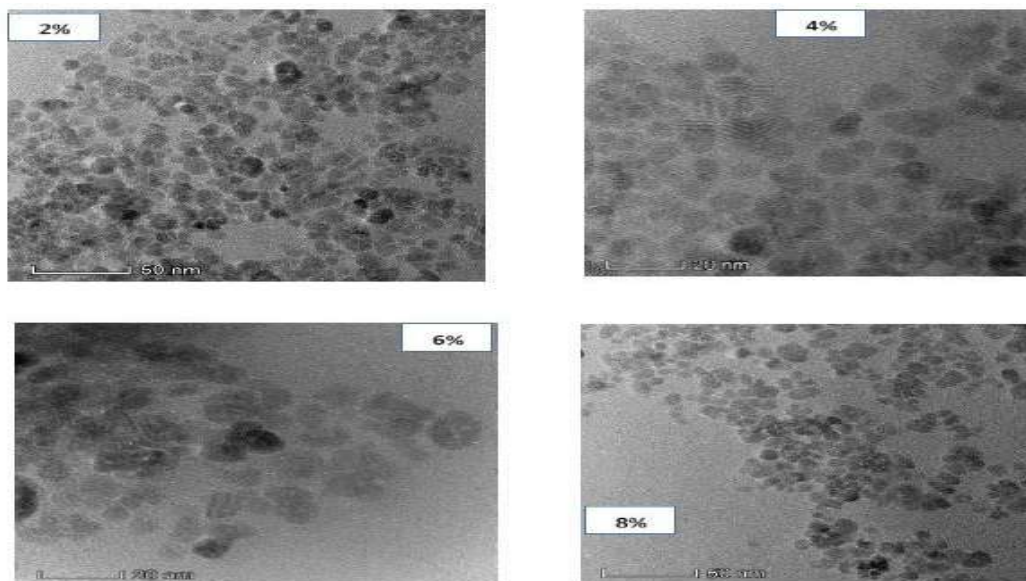
### SEM and TEM analysis

The scanning electron microscope (SEM) uses a focused beam of high-energy electrons to generate a variety of signals at the surface of solid specimens. The signals that derive from electron-sample interactions reveal information about the sample including external morphology (texture), chemical composition, crystalline structure and orientation of materials making up the sample. SEM is used for morphological characterization of different concentrations (2,4,6 and 8%) of Ce-SnO<sub>2</sub> NPs and represent in figure 3. It is limited in some morphological analysis because it produces limited information regarding the true population and average size distribution. SEM analysis showed the ranges from 31.56 – 56.53 nm and the average particles size were found to be 56.53 ± 12.96nm for 2% Ce-SnO<sub>2</sub> NPs, 52.13 ± 9.54nm for 4% Ce-SnO<sub>2</sub> NPs, 44.37 ± 11.21nm for 6% Ce-SnO<sub>2</sub> NPs and 31.53 ± 8.39nm for 8% Ce-SnO<sub>2</sub> NPs.

Transmission electron microscopy (TEM) is a microscopic technique whereby a beam of electrons is transmitted through an ultra-thin specimen TEM is regarded as the best among other electron microscopy techniques for the determination of morphological identities of Ce-SnO<sub>2</sub> NPs. Transmission electron microscopy (TEM) is a microscopic technique whereby a beam of electrons is transmitted through an ultra-thin specimen. TEM analysis (Figure 4) showed the tetragonal nature of the nanoparticles in both methods. Most of the nanoparticles gathered and only a little of them were dispersed when observed under SEM. The Ce doped SnO<sub>2</sub> NPs yields were comprised of abundant consistent nanostructured agglomerated particles. In accumulation, the circulation of NPs with the superficial of SnO<sub>2</sub> NPs is clear. The present study agrees with an earlier report by Bhawna *et al.* [1] who observed tetragonal symmetry.



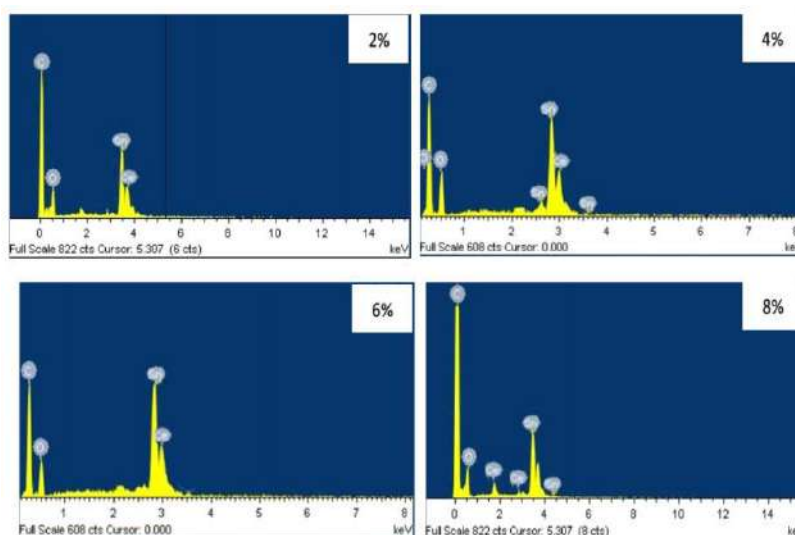
**Figure 3** SEM analysis of different concentrations of (2, 4, 6 and 8%) of cerium doped tin oxide nanoparticles (Ce-SnO<sub>2</sub> NPs)



**Figure 4** TEM analysis of different concentrations of (2, 4, 6 and 8%) of cerium doped tin oxide nanoparticles (Ce-SnO<sub>2</sub> NPs)

**EDX ANALYSIS**

Figure 5 spectacles the EDX spectrum of different concentrations (2, 4, 6 and 8%) of Ce doped SnO<sub>2</sub> and 8% of Ce doped SnO<sub>2</sub> NPs which leak the incidence of (O, C, Sn and Ce) elements in the corresponding samples. Furtherly, no impurity peak was identified, hence it has been recognized that Ce ions consume excellently imported the Sn in the SnO<sub>2</sub> lattice, which specifies the clearness of related composition. Even so, the uniform distribution nature was accessible in the essence of Sn, O and Ce species remained established. Table 5 represents EDX elemental analysis showing the atomic percentage of different concentrations of Ce doped SnO<sub>2</sub>. The cerium atomic percentage was directly proportional to the concentrations. Present study agreement with Mani Bharathi *et al* (2017) [13]who reported the similar reports in 2 and 4% Ce doped SnO<sub>2</sub>.



**Figure 5** EDX analysis of different concentrations of (2, 4, 6 and 8%) of cerium doped tin oxide nanoparticles (Ce-SnO<sub>2</sub> NPs)

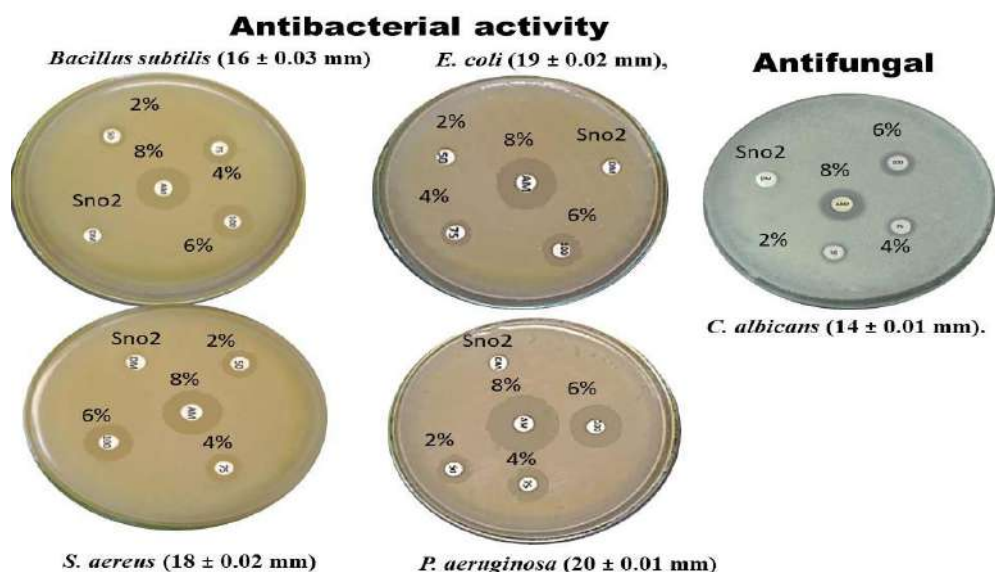
**Table 5** Atomic percentage of different concentrations of (2, 4, 6 and 8%) of cerium doped tin oxide nanoparticles (Ce-SnO<sub>2</sub> NPs)

Elements	Ce-SnO <sub>2</sub> NPs			
	2%	4%	6%	8%
O (L)	80.65	72.24	60.78	54.14
Ce (L)	1.58	3.98	5.45	7.28
Sn (L)	15.25	21.64	26.73	32.95
C (K)	2.52	2.14	7.04	5.63

### ANTIMICROBIAL ACTIVITY

The antimicrobial actions of concentrations (2, 4, 6 and 8%) of Ce-doped SnO<sub>2</sub> NPs were verified via agar disc diffusion method against strains *Staphylococcus aureus*, *Bacillus subtilis*, *Escherichia coli*, *Pseudomonas aeruginosa* and *Candida albicans*. The antimicrobial effectiveness was scrutinized from the zone of inhibition (ZOI) established around the sample areas. Figure 6 displays the pictures of ZOI established around the obtained samples, and reliable values are charted in Table 5. All the Ce-doped SnO<sub>2</sub> NPs illustrate improved bacteriological and fungal retardant performance equated to the pristine sample besides the experienced pathogenic microbes. The inadequate antibacterial and antifungal movement detected for the pristine Ce SnO<sub>2</sub> NPs might be owing to its short diffusivity which inhibits the interface between the nanomaterials and microbial kinds [16]. Among the tested gram-positive and negative bacteria, a gram-positive bacterium attains a higher degradation efficiency than gram-negative bacteria. It is reported that gram-positive bacteria attain a higher inhibition zone than gram-negative bacteria due to the variation in the cell membrane of the bacteria. The heightened antimicrobial efficacy detected for the 8% of Ce doped SnO<sub>2</sub> NPs might be owed to the contact amid their amended shells and microbes owing to adsorption-desorption and also chemical/physical capabilities.

Owing to the enriched gathering of 8% of Ce doped SnO<sub>2</sub> NPs on the superficial of the microbes, the cytoplasmic phospholipid cell membrane interruption takes place triggering the cell death [17]. It has fine identified that reactive/regenerative oxygen species (ROS) are being fashioned once the NPs enter the cell barrier of microbes owing to their surface response on the cell wall exterior. The ROS kinetics of hydrogen peroxide (H<sub>2</sub>O<sub>2</sub>), superoxide radical anions (<sup>o</sup>O<sup>2-</sup>), (<sup>o</sup>OH) hydroxyl radicals and organic hydroperoxides source react with cell damage owing to the oxidative strain on the wall of the cell membrane [18]. The augmented steadiness and diminished crystallite size might furthermore be the potential object for the improved antimicrobial action of the Ce doped SnO<sub>2</sub> NPs. The observed result shows that on increasing the concentration of Ce doped SnO<sub>2</sub> nanoparticle in the bacterial and fungal broth an increase in the inhibition zone was achieved which suggest the good antimicrobial activity of the as-synthesized Ce doped SnO<sub>2</sub> nanoparticles.



**Figure 6** Antimicrobial activity of different concentration of (2, 4, 6 and 8%) of cerium doped tin oxide nanoparticles (Ce-SnO<sub>2</sub> NPs) and tin oxide (SnO<sub>2</sub>)

**Table 6** Antimicrobial activity of different concentrations of (2, 4, 6 and 8%) of cerium doped tin oxide nanoparticles (Ce-SnO<sub>2</sub> NPs) and tin oxide (SnO<sub>2</sub>)

Bacterial and fungal name	SnO <sub>2</sub> (mm)	2% Ce+SnO <sub>2</sub> (mm)	4% Ce+SnO <sub>2</sub> (mm)	6% Ce+SnO <sub>2</sub> (mm)	8% Ce+SnO <sub>2</sub> (mm)
<i>E. coli</i> [G (-)]	6 ± 0.0	10 ± 0.05	13 ± 0.02	15 ± 0.02	19 ± 0.02
<i>Staphylococcus aureus</i> [G (-)]	8 ± 0.02	10 ± 0.02	15 ± 0.03	17 ± 0.02	18 ± 0.02
<i>Pseudomonas aeruginosa</i> [G(+)]	5 ± 0.02	12 ± 0.05	15 ± 0.02	18 ± 0.02	22 ± 0.01
<i>Bacillus subtilis</i> [G(+)]	8 ± 0.02	10 ± 0.05	12 ± 0.02	18 ± 0.02	23 ± 0.03
<i>Candida albicans</i> (Fungal)	2 ± 0.02	5 ± 0.02	10 ± 0.02	12 ± 0.02	14 ± 0.01

Values are expressed as Mean ±SD for triplicates



## CONCLUSION

Economical synthesis of Ce doped SnO<sub>2</sub> nanoparticles were prepared by using *Ipomoea carnea* flower extract. From, the XRD pattern studies identified a structure with a tetragonal symmetry space group (JCPDS card no: 41-1445). The results of nanoparticle size were decreased due to the concentration of dopant increases. The SEM, TEM and EDAX studies confirm the presence of Ce doped SnO<sub>2</sub> nanoparticles. The antimicrobial activity of different concentrations (2, 4, 6 and 8%) of Ce doped SnO<sub>2</sub> showed a concentration-dependent manner. These nanomaterials could be used against bacterial and fungal infection mediated diseases.

## REFERENCES

1. Bhawna Gupta, A., Kumar, P., Tyagi, A., Kumar, R., Kumar, A., Singh, P., et al. (2020). Facile synthesis of N-Doped SnO<sub>2</sub> nanoparticles: a cocatalyst-free promising photocatalyst for hydrogen generation. *ChemistrySelect* 5, 7775–7782.
2. Vargas-Reus, M. A., Memarzadeh, K., Huang, J., Ren, G. G., and Allaker, R. P. (2012). Antimicrobial activity of nanoparticulate metal oxides against peri-implantitis pathogens. *Int. J. Antimicrob. Agents* 40, 135–139.
3. Azam, A., Ahmed, A. S., Oves, M., Khan, M. S., Habib, S. S., and Memic, A. (2012). Antimicrobial activity of metal oxide nanoparticles against Gram-positive and Gram-negative bacteria: a comparative study. *Int. J. Nanomed.* 7:6003.
4. Raghunath, A., and Perumal, E. (2017). Metal oxide nanoparticles as antimicrobial agents: a for the future. *Int. J. Antimicrob. Agents* 49, 137–152
5. Jarzebski, Z., and Marton, J. (1976a). Physical properties of SnO<sub>2</sub> materials: I. preparation and defect structure. *J. Electrochem. Soc.* 123:199
6. Jarzebski, Z., and Morton, J. (1976). Physical properties of SnO<sub>2</sub> materials: III. Optical properties. *J. Electrochem. Soc.*, 123, 333
7. Jiang, Q., Zhang, X., and You, J. (2018). SnO<sub>2</sub>: a wonderful electron transport layer for perovskite solar cells. *Small* 14:1801154
8. Xie, J., Huang, K., Yu, X., Yang, Z., Xiao, K., Qiang, Y., et al. (2017). Enhanced electronic properties of SnO<sub>2</sub> via electron transfer from graphene quantum dots for efficient perovskite solar cells. *Acs Nano* 11, 9176–9182.
9. Wang, Z., Han, T., Fei, T., Liu, S., and Zhang, T. (2018). Investigation of microstructure effect on NO<sub>2</sub> sensors based on SnO<sub>2</sub> nanoparticles/reduced graphene oxide hybrids. *ACS Appl. Mater. Interf.* 10, 41773–41783.
10. Phukan, A., Bhattacharjee, R. P., and Dutta, D. K. (2017). Stabilization of SnO<sub>2</sub> nanoparticles into the nanopores of modified montmorillonite and their antibacterial activity. *Adv. Powder Technol.* 28, 139–145.
11. NCCLS. (1993) National Committee for Clinical Laboratory Standards. Performance standards for antimicrobial disc susceptibility tests. PA: NCCLS Publications 25.
12. Awoyinka, O.A., Balogun I.O. and Ogunnow, A.A. (2007). Phytochemical screening and in vitro bioactivity of *Cnidocolus aconitifolius* (Euphorbiaceae). *J. Med. Plant Res*, 1: 63-95.
13. Mani Bharathi P.M.R., Amutha T., Rameshbabu M. and Prabha K. (2017) Synthesis and Investigation of Ce doped Tin oxide (SnO<sub>2</sub>) nanoparticles. *International Research Journal of Engineering and Technology.* 4(1), 334- 340.
14. Kumar, M., Bhatt, V., Abhyankar, A. C., Kim, J., Kumar, A., Patil, S. H., et al. (2018). New insights towards strikingly improved room temperature ethanol sensing properties of p-type Ce-doped SnO<sub>2</sub> sensors. *Sci. Rep.* 8, 1–12.
15. Kumar, V., Bhawna, Y. adav, S. K., Gupta, A., Dwivedi, B., Kumar, A., Singh, P., et al. (2019a). Facile synthesis of Ce-doped SnO<sub>2</sub> nanoparticles: a promising Photocatalyst for hydrogen evolution and dyes degradation. *Chemistry Select* 4, 3722–3729
16. Chandran D, Nair LS, Balachandran S et al (2015) Structural, optical, photocatalytic, and antimicrobial activities of cobalt-doped tin oxide nanoparticles. *J Sol Gel Sci Technol* 76:582–591.

17. Shanmugam V, Jeyaperumal KS (2018) Investigations of visible light driven Sn and Cu doped ZnO hybrid nanoparticles for photocatalytic performance and antibacterial activity. *Appl Surf Sci* 449:617–630.
18. Shanmugam V, Muppudathi AL, Jayavel S, Jeyaperumal KS (2018) Construction of high efficient g-C<sub>3</sub>N<sub>4</sub> nanosheets combined with Bi<sub>2</sub>MoO<sub>6</sub>-Ag photocatalysts for visible-light-driven photocatalytic activity and inactivation of bacterias. *Arab J Chem.*4, 472-485.

## A Review on the Recent Developments on Solid Desiccant-Based Technology in HVAC Applications

Alice D'souza<sup>1</sup>, Pragnesh Brahmhatt<sup>2</sup> and Ratnesh Shukla<sup>3</sup>

<sup>1,3</sup>Government Engineering College, Bharuch, India

<sup>2</sup>Government Engineering College, Dahod, India

### ABSTRACT

The HVAC (Heating ventilation and air conditioning) industry is constantly innovating to reduce the GWP (Global warming Potential). It is the need of the hour that HVAC professionals look for greener alternatives since the industry is mainly dominated by the VCR system. Handling of the latent load in any cooling application is a major concern. Solid desiccants which are hygroscopic substances can efficiently handle latent load and can prove to be a viable option to remove moisture. Desiccant technology over the years has progressed extensively. This paper presents the latest advances in the field of solid desiccant dehumidification which can be applicable to HVAC. The past decade has seen a lot of advances in the utilization of solid desiccants. This review covers the vast area in which solid desiccants are utilized, how the related technology is getting better by the day.

### INTRODUCTION

Solid desiccant base air conditioning systems are gaining popularity especially in areas dealing with high latent load. Studies by(Dhar & Singh, 2001) have shown that for moisture removal, solid desiccant-based hybrid air conditioning systems are able to give substantial energy savings as compared to the conventional vapour compression refrigeration-based air conditioning systems. Industries handling food production, pharmaceutical production, industrial chemicals and goods storage tend to show high dependency on dry air, as it is utilized for improving the process, product and conditions(Rambhad et al., 2016). (Zheng et al., 2014) reviewed the recent progress on desiccant materials that can be adopted in Solid Desiccant Cooling (SDC) systems. Focus was given to composite desiccants, nanoporous inorganic materials and polymeric desiccants. Adsorption isotherms were compared, regeneration ability was also considered for full use of low-grade thermal energy, regeneration temperature as low as 40°C was achieved. This paper focuses on the work carried out by various researchers utilizing solid desiccants in different ways to dehumidify air. From the review carried out, it is evident that some applications of utilizing solid desiccants such as desiccant wheels have been used by most researchers whereas use of packed bed have been less explored. Hence this paper draws a comparison between the research work carried out by many researchers making use of solid desiccants through different technologies. This paper identifies the area which are less explored and provides a road map to novices to carry out research work in less ventured areas to efficiently use solid desiccants.

### 1. Solar energy in desiccant air conditioning

(Guidara et al., 2013)developed the design of a solar air conditioning unit coupled with a desiccant dehumidifier as shown in Fig. 1. Solar collector was used to produce the water for regeneration. Each component was modeled mainly on thermal and mass balances. Simulation was carried out for three climate cases 1) Cold & humid 2) Hot & dry 3) Moderate. Results obtained suggested that the solar air conditioner performed successfully.

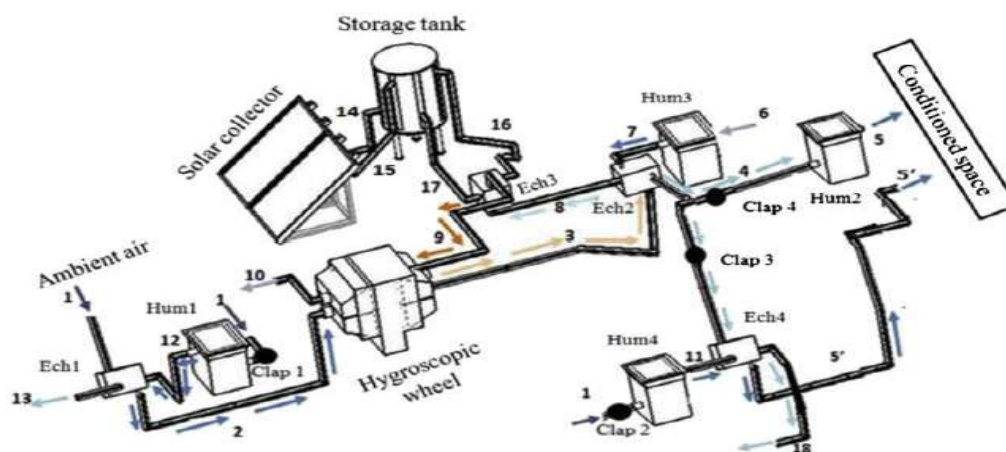


Fig 1.Design of the solar air conditioning unit.[5]

(Misha et al., 2015) developed a solar assisted solid desiccant dryer which could work well even at low solar radiation. The desiccant wheel made the drying process more effective. In the first stage, the desiccant material adsorbed the moisture from the ambient air. A heat exchanger further sensibly heated the dry air. Solar energy was used for regeneration of the desiccant wheel. (Gadalla & Saghafifar, 2016) suggested the two-stage desiccant air conditioning system as opposed to the conventional desiccant air conditioning system for improved C.O.P. Moreover, the Maisotsenko cooling cycle was also incorporated which resulted in less dependency on solar heating. (Misha et al., 2016) used solar energy as primary energy source in a hybrid desiccant system assisted by a solar dryer. This resulted in low electrical consumption. The desiccant wheel improved the drying air quality with sensible and latent effectiveness of 74% and 67% respectively. A similar study was conducted by (Merabti et al., 2017) for Algerian coastal climate, where too, a solar assisted system was coupled with a desiccant based evaporative cooling system. The results provided acceptable comfort conditions. (Jani et al., 2018b) conducted an extensive literature survey on application of solar energy in hybrid desiccant cooling. Comparative analysis of different solar powered desiccant cooling cycle was made. Work done by various researchers was compiled. The review highlighted the potential of using solar energy in desiccant-based cooling applications. Various researchers (Gadalla & Saghafifar, 2016; Guidara et al., 2013; Merabti et al., 2017; Misha et al., 2015, 2016) have conducted successful work and research on the use of solar energy in desiccant-based air conditioning. It can be concluded that use of solar energy in desiccant-based air conditioning is a viable option and holds potential for development in comparison to the conventional vapour compression refrigeration system.

## 2. Solid Desiccant technology used in heat pumps

(Jiang et al., 2013) proposed the use of solid desiccants in heat exchangers used in a heat pump. The conventional evaporators and condensers were directly coated with solid desiccant materials. Fin and tube type heat exchangers were employed for this task. (Nie et al., 2015) investigated the energy performance of the heat pump coupled with a solid desiccant cooling system. (Tu et al., 2013) suggested the use of square plates having honey comb structure which should be coated with the desiccant material to be used along with a conventional heat pump. The plates change positions for dehumidification and regeneration between the process air duct and the regeneration duct respectively. The high temp end of the heat pump was used for regeneration while low temperature end was used for cooling the process air.

## 3. Solid desiccant in packed bed

Utilization of solid desiccants in a Solid Desiccants and Air Conditioning system is of prime importance. The following researchers have worked on a packed bed solid desiccant system. (Ramzy et al., 2015) proposed the intercooling of the desiccant bed as shown in Fig 2. to eliminate the heat of adsorption and increase the utilization heat of adsorption and increase the utilization of solid desiccant. The optimum bed length and intercooler location depended on the operating parameters. Intercoolers were not recommended for high air flow rates.

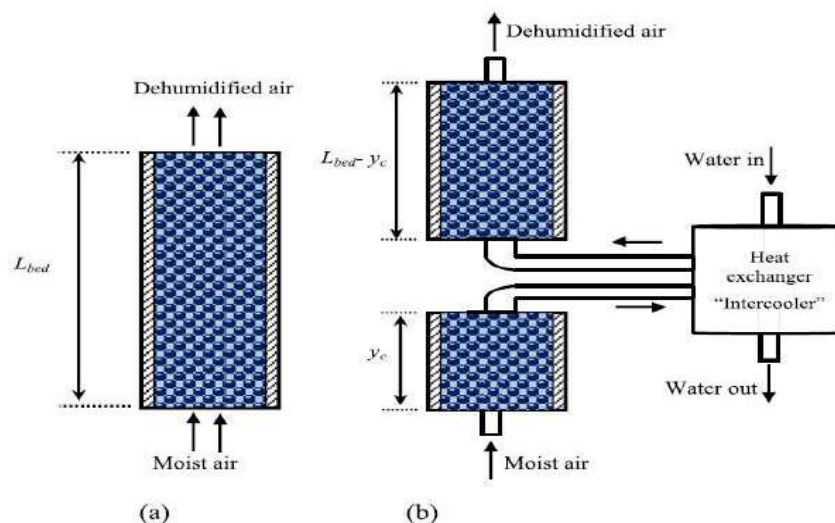
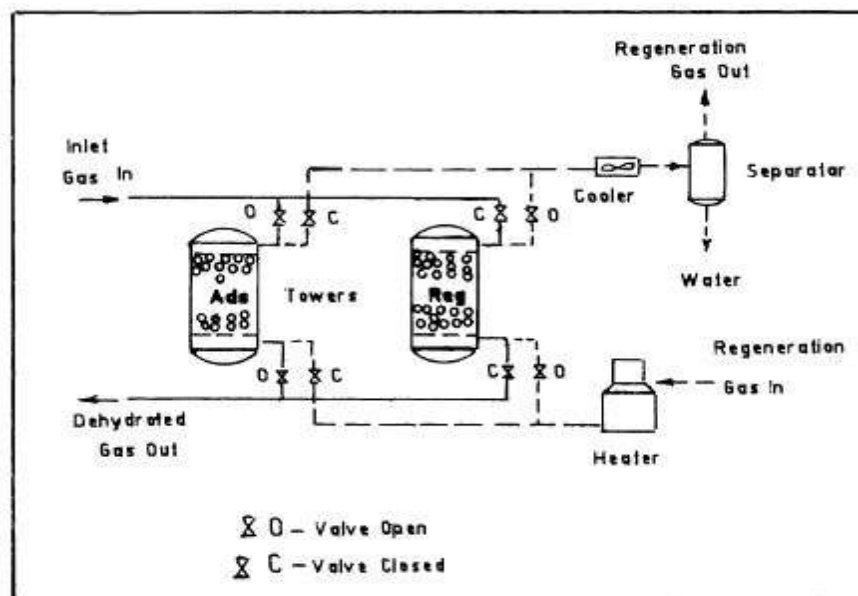


Fig 2. Physical model of silica gel bed in adsorption mode, (a) conventional and (b) intercooled packed beds.

[14]

(Gandhidasan, 2005) used a two tower, solid desiccant dehydrator as shown in Fig 3. The system also consisted of a heater to provide necessary heat for regeneration. It was found that the desiccant mass required for

dehydration was highly dependent on the operating temperature. Higher the regeneration temperature meant lesser quantity of regeneration gas was needed.



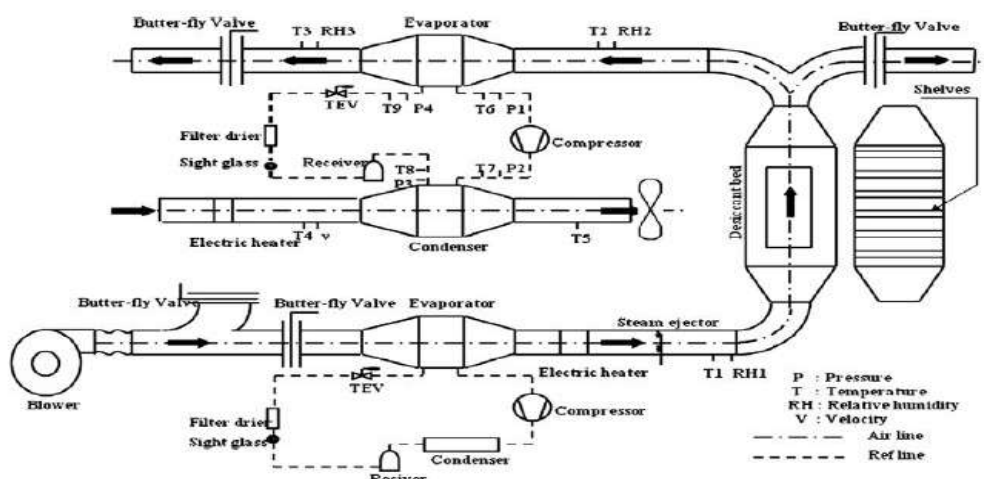
**Fig 3.** Schematic of a two-tower solid desiccant dehydrator (Ramzy et al., 2015)

Desirable properties of solid desiccants for packed beds (Gandhidasan, 2005; Ramzy et al., 2015).

- 1) Large surface area of solid desiccants is desirable for high capacity and high mass transfer rate.
- 2) Easy and economical to regenerate.
- 3) Packed bed units are sensitive to pressure drop. Hence minimum resistance to gas flow is desirable as this can ensure low pressure drop.
- 4) High mechanical strength to resist crushing and dust formation.
- 5) Solid desiccants must be cost effective, non-corrosive, nontoxic and chemically inert.

The volume must have minimum or no changes during adsorption and desorption. They must be able to retain their strength even when wet.

(Fatouh et al., 2009) Integrated a packed bed solid desiccant with R407C conventional vapour compression refrigeration system and found that the system resulted in reduction in compressor electric power and number of electric unit (KWh) by 10.2%. Increase in mass flow rate of regenerated air resulted in reduction in regeneration time whereas, increase in the regeneration temperature reduced the regeneration time by almost 25%. The schematic of the system is as shown in fig



**Fig 4.** Schematic diagram of the experimental test rig for packed bed solid desiccant integrated with the R407C vapour compression refrigeration system.

#### 4. Solid Desiccant wheel

(Panaras et al., 2007) proposed a methodology using a case study of a solar desiccant air conditioning system applied to a residential building. By using this methodology, he was able to define the attainable working range for comfort air conditioning.

**4.1 Desiccant wheel rotation** (Eicker et al., 2012) conducted experimental investigation on different commercially available desiccant wheels and found that the optimal rotational speed to be lower for lithium chloride rotors in comparison to silica gel rotors. (Angrisani et al., 2013) studied the wheel rotation and its effect on the performance of the desiccant-based system. It was found that if the wheel rotated too fast, the desiccant was not able to adsorb the moisture similarly in case of too slow rotation, possibility of saturation increased. (Zendejboudi, 2016) Six desiccant wheels with diameters 44cm, 55cm and 77cm using silica gel and molecular sieve desiccants under different conditions were experimentally evaluated. Process outlet temperature, dehumidification effectiveness, moisture removal capacity, sensible energy ratio, and regeneration specific heat input effectiveness were examined as functions of regeneration temperature, volume flow rate and rotation speed at different wheel diameters and materials.

**4.2 Active and Passive desiccant wheels** (Nóbrega & Brum, 2012) conducted a comparative study on the roles played by heat and mass transfer in passive and active adsorptive air dehumidification. The passive desiccant wheels were usually applied as an energy saving technique for vapour compression cooling systems, reducing the load on the cooling coil from handling the humidity of outside ventilation air stream. While the active desiccant wheels were made to facilitate a thorough dehumidification of outside ventilation air.

**4.3 Non adiabatic desiccant wheel** (Narayanan et al., 2013) The conventional desiccant wheels have a major setback, excessive heating of the supply air and desiccant during the dehumidification process. This increases the partial pressure of the water vapour on the desiccant material, resulting in less amount of moisture removal from the air. To battle this problem, a non-adiabatic wheel design was investigated. This wheel consisted of an internal heat transfer structure with alternative channels for dehumidification and for indirect cooling of the dehumidification process.

**4.4 Regeneration methods applied in desiccant wheels** (Guidara et al., 2013) proposed a system consisting of a solar thermal collector to produce hot air which could be used for regeneration of the desiccant wheel. Mathematical models based on thermal mass balance was developed for the proposed system. (Misha et al., 2015) developed a system which used solar energy to heat water with the help of a solar collector. Two heat exchangers transferred heat to the air, which was later utilised to regenerate the desiccant wheel. (Chen et al., 2015) To regenerate a silica gel/polymer composite desiccant wheel, it was suggested that heat from a heat pump be used as the heat source at 40 – 50 °C. The heat pump's adsorption heat was utilised to dehumidify the processed air by condensing it, resulting in a high relative humidity situation that aided the desiccant wheel's functioning.

#### 5. Regeneration using Electro Osmosis

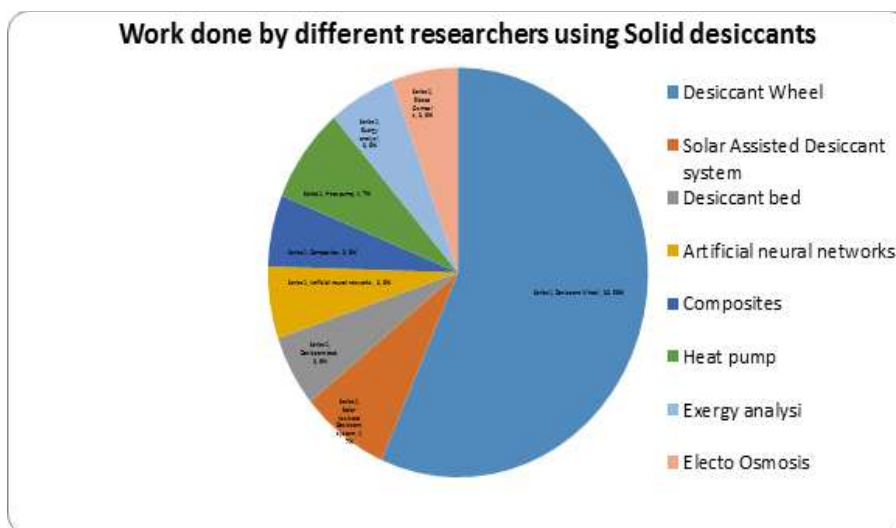
(Li et al., 2012) Highlighted the potential of Electro -osmosis based regeneration for solid desiccants, specifically for dehumidification systems in HVAC. Sufficient mass flow was obtained for water removal rate inside the solid desiccant array with 20 V DC voltage on the installed electrodes. (Qi et al., 2010) Emphasised on the potential of Electro osmosis regeneration method for the solid desiccant system. By the help of detailed experimental validation, he investigated the possibility and performance of a novel electro-osmotic regeneration method for solid desiccant system. Where the system could adsorb the water from the moist air and be regenerated by the electro osmotic force at the same time. (Qi et al., 2011) observed that electro-osmotic regeneration for the solid desiccant had many merits such as regeneration without the heat source; energy-saving and simple structure. In this paper; four possible improvement methods were investigated experimentally; including changing the material of anode; changing layout of cathode; applying the interrupted power and optimizing the electrical field strength.

**6. Artificial Neural Network** (Koronaki et al., 2012) The neural network model was developed to examine the performance of an air conditioning system which used silica gel desiccant wheel, conventional heat pump and heat exchangers to improve the outlet air of the system. The accuracy and the feasibility of the method was verified and showed good agreement with ANN model outputs and measured data. (Jani et al., 2016b) developed an artificial neural network (ANN) to predict the performance of a rotary desiccant dehumidifier for varying inlet air conditions. Test results of the experiments conducted were used as target data to train the ANN model. Close agreement was observed between the experimental test results and the predictions by the ANN model.

**7. Composite Desiccant Utilization** (Rajamani et al., 2017) discusses one step approach to synthesize a nanostructured desiccant. It mainly consisted of biopolymer template, metal oxyhydroxide and a lyophilic metal salt. The solid composite displayed good adsorption capacity, low regeneration temperature and ecofriendly nature. (Zheng et al., 2016) studied the important features of silica gel- LiCl composite desiccant. Composite desiccant was coated on aluminium sheets and fabricated for experimental investigation in heat exchangers.

(Zheng et al., 2015) investigated composite desiccant which was produced by impregnating LiCl into pores of activated carbon and activated carbon fibre. Its performance was investigated for its application in desiccant coated heat exchangers.

**8. Exergy Analysis** (Lior & Al-Sharqawi, 2005) presented an exergy analysis of the water vapor adsorption process in a desiccant air stream system, for laminar humid air flow over a desiccant flat bed with constant and variable properties, as well as in a desiccant-lined channel, and for turbulent humid air flow in such a channel, for different turbulence intensities. (Tu et al., 2015) This paper investigates the performance of desiccant dehumidification and cooling systems. Six types of systems (systems A–F) were studied based on a theoretical inquiry. It was noted that the performance reduced as the system changed from being reversible to irreversible. The performance of system E, which consisted of a desiccant wheel, an actual heat recovery exchanger, and an actual single-stage heat pump, represented the relatively high standards that actual systems can achieve.



**Fig 5.** The above chart shows the magnitude of research done by different scholars in the respective fields using solid desiccants.

The following table 1 indicates the use of different techniques used for dehumidification and regeneration by different researchers

Sr No	Year	Author	Technique used for dehumidification & regeneration	Sr No	Year	Author	Technique used for dehumidification & regeneration
1	2001	(Gandhidasan, 2005)	Packed bed	18	2016	(Jani et al., 2016c)	Desiccant Wheel
2	2007	(Panaras et al., 2007)	Desiccant Wheel	19	2016	(Misha et al., 2016)	Desiccant Wheel
3	2009	(Fatouh et al., 2009)	Packed bed	20	2016	(Tu et al., 2016)	Desiccant Wheel
4	2011	(Panaras et al., 2011)	Desiccant Wheel	21	2016	(Zendehboudi, 2016)	Desiccant Wheel
5	2012	(Eicker et al., 2012)	Desiccant Wheel	22	2017	(Fong & Lee, 2018)	Desiccant Wheel
6	2012	(Nóbrega & Brum, 2012)	Desiccant Wheel	23	2017	(Fong & Lee, 2018)	Desiccant Wheel
7	2013	(Angrisani et al., 2013)	Desiccant Wheel	24	2017	(Goodarzia et al., 2017)	Desiccant Wheel
8	2013	(Guidara et al., 2013)	Desiccant Wheel	25	2017	(Jani et al., 2017)	Desiccant Wheel

9	2013	(Narayanan et al., 2013)	Desiccant Wheel	26	2017	(Narayanan, 2017)	Desiccant Wheel
10	2015	(Guan et al., 2015)	Desiccant Wheel	27	2018	(Higashi et al., 2018)	Desiccant Wheel
11	2015	(Intini et al., 2015)	Desiccant Wheel	28	2018	(Jani et al., 2018a)	Desiccant Wheel
12	2015	(Misha et al., 2015)	Desiccant Wheel	29	2018	(Jani et al., 2018c)	Desiccant Wheel
13	2015	(Tu et al., 2015)	Desiccant Wheel	30	2018	(Jani et al., 2018b)	Desiccant Wheel
14	2015	(Ramzy et al., 2015)	Packed bed	31	2018	(Tu et al., 2018)	Desiccant Wheel
15	2016	(Chen et al., 2016)	Desiccant Wheel	32	2018	(Zendehboudi et al., 2018)	Desiccant Wheel
16	2016	(Jani et al., 2016a)	Desiccant Wheel	33	2018	(Zhou et al., 2018)	Desiccant Wheel
17	2016	(Jani et al., 2016b)	Desiccant Wheel				

The following table 2 indicates the use of different techniques for regeneration implemented by different researchers

Sr No	Year	Author	Heat utilization for regeneration	Sr No	Year	Author	Heat utilization for regeneration
1	2010	(Qi et al., 2010)	Electro- osmosis	8	2015	(Misha et al., 2015)	Solar Energy
2	2011	(Qi et al., 2011)	Electro- osmosis	9	2016	(Misha et al., 2016)	Solar Energy
3	2012	(Li et al., 2012)	Electro- osmosis	10	2016	(Wang et al., 2016)	Solar Energy
4	2013	(Guidara et al., 2013)	Solar Energy	11	2016	(Gadalla & Saghafifar, 2016)	Solar Energy
5	2013	(Jiang et al., 2013)	Heat Pump	12	2017	(Merabti et al., 2017)	Solar Energy
6	2013	(Tu et al., 2013)	Heat Pump	13	2017	(Tu et al., 2017)	Heat Pump
7	2014	(Nie et al., 2015)	Heat Pump				

## 9. CONCLUSION

From the review conducted it can be concluded that use of solid desiccants is gaining popularity for applications where there is a need for dehumidification. Relatively considerable amount of research has been conducted on solar assisted solid desiccant cooling systems. Desiccant wheels have been extensively used for dehumidification and regeneration of solid desiccants. However, a huge potential lies in the utilization of packed desiccant beds also, for the process of dehumidification and regeneration which can be further explored.

## REFERENCES

- Angrisani, G., Roselli, C., & Sasso, M. (2013). Effect of rotational speed on the performances of a desiccant wheel. *Applied Energy*, 104, 268–275. <https://doi.org/10.1016/j.apenergy.2012.10.051>
- Chen, C. H., Hsu, C. Y., Chen, C. C., & Chen, S. L. (2015). Silica gel polymer composite desiccants for air conditioning systems. *Energy and Buildings*, 101, 122–132. <https://doi.org/10.1016/j.enbuild.2015.05.009>
- Chen, C. H., Hsu, C. Y., Chen, C. C., Chiang, Y. C., & Chen, S. L. (2016). Silica gel/polymer composite desiccant wheel combined with heat pump for air-conditioning systems. *Energy*, 94, 87–99. <https://doi.org/10.1016/j.energy.2015.10.139>
- Dhar, P. L., & Singh, S. K. (2001). Studies on solid desiccant based hybrid air-conditioning systems. *Applied Thermal Engineering*, 21(2), 119–134. [https://doi.org/10.1016/S1359-4311\(00\)00035-1](https://doi.org/10.1016/S1359-4311(00)00035-1)



5. Eicker, U., Schürger, U., Köhler, M., Ge, T., Dai, Y., Li, H., & Wang, R. (2012). Experimental investigations on desiccant wheels. *Applied Thermal Engineering*, 42, 71–80. <https://doi.org/10.1016/j.applthermaleng.2012.03.005>
6. Fatouh, M., Ibrahim, T. A., & Mostafa, A. (2009). Experimental investigation on a solid desiccant system integrated with a R407C compression air conditioner. *Energy Conversion and Management*, 50(10), 2670–2679. <https://doi.org/10.1016/j.enconman.2009.06.020>
7. Fong, K. F., & Lee, C. K. (2018). Impact of adsorbent characteristics on performance of solid desiccant wheel. *Energy*, 144, 1003–1012. <https://doi.org/10.1016/j.energy.2017.12.113>
8. Gadalla, M., & Saghafifar, M. (2016). Performance assessment and transient optimization of air precooling in multi-stage solid desiccant air conditioning systems. *Energy Conversion and Management*, 119, 187–202. <https://doi.org/10.1016/j.enconman.2016.04.018>
9. Gandhidasan, P. (2005). Quick performance prediction of liquid desiccant regeneration in a packed bed. *Solar Energy*, 79(1), 47–55. <https://doi.org/10.1016/j.solener.2004.10.002>
10. Goodarzia, G., Thirukonda, N., Heidari, S., Akbarzadeh, A., & Date, A. (2017). Performance Evaluation of Solid Desiccant Wheel Regenerated by Waste Heat or Renewable Energy. *Energy Procedia*, 110(December 2016), 434–439. <https://doi.org/10.1016/j.egypro.2017.03.165>
11. Guan, Y., Zhang, Y., Sheng, Y., Kong, X., & Du, S. (2015). Feasibility and economic analysis of solid desiccant wheel used for dehumidification and preheating in blast furnace: A case study of steel plant, Nanjing, China. *Applied Thermal Engineering*, 81, 426–435. <https://doi.org/10.1016/j.applthermaleng.2015.02.006>
12. Guidara, Z., Elleuch, M., & ben Bacha, H. (2013). New solid desiccant solar air conditioning unit in Tunisia: Design and simulation study. *Applied Thermal Engineering*, 58(1–2), 656–663. <https://doi.org/10.1016/j.applthermaleng.2013.05.005>
13. Higashi, T., Yamaguchi, M., Nakagawa, N., Dang, C., & Hihara, E. (2018). Gravimetric method for sorption performance measurement of desiccant wheel and desiccant coated heat exchanger. *Applied Thermal Engineering*, 144, 639–646. <https://doi.org/10.1016/j.applthermaleng.2018.05.079>
14. Intini, M., Goldsworthy, M., White, S., & Joppolo, C. M. (2015). Experimental analysis and numerical modelling of an AQSOA zeolite desiccant wheel. *Applied Thermal Engineering*, 80, 20–30. <https://doi.org/10.1016/j.applthermaleng.2015.01.036>
15. Jani, D. B., Mishra, M., & Sahoo, P. K. (2016a). Experimental investigation on solid desiccant-vapor compression hybrid air-conditioning system in hot and humid weather. *Applied Thermal Engineering*, 104, 556–564. <https://doi.org/10.1016/j.applthermaleng.2016.05.104>
16. Jani, D. B., Mishra, M., & Sahoo, P. K. (2016b). Performance prediction of rotary solid desiccant dehumidifier in hybrid air-conditioning system using artificial neural network. *Applied Thermal Engineering*, 98, 1091–1103. <https://doi.org/10.1016/j.applthermaleng.2015.12.112>
17. Jani, D. B., Mishra, M., & Sahoo, P. K. (2016c). Performance prediction of solid desiccant - Vapor compression hybrid air-conditioning system using artificial neural network. *Energy*, 103, 618–629. <https://doi.org/10.1016/j.energy.2016.03.014>
18. Jani, D. B., Mishra, M., & Sahoo, P. K. (2017). Application of artificial neural network for predicting performance of solid desiccant cooling systems – A review. *Renewable and Sustainable Energy Reviews*, 80(May), 352–366. <https://doi.org/10.1016/j.rser.2017.05.169>
19. Jani, D. B., Mishra, M., & Sahoo, P. K. (2018a). A critical review on application of solar energy as renewable regeneration heat source in solid desiccant – vapor compression hybrid cooling system. *Journal of Building Engineering*, 18, 107–124. <https://doi.org/10.1016/j.job.2018.03.012>
20. Jani, D. B., Mishra, M., & Sahoo, P. K. (2018b). Investigations on effect of operational conditions on performance of solid desiccant based hybrid cooling system in hot and humid climate. *Thermal Science and Engineering Progress*, 7, 76–86. <https://doi.org/10.1016/j.tsep.2018.05.005>

21. Jani, D. B., Mishra, M., & Sahoo, P. K. (2018c). Performance analysis of a solid desiccant assisted hybrid space cooling system using TRNSYS. *Journal of Building Engineering*, 19, 26–35. <https://doi.org/10.1016/j.jobte.2018.04.016>
22. Jiang, Y., Ge, T., & Wang, R. (2013). Performance simulation of a joint solid desiccant heat pump and variable refrigerant flow air conditioning system in EnergyPlus. *Energy and Buildings*, 65, 220–230. <https://doi.org/10.1016/j.enbuild.2013.06.005>
23. Koronaki, I. P., Rogdakis, E., & Kakatsiou, T. (2012). Thermodynamic analysis of an open cycle solid desiccant cooling system using Artificial Neural Network. *Energy Conversion and Management*, 60, 152–160. <https://doi.org/10.1016/j.enconman.2012.01.022>
24. Li, B., Lin, Q. Y., & Yan, Y. Y. (2012). Development of solid desiccant dehumidification using electro-osmosis regeneration method for HVAC application. *Building and Environment*, 48(1), 128–134. <https://doi.org/10.1016/j.buildenv.2011.09.008>
25. Lior, N., & Al-Sharqawi, H. S. (2005). Exergy analysis of flow dehumidification by solid desiccants. *Energy*, 30(6), 915–931. <https://doi.org/10.1016/j.energy.2004.04.029>
26. Merabti, L., Merzouk, M., Kasbadji Merzouk, N., & Taane, W. (2017). Performance study of solar driven solid desiccant cooling system under Algerian coastal climate. *International Journal of Hydrogen Energy*, 42(48), 28997–29005. <https://doi.org/10.1016/j.ijhydene.2017.08.067>
27. Misha, S., Mat, S., Ruslan, M. H., Salleh, E., & Sopian, K. (2015). Performance of a solar assisted solid desiccant dryer for kenaf core fiber drying under low solar radiation. *Solar Energy*, 112, 194–204. <https://doi.org/10.1016/j.solener.2014.11.029>
28. Misha, S., Mat, S., Ruslan, M. H., Salleh, E., & Sopian, K. (2016). Performance of a solar-assisted solid desiccant dryer for oil palm fronds drying. *Solar Energy*, 132, 415–429. <https://doi.org/10.1016/j.solener.2016.03.041>
29. Narayanan, R. (2017). Investigation of Geometry Effects of Channels of a Silica-gel Desiccant Wheel. *Energy Procedia*, 110(December 2016), 20–25. <https://doi.org/10.1016/j.egypro.2017.03.099>
30. Narayanan, R., Saman, W. Y., & White, S. D. (2013). A non-adiabatic desiccant wheel: Modeling and experimental validation. *Applied Thermal Engineering*, 61(2), 178–185. <https://doi.org/10.1016/j.applthermaleng.2013.07.007>
31. Nie, J., Fang, L., Zhang, G., Sheng, Y., Kong, X., Zhang, Y., & Olesen, B. W. (2015). Theoretical study on volatile organic compound removal and energy performance of a novel heat pump assisted solid desiccant cooling system. *Building and Environment*, 85, 233–242. <https://doi.org/10.1016/j.buildenv.2014.11.034>
32. Nóbrega, C. E. L., & Brum, N. C. L. (2012). An analysis of the heat and mass transfer roles in air dehumidification by solid desiccants. *Energy and Buildings*, 50, 251–258. <https://doi.org/10.1016/j.enbuild.2012.03.049>
33. Panaras, G., Mathioulakis, E., & Belessiotis, V. (2007). Achievable working range for solid all-desiccant air-conditioning systems under specific space comfort requirements. *Energy and Buildings*, 39(9), 1055–1060. <https://doi.org/10.1016/j.enbuild.2006.10.015>
34. Panaras, G., Mathioulakis, E., & Belessiotis, V. (2011). Solid desiccant air-conditioning systems - Design parameters. *Energy*, 36(5), 2399–2406. <https://doi.org/10.1016/j.energy.2011.01.022>
35. Qi, R., Tian, C., & Shao, S. (2010). Experimental investigation on possibility of electro-osmotic regeneration for solid desiccant. *Applied Energy*, 87(7), 2266–2272. <https://doi.org/10.1016/j.apenergy.2010.02.005>
36. Qi, R., Tian, C., Shao, S., Tang, M., & Lu, L. (2011). Experimental investigation on performance improvement of electro-osmotic regeneration for solid desiccant. *Applied Energy*, 88(8), 2816–2823. <https://doi.org/10.1016/j.apenergy.2011.01.055>
37. Rajamani, M., Mishra, V. R., & Maliyekkal, S. M. (2017). Bundled-firewood like AlOOH-CaCl<sub>2</sub> nanocomposite desiccant. *Chemical Engineering Journal*, 323(April), 171–179. <https://doi.org/10.1016/j.cej.2017.04.084>

38. Rambhad, K. S., Walke, P. v., & Tidke, D. J. (2016). Solid desiccant dehumidification and regeneration methods - A review. *Renewable and Sustainable Energy Reviews*, 59, 73–83. <https://doi.org/10.1016/j.rser.2015.12.264>
39. Ramzy, A., Abdelmeguid, H., & Elawady, W. M. (2015). A novel approach for enhancing the utilization of solid desiccants in packed bed via intercooling. *Applied Thermal Engineering*, 78, 82–89. <https://doi.org/10.1016/j.applthermaleng.2014.12.035>
40. Tu, R., Hwang, Y., Cao, T., Hou, M., & Xiao, H. (2018). Investigation of adsorption isotherms and rotational speeds for low temperature regeneration of desiccant wheel systems. *International Journal of Refrigeration*, 86, 495–509. <https://doi.org/10.1016/j.ijrefrig.2017.11.008>
41. Tu, R., Hwang, Y., & Ma, F. (2017). Performance analysis of a new heat pump driven multi-stage fresh air handler using solid desiccant plates. *Applied Thermal Engineering*, 117, 553–567. <https://doi.org/10.1016/j.applthermaleng.2017.02.005>
42. Tu, R., Liu, X. H., Hwang, Y., & Ma, F. (2016). Performance analysis of ventilation systems with desiccant wheel cooling based on exergy destruction. *Energy Conversion and Management*, 123, 265–279. <https://doi.org/10.1016/j.enconman.2016.06.013>
43. Tu, R., Liu, X. H., & Jiang, Y. (2013). Performance analysis of a new kind of heat pump-driven outdoor air processor using solid desiccant. *Renewable Energy*, 57, 101–110. <https://doi.org/10.1016/j.renene.2013.01.038>
44. Tu, R., Liu, X. H., & Jiang, Y. (2015). Irreversible processes and performance improvement of desiccant wheel dehumidification and cooling systems using exergy. *Applied Energy*, 145, 331–344. <https://doi.org/10.1016/j.apenergy.2015.02.043>
45. Wang, H. H., Ge, T. S., Zhang, X. L., & Zhao, Y. (2016). Experimental investigation on solar powered self-cooled cooling system based on solid desiccant coated heat exchanger. *Energy*, 96, 176–186. <https://doi.org/10.1016/j.energy.2015.12.067>
46. Zendehboudi, A. (2016). Implementation of GA-LSSVM modelling approach for estimating the performance of solid desiccant wheels. *Energy Conversion and Management*, 127, 245–255. <https://doi.org/10.1016/j.enconman.2016.08.070>
47. Zendehboudi, A., Angrisani, G., & Li, X. (2018). Parametric studies of silica gel and molecular sieve desiccant wheels: Experimental and modeling approaches. *International Communications in Heat and Mass Transfer*, 91, 176–186. <https://doi.org/10.1016/j.icheatmasstransfer.2017.12.002>
48. Zheng, X., Ge, T. S., Jiang, Y., & Wang, R. Z. (2015). Experimental study on silica gel-LiCl composite desiccants for desiccant coated heat exchanger. *International Journal of Refrigeration*, 51, 24–32. <https://doi.org/10.1016/j.ijrefrig.2014.11.015>
49. Zheng, X., Ge, T. S., & Wang, R. Z. (2014). Recent progress on desiccant materials for solid desiccant cooling systems. *Energy*, 74(1), 280–294. <https://doi.org/10.1016/j.energy.2014.07.027>
50. Zheng, X., Wang, R. Z., & Ge, T. S. (2016). Étude Expérimentale Et Prévision Des Performances De Déshydratants Composites À Base De Carbone Pour Les Échangeurs De Chaleur Enrobés De Déshydratant. *International Journal of Refrigeration*, 72, 124–131. <https://doi.org/10.1016/j.ijrefrig.2016.03.013>
51. Zhou, X., Goldsworthy, M., & Sproul, A. (2018). Performance investigation of an internally cooled desiccant wheel. *Applied Energy*, 224(January), 382–397. <https://doi.org/10.1016/j.apenergy.2018.05.011>

## **Invitro Determination of Anti-Aging Activity of (Ananas Comosus L) Using Mccoy Cell Line**

**Abirami J, Sathish Kumar N. M, Hariharan G and Mahalaxmi S**

Department of Biochemistry, Srimad Andavan Arts and Science College (Autonomous), India

### **ABSTRACT**

Aging is a natural phenomenon that affects the entire physiology of an organism. It is the accumulation process of diverse detrimental changes in the cells and tissues with advancing age. The main cause of aging is repeated exposure on UV radiation and excessive formation of free radicals. Today every human being wants to postpone his/her aging and different theories have been given from time to time for aging. Regarding this many products are present in the market, including synthetic as well as a natural molecule. Nowadays it is recommended to highly involved in the anti-aging properties of phytochemicals of natural origin. This is because these phytochemicals have less side effects comparison with synthetic one and are more easily trustable to human beings. Thus, the maintenance of antioxidant homeostasis and the suppression of adipose accumulation are important strategies for anti-aging. Objective of the study to analysis physicochemical, phytochemical and to evaluate in vitro antioxidant properties of ethanolic extracts of Ananas comosus (L.). The present study was efficiently involved in assaying anti-aging activity of Ananas comosus (L.) a member of Bromeliaceae, is a fruit that might have therapeutic properties. Methods: Preliminary phytochemical analysis and quantitative phytochemical analysis for alkaloids, phenol, flavonoids, and saponins were made by following standard procedures. In vitro antioxidant properties were evaluated by assessing 2,2-diphenyl-1-picrylhydrazyl (DPPH); 2,2'azinobis (3ethylbenzothiazoline-6-sulfonic acid) diammonium salt (ABTS) radical scavenging abilities and assaying the reducing power. The results show that highest DPPH radical scavenging activity (60% inhibition) and IC<sub>50</sub> Value 890 µg/ml, the highest ABTS radical scavenging activity (67.1% inhibition) IC<sub>50</sub> Value 400 µg/ml. With increasing concentration (100 to 1000 µg), the reducing power of fruit extracts also increased. correlation of their antioxidant activities with phenolic, flavonoid content in Ananas comosus (L.) fruit extract explains high radical scavenging activity and potential antiaging activity.

Keywords: aging, anti-aging, ananas comosus, physicochemical, phytochemical, Antioxidant.

### **INTRODUCTION**

Aging is a complex process which involves all the layers of the epidermis and dermis. Internal and external factors influence this process. The most important external factor in skin aging is UV radiation, which causes photoaging of the skin. The free radicals that are formed as a result of the UV radiation cause the degradation of unsaturated lipids of the intercellular cement, gaps in the lipid barrier of the skin and changes in the structure of fibrillar proteins—collagen and elastin. The internal factors that cause changes in the skin structure are primarily, physiological disorders in the rate of epidermis exfoliation, inhibition of tissue regeneration, and inhibition of tissue growth and differentiation processes.

### **PREMATURE AGING**

The two distinct types of aging that exist may be due to genetic inheritance implicated in intrinsic (internal) involving cellular senescence and extrinsic (external) aging, such as photoaging. A consequence of both however is the production of free radicals at whose door the blame is laid for the loss of skin elasticity; one of the classical aging characteristics. Skin firmness and elasticity is mainly contributed to by elastin. A dermal protein which is a constituent of the connective tissue (CT).

Over time, the metabolism of the CT proteins slows down accompanied by an increase in enzymatic activity, particularly elastase, which breaks down elastin. One way to prevent such a loss of elasticity is to use active ingredients that are able to inhibit these enzymes and we concentrated on evaluation of the anti-elastase activity. Another molecule of interest is the antioxidant which functions by contributing an additional oxygen molecule to free radicals. In the absence of antioxidants, the free radicals will acquire an oxygen molecule from another biological molecule and this leads to tissue damage and eventually to skin aging. (*Widowati W et al., 2016*)

Aging may be induced by both endogenous factor (reactive oxygen species, H<sub>2</sub>O<sub>2</sub>, Lipid peroxidation) and exogenous factors (alcohol intake, pollution, radiation).

### ANTI-AGING

Anti-aging, which is primarily targeted to replenish new skin cells. Antiaging is the process of slowing down and eventually reversing the effects of aging. Anti-aging can be treated by various herbal products and medicines and are effective in preventing many age-related diseases.

Aging can be prevented by scavenging free radicals. The excessive free radicals like NO can be reduced by escalating antioxidant intake through food or supplements. Many compounds in plants have been identified as free radical or active oxygen scavengers. Furthermore, the other way to retard aging is inhibiting collagenase and elastase activities. As collagenase and elastase increase significantly with age, inhibiting their activities may retard skin aging without interfering their abilities to breakdown damaged skin components. In other words, the use of inhibiting agents helps restore the balance that the skin possessed when it was younger. (Sri Utami *et al.*, 2018)

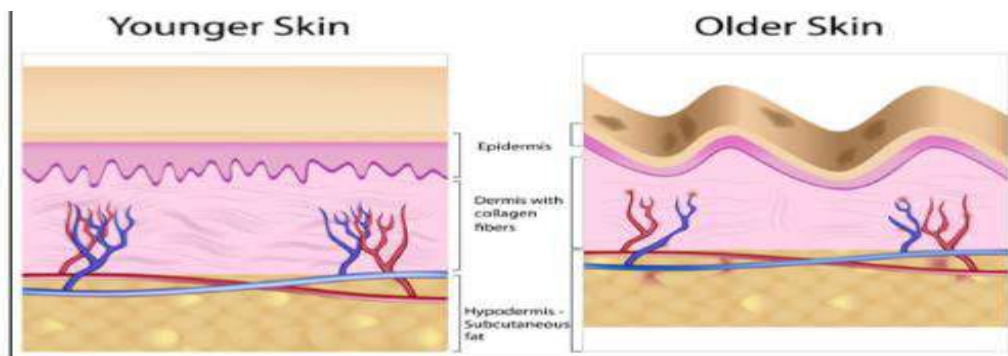


Fig 1: Showing collagen changes during aging

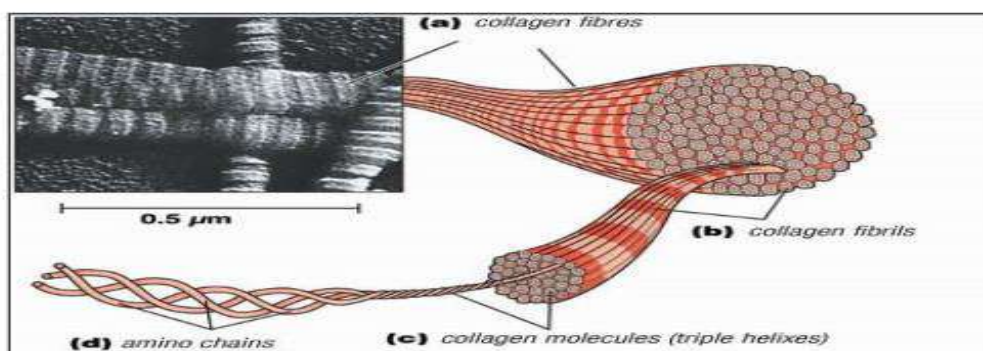
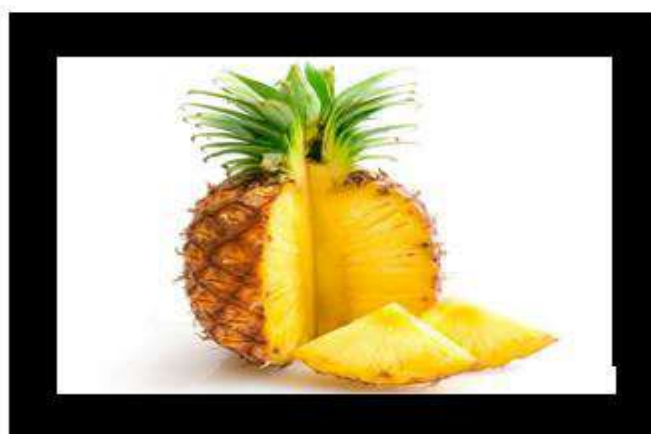


Fig 2: Structure of collagen fibres

Medicinal plants have several phytoconstituents such as polyphenols, alkaloids, tannins, saponins, carotenoids, and terpenoids which possess antioxidant properties and can be used in treating the signs of aging. Some plants contain phenolic compounds which have free-radical scavenging property and can suppress aging. An antiaging agent by neutralizing free radicals, used in the treatment of wrinkles, aging, diabetes mellitus, kidney problems and cancer. The phenolic constituent allylpyrocatechol from the leaves showed activity against obligate oral anaerobes responsible for halitosis and antioxidant activity. (Chanchal Garg *et al.*, 2017)



Ananas comosus protect against the cardiovascular diseases includes disorder of blood vessels, heart attack, stroke, hypertension.

1. It promotes bone growth and strengthens bones due to presence of sufficient amounts of manganese, a mineral considered responsible for healthy bones and connective tissues.
2. Pineapple has been shown to be an effective treatment in upper respiratory tract infections by suppressing coughs and reducing the thickness of mucus.

Pineapple contains bromelain, which is a mix of enzymes can reduce inflammation and nasal swelling, and also aid in the healing of wounds and burns. It's also been linked to helping improve digestion and to treat digestive disorders, reduces the effect of diarrhea.

## **MATERIALS AND METHODS:**

### **COLLECTION OF PLANTS:**

The plant source selected for the study was **Ananas comosus (L.)** is belong to the family Bromeliaceae the fruit were collected in a local market. Fresh juice of pineapple was lyophilized for five days. The lyophilized powder was taken for the antioxidant and antiaging activity.

### **EXTRACTION OF Ananas comosus (L.):**

Twenty grams of lyophilized fruit powder were soaked in 80ml of 95% ethanol in sterilized bottle and kept in fume hood chamber for overnight. The ethanol fraction was separated using sterilized cheesecloth and filtered through sterilized Whatman filter paper (No.3). Filtered the extract into a tarred evaporating dish and evaporated the solvent on a water bath. The residue was dried at 105 °C to constant weight. The percentage of extractive values calculated with reference to the air-dried drug, for ethanol solvent.

### **PHYSICOCHEMICAL PARAMETER**

The determination of various physicochemical parameters such as total ash, acid insoluble ash, water soluble ash, water soluble extractive value, alcohol soluble extractive value and moisture content were calculated as per Indian Pharmacopoeia. (Anonyms., 2001)

#### **Determination of moisture content**

5g of drug (without preliminary drying) was weighed accurately, in a tarred evaporating dish, dried at 105 °C for 5 hours, and weight. The drying and weighing were continued at one hour interval until difference between two successive correspond to not more than 0.25 per cent. When constant weight is reached, the material is cooled for 30 minutes in desiccators. The percentage of moisture content was calculated.

#### **Determination of Total Ash**

2g of accurately weighed plant drug was incinerated in a silica dish at temperature not exceeding 450 °C until free from carbon and weighed. The percentage of ash was calculated with reference to the air-dried drug.

#### **Determination of Acid Insoluble Ash**

The ash obtained from total ash was boiled for 5 minutes with 25 ml of dilute hydrochloric acid. Collected the insoluble matter in an ash less filter paper washed with hot water and ignited to constant weight. The percentage of ash was calculated with reference to the air-dried drug.

#### **Determination of Water-Soluble Ash**

The ash obtained from total ash was boiled for 5 minutes with 25 ml of distilled water. The insoluble matter was collected in an ash less filter paper, washed with hot water and ignited for 15 minutes at a temperature not exceeding 450 °C. The weight of the insoluble matter subtracted from the weight of the ash, the difference in weight represents the water-soluble ash. The percentage of water-soluble ash with reference to the air-dried drug was calculated. (Chase CR *et al.*, 1949)

### **FLUORESCENCE ANALYSIS**

Fluorescence analysis of the drug was observed under Day and UV light for 24 and 48 hours using various solvent extracts as well as treating with acids and alkaline solutions of the drug. The powder was treated with neutral solvents like Hexane, Benzene, Chloroform, Ethyl acetate, Alcohol, Acetone and acids like 1N Hydrochloric acid, 50% Sulphuric acid and alkaline solutions like aqueous and alcoholic 1N NaOH. (Brindha P *et al.*, 1981)

### **DETERMINATION OF EXTRACTIVE VALUES**

2g of the air-dried plant drug macerated with 100 ml various solvent in the order of increasing polarity (Hexane, Chloroform, Water, Alcohol, Ethyl acetate, methanol) in a closed flask for 24 hrs frequently shaken during first 6 hrs and allowed to stand for 18 hrs. Rapidly filtered taking precautions against loss of solvent. Evaporated 25 ml of filtrate to dryness in tarred flat-bottomed china dish and dried at 105°C until constant weight is obtained. The percentage of soluble extractive calculated with reference to the air-dried drug.

### **PRELIMINARY PHYTOCHEMICAL SCREENING OF PLANT POWDER**

Preliminary phytochemical screenings of various extracts and drug powder were carried out as per the standard textual procedure. (Prashant Tiwari, *et al.*, 2011)

#### **Test for Saponins:**

The substance was shaken well with water.

#### **Test for Tannins:**

The substance was mixed with basic lead acetate solution.

#### **Test for Steroids (Liebermann burchard test)**

The sample was taken in a test tube added few drops of glacial acetic acid, acetic anhydride and 1ml of concentrated Sulphuric acid was added along the sides of the test tube.

#### **Test for Terpenoids (Salkowshi test)**

The substance was warmed with tin and thionyl chloride.

#### **Test for Flavonoids (Shinado's test)**

To the substance added alcohol, few magnesium turnings and few drops of concentrated hydrochloric acid and boiled for 5 minutes.

#### **Test for Coumarin**

A small quantity of substance was mixed with few drops of 10% sodium hydroxide.

#### **Test for Quinones**

The substance was mixed with few drops of concentrated sulphuric acid.

#### **Test for Lignins**

The substance was mixed with Alcoholic solution of Phloroglucinol and added few drops of concentrated Hydrochloric acid.

#### **Test for Alkaloid**

To the substance few drops of acetic acid was added, followed by Dragendroff's reagent and shaken well.

#### **Test for Sugars**

The substance was mixed with anthrone and 1 drop of concentrated Sulphuric acid and warmed gently.

#### **Test for Phenol**

The substance was mixed with sodium carbonate and folins phenol solution.

- Quantitative Estimation Of Major Secondary

Metabolite

- Estimation of Phenol (Malick Cp *Et Al.*, 2008)

Estimation of Total Alkaloids (Fergusn Nm, 1956)

Estimation of Saponins (Hiai S *Et Al.*, 1976)

Estimation of Total Flavonoids (Suman Chandra *Et Al.*, 2014)

- Quantitative Estimation Of Primary Metabolites

Estimation of Carbohydrate (Sathasivam And Manickam., 1992)

Estimation of Protein (Lowry *Et Al.*, 1951)

Determination of Crude Fat (Arlington Va *Et Al.*, 1993)

- Antioxidant Assay:

1. DPPH radical scavenging assay (Brand williams *et al.*, 1995)
2. ABTS radical scavenging Assay (Jain.P.K *et al.*,2008)
3. REDUCING POWER ASSAY (Manmohan Sngal *et al.*, 2011)
4. COLLAGENASE INHIBITION ASSAY
5. MTT Assay

## RESULT AND DISCUSSION

**Table - 1** Physicochemical Constant Of *Ananas Comosus* (L.)

S/NO	PARAMETER	VALUES (%)
1.	Moisture content	17.3
2.	Total ash	15.8
3.	Water soluble ash	6.21
4.	Acid insoluble ash	2.42
5.	Loss on dry	9.25

From the **Table 1** it was found that the ash content of the fruit material was 15.8 % and acid insoluble ash was found to be 2.42 %, which indicated the purity of the test drug taken under study.

### LOSS ON DRYING:

The presence of active chemical metabolites and its decomposition on storage dry powder of plant materials is based on its moisture content during storage condition. The low value of loss on drying of dry powder of *Ananas comosus* (L.) showed its proper storage and further indicated that the fruit powder does not have any foreign particles.

### ASH VALUE:

Ash value aids to decide quality and purity of crude drugs. Total ash, acid insoluble ash and water-soluble ash % were determined. The results showed that there is a higher value of total ash and lesser acid insoluble ash indicates the purity. (Kokate *et al.*,2002)

**Table – 2** Extractive Value of *Ananas Comosus* (L.)

EXTRACTIVE SOLVENTS	VALUES (%)
Hexane	0.65
Chloroform	1.9
Methanol	40.5
Ethyl acetate	5.45
Ethanol	50.5
Water	30.6

**Table 2** depicted that ethanol extractive value is significantly more when compared to other extractives, indicates the presence of high polar compounds in selected drug (Anonymous 2002) the hexane and chloroform extractive values were 0.65 % and 1.9 % respectively, which indicated the presence of low polar compounds such as Flavones and phenols.

**Table – 3** Fluorescent Analysis Of *Ananas Comosus* (L.)

S.No	Treatment	<i>Ananas comosus</i> (L.)					
		Day light (0 hrs)	UV light (0 hrs)	Day light (24 hrs)	UV light (24 hrs)	Day Light (48 hrs)	UV light (48 hrs)
1	Drug powder	Green	Black	Green	Light green	Green	Black
2	Drug powder+aq. 1 N NaOH	Yellow	Light Green	Light brown	Dark green	Brown	Light green
3	Drug powder+alc. 1 N NaOH	White	Light Green	yellow	Yellowish Green	Yellow	Brown
4	Drug powder+1 N Hcl	Brown	Light Green	Dark green	Light green	Green	Dark green
5	Drug powder+ 50% H <sub>2</sub> SO <sub>4</sub>	Light Brown	Light green	Light brown	Brown	Brown	Light green



6	Drug powder+chloroform	Pale yellow	Light Green	Yellow	Light orange	Yellow	Orange
7	Drug powder+Hexane	White	Light green	Light yellow	Light orange	Light yellow	Light orange
8	Drug powder+Ethyl acetate	White	Orange	Dark green	Orange	Dark green	Light orange
9	Drug powder+acetone	Pale yellow	Orange	Light green	Orange	Green	Orange
10	Drug powder+Benzene	Pale yellow	Yellow	Light yellow	Orange	Light green	Orange
11	Drug powder+alcohol	Light Green	Light green	Dark green	Light green	Green	Light orange
12	Drug powder+water	White	Dark green	Yellowish brown	Light green	Yellowish brown	Light green

**Table 3** depicted the fluorescence analysis of the drug powder. The fluorescence behavior of the drug powder with the above-mentioned chemicals was observed in the daylight and UV light, which was found to give various shades of green, brown, and yellow.

The brown and yellow fluorescence indicates the presence of Alkaloids and Flavonoids. The green fluorescence indicates the presence of sterols.

Crude drugs are often assessed qualitatively for their fluorescence features and it is an important parameter to evaluate the nature of chemical constituents present in the fruit.

**Table -4** Preliminary Phytochemistry Of *Ananas Comosus* (L.)

S. No	Test	Dry Powder	Ethanollic Extract
1	Saponin	+	+
2	Tannin	+	+
3	Sterol	-	-
4	Terpene	+	+
5	Flavonoid	+	+
6	Coumarin	+	+
7	Quinone	+	+
8	Lignin	-	-
9	Alkaloid	+	+
10	Glycosides	-	-
11	Sugar	+	+
12	Phenols	+	+

**Note: (-) Absence, (+) Presence**

The preliminary phytochemical screening of the test drug was tabulated (**Table 4**), which revealed the presence of Saponin, Tannin, Quinone, Coumarin, terpene, alkaloid, flavonoids, sugar, and Phenol. and the absence of sterol, glycosides, Lignin.

The preliminary phytochemical screening of ethanolic extracts of the drug powder *Ananas comosus* (L.) revealed the presence of saponin, tannin, terpene, quinone, coumarin, alkaloid, flavonoids, sugar, phenols.

**Table – 5** Quantitative Analysis of Major Secondary Metabolites of *Ananas Comosus* (L.)

SECONDARY METABOLITES	mg/g
Phenols	3.9
Alkaloids	2.17
Saponins	18
Flavonoids	12

Quantitative estimation of important metabolites was carried out and the results were tabulated in **Table 5**. The saponin of *Ananas comosus* (L.) content was found to be higher when compared to Flavonoids and phenol. The fruit drug also contains a moderate amount of Alkaloid.

The high amount of Saponin content may attribute to the pharmacological activity of the fruit drug taken under study. (Histogram 1).

**Table – 6** Quantitative Analysis of Primary Metabolites of *Ananas Comosus* (L.)

S/NO	PRIMARY METABOLITES	mg/g
1	Carbohydrates	0.9
2	Proteins	36.8
3	Crude fat (%)	3.37

The results of the quantitative analysis of organic compounds of the test drug powder were tabulated in **Table 6**.

#### IN VITRO ANTIOXIDANTS

**Table 7 -** Effect of *Ananas Comosus* (L.) On Dpph Scavenging Activity:

S. No	CONCENTRATION (µg/ml)	SCAVENGING OF DPPH FREE RADICAL (%)	IC <sub>50</sub> VALUE (µg/ml)
1	100	10.81	890
2	200	12.85	
3	300	18.16	
4	400	21.59	
5	500	23.6	
6	600	27.2	
7	700	34.4	
8	800	40.6	
9	900	52	
10	1000	60	
11	Ascorbic acid	21.2	

The percentage scavenging of DPPH free radical was calculated and the percentage inhibitions were tabulated in **Table 7**.

The result depicts the increased antioxidant effect on DPPH (Diphenyl-2-picrylhydrazyl) with an increase in the concentration of the test drug (100 – 1000 µg/ml). The result was comparable with that of standard ascorbic acid. The maximum percentage inhibition of DPPH radical was 60% at a concentration of 1000 µg/ml. The percentage of inhibition of DPPH is strongly dependent on the concentration of fruit extract (Amin & Tan 2002). The mean IC<sub>50</sub> value of fruit extract was found to be 890 µg/ml.

DPPH is a relatively stable free radical and the assay determines the ability of ethanol extracts of *Ananas comosus* (L.) to reduce DPPH radical to the corresponding hydrazine by converting the unpaired electrons to paired ones. Various concentration of ethanolic extract of fruit was allowed to react with stable DPPH radicals and its antioxidant potentials were determined by a decrease in its absorbance at 517 nm. The free radicals in DPPH can be neutralized by the antioxidants present in fruit extract by transferring either electron or by hydrogen atoms to DPPH thereby changing the color from purple to yellow colored diphenyl picrylhydrazine (Naik et al.,2003). The concentration of antioxidants needed to decrease the initial DPPH concentration by 50 % is known as the IC<sub>50</sub> value. The lower concentration of fruit for IC<sub>50</sub> indicates higher antioxidant activity (Kazimeriz et al.,1997). Both the fruit extract and standard ascorbic acid demonstrated strong DPPH scavenging properties in a concentration-related manner. The presence of polyphenolics compounds could be responsible for this observation (Adedapo et al.,2008).

**Table 8 -** Effect Of *Ananas Comosus* (L.) On Abts Scavenging Activity:

S. No	CONCENTRATION (µg/ml)	SCAVENGING OF ABTS FREE RADICAL (%)	IC <sub>50</sub> VALUE (µg/ml)
1	100	24.3	400
2	200	34.2	
3	300	42.1	
4	400	50.3	
5	500	67.1	
6	Ascorbic acid	49.3	

The percentage scavenging of ABTS free radical was calculated and the percentage inhibitions were tabulated in **Table 8**.

The result depicts the increased antioxidant effect on ABTS (2, 2-azinobis-3-ethyl-benzothiozoline-6-sulphonic acid) with increase in concentration of the test drug (**100 – 500 µg/ml**). The result was comparable with that of standard ascorbic acid. The maximum percentage inhibition of ABTS radical was **67.1%** at a concentration of **500 µg/ml**. The percentage of inhibition of ABTS strongly dependent on concentration of fruit extract (**Amin & Tan 2002**). The mean IC<sub>50</sub> value of fruit was found to be **400 µg/ml**.

An antioxidant with an ability to donate a hydrogen atom will quench the stable free radical: a process which is associated with a change in absorption can be followed by spectrophotometrically. The relatively stable ABTS radical has a green color and is quantified spectrophotometrically at 734 nm. (**R.K. Agrawal et al., 2018**)

**Table 9 - Effect Of Ananas Comosus (L.) On Reducing Power Activity:**

S. No	CONCENTRATION (µg/ml)	FRAP SCAVENGING ACTIVITY (%)	IC <sub>50</sub> VALUE (µg/ml)
1	100	33.3	<b>160</b>
2	200	60	
3	300	71.4	
4	400	77.7	
5	500	81.8	
6	600	84.6	
7	700	86.5	
8	800	88.2	
9	900	88.8	
10	1000	90	

The percentage of reducing power activity was calculated and the percentage of reducing power activity were tabulated in **Table 9**.

The Reducing power of fruit extract as increased with increasing concentration of the test drug (**100-1000 µg/ml**). (**Table -9**) The result was comparable with that of standard ascorbic acid. The percentage inhibition of reducing power was recorded maximum of **90%** at concentration of **1000 µg/ml**. The percentage inhibition of reducing power strongly dependent on concentration of fruit extract. The mean IC<sub>50</sub> value of fruit found to be **160 µg/ml**. Ethanolic extract of fruit showed high reducing power potential and followed by dose dependent increase in the reducing power activity.

Fe (III) reduction is often used as an indicator of electron donating activity. Which is an important mechanism of antioxidant activity. In the reducing assay. The presence of antioxidant in the test drug resulted in the reduction of Fe<sup>3+</sup> to Fe<sup>2+</sup> by donating electron. Amount of Fe<sup>2+</sup> complex can be measured at 700 nm. Increasing absorbance indicated an increase in reductive ability.

The ethanolic extract seems to have good reducing power that was comparable with standard ascorbic acid.

The reducing capacity of a compound serves as an important indicator of its potential antioxidant activity. (**Meir et al., 1995**)

**Table 10 - Effect of Ananas Comosus (L.) On Collagenase Inhibition Activity:**

S. No	CONCENTRATION (µg/ml)	INHIBITION OF COLLAGENASE (%)	IC <sub>50</sub> VALUE (µg/ml)
1	100	6.7	<b>480</b>
2	200	18.6	
3	300	27.8	
4	400	39.6	
5	500	52.6	

The percentage inhibition of collagenase was calculated and the percentage inhibitions were tabulated in **Table 10**.

Collagenase inhibition of fruit extract shows increased with increasing concentration of the test drug (**100 – 500 µg/ml**). (**Table 10**). The percentage of collagenase inhibition was recorded maximum of **52.6 %** at a concentration of **500 µg/ml**. The percentage of collagenase inhibition is strongly dependent on the

concentration of fruit extract. The mean  $IC_{50}$  value of fruit was found to be **480  $\mu\text{g/ml}$** . ethanolic extract of fruit showed high collagenase inhibition potential by dose-dependent.

**Table 11** – Cytotoxicity Effect of *Ananas Comosus* (L.) On Mccoy Cell Line

S.No	CONCENTRATION ( $\mu\text{g/ml}$ )	(%) OF DEATH CELLS
1	6.25	0.7
2	12.5	2.0
3	25	2.6
4	50	3.6
5	100	4.5

MTT assay is based on the respiratory ability of the mitochondrial succinate tetrazolium reductase system, which converts the yellow tetrazolium salt to purple formazan dye. The “succinate-tetrazolium reductase” system belongs to the respiratory chain of the mitochondrial and is active only in viable cells. The amount of formazan produced by the dehydrogenase enzyme was directly proportional to the number of living cells in the culture. an increase in cell number results in an increase in the amount of MTT formazan formed and an increase in absorbance.

The ability of the cells to survive a toxic insult has been the basis of most cytotoxicity assays. It depends both on the number of viable cells and on the mitochondrial activity of cells. 3-(4,5-dimethylthiazol-2-yl)-2,5-diphenyltetrazolium bromide (MTT) assay is based on the assumption that dead cells or their products do not reduce tetrazolium. Tetrazolium salts are reduced only by metabolically active cells. The MTT can be reduced to purple-colored formazan by the mitochondrial succinate dehydrogenase enzyme. The amount of formazan produced is directly proportional to the number of active cells (Asokan and Thangavelu, 2014).

The present study was subjected to an MTT assay to evaluate its anticytotoxicity nature using the McCoy cell line. McCoy cells showed mild cytotoxicity with the increase in concentration. The ethanol extract of *Ananas comosus* (L.) did not confer any significance to healthy cell lines, McCoy cell line confirming the safe nature of the extract.

#### SUMMARY AND CONCLUSION

Aging is caused by both intrinsic damage due to chronological aging, and extrinsic damage such as dryness, sunlight, smoking, and environmental pollution. With respect to extrinsic damage, the effect of ultraviolet (UV) irradiation is well known and generally referred to as photo-aging. UV irradiation leads to DNA damage and induces oxidative stress by the production of reactive oxygen species (ROS). These pathways increase the synthesis and activity of proteases that degrade the extracellular matrix (ECM), which comprises collagen and elastin fibers (Takeuchi *et al* 2010). During this process, ROS generation is increased which leads to mitochondrial damage in the cell. It was postulated that lifespan is determined by the rate of free radical damage to the mitochondria. *Ananas comosus* (L.), a member of the family *Bromeliaceae* is an important medicinal fruit.

The fruit is used in folk medicine to treat antiaging, diabetes mellitus, anti-bacterial, anti-inflammatory, analgesic, anti-diarrheal, anti-cancerous, nephroprotective, antimicrobial, antioxidant, and thyroid regulating activity. As per the ethnobotanical literature on traditional phytotherapy of Indian medicinal fruit, the species *Ananas comosus* (L.) is consistently used to prevent antiaging. There is not much scientific evidence available for this plant to treat antiaging.

The preliminary phytochemical screening of drug powder *Ananas comosus* (L.) was tabulated which revealed the presence of Saponin, Tannin, Quinone, Coumarin, terpene, alkaloid, flavonoids, sugar, and Phenol. and the absence of sterol, glycosides, Lignin.

These high amounts of carbohydrates in the fruit investigated confer on them, significant roles to human health. This is because, apart from the supply of energy, carbohydrates are also needed in numerous biochemical reactions not directly concerned with energy metabolism. The level of protein in the fruit is the only minimal amount of the protein contents of fruit studied, indicating that its intake can contribute to the formation of hormones that controls a variety of body functions such as growth, repair, and maintenance (replacement of wear and tear of tissues) of body.

Crude fiber is increasingly being recognized as a useful tool for the control of the oxidative process in food products and as a functional food ingredient. The presence of crude fiber in the diet is necessary for digestion

and for the elimination of wastes. The contraction of muscular walls of the digestive tract is stimulated by fiber, thus counteracting constipation.

The effect of excess intake of crude fat has some well-established health implications, especially for the overweight. The consumption of excess amounts of fats has been recognized as the most important dietary factor aiding increased levels of cholesterol. Besides the cholesterol implications due to high fat intake, obesity is a factor in the causation of disease.

Quantitative analysis of various secondary metabolites shows high phenol content. The increase in the total phenolic content of the ethanolic extracts shows higher antioxidant activities as it is well known that fruit phenolics, in general, are highly effective free radical scavengers and antioxidants (Rathee *et al.*, 2006). *Ananas comosus (L.)*. fruit ethanolic extract shows better scavenging effects on DPPH, ABTS and also higher reducing power.

The result suggests that the ethanolic extract of *Ananas comosus (L.)*. exhibits a significant antioxidant potential which is proved by the techniques such as the DPPH scavenging assay method, ABTS scavenging assay method, and reducing power assay. So, the fruit extract is a potent source of natural antioxidants, which might be helpful in preventing the progress of various oxidative stresses. They may result in a new antiaging drug with less toxicity. So, ethanolic extract of the fruit of *Ananas comosus (L.)*. may be potentially useful in controlling the excessive formation of free radicals. MTT assay shows mild cytotoxicity on the increasing concentration of fruit extract. The ethanolic extract of *Ananas comosus (L.)*. did not confer any significance to healthy cell lines, McCoy cell line confirming the safe nature of the extract. This study provides scientific evidence of their anti-aging effect. These plants are very affordable to the common man and can be easily incorporated into their daily diets. They can be further analyzed to develop antiaging drugs free from harmful side effects.

## REFERENCES

1. Sri Utami, Qomariyah Romadhiyani Sachrowardi, Ndaru Andri Damayanti, Arroyan Wardhana, Irfan Syarif, Said Nafik, Betharie Cendera Arrahmani, et al., Antioxidants, anti-collagenase and antielastase potentials of ethanolic extract of ripe sesoot (*Garcinia mycorrhiza* Miq.) fruit as antiaging. *J Herbmed Pharmacol*, 2018; 7(2): 88-93.
2. Chanchal Garg, Priyanka Khurana, Munish Garg. Molecular mechanisms of skin photoaging and plant inhibitors. *International Journal of Green Pharmacy*, Apr-Jun 2017; 11 (2):S217.
3. Rebeca M Lima, Hudson C Polonini, Marcos AF Brandão, Francisco J Raposo, et al., In vitro Assessment of Anti-aging Properties of *Syzygium cumini* (L.) Leaves Extract. *Biomedical Journal of Scientific & Technical Research*, 2019; 13(4).
4. Satardekar K.V and Deodhar M.A. Anti-Ageing Ability of Terminalia Species with Special Reference to Hyaluronidase, Elastase Inhibition and Collagen Synthesis In Vitro. *International Journal of Pharmacognosy and Phytochemical Research*, 2010; 2(3):30-34.
5. Mahendra Kumar Trivedi, Alice Branton, Dahryn Trivedi, Gopal Nayak, et al., Estimation of Collagen Synthesis in Human Dermal Fibroblast Cells: an Impact of Consciousness Energy Healing Treatment. *International Journal of Research Studies in Medical and Health Sciences*, 2018; 3(9) :18-24.
6. Figueiredo Filho D.A., Faria F.S.E.D.V., Rodriguez A.F.R., Vale P.A.A., et al., Mulateiro (*Calycophyllum spruceanum*) Stem Cell Extract: An Evaluation of Its Anti-Aging Effect on Human Adult Fibroblasts. *International Journal of Scientific & Engineering Research*, 2016; 7(11):87-90.
7. Induja Kalyana Sundaram, Deepika Deeptirekha Sarangi, Vignesh Sundararajan, et al., Poly herbal formulation with anti-elastase and anti-oxidant properties for skin antiaging. *BMC Complementary and Alternative Medicine*, 2018; 18:33.
8. Chul Ho Kang, Sung Ja Rhie and Young Chul Kim. Antioxidant and Skin Anti-Aging Effects of Marigold Methanol Extract. *Toxicol. Res*, 2018; 34(1):31-39.
9. Myung-Soo Shon, Yunjeong Lee, Ji-Hye Song, Taehyun Park, et al., Anti-aging Potential of Extracts Prepared from Fruits and Medicinal Herbs Cultivated in the Gyeongnam Area of Korea. *Prev. Nutr. Food Sci*, 2014;19(3):178-186.

10. Caroline Mathen, Renuka Thergaonkar, Moushami Teredesai, Gaurav Soman and Shiney Peter. Evaluation of anti-elastase and antioxidant activity in antiaging formulations containing terminalia extracts. *International Journal of Herbal Medicine*, 2014; 2 (2): 95-9.
11. Supachai Yodkeeree, Pilaiporn Thippaphana, Wanisa Punfaa, Jatupol Srisomboon, et al., Skin Anti-aging Assays of Proanthocyanidin Rich Red Rice Extract, Oryzanol and Other Phenolic Compounds. *Natural Product Communications*, 2018; 13 (8): 967 -972.
12. Aranya Manosroi, Pensak Jantrawut, Toshihiro Akihisa, Worapaka Manosroi & Jiradej Manosroi, et al., In vitro anti-aging activities of Terminalia chebula gall extract. *pharmaceutical biology*, 2010; 48(4): 469-481.
13. Pham Thi Be Tu and Shinkichi Tawata. Anti-Oxidant, Anti-Aging, and Anti-Melanogenic Properties of the Essential Oils from Two Varieties of Alpinia zerumbet. *Molecules*, 2015; 20: 16723-16740.
14. Vaibhav Rajan Parulkar, Mahendra Kumar Trivedi, Alice Branton, et al., The Use of Consciousness Energy Healing Based Herbomineral Formulation for Skin Anti-Aging Strategies. *Journal of Food and Nutrition Sciences*, 2017; 5(3): 96-106.
15. Ha Youn Lee, Amal Kumar Ghimeray, Jun-Hwan Yim, Moon Sik Chang. Antioxidant, Collagen Synthesis Activity in Vitro and Clinical Test on Anti-Wrinkle Activity of Formulated Cream Containing Veronica officinalis Extract. *Journal of Cosmetics, Dermatological Sciences, and Applications*, 2015; 5: 45-51.
16. Deepak Adhikari, Vijay Kumar Panthi, Rudra Pangani, et al., Preparation, Characterization, and Biological Activities of Topical Anti-Aging Ingredients in a Citrus Junos Callus Extract. *Molecules*, 2017; 22: 2198.
17. Laeli Muntafiah, Bani Adelina Shabrina, Dwi Sulistyowati, Murah Riski Novi Asshagab, et al., Anti-Aging Activity of Cucurbita moschata Ethanolic Extract Towards NIH3T3 Fibroblast Cells Induced by Doxorubicin. *Indonesian Journal of Cancer Chemoprevention*, 2016; 7(2): 49-53.
18. Juliana Carvalhães Lago and Maria Beatriz Puzzi. The effect of aging in primary human dermal fibroblasts. *Journal.pone*, 2019;14(7).
19. Seeun Jeon and Mina Choi. Anti-inflammatory and anti-aging effects of hydroxytyrosol on human dermal fibroblasts (HDFs). *Jeon and Choi Biomedical Dermatology*, 2018; 2:21.
20. Hyunji lee, Youngeun hong, so hee Kwon, et al., Anti-aging effects of Piper cambodianum P. Fourn. extract on normal human dermal fibroblast cells and a wound-healing model in mice. *Clinical Interventions in Aging*, 2016; 11: 1017–1026.
21. Ji Hoon Ha, A Rang Kim, Keon-Soo Lee, Song Hua Xuan, Hee Cheol Kang, Dong-Hwan Lee, Mi Yeon Cha, et al., Anti-Aging Activity of Lavandula angustifolia Extract Fermented with Pediococcus pentosaceus DK1 Isolated from Diospyros kaki Fruit in UVB-Irradiated Human Skin Fibroblasts and Analysis of Principal Components. *J. Microbiol. Biotechnol*, 2019; 29(1): 21–29.
22. Mahendra Kumar Trivedi and Snehasis Jana. Evaluation of Anti-Aging Activity of the Biofield Energy Treated Novel Test Formulation Using SIRT1 and Telomerase Activity in in Vitro Model. *Journal of Ageing Research and Healthcare*, 2019; 2(4): 21-29.
23. Sunil Kumar Shah, Gopal Garg, Deenanath Jhade and Narendra Patel. Piper Betle: Phytochemical, Pharmacological and Nutritional Value in Health Management. *Int. J. Pharm. Sci. Rev. Res.*, 2016; 38(2): 181-189.
24. D. Pradhan, Dr. K. A. Suri, Dr. D. K. Pradhan and P. Biswasroy. Golden Heart of the Nature: Piper betle L. *Journal of Pharmacognosy and Phytochemistry*, 2013; 1 (6): 147-167.
25. Vandana Dwivedi and Shalini Tripathi. Review study on potential activity of Piper betle . *Journal of Pharmacognosy and Phytochemistry*, 2014; 3(4): 93-98.
26. Syahidah, C.R. Saad, M.D. Hassan, Y. Rukayadi, M.H. Norazian and M.S. Kamarudin. Phytochemical Analysis, Identification and Quantification of Antibacterial Active Compounds in Betel Leaves, Piper betle Methanolic Extract. *Pakistan Journal of Biological Sciences*, 2017; 20 (2): 70-81.
27. M Mahfuzul Hoque, Shemona Rattila, M Asaduzzaman Shishir, M L Bari, Y Inatsu, and S Kawamoto. Antibacterial Activity of Ethanol Extract of Betel Leaf (Piper betle L.) Against Some Food Borne Pathogens. *Bangladesh J Microbiol*, 2011; 28( 2): 58-63.

28. Anonyms, “ The Ayurvedic pharmacopeia of Government of India, Ministry of Healths and Family Welfare, Department of medicine Indian system of medicine and Homeopathy, New Delhi, 2001. (1) 142-143.
29. Chase CR and Pratt RJ, *Am. Pharm Ass Sci. Ed*, 1949. 38:324.
30. Brindha P, Sasikala and Bhimarao, “Pharmacognostic studies on Coleus Aromatic Benth”, *Indian Berage, B.M.E.B.R*, 1981; 12: 17-31.
31. Prashant Tiwari\*, Bimlesh Kumar, Mandeep Kaur, Gurpreet Kaur, Harleen Kaur., *Phytochemical screening and Extraction: A Review.*, *Internationale Pharmaceutica Scientia* ., 2011 ; Vol 1 Issue 1.
32. Malick CP and Singh MB, “Estimation of Phenols”, *Int Plant Enzymology and Histo enzymology*, New Delhi, 2008. 286.
33. Fergusn NM, *A Textbook of Pharmacognosy*, New Delhi, 1956. P-191
34. Hiai, S., Oura, H., Nakajima, T., *Color reaction of some saponin and saponins with vanillin and sulfuric acid. Planta Medica* 1976; 29, 116 – 122.
35. Suman Chandra, Shabana Khan, Bharathi Avula, Hemant Iata, Mahmoud A. ElSoholy and Ikhlas A. Khan., *Assessment of Total phenolic content and Flavonoid content, Antioxidant properties, and yield of Aeroponically and Conventionally Grown Leafy Vegetables and Fruit crops: A Comparative study.* 2014
36. Sadhasivam S, Manikam A., *Biochemical methods for Agricultural science.* Wiley Eastern Limited, New Delhi, 1992: PP. 6-7;11-12.
37. Lowry, O.H., Rosebrough, N.J., Farr, A.L., and Randall, R.J. *Protein measurement with the Folin Phenol reagent. J.Bio. Chem.* 193, 265-275.
38. Carpenter, D.E., J. Ngeh-Ngwainbi, and S.C. Lee, *Lipid Analysis, in Methods of Analysis for Nutrition Labiling*, edited by D.M.Sullivan and D.E Carpenter, AOAC, Inc., Arlington, VA, 1993, pp.85-104.
39. Marian Draganov, Marianna Murdjeva and Teodora Michailova-Topalska. McCoy and McCoy-plovdiv cell lines in experimental and diagnostic practice – past, present and perspectives. *Journal of Culture Collections*, 2004-2005;4(1):3-16.
40. Brand-Williams W, Cuvelier ME, Berset C., *Use of a free radical’s method to evaluate antioxidant activity. Food Sci Technol* 1995;28:25-30.
41. P.K. Jain and R.K. Agrawal *Antioxidant and Free Radical Scavenging Properties of Developed Mono- and Polyherbal Formulations. Asian J. Exp. Sci.*, Vol. 22, No. 3, 213-220 ;2018
42. Manmohan Singhal, Arindam Paul, Hemendra P. Singh, *Synthesis and reducing power assay of methyl semicarbazone derivatives.* 2011.
43. Meena VS, Meena SK, Verma JP, Meena RS, Ghosh BN., *The needs of nutrient use efficiency for sustainable agriculture.*, *J Clean Prod* 102;562-563.
44. Anonymous. *Quality control methods for Medicinal Plant Materials [An authorized publication of World Health Organization, Geneva]* New Delhi; A.I.T.B.S. Publishers and distributors (Regd.).2002.
45. Kokate CK, Purohit AP, Gokhale SB. *Pharmacognosy.* Nirali prakashan; 38th Edition, Pune; 2008.
46. Amin I, Tan SH. “Antioxidant Activity of Selected Commercial Seaweeds”. *Mal. J. Nutr.* 2002; 8(2): 167-177.
47. Naik GH, Priyadarsini KI, Satav JG, Banavalikar MM, Sohoni DP, Biyani MK. “Comparative antioxidant activity of individual herbal components used in Ayurvedic medicine”. *Phytochem.* 2003; 63: 97–104.
48. Kazimierz G, Katarzyna S, Barbara B, Beata K, Magda J, Jan O. “Antimutagenic activity of anthocyanins isolated from Aronia melanocarpa fruits. *Cancer Letters.* 1997; 119:37-46.
49. Adedapo, A.A., F.O. Jomoh, A.J. Afolayan and P.J. Masika, 2008. “Antioxidant activities and phenolics contents of the methanol extracts of the stem of *Acokanthera oppositifolia* and *Adenia gummifera*. *J. BMC Compl. Alt. Med.*, 8: 54 – 54.

50. Meir, SJ. Kanner, B. Akiri, and S. P. Hadas. 1995. "Determination and involvement of aqueous reducing compounds in oxidative defense systems of various senescing leaves". *J. Agric. Food Chem.* 43: 1813-1817.
51. Takeuchi, H.; Gomi, T.; Shishido, M.; Watanabe, H.; Suenobu, N. Neutrophil elastase contributes to extracellular matrix damage induced by chronic low-dose UV irradiation in a hairless mouse photoaging model. *J. Dermatol. Sci.* 2010, 60, 151–158.
52. Rathee JS, Patro BS, Mula S, Gamre S and Chattopadhyay S. Antioxidant activity of Piper betel leaf extract and its constituents. *Journal of Agricultural and Food Chemistry*, 54: 2006; 9046-9054



---

---

## **A Study of the Awareness and Impact of Organic Food within Generations (X & Y)**

**Girish Deore<sup>1</sup> and Seema Zagade<sup>2</sup>**

<sup>1</sup>Dr. D.Y. Patil Institute of Hotel Management and Catering Technology, Pune, India

<sup>2</sup>Savitribai Phule Pune University (Formerly Pune University), India

<sup>2</sup>Maharashtra State Institute of Hotel Management and Catering Technology, Pune, India

### **ABSTRACT**

The goal of this study is to discover the differences in organic food awareness and attitudes between the X and Y generations. Questionnaires were utilized to collect data, which were assessed using closed-ended questions and a 5-point Likert scale. According to the findings of this study, there is no substantial difference between the X and Y generations in terms of organic food awareness and the factors that influence organic food purchasing decisions, but there are variances in attitudes about organic food. There are also some disparities in the elements that respondents evaluate while purchasing organic food.

Keywords: Organic foods; attitudes toward organic foods; X generation; Y generation.

### **INTRODUCTION**

Along with the times and technological developments that occurred, people began to experience changes in lifestyle. According to (Jain 2010), currently Indians prefer to eat fast food, are practical, and like foods that contain fat. Moreover, by rarely doing activities that can make the body healthier, such as exercise or walking, Indian people often get sick. Changes in people's lifestyles into unhealthy lifestyles, lack of physical activity and poor eating habits result in a shift from communicable diseases to non-communicable diseases such as obesity, lung cancer, heart disease, digestive disorders, stroke, and other internal harm that can lead to death. (Vardhini, Raja, and Kabirdoss 2016)

The role of Agriculture in the postmodern economy has changed considerably due to the industrialization process that took place between the middle and the end of the 20th century and which Kuznets called "the modern growth of the economy". Within this process of industrial transformation of the "Agriculture of the new economy" that takes into account the markets for differentiated products, where the demand for food increasingly depends on the socioeconomic characteristics of the population and a series of product quality attributes. These quality attributes are valued according to the subjective perception of the consumer, and are usually the nutritional content, confidence or safety in the mode of production and the impact that its cultivation generates on the environment. Recent studies on the perception of consumers about biotechnology and genetically modified foods conclude that some consumers buy a cheap product to the extent that they do not identify it as such or if they identify it, they do not care that it is genetically modified. But those who are willing to pay a higher price for a "healthy" product, it is because they perceive that they will have less health risk by its consumption. (Antle 1999)

Organic farming is a production method that is intended to be sustainable and harmonious with environment. This method prohibits the use of fertilizers and synthetic pesticides, manufactured products with gene modification, irradiation as a process preservation, sewage sludge as fertilizer, and chemical material. The main difference between organic farming and conventional is the absence of use of chemical fertilizers. Organically reared livestock must be given to eat with natural or organic food ingredients. Consumers feel organic food is healthier, have more quality and safety than conventional food because it is produced with organic farming (Blair, 2012).

### **LITERATURE REVIEW:**

Consumers' purchasing intentions toward organic food are influenced by environmental concerns, health reasons, and perceived value, according to the findings of the study. Surprisingly, organic food knowledge has little bearing on the intention to purchase organic food. The study's findings offer marketers and food manufacturer's valuable insight into the elements that influence customers' desire to buy organic food. The findings of the study can help marketers communicate with their customers through nonverbal means like perception. (Hassan, Yee, and Ray 2015)

The impression of organic product worth and belief in the product's safety and health aspects have a significant impact on the desire to purchase organic foods. Organic buyers and non-buyers were separated among the

respondents. Organic food, according to most organic shoppers, is healthier, tastier, and better for the environment than conventional food. (Ahmad, S. 2010).

According to previous study on organic food consumption, the most prominent reasons for not purchasing organic food are the goods' lack of availability and greater price as compared to conventionally produced food products, which are cheaper and easier to obtain. The findings show that willingness to pay is strongly and positively related to income and risk aversion, but not to education. (Boccaletti, S. & Nardella, M. 2000)

In this study, it was discovered that there is a link between respondents' occupation and their purchase of organic products, however there is no link between respondents' annual income and their purchase of organic products. When it comes to purchasing, the majority of respondents prioritize quality. (Vardhini et al. 2016)

The relationship between organic food qualities and abstract ideals like "security," "hedonism," "universalism," "benevolence," "stimulation," "self-direction," and "conformity" can help explain why people buy organic food. Using these ideals to persuade people to eat organic food can have a good impact. Aside from attitude, subjective and personal norms, as well as (perceived) behavioral control, all have an impact on organic food intake. (Aertsens et al. 2009)

Consumer preferences clearly show that cleanliness/freshness of food products is their top priority, followed by price, quality, variety, packaging, and non-seasonal availability. The convenience of purchasing at the marketplace, as well as the availability of additional services, children's attractions, basic comforts, and pricing, are all factors that influence consumer preference. The findings indicate that the majority of food and grocery goods are acquired in loose form from nearby stores. Due to their perishable nature, fruits and vegetables are purchased on a daily or twice-weekly basis, whereas grocery products are purchased less regularly. (Ali, Kapoor, and Moorthy 2010)

According to the findings, customer attitudes toward organic food in China are influenced by health consciousness, consumer knowledge, and personal norms. In other words, the more health-conscious consumers are, the more knowledge/experiences they have gained, or the more positive their particular ideas about the benefits of eating organic food, the more positive their attitude will be. Due to the rejection of their assumptions, two components of environmental concern and subjective standards, on the other hand, show no evident influence on consumer attitude. (Yang and Sattari 2014)

Organic food is increasingly preferred by health-conscious people over conventionally cultivated food. The increased frequency of lifestyle ailments such as heart disease and depression has had a significant impact on modern consumers' attitudes. The necessity to purchase organic food in order to improve one's quality of life will have significant ramifications for businesses' retail, distribution, and marketing responsibilities. (Rana and Paul 2017)

Among the explanatory variables in the expert survey, the importance put on health motivation has the highest average rating and one of the lowest standard deviations. Experts also place a high value on the three mentioned attitudes (conviction about the utility of organic food, store reputation, and certification process-related information), as well as organic food-specific consumer innovativeness, organic food-specific consumer opinion leadership, word of mouth activity, WOM (praise), and affective commitment to the store. (Chakrabarti 2010)

## **OBJECTIVES**

1. To study the awareness of organic food among X, and Y generations.
2. To analyze the factors which influence the purchase decision for organic food among X and Y generations.
3. To find out the availability & accessibility of the organic foods.

## **RESEARCH METHODOLOGY**

The type of research used is quantitative research with a comparative approach. The population used in this study are the people who live in Pune City who have consumed organic food. The sampling technique used is a non-probability sampling technique, namely quota sampling. The sample in this study is the people of Pune and have consumed organic food, have age criteria that are in accordance with the age of the generation X (1965-1980) and generation Y (1981 – 1999). In 2021 the Generation X is 41 years– 56 years, and the age of generation Y is 22 years – 40 years.

The primary data collection methods and procedures in this study were carried out by distributing online questionnaires during November 2021. The questionnaire distributed was a questionnaire with closed ended questions where alternative answers had been provided by the author. Respondents will be asked to give their

opinion on a series of statements related to the variables being studied. The measurement scale that will be used is the 5-point Likert Scale. From the questionnaires conducted, a total of 148 samples were obtained with 18 samples of generation X, and 130 samples of generation Y.

In this study, data processing used descriptive statistical analysis techniques. In descriptive statistical analysis technique, the authors compare the attitudes towards organic food to provide an overview or description of the differences between generations.

**RESULTS AND DISCUSSION**

**Table 1:** Respondent Description Profile:

	Generation X	%	Generation Y	%	Total	%
<b>Gender</b>						
Male	10	55.55	90	69.23	100	67.56
Female	8	44.45	40	30.77	48	32.44
Others	0	0	0	0	0	0
<b>Total</b>	<b>18</b>	<b>100</b>	<b>130</b>	<b>100</b>	<b>148</b>	<b>100</b>
<b>Occupation</b>						
Student	2	11.11	81	62.30	83	56.08
Entrepreneur	1	5.56	6	4.61	7	4.8
Housewife	0	0	2	1.54	2	1.30
Private employee	7	38.88	27	20.76	34	22.97
Government employee	1	5.56	0	0	1	0.67
Professional	6	33.33	14	10.7	20	13.51
Retired	1	5.56	0	0	1	0.67
<b>Total</b>	<b>18</b>	<b>100</b>	<b>130</b>	<b>100</b>	<b>148</b>	<b>100</b>

Table 1 shows the identity of the respondents in terms of age, gender and occupation. Overall the majority of respondents obtained in this study were male respondents with a total of 100 respondents. The majority of respondents' with a percentage of 56.08 % are students followed by private employees at 23 %.

**Table 2.** Awareness of Organic Food:

	Generation X	%	Generation Y	%	Total	%
<b>Awareness</b>						
Yes	18	100	130	100	148	100
No	0	0	0	0	0	0
<b>Total</b>	<b>18</b>	<b>100</b>	<b>130</b>	<b>100</b>	<b>148</b>	<b>100</b>
<b>Purchased/Consumed</b>						
Yes	18	100	123	94.61	141	95.27
No	0	0	7	5.39	7	4.73
<b>Total</b>	<b>18</b>	<b>100</b>	<b>130</b>	<b>100</b>	<b>148</b>	<b>100</b>

According to table 2 data, 100% respondents are aware about the organic food. All the respondents from generation X have purchased or consumed organic foods at least once whereas around 5 % of respondents from generation Y have never purchased/consumed organic food.

**Table 3.** Types of Organic Food Ever Purchases/Consumed by Respondents:

	Generation X	%	Generation Y	%	Total	%
<b>Type of Organic Food</b>						
Vegetables	16	29.09	113	24.40	129	24.90
Fruit	12	21.81	102	22.03	114	22
Grains	12	21.81	56	12.09	68	13.12
Rice	6	10.90	48	10.36	54	10.42
Milk	4	7.27	58	12.52	62	11.96
Meat	1	1.81	23	4.96	24	4.63
Egg	3	5.45	41	8.85	44	8.49
Fish	1	1.81	22	4.75	23	4.44
<b>Total</b>	<b>55</b>	<b>100</b>	<b>463</b>	<b>100</b>	<b>518</b>	<b>100</b>

According to table 3 data, the 2 types of organic food majorly consumed by the generation X and generation Y are vegetables and fruits. Generation X also seemed to have affinity towards organic grains and generation Y towards organic milk to a certain extent.

**Table 4.** Reasons for trying/ consuming organic food by the respondents:

	Generation X	%	Generation Y	%	Total	%
<b>Reasons for trying/consuming Organic Food</b>						
Health Benefits	16	55.17	121	58.45	137	58.05
Recommendation from family and friends	7	24.13	44	21.25	51	21.61
Status	1	3.44	0	0	1	0.42
Social Cause :Support Organic Farming	5	17.24	39	18.84	44	18.64
Other	0	0	3	1.44	3	1.27
<b>Total</b>	<b>29</b>	<b>100</b>	<b>207</b>	<b>100</b>	<b>236</b>	<b>100</b>

The majority of respondents from the X generation as much as 55%, generation Y as much as 58 % stated that the reason for trying/consuming organic food is because of its health benefits. Also both groups followed the recommendation on organic foods from their family and friends. Both the group also agreed on supporting organic farming on a social cause. So it can be concluded that the interest in buying organic food from each generation is very high.

**Table 5.** Attitude towards organic food of the respondents:

Variable	Generation X			Generation Y		
	Mean	SD	n	Mean	SD	n
Organic Foods are healthier than the ordinary foods.	4.56	0.7	18	4.55	0.76	130
Organic foods have no harmful effects on the human body.	4.61	0.5	18	4.27	0.86	130
Organic food is more delicious than ordinary food.	4.11	0.83	18	3.92	0.89	130
Organic food is more attractive than ordinary food.	3.44	0.86	18	3.67	0.96	130
Organic food is better than conventional food.	4.22	0.88	18	4.23	0.90	130
Organic food is expensive than conventional food.	4.44	0.61	18	4.35	0.89	130

Results in table 5 show that many of the respondents from both generations agreed that organic foods are healthier than the ordinary foods and organic foods have no harmful effects on the human body.

Both the generations feel that organic food is expensive than conventional food (Gen X, M=4.44, Gen Y, M=4.35)

Looking at the mean score results, majority of Generation X (M=4.22) and Generation Y (M=4.23) also feel that organic food is better than conventional food.

More of Generation X (M= 4.11) feel that organic foods are delicious than ordinary food compare to Generation Y (M=3.92), whereas more of Generation Y (M=3.67) feel that organic foods are attractive than ordinary food compared to Generation X (M=3.44).

**Table 6.** Factors considered while buying organic food by the respondents:

	Generation X	%	Generation Y	%	Total	%
<b>Factors considered while buying organic food</b>						
Fresh Produce	14	18.18	101	18.87	115	18.79
Cost	12	15.58	50	9.35	62	10.13
Availability	9	11.68	53	9.90	62	10.13

Nutrition	10	12.98	94	17.57	104	16.99
Care for environment/ Preserve our ecosystem	7	9.09	48	8.97	55	8.98
Avoiding chemicals & pesticides	10	12.98	94	17.57	104	16.99
Avoid hormones, antibiotics and drugs in animal products	8	10.38	48	8.97	56	9.15
Support farming directly	7	9.09	47	8.78	54	8.82
<b>Total</b>	<b>77</b>	<b>100</b>	<b>535</b>	<b>100</b>	<b>612</b>	<b>100</b>

Based on table 6, it is known that the X and Y generations in the variables of Cost, Availability, Nutrition, Avoiding chemicals & pesticides, Avoid hormones, antibiotics and drugs in animal products indicators have significant differences, but the Fresh Produce, Care for environment and Support farming indicators have no significant differences. So, it can be concluded that indicators that have significant differences are indicators of Cost, Availability, Nutrition, Avoiding chemicals & pesticides, Avoid hormones, antibiotics and drugs in animal products.

**Table 7.** Preference of buying organic food online or by visiting organic food store by the respondents:

	Generation X	%	Generation Y	%	Total	%
<b>Preference</b>						
Online	02	11.11	23	17.69	25	16.89
Store	16	88.88	107	82.31	123	83.11
<b>Total</b>	<b>18</b>	<b>100</b>	<b>130</b>	<b>100</b>	<b>148</b>	<b>100</b>

Based on table 7, it is known that majority of X and Y generations i.e. 89% and 82% like to purchase the organic by visiting an organic food store, whereas few generation Y i.e. 18% respondents prefer to buy online.

**Table 8.** Average spend on organic food monthly by the respondents:

	Generation X	%	Generation Y	%	Total	%
<b>Average Spend</b>						
Less than 1000	02	11.11	63	48.46	65	43.92
1000-3000	16	88.88	63	48.46	79	53.37
Above 5000	0	0	4	3.08	04	2.71
<b>Total</b>	<b>18</b>	<b>100</b>	<b>130</b>	<b>100</b>	<b>148</b>	<b>100</b>

Results in table 8 show that many of the respondents from generations X i.e. 89% spend roughly Rs. 1000-3000 Monthly on organic food. Whereas equal respondents from generation Y i.e. 48% each spend Less than Rs. 1000 and Rs. 1000-3000 respectively on purchase of organic food.

**Table 9.** Accessibility of organic food store to the respondents:

	Generation X	%	Generation Y	%	Total	%
<b>Easy accessibility</b>						
Yes	11	61.11	68	52.30	79	53.38
No	07	38.89	62	47.70	69	46.62
<b>Total</b>	<b>18</b>	<b>100</b>	<b>130</b>	<b>100</b>	<b>148</b>	<b>100</b>

Results in table 9 show that the majority of respondents from the X generation as much as 61%, generation Y as much as 52% stated that the organic food store is accessible to them

**Table 10.** Organic food stores opening and accessibility will have a positive impact on your buying decision of the respondents:

	Generation X	%	Generation Y	%	Total	%
<b>Yes</b>						
Yes	11	61.11	68	52.30	79	53.38
No	07	38.89	62	47.70	69	46.62
<b>Total</b>	<b>18</b>	<b>100</b>	<b>130</b>	<b>100</b>	<b>148</b>	<b>100</b>

The majority of respondents from the X generation as much as 61% and generation Y as many as 52% stated that better availability and accessibility of organic food stores will have a positive impact on their buying decision.

## FINDINGS

1. Among generation X 55.5% of the respondents are male whereas 45.5 % of the respondents are female, majority of respondents being private employees and professionals. Among generation Y about 69 % of population is male whereas 31 % of the respondents are female, majority of respondents being students and private employees.
2. All the respondents are aware about the organic food. Entire respondents from generation X have purchased or consumed organic foods at least once whereas around 5 % of respondents from generation Y have never purchased/consumed organic food.
3. 2 types of organic food majorly consumed by the generation X and generation Y are vegetables and fruits. Generation X also seemed to have affinity towards organic grains and generation Y towards organic milk to a certain extent.
4. The majority of respondents from the X generation & generation Y stated that the reason for trying/consuming organic food is because of its health benefits. Also both groups followed the recommendation on organic foods from their family and friends. Both the group also agreed on supporting organic farming on a social cause. So it can be concluded that the interest in buying organic food from each generation is very high.
5. Many of the respondents from both generations agreed that organic foods are healthier than the ordinary foods and organic foods have no harmful effects on the human body. Both the generations feel that organic food is expensive than conventional food.
6. Majority of Generation X and Generation Y also feel that organic food is better than conventional food.
7. More of Generation X feel that organic foods are delicious than ordinary food compare to Generation Y, whereas more of Generation Y feel that organic foods are attractive than ordinary food compared to Generation X.
8. X and Y generations in the variables of Cost, Availability, Nutrition, Avoiding chemicals & pesticides, Avoid hormones, antibiotics and drugs in animal products indicators have significant differences, but the Fresh Produce, Care for environment and Support farming indicators have no significant differences. So, it can be concluded that indicators that have significant differences are indicators of Cost, Availability, Nutrition, Avoiding chemicals & pesticides, Avoid hormones, antibiotics and drugs in animal products.
9. It is known that majority of X and Y generations like to purchase the organic by visiting an organic food store, whereas few generation Y respondents prefer to buy online.
10. Many of the respondents from generations X spend roughly Rs. 1000-3000 monthly on organic food. Whereas equal respondents from generation Y spend less than Rs. 1000 and Rs. 1000-3000 respectively on purchase of organic food.
11. Majority of respondents from the X generation & generation Y stated that the organic food store is accessible to them and agreed that better availability and accessibility of organic food stores will have an positive impact on their buying decision.

## CONCLUSION

This study aimed at discovering the differences in organic food awareness and attitudes between the 'X' and 'Y' generations Organic foods are growing increasingly popular among consumers. As a result of our current research investigation, both generations are aware of organic products.

The study clearly reflects the factors while buying organic food among 'X' and 'Y' generations in the variables of Cost, Availability, Nutrition, Avoiding chemicals & pesticides, Avoid hormones, antibiotics and drugs in animal products. Both the generations are highly aware of the importance of health and safety. Recommendations from families and friends are the driving forces behind customers' decisions to buy organic food products. Increased availability and accessibility of organic food stores will have a favorable impact the purchasing decisions of consumers.

## SUGGESTIONS

1. Organic food-related businesses can be more aggressive in presenting various sorts of organic food to the community than fruits and vegetables, so that people are aware that organic food is not restricted to fruits and vegetables.

2. In both the generations the attitude toward organic food is found fairly high, indicating that the majority of respondents who have consumed organic food have a good view. As a result, marketers should not be scared to promote organic food to individuals who have never had it by using salad packing and mixing salad with various types of dressing.
3. Further research could be expanded by looking into other cities or generations outside the Generation X, and Generation Y.

#### **BIBLIOGRAPHY**

1. Aertsens, Joris, Wim Verbeke, Koen Mondelaers, and Guido Van Huylenbroeck. 2009. "Personal Determinants of Organic Food Consumption: A Review." *British Food Journal* 111:1140–67. doi: 10.1108/00070700910992961.
2. Ahmad, siti nor bayaah. 2010. "Organic Food: A Study On Demographic Characteristics And Factors Influencing Purchase Intentions Among Consumers In Klang Valley, Malaysia." *International Journal of Business and Management* 5. doi: 10.5539/ijbm.v5n2p105.
3. Ali, J., Sanjeev Kapoor, and Janakiraman Moorthy. 2010. "Buying Behaviour of Consumers for Food Products in an Emerging Economy." *British Food Journal* 112:109–24. doi: 10.1108/00070701011018806.
4. Antle, John M. 1999. "The New Economics of Agriculture." *American Journal of Agricultural Economics* 81(5):993–1010. doi: 10.2307/1244078.
5. Boccaletti, S., and Nardeela, M. 2000. "Consumer Willingness to Pay for Pesticide-Free Fresh Fruit and Vegetables in Italy." *The International Food and Agribusiness Management Review* 3(3):297–310. doi: 10.1016/S1096-7508(01)00049-0.
6. Chakrabarti, Somnath. 2010. "Factors Influencing Organic Food Purchase in India – Expert Survey Insights." *British Food Journal* 112:902–15. doi: 10.1108/00070701011067497.
7. Eynade, Gabriel Adewunmi, Abbyssinia Mushunje, and Shehu Folaranmi Gbolahan Yusuf. 2021. "The Willingness to Consume Organic Food: A Review." *Food and Agricultural Immunology* 32(1):78–104. doi: 10.1080/09540105.2021.1874885.
8. Hassan, Siti, Loi Yee, and Kok Ray. 2015. "Purchasing Intention towards Organic Food among Generation Y in Malaysia." *Journal of Agribusiness Marketing* 7:16–32.
9. Jain, Namita. 2010. "Why Are Junk Food and Fast Food so Popular?" *The Hindu*, January 20.
10. Paik, InKee. 2012. "Organic Production and Food Quality: A Down to Earth Analysis." *Asian-Australasian Journal of Animal Sciences* 25:749–50. doi: 10.5713/ajas.2012.b.01.
11. Rana, Jyoti, and Justin Paul. 2017. "Consumer Behavior and Purchase Intention for Organic Food: A Review and Research Agenda." *Journal of Retailing and Consumer Services* 38:157–65. doi: 10.1016/j.jretconser.2017.06.004.
12. Vardhini, V., P. Raja, and Devi Kabirdoss. 2016. "A Study on Consumer Awareness about the Organic Products in Chennai City among Students and Executives." *International Journal of Management and Social Sciences* 1:160–65.
13. Yang, Mingyan, and Setayesh Sattari. 2014. "Consumer Attitude and Purchase Intention towards Organic Food." 67.

---

---

## **Pandemics - An Environmental Diet**

**Ganatra Kashyap**

Department of Accountancy and Commerce, B. M. Ruia Girls' College, Gamdevi, Mumbai, India

### **ABSTRACT**

It can be hard to imagine a silver lining to the all-consuming cloud that is the current and ongoing spread of Covid-19 across the planet, but, as cities and lives are pulled to a standstill by communicable disease, our skies and rivers are revealing an unexpected positive to the pandemic. While the beneficial effects for our environment by no means reduce the anguish and suffering caused by such an outbreak, economic slowdown and reduced travel as a result of government-enforced quarantines has put a dramatic cap on outgoing pollution and the effects are being seen all over the world. This paper focuses on the Impact of Pandemics on the Environment because it has a diet impact by re-generating the environment but the question is that - Is it a permanent positive impact ?

Keywords: Covid-19, Corona Virus, Environment, Pollution, Pandemic

### **INTRODUCTION**

About two-thirds of all infectious diseases in humans have their origins in animals. Scientists say the ability of a virus to mutate and adapt from animals to the human system is very rare, but the expansion of the human footprint is making that rare event much more likely.

For most people, up until the novel coronavirus took over the headlines, the possibility of a new disease emerging out of nowhere and spreading around the world at a breakneck pace seemed like something out of a science fiction movie. But some members of the scientific community have been sounding the alarm for decades, warning that it was not a matter of if, but when another pandemic would threaten humanity.

### **IMPACT ON ENVIRONMENT**

Compared to what so many are experiencing, the impact on Nature has been relatively small, but nonetheless historic. The skies are clearing of pollution, wildlife is returning to newly clear waters, a host of flights have been scrapped and crude oil is so worthless that the industry would have to pay you to take it off their hands – a few months ago, environmentalists could only dream of such a scenario as the 50th anniversary of Earth Day came into view.

But this disorientingly green new reality is causing little cheer given the cause is the coronavirus pandemic that has ravaged much of the world.

“This isn’t the way we would’ve wanted things to happen, God no,” said Gina McCarthy, former head of the US Environmental Protection Agency in the Obama administration. “This is just a disaster that pointed out the underlying challenges we face. It’s not something to celebrate.”

The recent annual Earth Day event, this year largely took place online, came as a public health restriction to prevent the spread of Covid-19, has resulted in a sharp dip in air pollution across China, Europe and the US, with carbon emissions from the burning of fossil fuels reporting a record 5% annual drop.

The waters of Venice are now clear, lions lounge on roads normally frequented by safari-goers in South Africa and bears and coyotes wander around empty accommodation in Yosemite national park in California.

Meanwhile, nearly eight in 10 flights globally have been canceled, with many planes in the US carrying just a handful of people. The oil industry, a key driver of the climate crisis and direct environmental disaster, is in turmoil, with a barrel of crude hitting an unprecedented figure.

These would perhaps be the sort of outcomes seen had stringent environmental policies been put in place in the wake of the first Earth Day in 1970, which saw 20 million Americans rally in support of anti-pollution measures.

Instead, the pain of the Covid-19 shutdown has highlighted how ponderous the world’s response has been – the expected cut in emissions, for example, is still less than what scientists say is needed every year this decade to avoid disastrous climate impacts for much of the world.



“It’s the worst possible way to experience environment improvement and it has also shown the size of the task,” said Michael Gerrard, an environmental law expert at Columbia University.

McCarthy, now head of the Natural Resources Defense Council, noted that some Indian people were seeing the Himalayas for the first time due to the veil of air pollution lifting.

“You wonder if people will want to go back to what it was like before,” she said. “The pandemic has shown people will change their behavior if it’s for the health of their families. This has been the lost message on climate, that it’s a human problem, not a planetary problem. We have to show you can have a stable environment and your job, too.”

The problems in the natural world haven’t suddenly vanished – various researchers found that the Arctic is very likely to be free of sea ice in summers before 2050, that the bushfires that torched Australia earlier released more carbon than the country’s annual CO<sub>2</sub> output and that the first quarter of 2020 was the second-warmest on record.

Conservationists also warn that returning the world to its pre-pandemic settings will quickly wipe out any environmental benefits of the shutdown i.e. failure of the crash course environmental diet plan.

“It’s a serious wake-up call,” said Thomas Lovejoy, an ecologist who coined the term “biological diversity”. “We bulldoze into the last remaining places in nature and then are surprised when something like this happens. We have done this to ourselves by our continual intrusion into nature. We have to re-chart our course.”

### **LESSONS FOR THE FUTURE**

As the coronavirus pandemic unfolds across the globe, threatening lives and upending the world economy, it’s also had a profound impact on the environment. Scientists first noticed a decrease in greenhouse gas emissions in China, where the pandemic began. This trend followed the pandemic’s spread across the world. Meanwhile, viral social media posts started to pop up about wildlife sightings in urban areas, claiming “nature just hit the reset button on us.”

Less reported has been the dramatic rise in medical waste and packaging from online shopping.

A global pandemic that is claiming people’s lives certainly shouldn’t be seen as a way of bringing about environmental change either. For one thing, it’s far from certain how lasting this dip in emissions will be. When the pandemic eventually subsides, will carbon and pollutant emissions “bounce back” so much that it will be as if this clear-skied interlude never happened? Or could the changes we see today have a more persistent effect?

The first thing to consider, says Kimberly Nicholas, a sustainability science researcher at Lund University in Sweden, is the different reasons that emissions have dropped. Take transport, for example, which makes up 23% of global carbon emissions. These emissions have fallen in the short term in countries where public health measures, such as keeping people in their homes, have cut unnecessary travel. Driving and aviation are key contributors to emissions from transport, contributing 72% and 11% of the transport sector’s greenhouse gas emissions respectively.

Reduction in the duration of travel during the pandemic has emission levels lowered. But what will happen when measures are eventually lifted? In terms of routine trips like commuting, those miles left untravelled during the pandemic aren’t going to come back – you’re not going to travel to the office twice a day to make up for all the times you worked from home, says Nicholas. But what about other kinds of travel – might the cabin-fever of self-isolation encourage people to

travel more when the option is there again? It may be the case that people who are avoiding travel right now are really appreciating spending time with families and focusing on those really core priorities. These moments of crisis can highlight how important those priorities are and help people focus on the health and wellbeing of family, friends and community.” If this change in focus as a result of the pandemic sticks, then this could help to keep emissions lower.

But there’s another way it could go. “It could also be that people are putting off long-distance trips but plan on taking them later.” Frequent flying forms a large part of the carbon footprint for people who do it regularly, so these emissions could simply come back if people return to their old habits. Also, this is not the first time an epidemic has left its mark on atmospheric carbon dioxide levels. Throughout history, the spread of disease has been linked to lower emissions – even well before the industrial age. The impact from today’s outbreak is not predicted to lead to anywhere near the same number of deaths, and it is unlikely to lead to widespread change in

landuse. Its environmental impacts are more akin to those of recent world events, such as the financial crash of 2008 and 2009. "Then, global emissions dropped immensely for a year," says Pongratz.

The reduction in emissions then was largely due to reduced industrial activity, which contributes carbon emissions on a comparable scale to transport. Combined emissions from industrial processes, manufacturing and construction make up 18.4% of global anthropogenic emissions. The financial crash of 2008-09 led to an overall dip in emissions of 1.3%. But this quickly rebounded by 2010 as the economy recovered, leading to an all-time high.

"There are hints that coronavirus will act the same way," says Pongratz. "For example, the demand for oil products, steel and other metals has fallen more than other outputs. But there are record-high stockpiles, so production will quickly pick up."

One factor that could influence whether or not these emissions bounce back is how long the coronavirus pandemic lasts. "At the moment that's hard to predict," says Pongratz. "But it could be that we see longer-term and more substantial effects. If the coronavirus outbreak continues to the end of the year then consumer demand could remain low because of lost wages. Output and fossil fuel use might not recover that quickly, even though the capacity to do so is there."

## CONCLUSION

### COMMUNITY ACTION

One response to the coronavirus outbreak that has drawn mixed reactions from climate scientists is the ways that many communities have taken big steps to protect each other from the health crisis. The speed and extent of the response has given some hope that rapid action could also be taken on climate change if the threat it poses was treated as urgently.

"It shows that at the national, or international level, if we need to take action we can," Donna Green, associate professor at University of New South Wales's Climate Change Research Centre in New Zealand, told CNN. "So why haven't we for climate? And not with words, with real actions."

But for others, such as Nicholas, the community action has sparked hope for the climate in the longer term. And Pongratz sees the time afforded by self-isolation as a good opportunity for people to take stock of their consumption.

It's safe to say that no one would have wanted for emissions to be lowered this way. Covid-19 has taken a grim global toll on lives, health services, jobs and mental health. But, if anything, it has also shown the difference that communities can make when they look out for each other – and that's one lesson that could be invaluable in dealing with climate change.

Also, we can safely say that the environment is on a recovery mode diet plan compelled by the outbreak of this pandemic but perhaps the dim light at the end of this long and distressing Covid-19 tunnel could be healthier environments in cities worldwide subject to we not forgetting the lessons learnt the hard way and not resorting to our earlier ways.

## REFERENCES

1. "Earth Observatory". Archived from the original on 2020-04-02. Retrieved 2020-04-09.
2. Team, The Visual and Data Journalism (28 March 2020). "Coronavirus: A visual guide to the pandemic". BBC News. Archived from the original on 27 March 2020.
3. Myllyvirta, Lauri (19 February 2020). "Analysis: Coronavirus has temporarily reduced China's CO2 emissions by a quarter". CarbonBrief. Archived from the original on 4 March 2020. Retrieved 16 March 2020.
4. McMahon, Jeff (16 March 2020). "Study: Coronavirus Lockdown Likely Saved 77,000 Lives In China Just By Reducing Pollution". Forbes. Archived from the original on 17 March 2020. Retrieved 16 March 2020.
5. "Cop26 climate talks postponed to 2021 amid coronavirus pandemic". Climate Home News. 1 April 2020. Archived from the original on 4 April 2020. Retrieved 2 April 2020.
6. Newburger, Emma (13 March 2020). "Coronavirus could weaken climate change action and hit clean energy investment, researchers warn". CNBC. Archived from the original on 15 March 2020. Retrieved 16 March 2020.

7. "Is sea level rising?". National Oceanic and Atmospheric Administration. Archived from the original on 2020-02-18. Retrieved 2020-04-06.
8. "Climate Change". National Geographic Society. 2019-03-28. Archived from the original on 2019-12-31. Retrieved 2020-04-06.
9. Madhav, Nita; Oppenheim, Ben; Gallivan, Mark; Mulembakani, Prime; Rubin, Edward; Wolfe, Nathan (2017), Jamison, Dean T.; Gelband, Hellen; Horton, Susan; Jha, Prabhat (eds.),
10. "Pandemics: Risks, Impacts, and Mitigation", Disease Control Priorities: Improving Health and Reducing Poverty (3rd ed.), The International Bank for Reconstruction and Development / The World Bank, doi:10.1596/978-1-4648-0527-1/pt5.ch17 (inactive 2020-04-13), ISBN 978-1- 4648-0527-1, PMID 30212163, archived from the original on 2020-03-23, retrieved 2020-04-06
11. Kopnina, Helen; Washington, Haydn; Taylor, Bron; J Piccolo, John (2018-02-01). "Anthropocentrism: More than Just a Misunderstood Problem". *Journal of Agricultural and Environmental Ethics*. 31 (1): 109–127. doi:10.1007/s10806-018-9711-1. ISSN 1573-322X.
12. Rull, Valentí (2016-09-01). "The humanized Earth system (HES)". *The Holocene*. 26 (9): 1513–1516. Bibcode:2016Holoc..26.1513R. doi:10.1177/0959683616640053. ISSN 0959-6836.
13. Watts, Jonathan; Kommenda, Niko (23 March 2020). "Coronavirus pandemic leading to huge drop in air pollution". *The Guardian*. Archived from the original on 4 April 2020. Retrieved 4 April 2020.
14. editor, Damian Carrington Environment (2020-04-07). "Air pollution linked to far higher Covid-19 death rates, study finds". *The Guardian*. ISSN 0261-3077. Archived from the original on 2020-04-09. Retrieved 2020-04-10.
15. "The Global Impacts of the Coronavirus Outbreak". Center for Strategic and International Studies. Archived from the original on 7 April 2020. Retrieved 4 April 2020.
16. Green, Matthew (13 March 2020). "Air pollution clears in northern Italy after coronavirus lockdown, satellite shows". *Reuters*. Archived from the original on 16 March 2020. Retrieved 16 March 2020.

## Status of Women in Higher Education with Special Reference to Assam

Pallabi Goswami<sup>1</sup>, Bhabana Chutiya<sup>2</sup> and Nirmali Puzari<sup>3</sup>

<sup>1</sup>Pulibor Adarsha Vidyapith H.S. School Golaghat, Assam, India

<sup>2</sup>Department of Education, North Eastern Hill University, Shillong, India

<sup>3</sup>Kachua Multipurpose Higher Secondary School, Lakhimpur, Assam, India

### ABSTRACT

Women had faced gender discrimination in every field since ages. Because of this discrimination, women are still not getting equal status as men in the society. Education may bring tremendous change in this regard. It is the key to social change and makes women empower. Thus it is necessary for each and every woman to be Educated. But, why women need higher Education? The answer can be women empowerment. In other words, higher education makes women self reliant, economically wealthy and contributor for the development of the country. The present study is an effort to analyse the status of women in higher education special reference to Assam.

Keywords: Higher Education, Status, Women, Women Empowerment

### 1. INTRODUCTION

Women are the backbone of a family. In an old African proverb it is said that, "If you educate a man you educate an individual, but if you educate a woman you educate a family (nation) (Suen, S., 2013). The first education of a child begins from his home and mother is the first teacher of a child. To develop perception and knowledge about the various things in a child the mother should be educated first. It brings the importance of women education in the society. However, women were deprived of their basic human rights and were denied equal opportunities in all over the world (Jagaran, 2022). As a consequence, different socio- religious movement took place to empower the women and availed them their basic human rights. Access to education has been most crucial demand of these socio- religious movements (Jagaran, 2022). Educating a woman helps her to lead a happy life, aware about her rights and raising voice against the injustice took place in the society. Moreover, women population took half of the place of total population, so government as well as the nation will also be benefited by educating them; produce human resources for the development of nation.

In India conscious efforts were made by different social reformers to promote women education. But the status of women's education in India was below the level of satisfactory as the literacy rate of women was increasing from 0.2% in 1988 to only 6% in 1947. (Dahal, C., 2021) Thus, higher education of women has been neglected for centuries. The educational status of women in Assam also was very poor as compared to the other states of the country. A great number of girl child dropouts from the education system before reaching to higher education. (Bora, L., Teron, N. & Boro, R., 2019). The reason behind the dropouts might be the tradition of early marriage of girls and beliefs that girls are born to be taken care of her family rather than doing any other jobs.

However, higher education is the only key for empowering a woman and it is also the pathway of economic security and opportunities for the women. Hence, it is very important for the country to make a flexible, equitable and accessible education system where women along with men can contribute for the development of the nation. (Bora, L., Teron, N. & Boro, R., 2019). From 2000, many Indian women play a major role in various fields of science, literature, research, economy, polity, art & culture, sports etc. By manifest themselves as the contributing member of the society through quality higher education in those fields. Higher Education in India for women observes major growth over the years and government also take intuitive to eradicate gender disparity from the higher education in India. (Packianathan, N., Anusree, S. M & Manjunatha, B., 2016).

### 2. OBJECTIVES OF THE STUDY

2.1 To study the status of Higher Education of women in India special reference to Assam.

2.2 To analyse the student enrolment in Higher Education based on gender.

### 3. METHODOLOGY

The present study is based on the secondary data collected from various websites including Magazines, Journals, Newspaper article, Govt. of India reports, Blogs etc. This data was analyzed and reviewed to draw the conclusion.

#### 4. Women and Higher Education in India:

Higher Education is referred as a system of education which can be obtained after 12 years of schooling. The institutional framework of higher education in India consists of Universities and colleges. According to NRF ranking list 2021, India has over 1000 universities and over 45,000 degree colleges. (India Today., September, 2021). It is the third largest higher education system in the world. India had a viable higher education system since 1000 B. C. However, those ancient learning centres only concerned with furnishing Vedic Education. The modern education system has its roots from colonial legacy. They used higher education as cultural colonization. (Wikipedia, March, 2022)

Although Women were deprived of higher education from ages, but in Vedic period women were actively participated in the higher education system. Gargi, Maitreyi, Apala, Sanghamitra were the well known women scholar in the Vedic Education. Moreover, in Buddhist education system India witnessed world famed Universities of Nalanda, Takshila and Vikramshila where numbers of girls' students were enrolled. Merely, they had lost their right gradually from later the Vedic age and medieval period. However, in the British period there was a re-establishment of women's education in India as an effect of the socio religious movements led by Raja Rammohan Roy, Ishwar Chandra Vidyasagar. (Mandal, P.) Eventually, government of India took many initiatives and formulate policies to promote higher education of women after the country got independence in 1947. The various report reflected the growth of higher education of women from 1947 to till date.

#### 5. Women and higher Education in Assam

Assam also had gender disparity in the field of education. There is no evidence that female were access to education in ancient Kamrup. Though during Ahom rule, the women from royal families took education informally, not accessible to all. It can be said that the formal education for women in Assam started with the establishment of British colonial rule in the state. The effort was made with an establishment of girls' school in Sadiya by Mrs. Brown in 1838. Consequently, the collective efforts of Baptist missionaries, British Government and reformers of the age made it possible to open numbers of different type of schools and colleges for women. By the year 1897-98, 185 primary schools were established and no. of girls enrolled was only 3823. (Moran, N., 2019). Till 19<sup>th</sup> century higher education in Assam had not started and in 1901, the first college of Assam Cotton College was started in Guwahati. Although, women were allowed to take admission after a long wait from its establishment i.e. on 1929. Sujata Roy was the only girl student in the college, when she took admission in 1929. After that in 1939 the first women college, Handique Girls' College was established, followed by opening of two more women colleges during 1940-41. Hence, higher education of women in Assam had started only from the 20<sup>th</sup> century. Sudhalata Duwara and Sukhalata Duwara, were the first MA BT from Assam. Additionally, Rajabala Das, Puspalata Das, Nalinibala Devi was the women who got higher education and inspired many women, opened up the path for women's higher education in Assam.,

In 1948, Gauhati University was established, and brought a remarkable change in the Higher Education for the girls. Moreover, Assam State Council for Women's Education, 1963 had provide valuable suggestions for the improvement of higher education of women, such as establishment of one college in each district, scholarship for girls, appointment of lady joint director at the higher education level etc. (Bora, L., Teron, N. & Boro, R., 2019). As a result of govt initiatives various Women's Studies Centres such as Chandraprabha Saikiani Centre for Women's Studies (Tezpur University, 2009), Department of Women's Studies under Gauhati University (2010) and Assam Women's University in Jorhat (2013) was established. Thus, all the initiatives helped in increasing the enrolment ration of girls in higher education.

#### 6. Status of Enrolment in higher Education in India

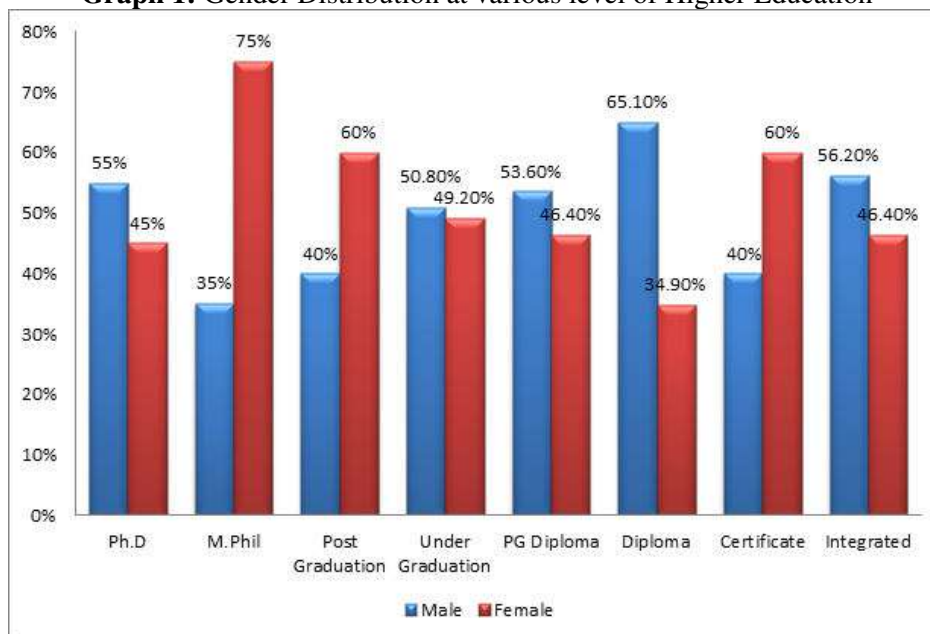
##### 6.1 Gender Distribution at various level of Higher Education in India

**Table 1:** Gender Distribution at various level of Higher Education

Levels	Male	Female
Ph.D	55%	45%
M.Phil	35%	75%
Post Graduation	40%	60%
Under Graduation	50.8%	49.2%
PG Diploma	53.6%	46.4%
Diploma	65.1%	34.9%
Certificate	40%	60%
Integrated	56.2%	46.4%

Source: AISHE 2019-2020

Graph 1: Gender Distribution at various level of Higher Education

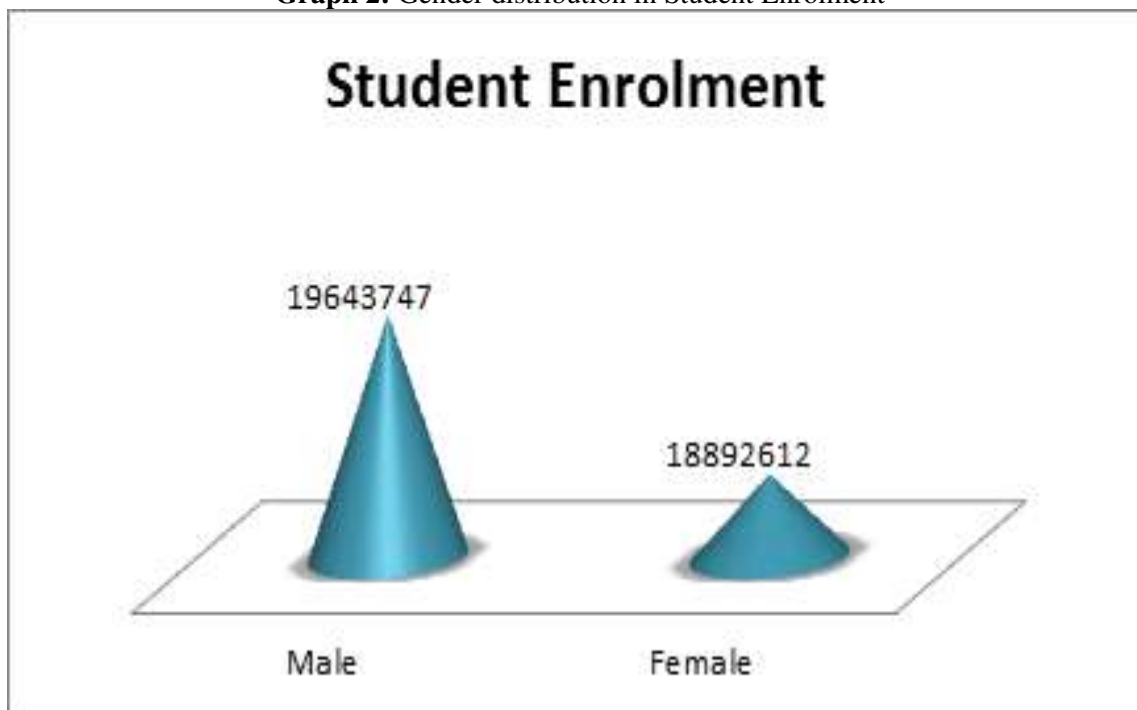


Source: AISHE 2019-2020

### 6.2 Gender distribution in Student Enrolment

The total student enrolment is approximately 3, 85, 36,359 out of which nearly 51% are male and rest 49% are female students.

Graph 2: Gender distribution in Student Enrolment



Source: AISHE 2019-2020

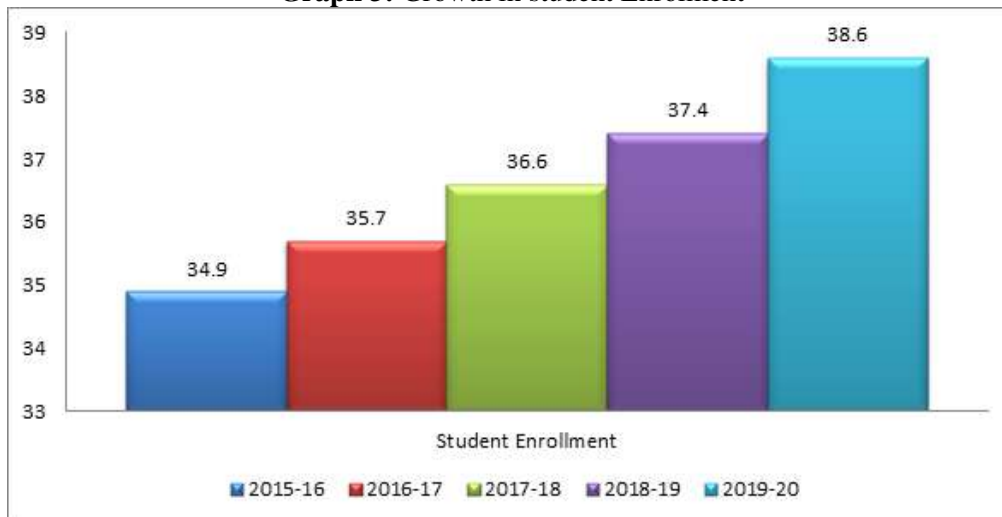
### 6.3 GER in higher Education

The Estimated Gross Enrolment Ratio (GER) in Higher education in India is 27.1%, which is calculated for 18-23 years of age group. GER for male population at all India level is 26.9% whereas for SC Male it is 22.8% and 18.2% for ST male. Likewise, GER for female population at all India level is 27.3% whereas for SC female it is 24.1% and for ST female, it is 17.7%.

### 6.4 Growth in student Enrolment

The enrolment has grown significantly during the last 5 years, which has increased from 3, 45, 84, 781 in 2015-16 to 3, 85, 36,359 in 2019-20. The overall growth is 11.4%.

Graph 3: Growth in student Enrolment



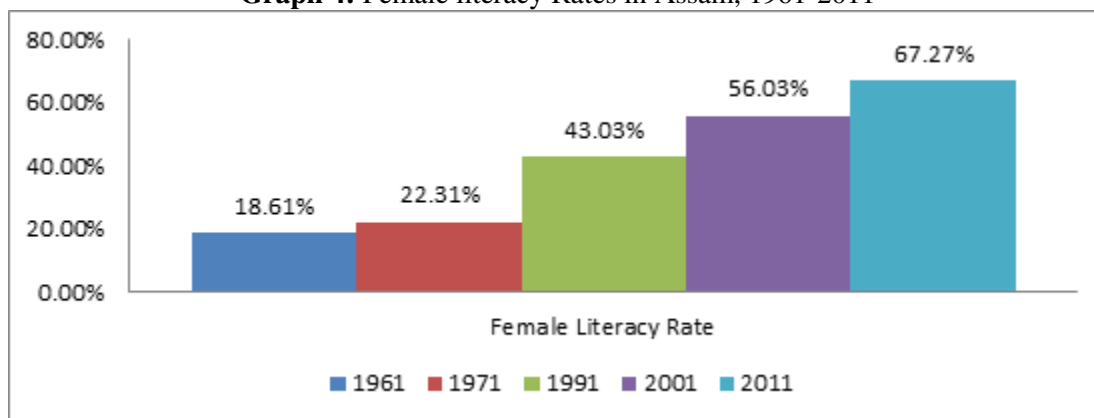
Source: AISHE 2019-2020

### 7. Literacy Rates in Assam, 1961-2011

Table 2: Literacy Rates in Assam, 1961-2011

Census Year	Persons	Males	Females	Gender Gap in literacy Rate
1961	35.58%	44.28%	18.61%	25.67%
1971	33.32%	42.96%	22.31%	20.65%
1981	N.A	N.A	N.A	N.A
1991	52.89%	61.87%	43.03%	18.84%
2001	64.28%	71.93%	56.03%	15.9%
2011	73.18%	78.81%	67.27%	11.54%

Graph 4: Female literacy Rates in Assam, 1961-2011



### 8. CONCLUSION

Education is the birth right for every person irrespective of gender, caste, region, religion, colour etc. In this context, women fought an extensive battle to attain these basic human rights not only in India but also all over the world. Education is the only tool for creating women empowerment and makes them self-reliant. The present study indicates remarkable changes in the field of Education in India as well as in Assam. It also indicates the increasing status of women literacy rate in Assam from 18.61% in 1961 to 67.27% in 2011. Although we can distinguish gender gap of 11.54% in literacy rate of Assam. Moreover, the present study shows that a gender disparity in Enrolment of students in higher education i.e. 51% male whereas 49% female. The reason behind this gender disparity is the patriarchal tradition and customs of our society. In Assam also female experiences ill effects of patriarchal norms and customs, which stop them in attaining equal educational opportunities. It is no doubt that today's girls are going far ahead from boys in almost every field. But, in reality the bigger picture articulates the gender disparity in the field of Higher Education. Hence, it is necessary to take appropriate measures in this context. It is the responsibility of government as well as people to promote higher education among all women. Without Education the development of women are not possible and without development of women over all development of our country is in vain.

---

---

**REFERENCES**

1. Suen, S. (2013). The education of women as a tool in development: challenging the African maxim. *Hydra*, 1(2), 60-76 file:///C:/Users/Rishikesh/Downloads/720-Article%20Text-2119-1-10-20131212.pdf
2. Jagaran (2022). Women's Education in India. <https://www.jagran.com/blogs/nimi78/womens-education-in-india/>
3. Dahal, C. (2021). Women Education in Colonial Assam as Reflected In Contemporary Archival And Literary Records. *International Journal of Humanities and Social Science*, 8(3), 80-86 <http://www.internationaljournalsrg.org/IJHSS/paper-details?Id=325>
4. Bora, L., Teron, N. & Boro, R. (2019). Status of Women and Higher Education in Assam. *International Journal of Engineering Development and Research*, 7(3), 572-574 <https://www.ijedr.org/papers/IJEDR1903099.pdf>
5. Packianathan, N., Anusree, S. M & Manjunatha, B. (2016). The role of higher education in empowering Indian women. *International Journal of Health and Allied Sciences*, 5(3), 135-137 <https://www.ijhas.in/article.asp?issn=2278344X;year=2016;volume=5;issue=3;page=135;epage=137;aulast=Packianathan>
6. India Today. (September, 2021). NIRF Ranking 2021 full list: Check top 20 institutes in India, top 3 from every category. <https://www.indiatoday.in/education-today/news/story/nirf-ranking-2021-full-list-check-top-20-institutes-in-india-top-3-from-every-category-1850953-2021-09-09>
7. Higher Education in India (2022, March 12). In Wikipedia [https://en.wikipedia.org/wiki/Higher\\_education\\_in\\_India#History](https://en.wikipedia.org/wiki/Higher_education_in_India#History)
8. Mandal, P. The History of Women's Education in India. Your Article Library The Next Generation Library <https://www.yourarticlelibrary.com/education/the-history-of-womens-education-in-india/9982>
9. Moran, N. (2019). History of Female Education in Assam. *International Journal of Humanities and Social Science Invention*, 8(7), 40-42 [https://www.ijhssi.org/papers/vol8\(7\)/Series-1/H0807014042.pdf](https://www.ijhssi.org/papers/vol8(7)/Series-1/H0807014042.pdf)
10. Ministry of Education Department of Higher Education, Government of India. (2020). All India Survey on Higher Education (AISHE) 2019-2020. [https://www.education.gov.in/sites/upload\\_files/mhrd/files/statistics-new/aishe\\_eng.pdf](https://www.education.gov.in/sites/upload_files/mhrd/files/statistics-new/aishe_eng.pdf)



## Formulation and Characterization of Polymeric Nanoparticle of Antihypertensive Drug Bosentan

Subhasri Mohapatra<sup>1</sup>, Deepak Dash<sup>2</sup>, Manish R. Bhise<sup>3</sup>, Ashish Kandalkar<sup>4</sup>, Sanjay Vasu<sup>5</sup>, Sunny Pahuja<sup>6</sup> and Nitin S. Bhajipale<sup>7</sup>

<sup>1,2</sup>Royale College of pharmacy, Raipur, Chhattisgarh, India

<sup>3,5,6,7</sup>S.G.S.P.S Institute of Pharmacy, Akola (MS), India

<sup>4</sup>LSRG, Institute of Pharmacy, Akola, (MS), India

### ABSTRACT

Nanoparticles are colloidal particles with a size smaller than 1  $\mu\text{m}$ . The active compound can be present in various physical states; it can be dissolved in the polymeric matrix, can be encapsulated, or can be adsorbed or attached to the surface of the colloidal carrier. The term nanoparticles derive both nanocapsules and nanospheres. The objective of the study was to prepare and evaluate nanoparticle containing Bosentan in different polymer ratio. The drug and the polymer were used in five different ratios in the process of formulations. The nano-precipitation method was used to prepare nanoparticles so as to avoid both chlorinated solvents and surfactants to prevent their toxic effect on the body. The prepared nanoparticulate formulations of bosentan with different polymers in 1:1, 1:3, 1:5, 1:7 and 1:9 ratio have shown particle size in the range of ranging 120.1 nm to 184.0 nm, polydispersity index (PDI) in the range of 0.112 to 0.367, zeta potential in the range of -8.39 mV to -21.6 mV, The pH values of the nanoparticulate dispersions obtained ranged from 3.84 to 5.30. About 98% of drug release was seen in 22 hours for F3, whereas about 99% release was achieved and entrapment efficiency in the optimum range range 74.3%.

Keywords: Bosentan, nanoparticle, entrapment efficiency, *invitro* drug release.

### INTRODUCTION

It is often more difficult to distinguish between the different structures and morphologies of the types of nanoparticles; the term nanoparticles is thus used as a general term<sup>1</sup>. Polymeric nanoparticles are colloidal solid particles with a size range of 10 to 1000nm, spherical, branched or shell structures. The first fabrication of nanoparticles was made about 35 years ago with carriers for vaccines and cancer chemotherapeutics drugs, developed from non-biodegradable and biodegradable polymers. Their small sizes makes them to penetrable in the capillaries and to be taken up by cells, thereby ensuring the accumulation of drugs at target sites. Drugs are incorporated into nanoparticles by methods like dissolution, entrapment, adsorption, attachment or by encapsulation, and the nanoparticles provide sustained release of the drugs for longer periods, e.g., days and weeks. Such formulation enhance immunization by protecting degradation of the vaccine and increased uptake by immune cells<sup>1-3</sup>.

Polymer is One of the determinants of the extent of uptake by immune cells. In a study comparing poly( $\epsilon$ -caprolactone) (PCL), poly (lactide-coglycolide) (PLGA) and their blend, PCL nanoparticles were the efficient polymer taken up by immune cells due to their hydrophobicity. However, all polymeric nanoparticles elicited vaccine (diphtheria toxoid) specific serum IgG antibody response significantly higher than free diphtheria toxoid.<sup>4,5</sup> The drug can be conjugated to a tissue or cell specific ligand or coupled to macromolecules that reach the target organs. To target an anticancer agent to the liver, polymeric conjugate nanoparticles which comprised biotin and diamine-terminated polyethylene glycol with a galactose moiety from lactobionic acid were prepared. Some other applications of nanoparticles are possible recognition of vascular endothelial dysfunction; oral delivery of insulin; brain drug targeting for neurodegenerative disorders such as Alzheimer's disease; topical administration to improve penetration and distribution in and across the skin barrier; and pH-sensitive nanoparticles to improve oral bioavailability of drugs such as cyclosporine A.<sup>6-8</sup> Examples of some polymers used to formulate nps are chitosan, alginate, albumin, gelatin, polyacrylates, polycaprolactones, poly (D, L-lactide-co-glycolide) and poly (D, L-lactide) including cytotoxicity of by-products (although some, such as polyanhydrides, degrade into products that are biocompatible) and scalability. Certain drugs lack specificity at the target organs /sites. To overcome the problem drugs are to be selected for enhancing wellness, lessens sickness and provides better energy. Bosentan is under such category that facilitates reaching to the targeted sites with efficient concentrations. Bosentan is (4-tertbutyl-N-[6-(2-hydroxyethoxy)-5-(2-methoxyphenoxy)2-(pyrimidine-2-yl) pyrimidin-4-yl] benzene sulphonamide hydrate and is being used to treat pulmonary hypertension by blocking the action of endothelin molecules that would otherwise promote narrowing that

would otherwise promote narrowing of blood vessels and lead to high B.P. It is first approved by United states Food and Drug administration as tracer (125mg)<sup>9,10</sup>. This drug should not be stopped without consulting doctor as it may become worse. It can cause liver damage. It is a benzene-1- sulphonamide derivative & is a dual endothelin receptor antagonist indicated mainly in the management of pulmonary arterial hypertension. It is a highly water soluble drug having only 50% bioavailability with a terminal half-life of 5 hrs. It is a white crystalline powder, odourless powder, with a bitter taste<sup>11</sup>.

## **MATERIALS AND METHOD:**

### **Materials:**

Bosentan from Aurobindo pharmaceuticals, Hyderabad, India, PH 6.8 buffer in distilled water, acetone polymers e.g PLGA RG 503 H, PLGA RG 502 and PLA R 203; two stabilizers e.g Poloxamer 188 and Gelucire 44/14, were obtained from Central 12 Drug House, Mumbai, India. Distilled water was prepared in laboratory using all glass 15 distillation apparatus. UV Spectrophotometer (shimadzuuv 1800, japan) is used for the study. Particle size and polydispersity were determined by photon correlation spectroscopy (PCS) by using a Zetasizer 5000 (Malvern Instruments Ltd., UK).

### **Methods:**

#### **Formulation and optimization of Nanoparticle of Bosentan**

Nanoparticles was prepared by nanoprecipitation method which is based on preformed biodegradable polymers was followed. About 25-50 mg of the polymer was made a solution in 5 ml of a suitable organic solvent to form the diffusing phase. To this diffusing solution 5 mg of accurately weighed drug was added and dissolved completely. After this step 20-30 ml of purified water was taken in a clean beaker and 0.5-1.5% of a stabilizer was dissolved to form aqueous phase or the diffusion phase. Then the drug-polymer solution was injected into the non-solvent i.e., the aqueous phase. Two phases were mixed on the magnetic stirrer at 600 rpm to form a dispersion system. It is most important that the organic solvent was removed from the solution. So, it is made possible by keeping the dispersion system under reduced pressure on the rotary evaporation equipment<sup>12</sup>.

#### **Optimization of Process Variables:**

The effect of formulation such as stabilizer concentration, Concentration of the Organic Phase, ultrasonication, temperature, solvent ratio, stirring speed and drug polymer ratio etc have been studied in order to control and optimize the process<sup>12</sup>.

- (i) **Concentration of stabilizer:** To see the effect of concentration of stabilizer, Poloxamer 188 was used at 0.5%, 1% and 1.5%.
- (ii) **Different stabilizers:** Apart from Poloxamer 188, other stabilizers such as Polyvinylpyrrolidone K30 (2%), Polyvinylalcohol (0.2%), Gelucire 44/14 (0.5%) and Polyvinylalcohol (0.2%) in combination with Poloxamer 188 (0.5%) were used in the formulation of nanoparticles; to see their influence.
- (iii) **Organic Phase/Solvent:** Various water immiscible organic solvents/phases to dissolve the biodegradable polymer were used in the formulation to observe the effect on size of the nanoparticles. Acetone alone and in 1:1 combination with ethanol, chloroform and toluene, were used as the diffusing phase/solvent for drug-polymer solution.
- (iv) **Concentration of the Organic Phase:** The effect of concentration of organic phase i.e., acetone for the nanoprecipitation was evaluated.
- (v) **Ultrasonication:** The fine nanoparticulate dispersions were subjected to ultrasonication to see its effect.
- (vi) **Temperature:** The effect of temperature during the formulation of nanoparticles was observed.
- (vii) **Solvent (S) to Nonsolvent (NS) ratio:** The ratio/proportion of the solvent (S) and nonsolvent (NS) was varied to see the effect on nanoprecipitation of bosentan particles.
- (viii) **Stirring speed on the formation of nanoparticles:** While following the nanoprecipitation method the stirring speed was varied to observe the effect on the formation of nanoparticles.
- (ix) **Ratio/Proportion of drug and polymer:** The drug/polymer ratio was varied to see the effect on entrapment efficiency.

## CHARACTERIZATION OF NANOPARTICLES:

### Particle size analysis<sup>13</sup>

Particle size analysis The size distributions along the volume mean diameter of the nanoparticles and Zeta potential of all formulated nanoparticle was the range between were measured by laser scattering light using photon correlation spectroscopy using a Horiba Zetasizer Instruments.

### Entrapment efficiency:

The nanoparticles were first separated from the aqueous suspension medium by ultracentrifugation at 10000 rpm for 45 min. The amount of free drug in supernatant was measured by validated UV spectrophotometric method at 222 nm.<sup>14</sup> The drug entrapment efficiency (EE) of nanoparticles was determined in triplicate and calculated as indicated below:

$$\text{Entrapment Efficiency} = \frac{\text{Total amount of drug} - \text{Free drug}}{\text{Total amount of drug}} \times 100$$

### In-vitro drug release study:

The dialysis bag diffusion technique was used. 5 mL of the aqueous dispersions of the nanoparticles were placed in the dialysis bag (i.d. 22 mm, Mw cut off between 12000 to 14000), hermetically sealed and dropped into 200 ml of an aqueous environment. The receptor media used was phosphate buffer (pH 6.8) under sink conditions. The entire system was kept at 37°C with continuous magnetic stirring at 200 rpm. Samples (5 ml) were withdrawn from the receptor compartment at predetermined time intervals and replaced by fresh buffer. The amount of drug dissolved was determined by UV spectrophotometry at 222 nm<sup>15</sup>.

## RESULTS AND DISCUSSION:

Particle size and zeta potential of all the formulations are shown in Table 1. The particle size analysis was carried out using optical microscopy and zeta potential will be measured using Malvern instrument. It shows that all formulations provided particles in the range of 94.46 –198.7 nm, respectively. Increasing in the particle size observed with varying concentration of polymer in increasing order<sup>16</sup>.

**Table 1: Comparative Particle size and Zeta potential data of nanoparticulate formulations**

Formulations	Size (in nm) ± PDI	Zeta potential (mV)
F1	94.46 ± 0.390	-8.39 ± 6.62
F2	111.2 ± 0.287	-21.6 ± 9.79
F3	103.8 ± 0.211	-9.15 ± 6.35
F4	153.6 ± 0.669	-18.2 ± 4.38
F5	207.3 ± 0.129	-13.7 ± 7.3
F6	161.5 ± 0.422	-10.5 ± 8.33
F7	98.69 ± 0.176	-8.06 ± 8.31
F8	114.4 ± 0.145	-16.0 ± 10.7
F9	125.8 ± 0.107	-11.7 ± 7.29
F10	137.4 ± 0.131	-10.2 ± 7.04
F11	120.1 ± 0.367	-9.11 ± 5.23
F12	125.1 ± 0.200	-12.7 ± 8.91
F13	144.0 ± 0.144	-14.7 ± 7.84
F14	184.0 ± 0.118	-15.8 ± 7.69
F15	165.9 ± 0.112	-5.33 ± 17.1
F16	198.7 ± 0.138	-21.34 ± 6.43

The entrapment efficiency and drug content of different formulations are shown in Table 2. It shows that all formulations provided entrapment efficiency in the range of 35.8–75.3%.

**Table 2: Entrapment Efficiency of Formulated Nanoparticles**

Formulations	% Entrapment Efficiency
F1	35.8
F2	38.2
F3	42.6

F4	60.3
F5	67.2
F6	36.7
F7	39.3
F8	45.7
F9	59.3
F10	68.4
F11	39.3
F12	40.9
F13	46.7
F14	63.4
F15	75.3
F16	66.7
F17	69.5
F18	74.3

*In vitro* release studies for the nanoparticles of bosentan was performed using dialysis bag diffusion technique. The dialysis bag diffusion technique was used. 5 mL of the aqueous dispersions of the nanoparticles were placed in the dialysis bag (i.d. 22 mm, Mw cut off between 12000 to 14000), hermetically sealed and dropped into 200 ml of an aqueous environment. The receptor media used was phosphate buffer (pH 6.8) under sink conditions. The entire system was kept at 37°C with continuous magnetic stirring at 200 rpm. Samples (5 ml) were withdrawn from the receptor compartment at predetermined time intervals and replaced by fresh buffer<sup>17</sup>. The amount of drug dissolved was determined by UV spectrophotometry at 222 nm. Dissolution data of F3, F4, F5 are shown in Table 3.

**Table 3: Dissolution data of Formulations F3, F4, F5**

Time (in hr)	% Cumulative Drug Release F3	% Cumulative Drug Release F4	% Cumulative Drug Release F5
0	0	0	0
0.25	9.321	7.326	7.17948
0.5	13.976	10.345	9.973
1	16.2769	13.894	12.784
2	21.02432	17.546	15.543
3	31.19738	25.737	23.629
4	37.30122	30.654	28.731
6	42.04865	34.957	33.409
8	48.15248	40.473	41.391
10	59.20721	52.987	50.152
12	64.345	58.345	56.348
18	86.564	82.568	80.641
20	92.346	85.67	83.265
22	98.434	92.313	90.324
24	99.187	98.65	99.482

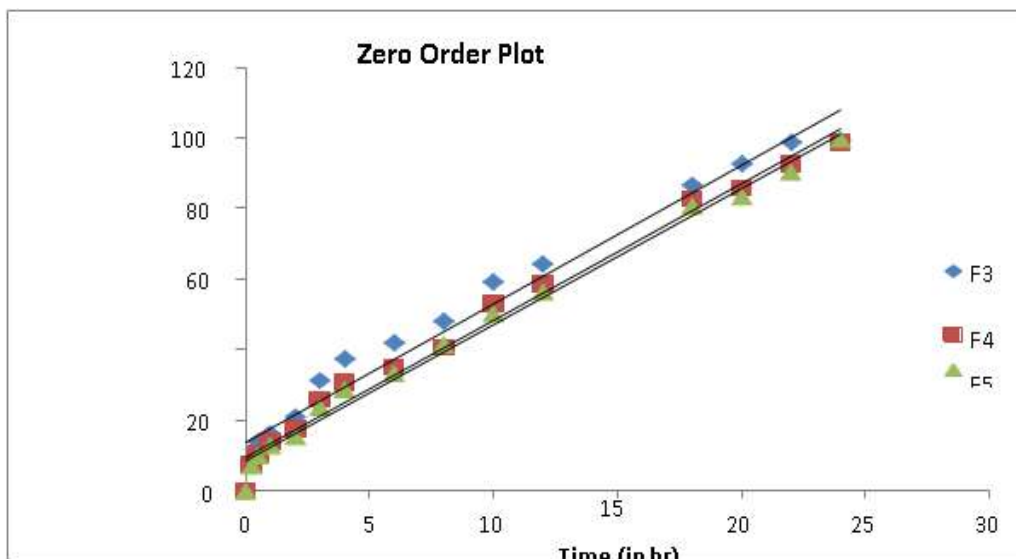


Fig.(1): Dissolution profile for F3, F4 and F5

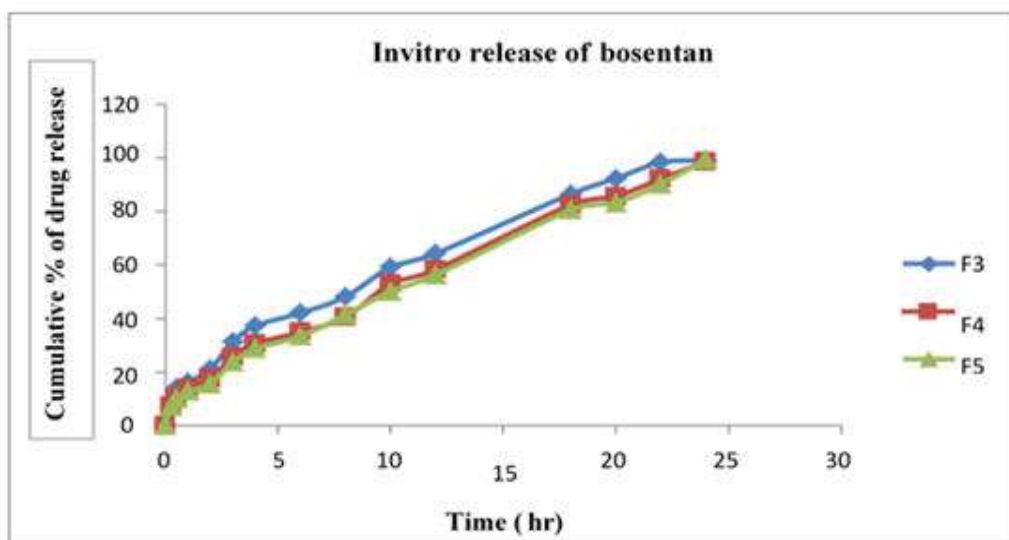


Fig. (2): Zero order plot for F3, F4 and F5

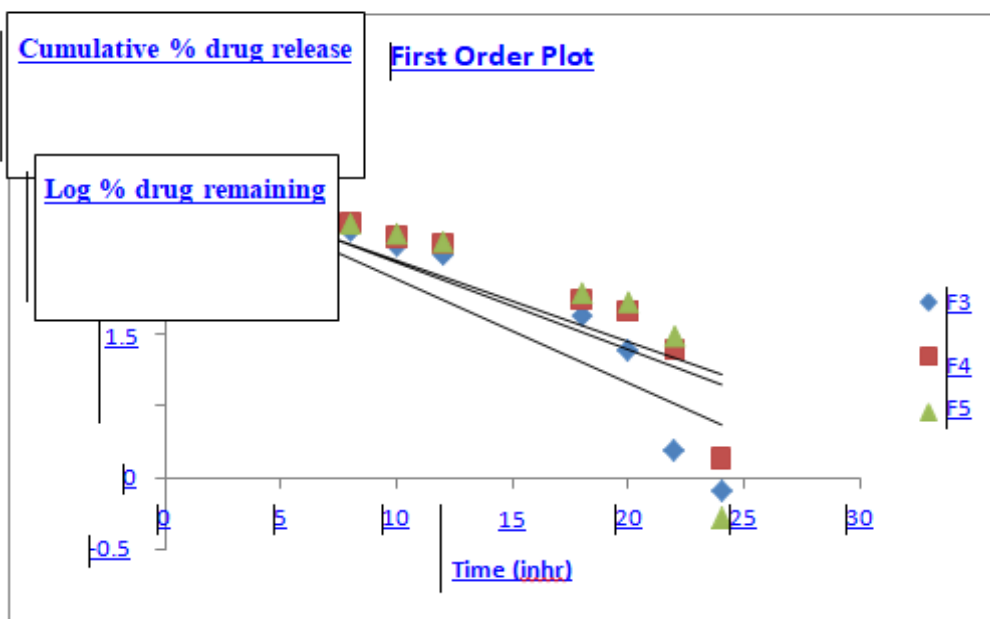


Fig. (3): First order plot for F3, F4 and F5

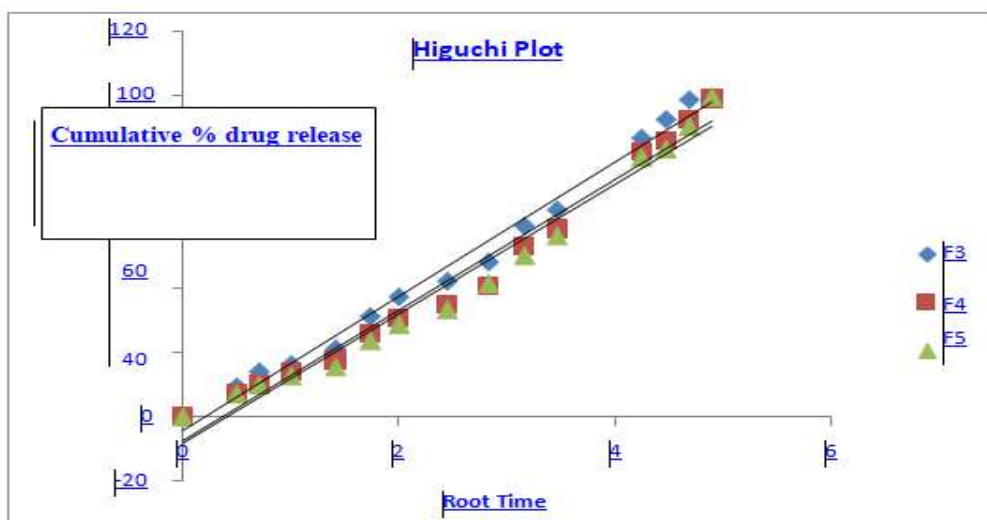


Fig. (4): Higuchi plot for F3, F4 and F5

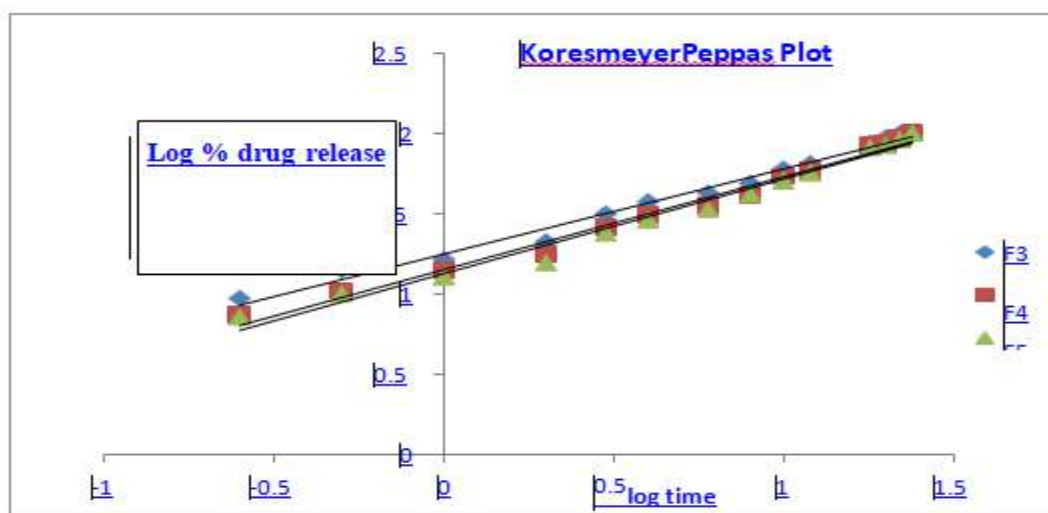


Fig. (5): KoresmeyerPeppas plot for F3, F4 and F5

Table (4.): Illustrative data of various kinetic models for F3, F4 and F5

Formulations	Zero Order (R <sup>2</sup> )	First Order (R <sup>2</sup> )	Higuchi (R <sup>2</sup> )	Koresmeyer-Peppas (n)
F8	0.98	0.93	0.99	0.54
F9	0.99	0.92	0.98	0.57
F10	0.99	0.86	0.98	0.57

The results are noted in Table (3) and shown in Fig. (1-5). For formulations F3 to F5 in case of polymer PLGA 503 H with Poloxamer 188 as the stabilizer. The formulations displayed a sustained release profile with no initial burst effect with increased polymer concentration, the drug release decreased which could be due to retardation at higher viscosity. About 98% of drug release was seen in 22 hours for F3, whereas about 99% release was achieved in 24 hours in case of F4 and F5. At the end of 12 hours, 64%, 58% and 56% drug release from F3, F4 and F5 respectively. Analysis of drug release data from various plots such as Zero order, First order, Koresmeyer-Peppas plot and Higuchi plot; it could be inferred that the drug release followed Zero order kinetics, non-Fickian anomalous diffusion mechanism as well as showed good correlation with square root of time indicating the drug release mechanism to be diffusion controlled.

### 3.4 Nanoparticle morphology

The nanoparticle surface appearance and shape were analysed by SEM. Samples were prepared by finely spreading concentrated nanoparticle dispersions over slabs and by drying them under vacuum. The samples were then coated in a cathodic evaporator with a fine gold layer and observed by SEM using a JSM-6400 scanning electron microscope. 16.

### 3.5 Short-term Stability Study

The formulated nanoparticulate dispersions of bosentan were kept under refrigeration (2-8°C) conditions, in well closed glass containers for a period 2 months. All the formulations were tested for particle size and zeta potential.

### 3.6 Drug-Excipient Compatibility:

A drug or active principle was most often delivered to a patient along with other chemical substances within a pharmaceutical formulation, which should comply with strict specification, often prescribed by law. In order to be approved a formulation should warrant well defined level of stability. Interaction between drug and excipient occur by several mechanisms including adsorption, complexation, chemical interaction, pH effect, and eutectic formation, resulting in drug products with desired or undesired properties. This is performed by using FT-IR spectroscopic analysis method and spectra were compared with reference.

### CONCLUSION

In this research work, we synthesize nanoparticles system for bosentan, a benzene -1- sulfonamide derivative, which is a dual endothelin receptor antagonist indicated mainly in the management of pulmonary arterial hypertension. Bosentan is a highly water insoluble drug, having only 50% bioavailability, with a terminal half-life of 5 hrs. Stable nanoparticulate dispersions/systems of bosentan can be formulated employing biodegradable polymers, with fairly good entrapment efficiency and controlled release upto 24 hours. However, there is scope to extend the investigations to in vivo studies, long-term stability tests, toxicity testing, scale-up and other studies.

### REFERENCE

1. Sarkar R, Kumbhakar P, Mitra AK, Ganeev RA. Synthesis and photoluminescence properties of silver nanowires. *Curr Appl Phys.* 2010; 10:853–857.
2. Dieter V, Fischer, Dieter F, David H. Surface energy of nanoparticles influence of particle size and structure. *Beilstein Journal of Nanotechnology.* 2018; 9:2265-2276. DOI:10.3762/bjnano.9.211. PMC 6122122. PMID 30202695.
3. Michelakaki I, Boukos N, Dragatogiannis DA, Stathopoulos S, Charitidis CA, Tsoukalas D. Synthesis of hafnium nanoparticles and hafnium nanoparticle films by gas condensation and energetic deposition. *Beilstein Journal of Nanotechnology.* 2018; 9: 1868–1880. DOI: 10.3762/bjnano.9.179. PMC 6036986. PMID 30013881.
4. Wei C, Nix WD. *Imperfections in Crystalline Solids.* Cambridge Core. 2016. DOI: 10.1017/cbo9781316389508. ISBN 9781107123137.
5. Silvera Batista CA, Larson RG, Kotov NA. Nonadditivity of nanoparticle interactions. *Science.* 2015; 350(6257): 1242477. doi:10.1126/science.1242477. PMID 26450215.
6. Noh SY, Nash A, Notman R. The aggregation of striped nanoparticles in mixed phospholipid bilayers. *Nanoscale.* 2020; 12 (8): 4868–81. DOI: 10.1039/c9nr07106g. PMID 31916561. S2CID, 210119752.
7. Stephenson C, Hubler A. Stability and conductivity of self assembled wires in a transverse electric field. *Sci. Rep.* 5: 15044. DOI: 10.1038/srep15044. PMC 4604515. PMID 26463476.
8. Omidvar A. Metal-enhanced fluorescence of graphene oxide by palladium nanoparticles in the blue-green part of the spectrum. *Chinese Physics B.* 2016; 25 (11): 118102. Bibcode: 2016ChPhB..25k8102O. DOI:10.1088/1674-1056/25/11/118102.
9. Singh BN, Prateeksha, Gupta VK, Chen J, Atanasov AG. Organic Nanoparticle-Based Combinatory Approaches for Gene Therapy. *Trends Biotechnol.* 2017; 35 (12): 1121–1124. DOI:10.1016/j.tibtech.2017.07.010. PMID 28818304.
10. Goshtasp C, Wistuba, Michael P. Ultraviolet aging study on bitumen modified by a composite of clay and fumed silica nanoparticles. *Scientific Reports.* 2020; 10 (1): 11216. Bibcode:2 020NatSR..1011216C. DOI: 10.1038/s41598-020-68007-0. PMC 7343882. PMID 32641741.
11. Hanagata N, Morita H. Calcium ions rescue human lung epithelial cells from the toxicity of zinc oxide nanoparticles. *The Journal of Toxicological Sciences.* 2015; 40 (5): 625–35. DOI:10.2131/jts.40.625. PMID 26354379.

12. Campbell, Charles T. The Energetics of Supported Metal Nanoparticles: Relationships to Sintering Rates and Catalytic Activity. *Accounts of Chemical Research*. 2013; 46 (8): 1712–1719. DOI: 10.1021/ar3003514. ISSN 0001-4842. PMID 23607711.
13. Mishra SS, Sharma A. Preparation and Characterization of Chitosan Nanoparticles of Insulin for Nasal Delivery. *Journal of Drug Delivery & Therapeutics*. 2018; 8(5-s): 400-406. DOI:10.22270/jddt.v8i5-s.2002
14. Shelake SS, PatilSV, PatilSS, SangaveP. Formulation and Evaluation of Fenofibrate-loaded Nanoparticles by Precipitation Method. *Indian J Pharm Sci* 2018;80(3): 420-427. DOI: 10.4172/pharmaceutical-sciences.1000374
15. Charanteja Reddy Y, Jeganath S, Muni Kumar U. Formulation and Evaluation of Chitosan Nanoparticles for Improved Efficacy of Itraconazole Antifungal Drug. *Asian J Pharm Clin Res*, Vol 11, Special Issue 4, 2018, 147-152. DOI: <http://dx.doi.org/10.22159/ajpcr.2018.v11s4.31723>
16. Simakov SK. Nano- and micron-sized diamond genesis in nature: An overview. *Geoscience Frontiers*. 2018; 9(6): 1849–1858. DOI:10.1016/j.gsf.2017.10.006.
17. Sadiq MA, Bahaidarah HMS. Numerical Study on Generalized Heat and Mass in Casson Fluid with Hybrid Nanostructures. *Nanomaterials*. 2021; 11(10):2675. <https://doi.org/10.3390/nano11102675>.



## Synthesis of derivatives of Chlorosubstituted Flavone and Effects of Chlorosubstituted derivatives of Flavone on some Kharif Crop Plants

S.G. Kalane<sup>1</sup>, B. K. Dhotre<sup>2</sup> and S. P. Rathod<sup>3</sup>

<sup>1</sup>Department of Chemistry, Late Pundalikrao Gawali Arts & Science Mahavidyalay, Shirpur Jain, Dist. Washim (M.S.) India

<sup>2</sup>Department of Chemistry, Swami Vivekanand Sr. College Mantha, District Jalna (M.S.) India

<sup>3</sup>Department of Chemistry, G.S.G. Mahavidyalay, Umarched. Dist. Yavatmal (M.S.) India

### ABSTRACT

The majority of farmers cultivate Kharif crop in the tropical region and has been experimenting with some crop like Soybean, Moong and Urad, etc., as a source of their economy. A literature survey reveals that the utility of chlorosubstituted Flavones in the field of agricultural science and pharmaceutical science is ever increasing. Due to their importance in the field of agriculture as plant growth regulating agents, we study the efficiency of newly synthesized chlorosubstituted Flavones viz. 3-(4-methoxybenzoyl)-2-(4-Chloro phenyl) flavone and 3-(4-chlorobenzene)-2-(4-chlorophenyl) flavone in the light of their significance towards the growth-promoting impact on Kharif crop. The results obtained in the present study are very encouraging.

Keywords: Kharif crop, Chlorosubstituted Flavone, Growth promoting agents.

### INTRODUCTION

Flavones are class of flavonoids based on the backbone of 2-phenylchromen-4-one (2-phenyl-1-benzopyran-4-one). Flavones are considerable attention towards agriculture field [1]. Some substituted flavones were reported to a various biological activity [2-9]. Central India i.e. tropical region farmers are engaged in the cultivation of Kharif crops but yield not satisfactory with their efforts. Literature survey reveals that, Chlorosubstituted flavones have enormous importance in the field of agriculture sector as plant growth regulating agents. Many medicinal and agricultural chemists interested in the synthesis of flavone derivatives for growth promoting agents and improved properties towards respective fields [10]. Chalcones and their derivatives containing  $\alpha$ ,  $\beta$  unsaturated carbonyl group are active ingredients for the progress of various reactions and physiologically active compound [11]. The present study to synthesize and efficacy of some chlorosubstituted flavones viz. 3-benzoyl-2-(4-Chloro phenyl)-4-chloro phenyl flavone and 3-benzoyl-2-(4-Chloro phenyl)-4-methoxy phenyl flavone with special reference to their use as growth promoting agents for some Kharif crops viz. Soybean, Moong and Udit.

### EXPERIMENTAL

All solvents and reagents were picked up since Merck India Ltd and are of AR Grade and recycled without further purification. Melting Points were unwavering by the open capillary method and were uncorrected. Thin-layer chromatography (TLC) was implemented on silica. The spots were visualized by exposure to iodine vapor. Nuclear magnetic resonance (NMR) spectra were recorded on a 400-MHz spectrometer for <sup>1</sup>H NMR. IR spectra of the compounds accomplished in potassium bromide (KBr) disks on a Bruker IR spectrometer. Mass spectra were recorded on a Waters ZQ-4000 spectrometer. The yields of the synthesized compounds were revealed for the isolated product. The analytical and spectral data of compounds were highly satisfactory.

#### Preparation of 2-acetyl phenyl 4-chlorobenzoate (3a):

Starting from o-hydroxy acetophenone (0.05 mol) (1a), p-chlorobenzoyl Chloride (0.05 mol) (2a) suspended in NaOH (10%) (30 ml) in 500 ml Round Bottom Flask with cork. This reaction mixture was shaken for 45 min. After shaking reaction mixture was poured in 500 ml separating funnel. The favorable product was separated, filtered and washed with the help of Sodium bicarbonate (10%). The reaction mixture was washed with water. Recrystallized with the absolute ethanol. M.P. 67<sup>o</sup> C, yield 78%.

#### Preparation of 1-(4-chlorophenyl)-3-(2-hydroxyphenyl) propane-1,3-dione (4a):

2-acetyl phenyl 4-chlorobenzoate was suspended in dry pyridine (40ml) in 100 ml RBF. The solution warmed up to the temperature of 60<sup>o</sup> C. Then Pulverized KOH (15 gm) was added with constant stirring at room temperature. Completion of reaction mixture was monitored by using TLC plate. After four hours of heating, the reaction mixture was acidified with adding ice-cold dil. HCl (1:1). The brownish-yellowish solid product was separated, filtered and washed with sodium bicarbonate (10%). Then wash with again cold water. Recrystallized using ethanol acetic acid mixture to acquire 1-(4-chlorophenyl)-3-(2-hydroxyphenyl) (4a), m.p. 111<sup>o</sup> C, yield 76%.

**Preparation of 3-(4-chlorobenzoyl)-2-(4 Chloro phenyl) flavanone (5a):**

1-(4-chlorophenyl)-3-(2-hydroxyphenyl) propane-1,3-dione (0.01 mol) mixed with 4-chlorobenzaldehyde (0.01 mol) in 25 ml of ethanol and piperidine (0.5 mol) in the 100 ml RBF. It was refluxed for 20 min. Progress of reaction was monitored by using a TLC plate. After the completion of the reaction, the reaction mixture was cooled to room temperature. It was acidified with dil. HCl (1:1) and the desired product was separated. Recrystallize from ethanol-acetic acid mixture to get product. M.p. 142 °C, yield 78% (5a).

**Preparation of 3-(4-chlorobenzoyl)-2-(4-chlorophenyl) flavone (6a):**

A mixture of 3-benzoyl-2-(4 chloro phenyl)-4-chlorophenyl flavanone (6a) (0.01 mol) and iodine crystal was refluxed in DMSO (20 ml) for about 10 min. in 100 ml RBF. Progress of the reaction was monitored by using a TLC plate. After completion of reaction, the reaction mixture cooled to the room temperature. The solid product was obtained and separated. It was washed with sodium thiosulphate solution. Finally recrystallize from ethanol acetic acid mixture to get the 3-(4-chlorobenzoyl)-2-(4-chlorophenyl) flavone. (M.p. )131 °C. yield 80%.

**Preparation of 2-Aceto phenyl-4-methoxybenzoate (3b):**

Starting from o-hydroxy acetophenone (0.05 mol) (1b), anisic acid (0.05 mol) (2b) were suspended in dry pyridine (40 ml) and to this POCl<sub>3</sub> (3 ml) was added drop wise with constant stirring and cooling. This reaction mixture was kept overnight and then worked up by dilution and acidification with ice cold HCl (1:1) to neutralize pyridine. The solid product thus obtained was filtered, washed with water followed by Sodium bicarbonate (10%). The reaction mixture was Raines with water. Recrystallized from absolute ethanol. M.P. 67 °C, yield 78%.

**Preparation of 1-(2-hydroxy phenyl)-3-(4'-methoxyphenyl)-1,3-propadione (4b):**

2-Aceto phenyl-4-methoxybenzoate (3b) (0.05 mol) was suspended in dry pyridine (40 ml). The solution was warmed up to the 60 °C and pulverized KOH (15 gm) added slowly with constant stirring. After four hours the reaction mixture was acidified with ice cold dil. HCl (1:1) . The solid product was separated and washed with sodium bicarbonate (10%). Then wash with cold water. Recrystallized using absolute ethanol to get 1-(2-hydroxy phenyl)-3(4'-methoxyphenyl)-1,3-propadione (4b), m.p. 115 °C, yield 76%.

**Preparation of 3-(4-methxybenzoyl) -2 (4- Chloro phenyl ) flavanone (5b):**

A mixture of 1-(2-hydroxy phenyl)-3(4'-methoxyphenyl)-1,3-propadione (4b) (0.01 mol) and 4-chlorobenzaldehyde (0.01) was refluxed in ethanol (25 ml) and piperidine (0.5 ml) for 20 min. After cooling, the reaction mixture was acidified with dil. HCL (1:1) and the product thus separated, was crystalized in absolute ethanol to get ,3-(4-methxybenzoyl) -2 (4- Chloro phenyl ) flavanone(5b), m.p. 150 °C, yield- 74%.

**Preparation of 3-(4-methxybenzoyl) -2 (4- Chloro phenyl) flavone (6b):**

3-(4-methxybenzoyl) -2 (4- Chloro phenyl) flavanone (5b) (0.01 mol) and iodine crystal was refluxed in DMSO (20 ml) for about 10 min. in 100 ml RBF. Progress of the reaction was monitored by using a TLC plate. After completion of reaction, the reaction mixture cooled to the room temperature. The solid product was obtained and separated. It was washed with sodium thiosulphate solution. Finally recrystallize from absolute ethanol to get the 3-(4-methxybenzoyl) -2 (4- Chloro phenyl) flavone (6b) , M.p. 119 °C, yield- 77%.

**RESULT AND DISCUSSION:**

We have synthesized first series a chlorosubstituted flavone derivative (6a) by flavanone drivatives which as prepared by cyclisation of 1-(4- chlorophenyl)-3-2 hdroxyphenyl (4a) with chlorobenzladehyde by using a catalytic amount of piperidine under solvent of ethanol. Starting from o-hydroxy acetophenone treated with p-chlorobenzoyl chloride in presence of NaOH to obtain 2-acetyl phenyl 4-chlorobenzoate by literature method [12]. 1-(4-chlorophenyl)-3-(2-hydroxyphenyl) propane-1,3-dione was obtained by 2-acetyl phenyl 4-chlorobenzoate under catalytic amount of BVT in Pyridine by using potassium hydroxide. The synthesized compound purified by recrystallization in absolute ethanol. The synthesized compound is characterized by various techniques like <sup>1</sup>H-NMR, IR and mass. Compound 6a confirmed by NMR peaks of aromatics proton appears δ 6.1-6.6 as multiplet. IR absorption band appears at 3435 cm<sup>-1</sup> for aromatic proton. band appears at 1523 cm<sup>-1</sup> indicates -C=O group while band appears at 814 cm<sup>-1</sup> and 1016 cm<sup>-1</sup> Ar-Cl stretching. GC-MS spectra shows at m/z 396.

We have also synthesized second series of a methoxysubstituted flavone derivative (6b) by flavanone drivatives which as prepared by cyclisation of 1-(4- methoxyphenyl)-3-2 hdroxyphenyl (4a) with chlorobenzladehyde by using a catalytic amount of piperidine under solvent of ethanol. Starting from o-hydroxy acetophenone treated with anisic acid in presence of POCl<sub>3</sub> to obtain 2-acetyl phenyl 4-methoxybenzoate by literature method [12]. 1-(4-methoxyphenyl)-3-(2-hydroxyphenyl) propane-1,3-dione was obtained by 2-acetyl phenyl 4-

methoxybenzoate under catalytic amount of BVT in Pyridine by using potassium hydroxide. The synthesized compound purified by recrystallization in absolute ethanol. The synthesized compound is characterized by various techniques like <sup>1</sup>H-NMR, IR and mass. Compound 6a confirmed by NMR peaks of aromatics proton appears δ 6.5-6.9 as multiplet. IR absorption band appears at 3412 cm<sup>-1</sup> for aromatic proton. band appears at 1599 cm<sup>-1</sup> indicates -C=O group while band appears at 854 cm<sup>-1</sup> and 1030 cm<sup>-1</sup> for Ar-Cl and OCH<sub>3</sub> stretching respectively. GC-MS spectra shows at m/z 379.

#### Spectral data of Chlorosubstituted flavone derivatives:

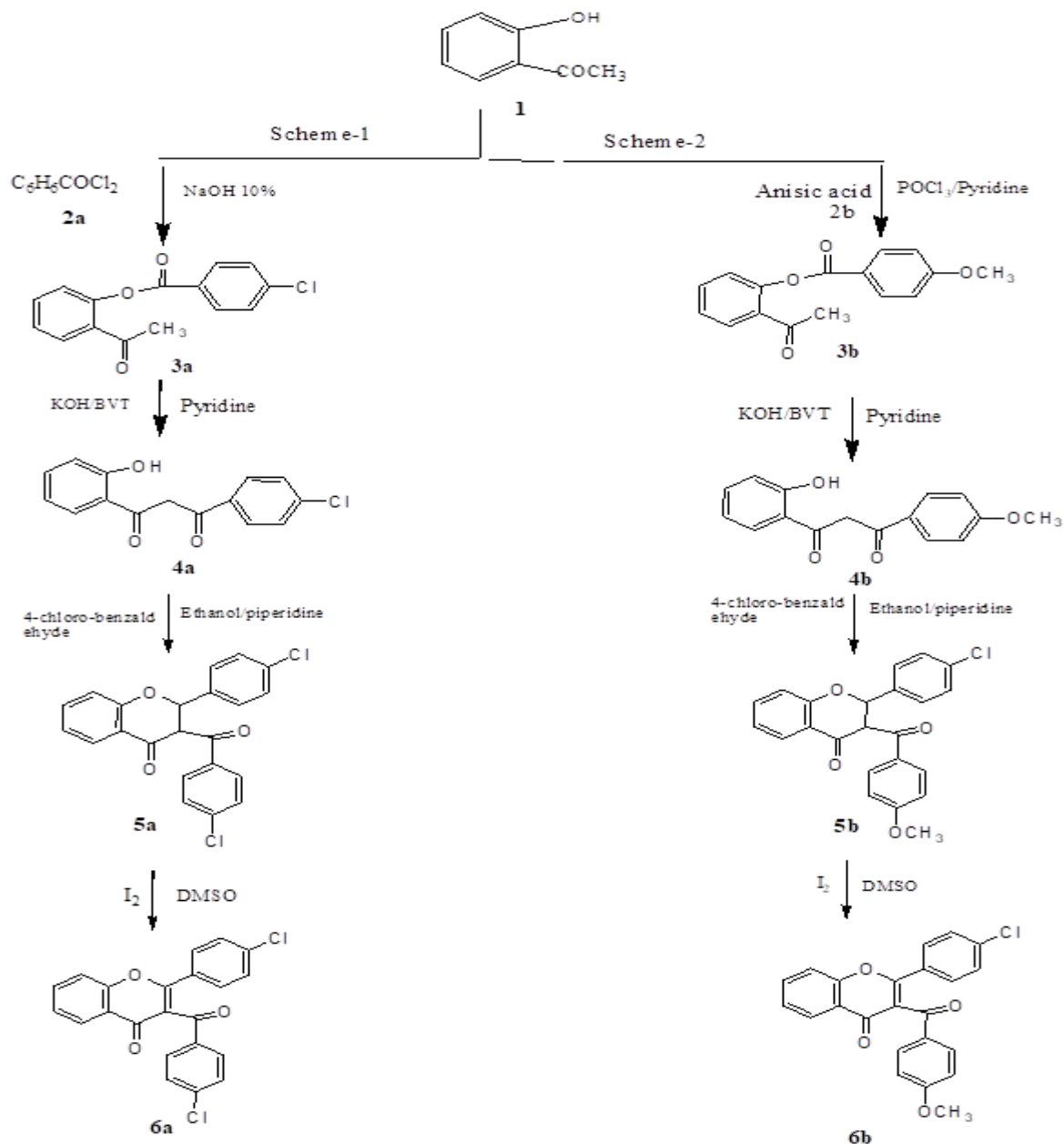
##### 3-(4-chlorobenzoyl)-2-(4-chlorophenyl) flavone (6a):

Molecular formula: C<sub>22</sub>H<sub>12</sub>O<sub>3</sub>Cl<sub>2</sub> yield:76%, m.p. 131<sup>o</sup>C. IR (KBr) cm<sup>-1</sup>: 3435 (-CH Aromatic str), 1523 (>C = O str), 814 (Ar-Cl), 1016 (Ar-Cl); <sup>1</sup>H NMR (DMSO-d<sub>6</sub>), 400 MHz, δ (ppm) 6.1 (d, 1H), 6.3 (m, 3H), 6.4 (dd, 2H), 6.5(d, 1H), 7.01(m, 3H), 9.1 (d, 1H)., mass: 395 (M+1).

##### 3-(4-methoxybenzoyl) -2 (4- Chloro phenyl) flavone (6b):

Molecular formula: C<sub>22</sub>H<sub>15</sub>O<sub>4</sub>Cl yield: 74%, m.p. 119<sup>o</sup>C. IR (KBr) cm<sup>-1</sup>: 3412(-CH Aromatic str), 1599 (>C = O str), 854 (Ar-Cl), 1113 (Ar-OCH<sub>3</sub>); <sup>1</sup>H NMR (DMSO-d<sub>6</sub>), 400 MHz, δ (ppm) 6.5 (d, 4H), 6.9 (d, 2H), 7.7 (d, 2H), 7.9(d, 2H), 9.7 (d, 1H)., mass: 379 (M+1).

The compound (3a-6a) and (3b-6b) were studied the vegetative growth promoting effects of some newly synthesized chlorosubstituted flavones with special reference to kharif crops.



**For growth promoting effects:**

The beds cotton soil, 2.5 x 2.5-meter size prepared on an open field of the small plants of Soybean, Moong and Urad is cultivated.

The seeds of all three species Soybean, Moong and Urad has taken under examination were sowed in these beds separately by conventional method. The plant beds were irrigated with tap water. The seeds of Soybean, Moong and Urad kept in solutions of newly synthesized chlorosubstituted flavones were prepared in (0.01 dilution) separately overnight and sprayed thrice at fortnightly intervals (15, 30, 45 days). The seeds from each bed were divided in to two groups (A) and (B). The group (A) seeds were not kept in solution overnight and unsprayed termed as control group. Whereas the seeds from group (B) designated as treated group these seeds were kept in solution and sprayed with the compounds being tested.

All the filed experiments were conducted to compare the treated seeds and control seeds. The samples were taken at 15, 30, 45, 60, 75 and 90 days after planting stage. The plants were carefully examined and number of leaves and heights of shoots were recorded (Table-2a-2b). The data obtained was subjected to analysis of growth parameters.

**Table-2a:** Effect of newly synthesized compound: **3-(4-chlorobenzoyl)-2-(4-chlorophenyl) flavone (6a):** on the growth of Kharif crop.

Days	Soyabean				Moong				Urad			
	No.of leaves		Shoot Hight (Cm)		No.of Leaves		Shoot Hight (Cm)		No.of leaves		Shoot Hight (Cm)	
	C	T	C	T	C	T	C	T	C	T	C	T
15	7	9	8.1	11	5	8	7	10	4	7	6	9
30	13	16	15	18	9	13	12	14	8	11	10	12
45	29	34	24	28	18	22	21	24	19	23	18	20
60	48	52	31	36	27	31	29	32	32	35	25	27
75	60	64	33	39	34	38	60	64	41	45	29	31
90	66	70	36	41	62	66	33	38	55	60	31	33

Note: C = Control, T = Treated

**Table-2b:** Effect of newly synthesized compound: **3-(4-methxybenzoyl) -2 (4- Chloro phenyl) flavone (6b):** on the growth of Kharif crop.

Days	Soyabean				Moong				Urad			
	No.of leaves		Shoot Hight (Cm)		No.of Leaves		Shoot Hight (Cm)		No.of leaves		Shoot Hight (Cm)	
	C	T	C	T	C	T	C	T	C	T	C	T
15	7	9	6	8	7	9	5	8	6.2	8	4	7
30	11	14	14	17	10	13	11	13	9	11	8	11
45	22	26	23	26	24	27	17	20	16.4	22	16	19
60	28	31	34	36	30	33	26	29	24	27	25	30
75	31	33	47	50	32	35	39	41	29	31	38	46
90	34	36	56	61	34	37	54	61	31	33	49	64

Note: C = Control, T = Treated

The synthesized compounds were screened for their growth-promoting activity on Kharif crop. The plants were used as *Soybean, Moong, and Urad*. Efforts have been made to examine and study the morphology of treated plants

The choice of these crops was based on their enormously vast utility and also the indispensability for the survival of the human race, all across the globe. Efforts have been made to investigate and analyze the convergence and divergence effect of test compounds on the morphology of plants under investigation. It was interesting to note that, all the treated seeds exhibited remarkable leaves and shoot elongation as compared to untreated ones.

When the growth of all the treated plants were compared among themselves, it was distinctly observed that, the change which is dominant while applying the treated compound i.e. chlorosubstituted flavanones in *Soybean, Moong, and Urad*. In the initial stage, vegetative growth was not significant but after 2<sup>nd</sup> interval, it gradually increases, and after 15 days leaves and shoot elongation was dominant to a considerable extent. In this

experiment 6a compound gives promising effect as compared to 6b compound. Thus there has been a fair amount of satisfaction in crying out the present study. The encouraging results have surely contributed to the enthusiasm of the author. But honestly, this is just the beginning. There is much scope for further study, and there is a long way to go.

#### ACKNOWLEDGEMENTS

We are thankful to Gopikabai Sitaram Gawande Mahavidyalaya, Umardhed and Late Pundalikrao Gawali Mahavidyalaya, Shirpur Jain for providing research facilities. We are also thankful to ICT, Hyderabad, and Yeshwant Mahavidyalaya, Nanded for providing the spectral and analytical data.

#### REFERENCES

1. R.T. Parihar, S.P. Rathod, P.R. Rajput, *Rasayan J. Chem.* 4(3), 660-665 (2011).
2. A.M. Osman and K.M. Hasan, *Indian J. Chem.* 14 B. 282 (1954).
3. Z.H. Khalil and A.S. Yanni, *J. Ind., Chem.Soc.* 58.168 (1981).
4. J.M. Rashdi and N.S. Habib, *Chem. Abstr.* 89, 163490J (1978).
5. N.K. Mandal and K.P. Banerjee, *Chem. Abstr.* 104, 34034V (1986).
6. M.D. Ankhivala and K.B. Naik, *Chem. Abstr.* 112, 5561 (1990).
7. S.V. Damle and P.R. Muley, *Indian J. Heterocyclic Chem.*, 9, 8(1999).
8. R. Kaliranjan., L. Rathore., S. Jubie., S. Sankar., *Indian J. Chem.*, 50B, 1794-1799(2011).
9. J. Rajora., J. Yadav., R. Kumar., Y.K. Srivastava, *Indian J. Chem.*, 49B, 989-993(2010).
10. N.G. Ghodile., P.R. Rajput and P.P. Rajput., *International journal of Applied and Pure Science and Agriculture*, 2(7), 2394-5532(2016).
11. V.J. Husare., P.R. Rajput., N.G. Ghodile and M.O. Malpani., *International Journal of Pharmtech Research.*, 5(2), 420-425., 0974-4304(2013).
12. O.P. Agrawal *Organic Chemistry Reaction and Reagents*, 32<sup>nd</sup> Ed, Goel Publishing House, Meerut, India p.493(2003).

## **A Study on Employee Inclusion of Squarefoodmeal Pvt Ltd among Speech and Hearing Impairment (SHI) Individuals in Mumbai**

**Rhutula Jadhav**

Guru Nanak Institute of Management Studies, Mumbai, Maharashtra

### **ABSTRACT**

Speech and Hearing Impairment individuals look normal and hence they have more social acceptability and connection is higher among people. Sign Language has been used to indicate by all individuals to convey emotions and express ourselves better than any words would ever do. Hence Interacting with SHI individuals becomes easier by learning sign languages. This Paper creates awareness about implications of reverse inclusion in work settings.

Keywords:- Speech and Hearing (SHI) Impairment ,Inclusion, Workforce

### **INTRODUCTION**

There are nearly 6.5 million Speech and Hearing Impaired (SHI) people in India, with only 15-20% of them working. Many are treated as dependents in their households.

Being speech-and-hearing-impaired (SHI) has been a significant barrier for many young people in finding work, primarily because workplaces are not equipped to assist and support SHI employees.

Squaremeals food Pvt ltd India, on the other hand, has made special efforts to ensure that workplaces are inclusive and that every individual can find professional growth.

Squaremeal Foods was founded to carry out the vision of establishing a chain of 21 restaurants offering cutting-edge, well-thought-out, and evolved food, while also developing capabilities in people who are deaf or hard of hearing. And in response, like-minded investors stepped forward, putting their hearts and hands together. Squaremeal Foods' first restaurant, Mirchi & Mime, opened in May 2015, serving modern-Indian cuisine, and their second, Madeira & Mime, opened in October 2016, a pub serving world cuisine comfort food.

"Reverse integration" refers to the phenomenon in which able-bodied Employees ( few in numbers ) join employees with disabilities ( more in numbers).

### **LITERATURE REVIEW**

This research paper current framework is disability research, which encompasses biological, psychological, social, and cultural aspects of functioning, impairment, and disability (Danermark & Gellerstedt, 2004b). Traditionally, disability research has been conducted using medical and social theoretical models. One limitation of using either model separately is that neither can provide a comprehensive view of disability. In the current study, functioning and disability are viewed as a result of an interaction between an individual's health status, as well as contextual and personal factors (WHO, 2001). When conducting interdisciplinary disability research, many decisions must be made (e.g., methods, what to study, under what conditions, and so on)

The American Annals of the Deaf is a professional journal dedicated to quality education and related services for deaf or hard of hearing children and adults. First published in 1847, the Annals is the oldest and most widely read English-language journal dealing with deafness and the education of deaf persons. The Annals is the official organ of the Council of American Instructors of the Deaf (CAID) and of the Conference of Educational Administrators of Schools and Programs for the Deaf (CEASD) and is directed and administered by a Joint Annals Administrative Committee made up of members of the executive committees of both of these organizations.

### **OBJECTIVES OF THE STUDY:**

To Study the Employee inclusion among Speech and Hearing Impairment (SHI) individuals

To understand the impact of reverse inclusion at workplace

### **RESEARCH METHODOLOGY**

"Research design is the conceptual structure within which research is conducted. Research design indicates the blue print for the collection, measurement and analysis of data. The design includes an outline of what the researcher plans and frames the research work. It explains how samples are selected, sample size determined, how data is collected, and which statistical methods are used for data analysis". Qualitative Research means

Data from first-hand observation, interviews, questionnaires, focus groups, participant-observation, recordings made in natural settings, documents, and artifacts are used in qualitative research. The information is mostly non-numerical.

Researcher has Interviewed the founder of Restaurant Mr. Raja Sekhar Reddy. The interview is a valuable data collection technique that involves verbal communication between the researcher and the subject. Interviews are frequently used in survey designs as well as exploratory and descriptive research. Unstructured or in-depth individual Interview was conducted by the researcher. Researchers come up with the suitable findings and results regarding the different suitable factors of the study.

### **Findings and results based on Recruitment**

Recruitment is the foundation of any company's hiring process. Squaremeals Pvt Ltd wanted to provide SHI employment, so their first step was to visit Deaf and speech impairment schools. There are only seven such schools in Mumbai. Initially, they intended to interview only 25 people. The principal of the school was concerned because SHI people are socially mocked and have taken advantage of their situation, and he was not convinced. However, the founders later assured them with a proper business plan, and everything proceeded as planned.

On the day of the interview, those 25 candidates brought 4-5 family members with them so that they could answer questions on behalf of their wards. These family members also asked counter-questions because they were concerned about their safety at work. Making people believe and entrusting trust was thus a challenge for the employer. With 25 people on board, they began slowly and steadily with their first batch of employees. The next challenge was to train SHI employees.

### **Findings and Results based on Training**

Squarefoodmeals pvt ltd outsourced the training of 25 SHI employees as part of the CSR activity of the leading company in India. It was intended to last 90 days. Following training, they discovered that these SHI employees were perplexed and lacked confidence in dealing with customers at the restaurant. As a result, they intended to retrain them on the job. With this in mind, they altered their recruitment strategy. They hired another 25 capable individuals to act as a shadow while SHI employees received on-the-job training. At this time, the company has made it mandatory for abled employees to learn sign languages in order to better train and understand SHI employees. In addition, the company hired 1 Translator, 1 Functional Trainer, and 1 Behavioral Trainer. This made them realize that "Visual training" help SHI employees learn better.

As a result, the company's training continues to follow the same pattern, with 3-4 hours of classroom training to understand the terminologies.

Company have also developed their own manual on sign language to improve communication barrier at their workplace. Aabled Employees were also educated on the importance of reverse inclusion so that there is a culture of belonging and happiness.

### **Other Findings and Results**

Each restaurant employs a total of 50 people, with 25 being waiters, 25 being SHI employees, and the remaining 25 being abled employees (cooks, managers etc). Employee benefits are identical to those provided by any other employer. Through referrals within Mumbai, the company builds a pool of candidates. When it comes to terminating SHI employees, one must be extremely cautious so that they are not negatively impacted. In the process of terminating SHI employees, they must first notify their parents, and then make them understand the errors at work. SHI employees have more trust among parents than any other group.

### **CONCLUSION OF THE STUDY**

The concept of Reverse Inclusion has assisted organizations in being successful, where there is a balance of abled and SHI employees, which also brings about more sensitization in the workplace culture. Providing SHI individuals with employment opportunities demonstrates that disability does not imply a lack of ability to perform in a role. SHI employees can be a valuable asset to any company because of their unique perspective, loyalty, and skills. It may take some getting used to, and some kinks in the general workforce may need to be worked out, but the benefits are well worth the effort.

### **REFERENCES**

1. World Health Organization. Deafness and Hearing Loss. Available online: <https://www.who.int/en/newsroom/fact-sheets/detail/deafness-and-hearing-loss> (accessed on 25 November 2020).
2. <https://gupress.gallaudet.edu/annals/index.htm>

## Some Medicinal Plants Mix Grow with Mulberry Plant

Shashi Kanta

S.S.M. College, Dinanagar

### ABSTRACT

Sericulture industry is facing many challenges due to limited land resources, competition with other agricultural crops and climate. Kandi area of Punjab and adjoin area of Himachal also has its importance as these areas are herbs rich. Therefore, this area always catch by researchers to develop mutual harmony between sericulture and medicinal industries for of sustainable co- existence.

Local farmers want Mulberry is cultivated as tree under conditions in Kandi Area of Pathankot for their additional income, Punjab for sericulture. The gestation period of mulberry for sustaining silkworm rearing is 3-4 years. When plants are raised through cutting. Further, sericulturists do not earn much due to bivoltine rearing during spring and autumn, which keeps them busy only for three months and their 9 months, in this region remain free. The gestation period and afterwards remain periods of 9 months, every year. So wayb find for it is to adopt process of intercropping of medicinal plants to raise income of sericulturists of this region. This area is rich for medicinal plants. Present paper deals with the Survivability and prospects of intercropping of three medicinal plants viz. Aloe barbandense. Asparagus racemosu and Plumbago zeylanica.

Keywords: Mulberry, Medicinal Plants, Cultivation and medicinal plants.

### INTRODUCTION

Sericulture is facing tough time due to bivoltine crops, limited land resources and competition with other agricultural crops. Besides, the part of Kandi area of Punjab also has importanceas herbal rich area Therefore, there is an urgent need to have cropping between sericulture and medicinal industries for sustainable co-existence. The gestation period (4- 5yrs) between transplantation of the saplings and full tree capable of sustaining silkworm rearing and the lean periods after pruning of mulberry is July / December may effectively be utilized every year for the intercropping of medicinal plants to increase the income of sericulture Farmers and government. Due to heavy demands from pharmaceutical of industries, the over- exploitation of medicinal plants is leading to the destruction of habits and habitats and unsustainable harvesting practice has conservation and cultivation support of many valuable herbs. Since majority of sericultural farmers have very small land holdings and depend mainly upon family labor and simple tools, they neither have the capacity to take risk nor have enough land to diversify the cropping system. Thus, by growing other of short duration crops along with mulberry, the farmer gets additional benefits from intercrops .

In Punjab , intercropping of bush mulberry with lentil and Mung at (8'+2')x2' spacing have maximum returns from sericulture and cost of pulses thereby facilitating additional net gain from one acre of mulberry plantations during spring and autumn seasons. An additional incomecan easily be fetched by growing short duration crops like mustard and beans between rows of mulberry. Lot of work has already been done for integration of Sericulture with agriculture and horticulture . However, so far as intercropping of medicinal plants is concerned to increase the income of farmers and Government mulberry gardens, very little works has been done for integration of sericulture with medicinal industries. In hilly region of west Bengal, the net profit is increased by 26.3% from the Same piece of land without any additional investment When intercropping of turmeric and ginger, turmeric and field pea were practiced along with mulberry. Intercropping of mulberry with saffron in Kashmir yielded a good quality of mulberry leaf from the same field Where saffron was cultivated alone to generate work as well as good deal of returns to farmers during lean period when there are no operations related to saffron cultivation . Present communication deal with the initial studies conducted with respect to intercropping of seven medicinal plants in the mulberry gardens of directorate of sericulture, Dhar Block .

### MATERIALS AND METHODS

Intercropping of Medicinal plants was made under tree as well as bush cultivation system of mulberry. The mulberry plants maintained as tree under 10'x10' and 6'x6' spacing or as bush plantation under (8'+3')x2' spacing were utilized for intercropping of medicinal plants *Aloe barbadensis*, *Asparagus racemosus*, , *Plumbago zeylanica*. The propagation and nursery period during which these medicinal plants were raised is given in table.



**Table:** Survivability % of Medicinal plants under Intercropping with Mulberry

	Medicinalplants	Survivability % rate in free system(10''x10'')	Survivability % rate in free system(10''x10'')	Survivability % rate In free system(10''x10'')	Grand mean of Survivability %
1	Aloe Barbandensts	100	98.61	90.27	96.29
2.	Andrographis Paniculata	98.61	95.83	65.27	86.34
43	Plumbagozeylanica	98.61	91.66	88.88	93.05

The sapling of these medicinal plants were transplanted at their recommended spacings in Dharblock design in three replication during July-August in sericulture Research Centre of Dhar Block.. Each replication had 24 plants in all the treatments except in case of *Acorus calamus* and *Cyperus scariosus* which had 25 plants/replication in all the spacing. The living percentage of the medicinal plants was recorded and analysis was calculated following standard statistical procedures (Madhusudan *et al.*, 2013). The mulberry plants were Pollarded/ Pruned at 1.5 ft height from ground in bush system and at 5ft. height in tree system before transplantation of medicinal plants.

### RESULTS AND DISCUSSION

The live percentage of seven medicinal plants cultivated as intercrops in all the three plantation of mulberry raised (8'+3') x2' as bush and 6'x6' and 10'10' as tree has shown in table . Results reveal that maximum grand mean of Survivability was notice in 10'x10' spacing whereas maximum Survivability (100%) was found in Aloe barbandense and asparagus racemous and minimum Survivability was found in *Cyperus Scariosus*. 6'x6' Spacing of mulberry ranked Second Since Grand Mean of Survivallity was shown by *Rauvolfia Sertpentina* in 6'x6' Spacing of mulberry plants as Paired bush ranked third from the survivability points of view since it exhibited survivability . The cumulative overall survivalityb was shown by *Asparagus racemous* followed Aloe barbandense, , *Plumbago zeylanica*, which Shows that these medicinal Plants can successfully be grow as intercrops in mulberry gardens

When individual Survivability of medicinal plants is considered under all three spacings of mulberry bush/tree it was found that Aloe barbadense, has performed well. It is shown that these medicinal plants may be grown in all the three system. Results further revealed that *Andrographis paniculata* *Plumbago Zeylanica* serpentine Exhibited minimum survivability in 10'x10' tree system, hence these systems are not much suitable for intercropping of aforesaid four medicinal plants. Significant variation was observed between the survivability of cyperus with Aloe Barbandense, *Andrographis paniculata*, *Asparagus racemous* and *plumbago Zeylanica* at 10'x10' Spacing of mulberry tree, significant Variation in survivability of *Rauvolfia Serpentina* was observed with that of Aloe Barbadense, *Asparagus racemosus*. And *Cyperus scariosus* while *Andrographis paniculas* . *Andrographis paniculata* exhibited significant difference with the survivability of Aloe barbadense under paired row bush system.The medicinal importance and the availability of market in the revealed in this area. These seven medicinal plants very high and if Seri cultural farmers and Govt. Farms take up intercropping of these medicinal plants with mulberry their income will increase manifold .

### REFERENCES

1. Ahasn MM, Dhar KL, Fotadar RK and Dhar A (1989). Studies on the intercropping of short durations crops with mulberry. *Indian Journal of Sericulture* 28(2) 194- 199.
2. Arora S (2006). Preliminary assessment of soil and water conservation status in drought prone foot hill region of north-westIndia. *Journal of World Association of Soil Water Conservation* 5 55-63.
3. Fotadar RK and Dhar A (2012). Intercropping mulberry with aromatic plants in Jammu and Kashmir. *Indian Silk* 3(7) 14-16.
4. Gargi Sukla P, Kumar D, Kumar R and Pandey RK (1997). Intercropping for profitable in purvanchal. *Indian Silk* 35(11) 31-32.
5. Gupta RD, Arora S, Gupta GD and Sumberia NM (2010). Soil physical variability in relation to soil erodibility under different land uses in foothills of siwaliks in N-W India. *Tropical Ecology* 51(2) 183-187.
6. Kaur R, Mir MR, Khan MA and Mir S (2002). Intercropping of mulberry with saffron. *Indian Silk* 41(2) 5-6.

7. Koul A, Gupta A, Singh D and Gupta SP (1996). Intercropping of vegetables in mulberry. *Journal of Sericulture* 4(20) 48-51.
8. Chamoli VK, Varshney PK, Srinivasan Rajeev Pandey and Rameshwar Dayal (2013). Assessment of Biomass Yield ,Essential Oil and Beta Asarone content of *Acorus Calamus* L. intercropped With *Morus alba* L. *Journal of Essential oil Bearing Plants* 16(6) 763-770.
9. Pandey RK and Dhar Anil Mulberry (2013). Intercropping for Sustainable Livelihood in Kandi Area of RuralSub-Himalayan, India. Regional Sericultural Research Station, CSB Complex, Miransahib - 181 101, Jammu (Jammu & Kashmir), India. *Research Journal of Agriculture Sciences* 4(4) 484-487.
10. Rathore MS, Srinivasulu V, Kour R, DharAnil and Sahaf KA (2012). Biochemical Analysis of Mulberry Associated with intercropping Medicinal Plants under Temperate Condition. *Journal of Pharmaceutical & Scientific Innovation* 1 (4) 45.

## Effect of Irrigation Systems on Growth of Various Parts of Mulberry Plant by Spacing Method

Shashi Kanta

S.S.M.College, Dinanagar

### ABSTRACT

Mulberry is a hardy plant control by agro climatic conditions. it is also sensitive responding extremely well to optimum agricultural inputs but showing practically no growth when plant nutrients and moisture begin to operate as limiting factors. This is evidence from the fact that under the poor rainfall conditions prevailing in India, the current leaf yield is of the order of only 3,000-3,500 kgs per hectare whereas under assured irrigation and appropriate fertilizer application, it can be stepped up to 30,000 kgs.

After monsoon water is the limiting factor and adversely affects the growth and leaf of mulberry and consequently the raw silk production particularly during the dry period, December to May Spacing recorded 15.58% increase over wider spacing possibly due to increase plant population. As such; it is suggested to use micro-sprinkler system. A field experiment was carried out during December to May for two years at the Central Sericultural Research & Training Institute, Sujapur for two years. S type cultivation of mulberry with two different spacing methods viz. 60x60cm and 45x15 cm in a split-plot design having three replications. Four systems of irrigation viz. drip, micro-sprinkler, subsurface and alternate furrow were used each with two levels of irrigation based on I W/CPE (irrigation water/cumulative pan evaporation) ratios of 0.4 and 0.6 the plants were maintained following the recommended package of practices for irrigated mulberry. The result was 3,500 kg per hectare whereas under assured irrigation and appropriate fertilizer application, it can be stepped up to 30,000 kg or so, or nearly ten times.

Monsoon water becomes the limiting factor and adversely affects the growth and leaf of mulberry and consequently the raw silk production particularly during the dry to 5.0 ha cm of water in mulberry garden by furrow method at 10 days intervals for sandy loam soil and at 15 days intervals for clayey loam soil during December to April in south India while in Punjab indicated that plants height, number of branches and level per plant and leaf yield due to irrigation at 0.4 and 0.6 IW/CPE ratios being at per the lower level of irrigation is preferable thereby saving 33% of irrigation water vis-à-vis the earlier recommendation of 4.5 ha cm at fortnightly intervals. As regards the system of irrigation, micro-sprinkler irrigation recorded significantly taller plants, higher number of branches and leaves (plant and leaf yield) over drip, subsurface and alternate furrow systems of irrigation, the first three systems recording 23.45%, 11.34% gain over alternate furrow method, the drip and subsurface system being at par. Wider plant spacing (60 x 60 cm) recorded significantly taller plants (114.95 cm), higher number of branches (9.37) and leaves (189.48)/plants vis-à-vis closer spacing (45x15 cm). on the other hand leaf yield due to close irrigation at 0.4 IW/CPE ratio

Keywords: Micro-sprinkler, drip, subsurface, alternate furrow irrigation, IW/CPE ratio, mulberry, spacing, growth, leaf yield.

### INTRODUCTION

Mulberry is a hardy plant capable of thriving under a variety of agro climatic conditions. At the same time, it is also sensitive responding extremely well to optimum agricultural inputs but showing practically no growth when plant nutrients and moisture begin to operate as limiting factors. This is evident from the fact that under the poor rainfall conditions of 25-30 (625-750 mm) prevailing in South India, the current leaf yield is of the order of only 3,000- period, December to May. Thus to overcome this limitation and to augment the yield irrigation is essential for mulberry. It is reported that irrigation given between December and April significantly increased the leaf yield by 68% (Kasiviswanathan and lyenger, 1965). It was advocated to apply 3.

### MATERIALS AND METHODS

In December to May for two year experiment was done in the field at the central Sericultural Research & Training Institute. Sujapur, using S, cultivar of mulberry with two applications of 4.5 ha cm of water for clayey loam soil at fortnightly intervals between December and May was suggested through the conventional flood irrigation. In another experiment at Dinanagar for mulberry sapling with 60 cm x 60 cm spacing of Punjab. considered drip and sprinkler irrigation systems to be more efficient in economizing water use and maximizing the leaf yield of mulberry. However, in the past, water requirement of mulberry through micro-irrigation systems was worked out based on conventional approaches. As such information on scheduling of irrigation

based on climate only which is now considered more scientific and efficient method of irrigation. Different micro irrigation system under different plant spacing is lacking. Thus, to make a comparative study on the efficacy of different micro irrigation system and alternate furrow system at different IW/CPE ratios and plant spacing, this experiment was undertaken.

1. To conduct research and developmental work for improvement in quality mulberry leaf productivity by evolving appropriate irrigated and rain fed agronomical packages for high yielding mulberry varieties from time to time.
2. To develop cost-effective mulberry cultivation technology.
3. Eco -friendly technologies, maintenance the soil health and redress of agro-ecological condition with curtailment of inorganic fertilizers in mulberry cultivation.

## RESULTS AND DISCUSSION

### Effects of level of irrigation (IW/CPE ratio):

Irrigation at 0.4 and 0.6 IW /CPE ratios with 3.0cm and 4.5 cm depth of irrigation water (i.e. 3, 00,000 I water /ha and 4, 50,000 I water /ha) did not influence the plants height, number of branches and leaves per plant as also the leaf yield the growth and yield parameters due to irrigation at 0.4 and 0.6 IW/CPE ratios being at per the lower level of irrigation is preferable. Different spacing i.e. 60x60 cm<sup>2</sup> and 45x15 cm<sup>2</sup> It was laid out in a split –plot design having three replications .The treatment comprised four system of irrigation –viz. Drip micro sprinkler, subsurface and alternate furrow each with two levels of irrigation based on IW/CPE ratio mentioned above in the sub –plots. Drip system consisted of fixed CPE value of mm in main plots and two different spacing as mentioned above in the sub plots. Drip system consisted of emitters at 60 cm intervals for 60x60 cm spacing and at 30cm intervals for 45x5 cm spacing with the laterals laid between alternate rows The sprinkler system was a non – portable micro – sprinkler type sub- surface irrigation system consist of bi-wall perforated tubes laid in alternate rows. The sprinkler systems was a non-portable micro- sprinkler type (four per plot).sub – surface irrigation system consisted of bi-wall perforated tubes laid in alternative rows at 20 cm depth of soil and having pores at 30 cm intervals .the plot size was 4.88x4.88m. Mulberry plants of all the plots were given bottom pruning during last week of November and February every year and were maintained uniformly following the recommended “package of practices” In case of micro-irrigation system was given at four days intervals during winter and at three days intervals during summer spread over a fixed CPE value of 75 mm while in alternate of water at 1.0kg pressure per unit time through the micro-tube of drip, micro-sprinkler and pore of the sub –surface systems while alternate rainfall received between two irrigation ,if any ,was considered for calculating the subsequent date of irrigation. Plant height, number of branches, leaves per plant and leaf yield were recorded during February and May over the two years AS the trends of results were found to be almost similar

Spacing significantly influenced the height of plants, number of branches and leaves per plants as also the leaf yield; wider spacing (60x60 cm) recording significantly taller plants, number of branches and leaves (189.48) per plant compared to closer spacing (45x15cm). However, as regards leaf yield, closer spacing registered significantly higher yield.

### Effect of various irrigation systems:

1. Micro-sprinkler system of irrigation recorded sufficiently taller plants (116.72 cm) compared to drip, sub-surface and alternate furrow systems, the latter three being at par.
2. Numbers of branches per plant was also found to be significantly higher in micro-sprinkler irrigation than in case of drip, sub-surface and alternate furrow systems. The last two systems as well as the drip and sub-surface were at par but the drip showed significantly higher number of branches compared to alternate furrow system.
3. Number of leaves per plants was found to be significantly higher in case of micro –sprinkler irrigation than in drip, sub –surface and alternate furrow systems, the last three being at par.
4. Micro- sprinkler irrigation is better than drip, sub –surface and alternate furrow system, the last three being at par.
5. Micro-sprinkler irrigation registered significantly higher yield (13123.35 kg/ha) over drip (11836.42hg/ha), sub –surface (11825.89kg/ha) and alternate furrow (10630.58kg/ha) systems, were at par yet showing 23.45%,11.34%and 11.24%gain over alternate furrow irrigation.

6. Drip and sub-surface systems were at par yet showing significantly higher yield over alternate furrow system

#### REFERENCES

1. Choudhury PC and Giridhar K (1987). Mulberry cultivation. In: Appropriate Sericulture Techniques, Edited by M.S Jolly. Mysore India 17-34.
2. Kasiviswanthan K and Iyenger MNS. Preliminary observation on varietal- cum-irrigational response to different levels of N on the seasonal and total yield of mulberry leaf. Indian Journal of Sericulture 4(4) 22-23.
3. Krishnaswami S (1986). Mulberry cultivation in South India. Central Silk Board, Bangalore, pp. 1-19. Mukherjee, SK, Ray D and Pain AK (1972) Influence of irrigation on the yield of bush mulberry raised under Bengal and Mysore systems of Plantation. Indian Journal of Sericulture 33-36.
4. Purohit KM, Ghosh JK, Sen, Das and Saratchandra N (2006). B. Comparative Studies on the Efficacy of Microsprinkler, Drip, Subsurface and alternate Furrow Irrigation Systems on Growth and Leaf Yield of Mulberry In: The Gangetic Planes Of West Bengal, Proceeding of Regional Seminar Prospects and Problems of Sericulture as an Economic Enterprise in North West India.pp.60-63.
5. Purohit KM, Ghosh JK, Sen, Das and Saratchandra N and Sarkar A (2005). Effects of different/levels and methods of irrigation on growth and leaf yield of mulberry during dry period in the Gangetic plains of West Bengal. 20<sup>th</sup> Congress of International Sericultural Commission, Dec .15-18, Bangalore, Conference Papers.
6. Rao, Prabhakar A, Mallikarujanappa RS Dandin SB (2000). Studies on effect of different plant spacing on leaf yield and quality of Ms Mulberry Genotype under Semiarid Conditions of Karnataka, Karnataka Journal of Agriculture Sciences 13 (4) 882-886.
7. Saratchandra B, RaJanna L, Para, esha, C, Jayappa, T Sabitha, MG, Philomena KL and Remesh SP (1992). Studies On the comparative efficiency of drip sprinkler and furrow irrigation systems on mulberry leaf yield and water economy. Sericologia, 32 (1) 95-100 -36.
8. Sikdar AK and Chandrashekar DS (1992). Drip irrigation system for mulberry Indian Silk vol.31(5): 45-8. Yoganada Murthy VN, Ramesh HL, Munirajappa, Rajkumar (2013). Evaluation of Mulberry (Morus) Variety Vishwa for Leaf Yielding Parameters and Phytochemical Analysis under Different Spacing Systems. The global journals 3(8) 31-33.

## Impact on Development Sericulture Activities to Enhance Silk in Punjab

Shashi Kanta

S.S.M.College, Dinanagar

### ABSTRACT

Sericulture is one of the most important cottage industries in India. But still not sufficient research has been conducted in India for development and evaluation of sericulture activities. Sericulture is a short gestated and labor intensive cottage industry which can be helpful to remove poverty in the rural areas. Times to time new Sericulture activities are developing. Punjab initiated to strengthen the already existing setup and to promote the sericulture activities in the rural areas. This project envisaged distribution of silk seed packets at subsidized cost, give training to jobless and marginalized income rural people to engage them in the silkworm rearing practices as earning source. Mulberry nurseries were also raised at the project area locations on the state lands to provide mulberry leaves to the silk rearing for farmers at a nominal cost. A well structured Questionnaire was designed to collect data randomly from some selected households where people doing this silkworm rearing. Data was collected as survey plan. The data analyzed by using Statistical Package of Social Sciences and conclusion and recommendations were drawn. The relationship among these variables was studied using appropriate statistical techniques. The paper is related to results of these Questionnaires and also give recommendation for enhance sericulture production.

Keywords: Socio-economic development, Sericulture, Punjab, Impact Evaluation, and questionnaire.

### INTRODUCTION

Sericulture is one of the most important cottage industries in India. But still not sufficient research has been conducted in India for development and evaluation of sericulture activities. Even there are not full fledged sericulture research center established in all states of India for the production of better quality of silk and maximum silk product. Silk seed produce diseases free cocoon to generate high volume and high quality of silk.

This paper is focus to enhance the production of best quality cocoons and a high yielding cocoon crop. This study would be useful for future breeding programs and commercial rising of sericulture activities in Punjab. For this purpose a development project was initiated by Sericulture department of Punjab. Punjab Govt. took many initiative to strength the activities of sericulture and its culture activities in the Punjab to improve the socio-economic conditions of rural people and increase production of silk at national level. In Punjab, sericulture industry has limited growth mainly due to poor quality of mulberry leaves and silk seed. Sericulture industries depend upon Mulberry leaves because it is main food of silkworm in Punjab. Thus the cultivation of mulberry is one of the most important factor in the production of silkworm eggs, rearing of silkworm cocoons. The main idea of this paper is to increase the production of best cocoons in quality and quantity for a high yielding cocoon crop and formation of high quality cocoon crop. Availability of silkworms cocoon and mulberries is related to climate and ecological conditions such as rainfall, temperature, relative Humidity, soil quality, etc. He worked for the evaluation of genetic potential of inbred pure lines of silkworm for breeding and cocoon production. The large genetic variability concerning mulberries as well as silkworms opens up many possibilities for breeding and selection. Punjab has, in some area very favorable climate for rearing of Sericulture. One experiment done by the dept. of sericulture, as per their

report, they concluded that the project increased the income of bivoltine sericulture and mori culture activities e.g. Herbal medicine, fodder for cattle, for soil preservation. Sericulture development provides opportunities to improve the living standards of people in the rural area in developing countries. In Punjab, sericulture industry also work on this pattern to increase growth due to poor quality of mulberry leaves and silk seed. Sericulture industries depend upon Mulberry leaves because it is main food of silkworm in Punjab. Thus the cultivation of mulberry is one of the most important factor in the production of silkworm eggs, rearing of silkworm cocoons. The main idea of this paper is to increase the production of best cocoons in quality and quantity for a high yielding cocoon crop and formation of high quality cocoon crop. On this way enhance upgrade social economic status of people of Punjab. The information yield in this study would be useful for design future breeding programs and commercial rising of sericulture activities in Punjab. Further the data analyzed by using the evaluation index method each breed was maintained in three replications. Despite of these efforts success was not attained in sericulture and mori culture activities in Punjab. For this purpose a development project was initiated by Sericulture department, to strength the activities of sericulture in the province to change the socio-economic conditions of rural area people. It was also tried to know through

instrument (questionnaire) how much sericulture has developed in Punjab after this intervention and why previous efforts in this regards were not fruitful? Evaluation team was also supposed to know about the pros and cons of sericulture activities in Punjab due to which this idea has not been successful in Punjab; however, it is fairly working in other countries of similar topography, culture and climate.

### **MATERIALS AND METHODS**

Keeping in view the importance of the project's impact, the questionnaire has given to selected families for survey for following points. To measure the impact of the project activities Total sample of 1000 questionnaire were filled from the people from selected district Pathankot and displays the distribution of data collection through questionnaire in selected districts. Which is proportionally based on the number of beneficiaries in each district shown in table?

**Table: Indicators of Impact Assessment**

Impact Indicators	Description
1. Age & Gender	%age of Male or Female, age of person
2. Education	Education level
3. Motivation for silk rearing	reason is to in involved in silk
Rearing activities	
4. Experience of silk rearing	how many years are involved in silk rearing?
5. Level of Income	families' income
6. Availability of Silk Seed	Satisfaction of beneficiaries in availability to silk seeds
7. Quality of Silk seed	Satisfaction of beneficiaries on the quality of silk seeds
8. Availability of food (Mulberry Leaves)	Satisfaction of beneficiaries in availability of food (Mulberry Leaves)
9. Training & Quality of Training rearing	No. of and quality of the trainings provided to the farmers for silk rearing
10. Production & Quality of Production	Production (quality and quantity) of cocoons by villagers
11. Income Generated through Sericulture	Level of income generation through sericulture activities.
12. Use of Income Generated Through	According to need on which income utilize.

This statistical study was carried out to collect data from the sericulture farmers involved in silkworm rearing district of Punjab Pathankot. This Random Questionnaire Sampling was used to the selected households in Pathankot district of the Punjab. Total sample of 1000 Questionnaire were filled from the selected districts. The distribution of data collection through questionnaire is based on the number of beneficiaries in district.

### **RESULTS AND DISCUSSION**

#### **Data verify:**

The analysis has been made based on the data obtained from beneficiaries on questionnaires filled from Pathankot districts of Punjab.

Based on the analysis, it was observed that more than 50 % sericulture farmers were women. Silk rearing activities are usually done by females for additional source and male do their jobs main earing of families. Ages of respondent were ranging from 14 to 80 years. 86 percent families that were involved in silk rearing for income generation to uplift their living. However, 14 percent had various other motivation factors such as learning and skill development, loan payments were the main factors to motivate them for silk rearing. 58 percent of the respondents were involved in silk rearing for more than five years.

Income from silkworm rearing by farmer was ranging from 6,000 to 10,000 per month. 44.6 percent of the target respondents were having income less than or equal to Rs. 6,000 per month. 30.7 percent of the respondents were having monthly income equivalent to Rs. 8,000 whereas, 24.7 percent respondents were those having monthly income Rs. 10,000 or above.

Based on the analysis, 97 percent of the farmers got the silk seeds from the Sericulture Department and 3 percent were those which were never involved in sericulture activity. Responding to the question of per kg sale of cocoon, minimum sale price of cocoon was found in survey was Rs. 160 and maximum selling price was Rs. 350.

95% were of the view that sericulture activities have a significant impact on family income, these families utilize the income generated through these activities on clearing loans, purchase of assets, education of their children, sustaining livings, marriages of their children and buying cattle's etc as shown in table 5

**Table 5**

**Earning from Sericulture:**

**Investment (for 30 days)**

Cost of Silk Seed Packet = Rs. 250

♣ Cost of forty days labor (2 hours per day) = 50\*

Total Investment 2.40 = Rs. 4,000

♣ Mulberry leaves (food for worms)

= Rs. 300

Mulberry leaves (food for worms)

Total Investment = Rs 4,650

**RETURN AFTER 30 DAYS:**

Total Investment = Rs 4,650

Production \* average selling price) = Rs. 6,380

Based on above analysis, return of sericulture activities is about 37% higher than its investment.

This inferential analysis was developed on the basis of prior knowledge .association of factors involved in sericulture activities e.g. education of farmers, income of the households/farmers, training of farmers from Sericulture Department and production level of Cocoon.

The null hypotheses (Ho) using  $p \leq 0.10$  was determined as under:

- There exists a positive association between education of the farmer and production level of Cocoon;
- There exist a positive association between the education and income of the farmer; and
- There exist a positive association between training of the farmer from Sericulture Department and production level of Cocoon. The alternate hypothesis H1 was assumed that there does not exist any association between these factors. The parameters were tested using a well known non-parametric chi-square test statistics.

**REFERENCE**

1. Kusnaman, D., (2004): Development Planning and Project Cycle analysis for Sericulture in Central Java, PhD thesis.Landwirtschaftlich-GärtnerischenFakultät, 45-56, (2004).
2. Hussain, M., Khan, S.A. and Aslam, M., (2010): Evaluation of genetic potential of inbred pure lines of silkworm for breeding and cocoon production in Pakistan, African Journal of Food Science, 4(5),300–302 .
3. Singh K.K, Pande A.B and Tiwari D.K (2006): Study on Prospects of promoting of multiple Silkworm Rearing Crops in Mandi District of Himachal Pradesh. Proceedings of Seminar Prospects and Problems of sericulture as an Economic Enterprise in North West India 257-263.
4. Hamaoka, M.,(2012) Evaluation Report of Project for Strengthening Extension System for Bivoltine Sericulture in India, Project Foundation for Advanced Studies on International Development available on [http://www0032.jica.go.jp/en/evaluation/pdf/2009\\_0602342\\_4.pdf](http://www0032.jica.go.jp/en/evaluation/pdf/2009_0602342_4.pdf). 5 5.Mark, M.M and Henry, G.T., (2004): The Mechanisms and Outcomes of Evaluation Influence: SAGE Publications, London, Thousand Oaks and New Delhi), 10 (1), 35-57, (2004).



6. Mishra PN, Srivastava PK and Chakrabarti S (2006). Prospects and problems of sericulture as an economic enterprise in North West India, Nov.11-12, Regional Sericultural Research Station, Central Silk Board, Dehradun, India 41-57.
7. Chaudhry, S. M. and Kamal, S.(1996), Introduction to Statistical Theory(Part-II, 6th Ed.) Ilmi Kutab Kahana, Lahore, 99-101.
8. A Case Study of Projects “Development of Sericulture Activities in Punjab” Pakistan Journal of Science Vol. 65 No. 2 , 263-268.

## **A Study of Employee Training Practices of Reputed Hotels in Capital Complex of Arunachal Pradesh**

**Karjum Riba<sup>1</sup> Rosna Magra<sup>2</sup> and R.C. Parida<sup>3</sup>**

<sup>1,3</sup>Commerce, Rajiv Gandhi University, Doimukh-791112

<sup>2</sup>Management, Mizoram University, Aizawl-796004

### **ABSTRACT**

Training is needed by every organisation to ensure that the employees are performing their work properly. The continuously changing business environment has increased the importance of training as jobs are becoming more complex and new techniques are developed day by day for doing different jobs which are pertaining to more productive and qualitative. The hospitality industry as a whole has seen a lot of growth in the past decade. The growth and expansion of the Hotel industry are leading to an increase in competition in the industry. In this scenario of growth and competition organisations rely on training function which bridges the gap between skills present and skills required by the human resource working in the organisation. This study mainly focuses on the training practises followed by Reputed hotels of capital complex Arunachal Pradesh. For the purpose of the study 14 reputed hotels and 188 employees were surveyed. The results of the study show positive changes in employee after training programme. The problems regarding training were also studied and given appropriate solutions.

Key words: Reputed hotels, Training need, Training outcome, Training Practices, Training problems.

### **1. INTRODUCTION**

Training is the learning process by which an effort is made to increase the knowledge and skills of an employee for the successful accomplishment of business tasks. Also, training is an organisational process by which people learn knowledge and skills for specific purposes (Beach, 1980). It is a sequence of experiences that are designed to modify the behaviour of trainees in order to attain objectives (Hesseling, 1971). The objectives of the training are to improve the work methods and skills of employees, to prevent obsolescence, to prepare employees for higher responsibilities, etc. And organisations can analyse the needs and requirements of their employees and apply different methods to train them. The organisation can use methods like lecture, coaching etc for the training of their employees. Three distinct phases of training are Pre-training, Training, and Post-training (Lynton & Pareek, 1990). Training is the process that helps trainees to meet the objectives and goals of organisation (Chowdhry,1994). Nowadays, the continuously changing business environment has increased the importance of training. Training is a continuous process and employees' skills should be updated regularly to keep up with the present competitive environment. Training is very much required by all the organisations not only for improving employee's performance and productivity but also for the overall growth of the organisation in every sector of the economy.

Many international hotels chains have also come to India over the last few decades. The state of Arunachal Pradesh has also seen a growth in the hospitality industry with several new hotels and resorts etc have opened for business in the state. The state's Capital complex has also seen an increase in the number of hotels over recent years.

In the Hotel industry training of the employees is very much needed. Since it is extremely competitive and providing great service to the customers is very much required to stay ahead in the competition. Training helps staff in giving better services to the customers so that customers satisfaction can be augmented. The lack of skilled and trained personnel is also one of the challenges faced by the hotel industry. Therefore, training becomes an important function to upgrade the skills of the hired workers/employees. The present study is undertaken to find the training practices of Reputed hotels in the capital complex of Arunachal Pradesh.

### **2. LITERATURE REVIEW**

Reviews of several pieces of literature relating to different aspects of training and training in the hotel industry have been carried out. There has been many debates and difference in opinion of the researcher around the globe regarding training practice. But most researchers agree on the importance of training in organisations. Similarly, the literature reviewed are also consistent in this regard for the hotel industry, that training is important in the hotel industry. In their research Malonza & Walaba (2015), have found that employees who have been trained showed improvement in their performances. Which was also supported by study of Nda & Fard (2013), according to them training changes employee behaviour and enhances their skills which result in

enhancing the performance of the employee. Hazra, Ghosh & Sengupta (2017) further add that training helps employees in developing a new skill, refresh the knowledge of old employees, improves safety, health of employees and also helps employees in developing their future career prospects.

Many researchers also have emphasised the training need assessment for the success of the training programme. Ludwikowska, (2018), stated that training needs analysis to increase employee efficiency. Sharma, (2018), has found that the failure of the organisation to train employees according to their training needs hinders the performance of the employees.

Different studies have been conducted on the effectiveness of training method, Mahadevan & Yap (2019) stated that both on-the-job and off-the-job method has a positive impact on employee performance with the on-the-job method having slightly more impact on employee performance. The coaching method has been stated to be effective in training method in increasing employee performance by Abdiwali & Musa (2019), they also have stressed induction training for the new employees.

### 3. OBJECTIVE OF THE STUDY

- To find out if training needs of employees are considered before training in reputed Hotels of Capital complex.
- To find outcomes of training employees in reputed Hotels of Capital complex.
- To find problems relating to training and offer suggestions.

### 4. RESEARCH DESIGN

#### 4.1 POPULATION AND SAMPLING

Total of 14 Reputed hotels were taken for the study. The Cochran Formula for finite population was used for calculating employee sample and gave the sample size of 187.62 which was rounded up to 188 employees. The convenient sampling technique is used for the collection of data from employees and hotels. The data were collected from October 2019 to June 2021.

#### 4.2 TOOLS FOR DATA COLLECTION

The questionnaire is used for the purpose of collecting data for the study. Likert scale was used to make the questionnaire. The questionnaire consisted of 16 questions and was divided into two parts first part consisting of questions relating to demographic profile of the respondents and the second relating to training practices carried out in their hotels.

#### 4.3 METHODS FOR DATA ANALYSIS

The data were analysed by tabulating the responses of the respondents based on questionnaire. Frequency, percentages and mean were used for the analysis and interpretation of the data. Cronbach's alpha has been used for questionnaire of employees. The questionnaire has value of 0.862 alpha and so is confirmed as highly reliable and are valid for analysis purposes. The hypotheses are tested using the Chi-square test. Various statistical tools like MS excel, Ms word were used during the study.

#### 4.4 AREA OF THE STUDY

For the proposed study Capital complex (comprising Itanagar and Naharlagun towns), Papumpare district of the state Arunachal Pradesh is selected as the focal area of study. The town of Itanagar and Naharlagun is called the "twin capital city". The capital complex covers an area of 200 sq km and a population of above 1 lakh people.

#### 4.5 DATA ANALYSIS

Table 1: Demographic profile of the employees

Demographic Features		Frequency	Percentage	Cumulative percentage
Age	Below 20 Years	8	4.3	4.3
	20-30 Years	124	66	70.2
	31-40 Years	45	23	94.1
	41-50 years	11	5.9	100
Gender	Male	164	87.2	87.2
	Female	24	12.8	100
Qualification	Higher education	139	73.9	73.9
	Graduate	29	15.4	89.4
	Post- Graduate	6	3.2	92.6

	<b>Others</b>	<b>14</b>	<b>7.4</b>	<b>100</b>
<b>Employee Experience</b>	<b>Less than 1 year</b>	<b>35</b>	<b>18.6</b>	<b>18.6</b>
	<b>1-5 years</b>	<b>90</b>	<b>47.9</b>	<b>66.5</b>
	<b>6-10 years</b>	<b>30</b>	<b>16.0</b>	<b>82.4</b>
	<b>Above 10</b>	<b>33</b>	<b>17.6</b>	<b>100</b>

Source: Field survey

**Table 1** shows the demographic profile of the employees working in the hotels. 70% of the employees are below 31 years. 87% of the employees working in hotels were male and less than 20% were female. Less than 20% had graduate and post graduate degree, 73.9% have higher education and 7.4% has other basis education.

**Table 2: IS Training Provided to employees?**

Training Provide	Frequency	Percentage	Cumulative percentage
<b>Yes</b>	<b>140</b>	<b>74.46</b>	<b>72.3</b>
<b>No</b>	<b>48</b>	<b>25.54</b>	<b>100</b>

**Table 2**, shows that 74.46% of the employee are given training by the reputed hotels and 25.54 are not given training.

**Table 3: Employee Training needs in Reputed hotels**

Statements	N	Minimum	Maximum	Mean	SD
Employee's skills and knowledge are assessed before training	140	2	5	4.01	.569
Training given are relevant to employees' work	140	1	5	4.04	.698
Employees are provided sufficient information about training goals	140	3	5	4.04	.542
Employees participate in determining their own training needs	140	2	5	3.92	.537
Employees undergoing training programmes understand the objective of training programs	140	2	5	4.03	.634
At the end of the training feedback are taken from the employees	140	2	5	4.16	.660
<b>Overall mean</b>	<b>140</b>			<b>4.03</b>	

Source: Field survey

**From Table 3**, it can be seen that the overall mean value is 4.03 which indicates that the employee of the Reputed hotels agrees that their training needs are taken into consideration before training is provided to them.

**Table 4: Employee Training Outcome in Reputed Hotels**

Statements	N	Minimum	Maximum	Mean	SD
After training employees are able to perform jobs and task better	140	3	5	4.17	.599
Training improves the performance of the employees	140	3	5	4.16	.591
There is improvement in skill and knowledge of employees after training	140	3	5	4.13	.663
Employee gain self confidence in performing jobs after training	140	2	5	4.12	.593
Employee manage their time better after receiving training	140	1	5	4.04	.616
Employees acquire valuable professional experience during training	140	1	5	3.95	.743
Training has increased the quality of work of the employees	140	1	5	4.09	.581
Employee productivity increases after undergoing training	140	1	5	4.05	.554
<b>Overall mean</b>	<b>140</b>			<b>4.08</b>	

Source: Field survey

**Table 4**, shows that overall mean value of training outcomes is 4.08 which means that training gives an overall positive outcome and helps the employees in improving their skills and performance.

**Table 5: Problems related to training**

Statements	N	Minimum	Maximum	Mean
Absence of proper equipment and material while training	140	2	5	3.53
Absence of proper Training structure	140	1	5	2.63
Mismatch between theoretical and actual practise	140	3	5	3.41
Language and communication	140	2	5	2.28
Absence of proper Training instructor/ trainer	140	2	5	2.06
Accommodation and transportation problem	140	2	5	2.16

Source: Field survey

**Table 5**, shows that Absence of proper equipment and material while training and Mismatch between theoretical and actual practise are the problems related with training.

## 5. RESULTS AND DISCUSSION

The results of the study shows that majority of the employees working in reputed hotels of capital complex of Arunachal Pradesh are provided with training i.e., more than 70%. The hotels are dominated by male employee which make up to more than 80% of workforce and less than 20% are female employee. The training programmes are conducted taking consideration of the training need of the employees like their skilled are assessed, training is relevant to their work, employees are participating in determining their needs. Training results in improvement of performance of the employees, productivity increases, quality of work increases, they are able to perform jobs and task better, confidence in performing jobs increases, they acquire valuable professional experience and manage their time better. Absence of proper equipment and material while training and Mismatch between theoretical and actual practise are the problems were identified as problems relating to training in the reputed hotels. Chi-square (goodness of fit) was conducted in whether there is an association between employee experience and training needs of the employees and employee experience and employee training outcome the results of the test gave value of .057 and 0.689 which are greater than p-value of 0.05 so the null hypothesis was accepted and alternative hypothesis was rejected. Hence, no significant association was found between the experience of employee working in the hotels with their training needs and also their training outcome.

## 6. SUGGESTIONS

- Proper equipment and materials should be provided by the Reputed hotels for training programs so that employees are trained more properly and understand the training process better. Proper list of equipment and materials should be prepared while planning the training programmes, so that these are procured and ready before the start of training programme.
- The trainers should make sure that there is no difference between the theories taught to the employees with the actual practice of the work. So those employees are not confused with what they are taught and the practical application of it. Theories and application of it should be taught to the employee side by side.
- The proper structure should be set up for training the employees in Reputed Hotels. The employee should know the procedure to be followed while in training and should know the details about each step of training programs so that there is active participation by the employees.

## 7. CONCLUSION

The study is based mostly on primary data and covered 14 Reputed Hotels in the capital complex (Itanagar and Naharlagun) of Arunachal Pradesh. A total of 14 HR managers and 188 employees were surveyed for the purpose of the study.

The finding of the study shows that training need of employees is taken into consideration before providing training to the employee. The training outcome shows that after training there is improvement in employee's work and task, knowledge, and skills, confidence in performing jobs, quality of work, productivity, etc. which are also in line with previous studies. The problems with training were also identified and suggestions were extended accordingly.

Training is important for all industries and also the Hotel industry as the employees in the hotels have to directly deal with customers, they should be trained properly to give their best to satisfy the expectation of the customer which will ultimately help in the growth and also contributes to the reputation of the Hotels.

#### REFERENCE

1. Abdiwali, R., & Musa, M. (2019). On-The-Job Training and Employee Performance in Petroleum Companies in Uganda. *International Journal of Research- Granthaalayah*, 7(8), 51-61.
2. <https://doi.org/10.29121/granthaalayah.v7.i8.2019.638>
3. Beach, D.S. (1980). *Personnel: The Management of people at work*. New York: Macmillian.
4. Choudary, D.P. (1994). *Handbook of training methodology and management*. New Delhi: Inter-India Publication.
5. Hazra, K., Ghosh, P., & Sengupta, P. P. (2017). Importance of Training and Development and its Impact on Employees' of Hotels in Kolkata, India: An empirical study. *Journal of Tourism and Hospitality Management*, 5(2), 23-33.
6. <https://doi.org/10.15640/jthm.v5n2a3>
7. Hotel. (n.d.). *Merriam webster.com dictionary*. Retrieved from <https://www.merriam-webster.com/dictionary/hotel>
8. Kum, F. D., Cowden, R., & Karodia, A. M. (2014). The impact of training and development on employee performance: A case study of ESCON Consulting. *Singaporean Journal of Business Economics and Management Studies*, 3(3), 72-105.
9. <https://doi.org/10.12816/0010945>
10. Lubke, Gitta H.; Muthen, Bengt O. (2004). Applying Models for continuous outcomes to Likert Scale data complicates meaningful group comparisons. *Structural Equation Modeling*, 11, 514-534.
11. [https://doi.org/10.1207/s15328007sem1104\\_2](https://doi.org/10.1207/s15328007sem1104_2)
12. Ludwikowska, K. (2018). The effectiveness of training needs analysis and its relation to employee efficiency. *Zeszyty Naukowe Politechniki Poznańskiej. Organizacja i Zarządzanie*, 179-193.
13. <https://doi.org/10.21008/j.0239-9415.2018.077.11>
14. Lynton, R.P., & Pareek, U. (1990). *Training for Development*. New Delhi: Sage publications.
15. Mahadevan, A., & Yap, M. H. (2019). Impact of Training Methods on Employee Performance in a Direct Selling Organization, Malaysia. *IOSR Journal of Business and Management*, 21(10), 7-14.
16. <https://doi.org/10.9790/487X-2110010714>
17. Malonza, R., & Walaba, P. (2015). Effectiveness of Staff Training on the Performance of Hotels in Kisumu City, Kisumu County, Kenya. *International Journal of Science and Research (IJSR)*, 5, 2129-2133.
18. <https://doi.org/10.21275/ART20162773>
19. Moldovan, L. (2016). Training outcome evaluation model. *Procedia Technology*, 22, 1184-1190.
20. <https://doi.org/10.1016/j.protcy.2016.01.166>
21. Nda, M. M., & Fard, R. Y. (2013). The impact of employee training and development on employee productivity. *Global journal of commerce and management perspective*, 2(6), 91-93.
22. <https://doi.org/10.4236/jhrss.2015.34025>
23. Sharma, R. (2018). A Study on Training Need Analysis of Employees. *Amity Journal of Training and Development*, 3 (1), (22-35). Retrieved from
24. <https://scholar.google.com>

## **Identification, Screening of Heavy metal Resistant Bacteria and Bioremediation of Heavy Metals in Waste Water by using Different Bacterial Strains**

**Venkatesh Vangeapurapu and Alapati Krishna Satya\***  
Biotechnology Department, Acharya Nagarjuna University, India

### **ABSTRACT**

The heavy metals have no biological role they are well known for their toxicities, mutagenic, and carcinogenic impact on human beings and other living system they can enter the food chain through aqua life or agriculture which may have an effect on fish, birds and mammals, including humans, which migrate into different ecosystems. They may enter the human body through food, water, air or absorption through the skin when they meet humans in agriculture, manufacturing, pharmaceutical, industrial or residential settings. Heavy metals are toxic to soil, plants, aquatic life and human health when they are not metabolized by the system and accumulate in different parts of system. Several acute and chronic toxic effects of heavy metals on human body, such as Gastrointestinal and kidney dysfunction, nervous system disorders, skin lesions, vascular damage, immune system dysfunction, birth defects, and cancer, common toxic effects on plants, such as low biomass accumulation, chlorosis, inhibition of growth and photosynthesis, altered water balance and nutrient assimilation, and senescence, which ultimately cause plant death. And exhibit toxic effects towards soil microbes by affecting key microbial processes and decrease the number and activity of soil microorganisms. Bioremediation is a type of waste management technique which involves the use of microorganisms to remove or utilize the pollutants from a polluted area as it uses no toxic chemicals. Microorganisms like Bacteria are the most crucial microbes in this process as they break down the waste into nutrients and organic matter. In Bioremediation, the population of these helpful bacteria can be increased by adding nutrients. And bacteria are used because the reduction rate of heavy metals is often slow unless catalyzed by microbial interactions. Biodegradation requires microbial population with the metabolic capacity to degrade the pollutant. It can't be easy to explain the results from the lab studies into field operations. By the use of genetic engineering, we can create organisms like bacteria specifically designed for bioremediation. Two categories of genes can be inserted in the organism: the genes (degradative) which encode proteins required for the degradation of pollutants, and another genes (reporter) that are able to monitor pollution levels.

Keywords: Bioremediation, Heavy metals, contaminated water, Bio-sorption Efficiency, minimum inhibitory concentration, 16S rRNA.

### **INTRODUCTION**

In previous decades, the wastes were traditionally disposed by digging a hole and filling it with waste material. This mode of waste disposal was difficult due to lack of new place every time to dump. New technologies for waste disposal that use high-temperature incineration and chemical decomposition (e.g., base-catalyzed dechlorinating, UV oxidation) have evolved. New technologies can be very effective at reducing wide a range of contaminants but at the same time have some drawbacks. These methods are complex, uneconomical, and lack public of acceptance. The associated deficiencies in these methods have focused efforts towards harnessing modern day bioremediation process as a suitable alternative. The process of bioremediation mainly depends on microorganisms which enzymatically attack the pollutants and convert them to innocuous (safe) products. The bioremediation can be effective only where environmental conditions permit microbial growth and activity, environmental parameters and degradation to proceed at a faster rate. The microorganisms accumulate heavy metals in polluted water systems. In order to survive in heavy-metal polluted environments, many bacteria have developed resistance to toxic metal ions and most of them are known to have specific genes for resistance to toxic ions of heavy metals. The research activity in this area would contribute towards developing advanced bio process technology to reduce the toxicity of the pollutants and to obtain novel useful substances.

The research work on one of the mechanisms of bioremediation that is Bio-sorption which is a physical and chemical process that can be simply defined as the removal of substances from solution with the participation of microorganisms (Bacteria) by surface adsorption concerning the gathering of heavy metals on the cell surface. The other method relies on metal infiltration to the middle of the cell. It is often when bio-sorption occurs as the first phase of the following intracellular accumulation and the process of surface adsorption occurring very fast during several minutes may have a dominant role in metal linking to high metal accumulation in the cell. Metals are linked by active groups of compounds occurring in the surface layers of bacterial cells. This is the reaction

number of ions transfer between metal cations and active groups gifted with the negative potential of outer cell structures of bacteria, active in metal linking.

The research work on one of the mechanisms of bioremediation that is Biotransformation which are reactions of oxidation, reduction, methylation and demethylation by the enzymatic systems of microorganisms. Practically useful may be reactions of significantly toxic or valuable metal reduction, like bacteria caused the reduction of highly toxic chromium (VI) to less toxic chromium (III), which may be removed from the environment. Any bacteria can conduct a reduction of metal ions to metallic form may be in vacuoles, on the cell surface, and in the extracellular environment.

## **MATERIALS AND METHODS**

### **Collection of Wastewater Samples**

Wastewater samples collected from the least suspected contaminated area to the most suspected contaminated area like agriculture field outlets, canals, bore wells of industrial areas and outlets of industries in Andhra Pradesh. Placed the sample into labeled single-use vial and stored in an individual container. Distilled water taken as blank and heavy metal mixers were taken as test blanks.

### **Screening and Isolation of Heavy Metal Tolerant Bacteria**

The wastewater sample was serially diluted in which 9ml of sterile saline water in 10 test tubes and then 1ml of sample was added to the first test tube to have 10<sup>-1</sup> repeated up to 10<sup>-10</sup> then 0.1 ml of the dilution was spread on the surface of the nutrient agar plates where the metals were added and incubated at 37°C for 2-3 days, colonies differing in morphological appearance were selected for further studies and sub-cultured on the same media. After the bacterial growth, added 500 µL of the overnight culture to 500 µL of 50% glycerol in a 2 mL cryovial and gently mix to make glycerol stock. Freeze the glycerol stock tube at -80°C. The stock is now stable for years, if it is kept at -80°C.

To determine tolerance, bacterial strains were aseptically streaked on nutrient agar plates supplemented with 10 mg/L to 300 mg/L (10mg, 20mg, 30mg, 40mg, 50mg, 100mg, 150mg, 200mg, 250mg, 300mg per 1 Liter concentrations) of Cadmium Sulphate (CdSO<sub>4</sub>), Potassium Dichromate (K<sub>2</sub>Cr<sub>2</sub>O<sub>7</sub>), Copper Sulphate (CuSO<sub>4</sub>.5H<sub>2</sub>O), Nickel Chloride (NiCl<sub>2</sub>.6H<sub>2</sub>O) And Lead Chloride (PbCl<sub>2</sub>) incorporated LB (Luria Bertani) agar plates (Peptone 10 g/L, yeast extract, 5 g/L, NaCl 5 g/L, dextrose anhydrous 10 g/L and agar 30 g/L: pH-7.00) were used and screened by standard pour plate method observed at 37°C.

After preliminary screening of effluent samples containing heavy metal degrading bacteria, Streak plate technique was followed during isolation. Control plates were prepared with LB media without heavy metal to make comparison in morphological characteristics.

In this study, a total of 6 bacterial strains able to grow in the presence of toxic metals. They were *Escherichia coli*, *Salmonella typhi*, *Bacillus licheniformis*, *Bacillus thuringiensis*, *Pseudomonas aeruginosa* and *Pseudomonas putida*

### **Heavy Metal Stock Solutions**

A separate stock solution of CdSO<sub>4</sub>, K<sub>2</sub>Cr<sub>2</sub>O<sub>7</sub>, CuSO<sub>4</sub>.5H<sub>2</sub>O, PbCl<sub>2</sub> and NiCl<sub>2</sub>.6H<sub>2</sub>O was prepared in 100ml capacity flask by dissolving appropriate quantities (10 mg/L to 300 mg/L) of pure metal powders in 1% nitric acid with double distilled water.

### **Initial Heavy Metal Concentration**

To evaluate the effect of heavy metal concentration on bacterial biomass the initial heavy metal concentration is important. Active binding sites and functional groups, available on the bacterial surface, are affected by the initial concentration of metal ions. Higher concentrations of heavy metals possess higher toxicity for bacterial biomass. The bio-sorption efficiency of seven heavy metals was taken for Cd, Cu, Ni, Pb and Cr.

### **Determination of Minimum Inhibitory Concentration (MIC)**

To observe the minimum inhibitory concentration, bacteria isolates were grown on heavy metal incorporated media against respective heavy metal. It was identified by gently inclining the concentration of the heavy metals on LB agar plates until the isolates failed to give colonies on the petri plate concentration of the heavy metals was from 50 µg/mL to 3000 µg/mL and MIC was determined at 37°C after 24hrs.

### **Bio-Sorption Efficiency**

A batch equilibrium method (Khodaverdiloo and Samadi, 2011) was used to determine the sorption of Cadmium, Chromium, Copper, Nickel and Lead by *Escherichia coli*, *Salmonella typhi*, *Bacillus licheniformis*, *Bacillus thuringiensis*, *Pseudomonas aeruginosa* and *Pseudomonas putida*.



All set of experiments was done in fixed volume (100 ml) of metal ions contaminated solution in a 250 ml Erlenmeyer flask. Bacterial biomass was exposed to metal solutions (for 72 hrs.) on an orbital shaking incubator at 160 rpm. Biomass was separated by centrifugation at 8000rpm for 15 min. and the supernatant was analyzed for residual metal concentration by analytical spectrophotometer.

Measurement of metal uptake by the bio-sorbent was calculated as:

$$Q = \frac{V(C_i - C_f)}{M}$$

Where,

Q = Metal ion uptake capacity

C<sub>i</sub> = Initial concentration of metal in the sorption

C<sub>f</sub> = Final concentration of metal in the sorption

M = Dry weight of bio-sorbent

V = Solution volume

The difference between the initial metal ion concentration and final metal ion concentration was considered as metal bound to the bio-sorbent. The higher the bio-sorption capacity, the higher the amount of heavy metal ions can bio-sorb by bacteria, under optimum pH of media and temperature

### 16S Rrna Based Identification of the Heavy Metal Resistance in the Selected Bacterial Samples

In all microorganisms, 16S rRNA is considered as the highest quality level for describing phylogenetic similarities among microbial communities. It can be used for a complete assessment of microbial diversity. The bioremediation processes can be determined by investigating the 16S rRNA sequences obtained from contaminated environments. Kou et al. (2018) reported 16S rRNA gene amplicon sequencing to study the abundance and diversity of the microbial community in soil polluted with heavy metals like lead, zinc and copper.

### Physical & Chemical Parameters

The physicochemical parameters were measured using standard methods. The physical & chemical parameters of the wastewater samples were 1. Turbidity, 2. Centrifugation, 3. Dissolved Oxygen (DO) profile, 4. Oxygen uptake rate (OUR), 5. pH, 6. Conductivity, 7. Color, 8. Temperature, 9. BOD.

### RESULTS AND DISCUSSION:

The bacterial strains were aseptically streaked on nutrient agar plates which were supplemented with heavy metals in respective concentrations. After incubation (24 hrs.) the plates were observed for growth of bacteria on the culture medium.

### Determination of Minimum Inhibitory Concentration (MIC)

The bacteria isolates were grown on media against respective heavy metal. The growth was identified more when the concentration was least (50 µg/mL) and the isolates failed to give colonies on the petri plate concentration of the heavy metals was very high (3000 µg/mL) and MIC data was taken where the lowest concentration of heavy metal inhibited growth of bacteria at 37°C after 24hrs. MIC of heavy metals showed high tolerance to Pb, by the selected six bacterial strains.

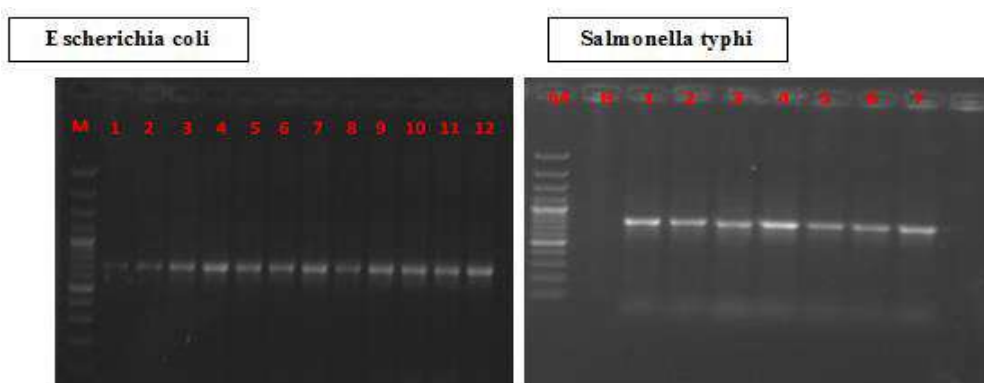
Minimum inhibitory concentration (MIC) is the lowest concentration at which isolate is completely suppressed bacterial growth was recorded. In this study order of MICs for the selected six bacterial strains was found to be Cd > Pb > Cu > Cr > Ni - for the *Escherichia coli*. It was resistant against Cd with MIC of 150 µg /mL, Cr, Ni with MIC of 300 µg /mL has been recorded. Here demonstrated that *Bacillus*, *Pseudomonas sp.* bacteria are resistant to heavy metals (Pb, Cu, Ni, Cd); *Pseudomonas sp.* bacteria were found to the most multiple heavy metals resistant with MIC against Pb (1900 µg /mL), Cr (600 µg /mL) and Cd (1500 µg /mL). Among six bacterial strains, *Escherichia coli* was identified here as the lowest capacity of Pb and Cr against respective heavy metal.

	<b>Escherichia coli</b>	<b>Salmonella typhi</b>	<b>Bacillus licheniformis</b>	<b>Bacillus thuringiensis</b>	<b>Pseudomonas aeruginosa</b>	<b>Pseudomonas putida</b>
<b>Cd</b>	150	500	250	150	1500	1200
<b>Cr</b>	300	250	350	300	600	500
<b>Cu</b>	250	200	1000	1500	1200	1500
<b>Ni</b>	300	400	600	500	1000	1200
<b>Pb</b>	200	500	1800	1600	1900	1800

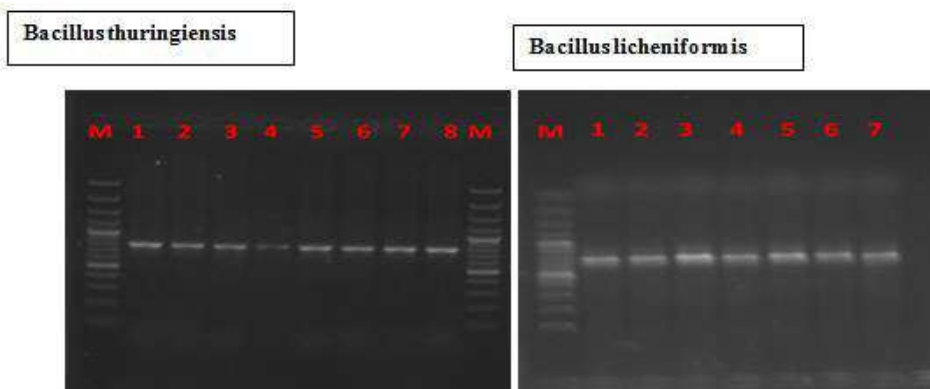
### 16S RRNA Based Identification of the Heavy Metal Resistance in the Selected Bacterial Samples

In all microorganisms, 16S RRNA is considered as the highest quality level for describing phylogenetic similarities among microbial communities. It can be used for a complete assessment of microbial diversity. The bioremediation processes can be determined by investigating the 16S RRNA sequences obtained from contaminated environments. Kou et al. (2018) reported 16S rRNA gene amplicon sequencing to study the abundance and diversity of the microbial community in soil polluted with heavy metals like lead, zinc and copper.

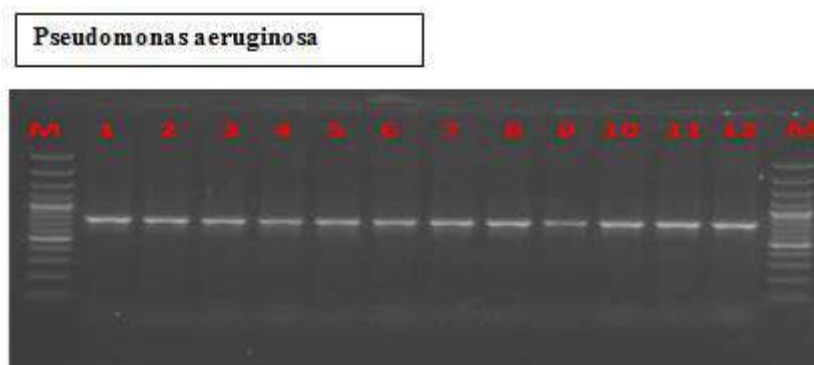
The primer sets used for 16S rRNA gene amplification of the selected six bacterial strains. All primer sets were synthesized by Invitrogen BioServices India Pvt. Ltd, Whitefield, Bangalore. A total volume of 25  $\mu$ L of a reaction mixture of forward and reverse primer (0.5  $\mu$ L of each), DNA template (1  $\mu$ L), 2X master mix (12.5  $\mu$ L) (Biolab, England), and 11  $\mu$ L nuclease free water was used for the Polymerase Chain Reaction (PCR). PCR was performed using a thermal cycler (Bio-Rad) and the PCR products were analyzed on 1% (w/v) agarose gel supplemented with 10  $\mu$ L EtBr and done electrophoresis. 1Kb molecular marker was used to determine the band size of the amplicons



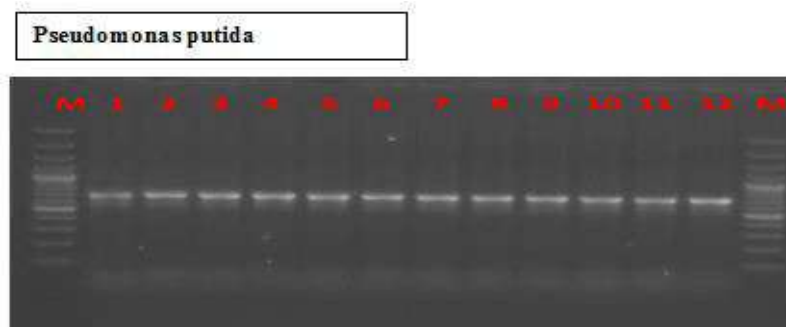
M stands marker, Lane 1 to 12 and 1 to 7 shows 16S rRNA gene in different isolates of Escherichia coli and Salmonella typhi



M stands marker, Lane 1 to 8 and 1 to 7 shows 16S rRNA gene in different isolates of Bacillus thuringiensis, Bacillus licheniformis



M stands marker, Lane 1 to 12 shows 16S rRNA gene in different isolates of Pseudomonas aeruginosa



M stands marker, Lane 1 to 12 shows 16S rRNA gene in different isolates of *Pseudomonas putida*

### Bio-Sorption Efficiency

All set of experiments was done in fixed volume (100 ml) of metal ions contaminated solution in a 250 ml Erlenmeyer flask. Bacterial biomass was exposed to metal solutions for 3 days in orbital shaking incubator at 150 rpm. The bacterial biomass was separated by centrifugation at 8000rpm for 15 min. and the supernatant was analyzed for residual metal concentration by analytical spectrophotometer.

The initial metal ion concentration of chromium was high (1950 µg /L) and Nickel was low (100 µg /L) in sample. After incubation the metal ion uptake capacity was *E. coli* < *S. typhi* < *B. thuringiensis* < *B. licheniformis* < *P. putida* < *P. aeruginosa*. *Pseudomonas aeruginosa* showed higher the bio-sorption capacity like Cadmium > Lead > Copper > Nickel > Chromium under optimum pH of media and temperature.

Bacterial isolates	Type of Heavy Metal	Initial Heavy Metal ion concentration (µg /L)	Final Heavy Metal ion concentration (µg /L)	Dry Weight (mg)	Metal ion uptake capacity (Q)
Escherichia coli	Cadmium	120	80	600	67
	Chromium	1950	1360	7500	79
	Copper	450	310	2200	64
	Nickel	100	70	450	67
	Lead	150	110	600	67
Salmonella typhi	Cadmium	120	85	500	70
	Chromium	1950	1320	8800	71
	Copper	450	280	2400	71
	Nickel	100	75	350	71
	Lead	150	105	650	69
Bacillus licheniformis	Cadmium	120	90	400	75
	Chromium	1950	1250	8500	82
	Copper	450	320	1400	93
	Nickel	100	80	250	80
	Lead	150	90	700	86
Bacillus thuringiensis	Cadmium	120	85	450	78
	Chromium	1950	1170	9200	85
	Copper	450	300	1800	83
	Nickel	100	80	250	80
	Lead	150	80	850	82
Pseudomonas aeruginosa	Cadmium	120	100	200	100
	Chromium	1950	1460	5500	89
	Copper	450	315	1300	104
	Nickel	100	85	100	150
	Lead	150	120	250	120
Pseudomonas putida	Cadmium	120	100	150	133
	Chromium	1950	1540	4200	98
	Copper	450	325	1200	104
	Nickel	100	85	150	100
	Lead	150	120	250	120

### Physical & Chemical Parameters

The physicochemical parameters were measured using standard methods. The physical & chemical parameters of the wastewater samples were 1. Color, 2. Temperature, 3. pH, 4. Turbidity, 5. TDS, 6. TSS, 7. DO, 8. COD, 9. BOD.

### Physical & Chemical Parameters of Effluent Sample

S.No	Parameters	Effluent
1	Color	Pale Reddish brown
2	Temperature	37°C
3	pH	5.1
4	Turbidity	9.4 ntu
5	Total Dissolved solids	20 mg/l
6	Total suspended solids	28 mg/l
7	Dissolved Oxygen	8 mg/l
8	COD	65.5 mg/l
9	BOD	33 mg/l

### CONCLUSION

The biomass of metal tolerant bacteria *Escherichia coli*, *Salmonella typhi*, *Bacillus licheniformis*, *Bacillus thuringiensis*, *Pseudomonas aeruginosa* and *Pseudomonas putida* successfully removed the metals such as Cd, Cr, Cu, Pb and Ni from mixed wastewater which brought from industrial effluents. The bio-sorption of heavy metals by the bacterial was affected by initial metal concentrations, pH, and contact time (72 hrs.).

According to the pooled data *Pseudomonas aeruginosa* showed higher the bio-sorption capacity on different heavy metals at pH 5.1 within 72Hrs at 37± 2°C. The functional groups included amino, carboxyl, hydroxyl and carbonyl groups, which could possibly be involved in the bio-sorption of Cd, Cr, Cu, Pb and Ni.

### ACKNOWLEDGMENT

We give glory to my parents and family members for the blessings bestowed upon us. Very much thankful to Faculty of Biotechnology Department, Acharya Nagarjuna University, Guntur for their Guidance and assistance during my study.

### REFERENCES

1. APHA. Standard Methods for the Examination of Water and Wastewater. 21<sup>st</sup> ed. American Public Health Association. Washington, DC. Part, (2005). 8000, 94-100.
2. Gabr, R.M., Hassan, S.H.A., Shoreit, A.A.M., 2008. Biosorption of lead and nickel by living and nonliving cells of *Pseudomonas aeruginosa* ASU 6a. Int. Biodeterior. Biodegrad. 62, 195–203.
3. Horsfall, M., Spiff, A.I., 2005. Effect of metal ion concentration on the biosorption of Pb<sup>2+</sup> and cadmium Cd<sup>2+</sup> by *Caladium bicolor* (wild cocoyam). Afr. J. Biotechnol. 4, 191–196.
4. Javed, M., Usmani, N., 2019. An overview of the adverse effects of heavy metal contamination on fish health. Proc. Natl. Acad. Sci. India B Biol. Sci. <https://doi.org/10.1007/s40011-017-0875-7>.
5. Khodaverdilo, H., Samadi, A., 2011. Batch equilibrium study on sorption, desorption, and immobilisation of cadmium in some semi-arid zone soils as affected by soil properties. Soil Res. 49, 444–454.
6. Lodeiro, P., Barriada, J.L., Herrero, R., Sastre deVicente, M.E., 2006. The marine macroalga *Cystoseira baccata* as biosorbent for cadmium (II) and lead (II) removal: kinetic and equilibrium studies. Environ. Pollut. 142, 264–273.
7. Oves, M., Khan, M.S., Zaidi, A., 2013. Biosorption of heavy metals by *Bacillus thuringiensis* strain OSM29 originating from industrial effluent contaminated north Indian soil. Saudi J. Biol. Sci. 20, 121e129. <https://doi.org/10.1016/j.sjbs.2012.11.006>.
8. Pabst, M.W., Miller, C.D., Dimkpa, C.O., Anderson, A.J., McLean, J.E., 2010. Defining the surface adsorption and internalization of copper and cadmium in a soil bacterium, *Pseudomonas putida*. Chemosphere 81, 904–910.
9. Pandit, R., Patel, B., Kunjadia, P., & Nagee, A. Isolation, characterization and molecular identification of heavy metal resistant bacteria from industrial effluents, Amala-khadi Ankleshwar, Gujarat. Inter J Environ Sci, (2013); 3(5), 1689-1699.

10. Pandiyan, S., Mahendradas, D., 2011. Application of bacteria to remove Ni (II) Ions from aqueous solution. *Eur. J. Sci. Res.* 52, 345–358.
11. R. Singh, P. Singh, R. Sharma, Microorganism as a tool of bioremediation technology for cleaning environment: A review, *Intrnational Academy of Ecology and Environmental Science*, 4 (1), 2014, 1-6.
12. Rafiqullah, I.M., Hossain, A.M.M., Ilias, M., Hoq, M.M., 2008. Chromium (VI) reducing native microorganisms for remediation of chromium eco-toxicity in environment of Bangladesh. *Bang. J. Sci. Ind. Res.* 43, 455–466.
13. Sar, P., Kazy, S.K., Asthana, R.K., Singh, S.P., 1999. Metal adsorption and desorption by lypholized *Pseudomonas aeruginosa*. *Int. Biodeterior. Biodegrad.* 44, 101–110.
14. Singh, R., Gautam, N., Mishra, A., Gupta, R., 2011. Heavy metals and living systems: an overview. *Indian J. Pharmacol.* <https://doi.org/10.4103/0253-7613.81505>.
15. Shivakumar, C.K., Thippeswamy, B., Krishnappa, M., 2014. Optimization of heavy metals bioaccumulation in *Aspergillus niger* and *Aspergillus flavus*. *Int. J. Environ. Biol.* 4 (2), 188–195.
16. S.P.B.K. Kamaludeen, K.R. Arunkumar, S. Avudainayagam, K. Ramasamy, Bioremediation of chromium contaminated environments, *Ind. J. Exp Bio.* 41, 2003, 927-985.
17. Srivastava, J., Chandra, H., Tripathi, K., Naraian, R., & Sahu, R. K. Removal of chromium (VI) through biosorption by the *Pseudomonas* spp. isolated from tannery effluent. *J Basic Microbiol*, (2008). 48(2), 135-139. doi: 0.1002/jobm.200700291
18. Sunder, K., Vidya, R., Mukherjee, A., Chandrasekaranc, N., 2010. High chromium tolerant bacterial strains from Palarbriver basin: impact of tannery pollution. *Res. J. Environ. Earth Sci.* 2, 117–122.
19. Virender, S., Chauhan, P.K., Kanta, R., Tejpal, D., Vinod, K., 2010. Isolation and characterization of *Pseudomonas* resistant to heavy metals contaminants. *Int. J. Pharm. Sci. Rev. Res.* 3 (2), 164–167.
20. Volesky, B., 1990. Removal and recovery of heavy metals by biosorption. In: Volesky, B. (Ed.), *Biosorption of Heavy Metals*. CRC Press, Boca Raton, pp. 7–44.
21. Volesky, B., Holan, Z.R., 1995. Biosorption of heavy metals. *Biotechnol. Progr.* 11, 235–250.
22. Zoubolis, A.I., Loukidou, M.X., Matis, K.A., 2004. Biosorption of toxic metals from aqueous solution by bacteria strains isolated from metal polluted soils. *Process Biochem.* 39, 909–916.

## **Impact of Social Media on Interpersonal Communication in Uttar Pradesh**

**Chhaya Bjpai and Sita Devi**

School of Humanities & Arts, MUIT, Lucknow, U.P, India

### **ABSTRACT**

Social networking phenomenon has emerged over the last few years. Social networking sites have grown from a niche to a mass online activity, in which millions of internet users are engaged, both in their leisure time, and at work. On one side these sites facilitate communication with our dear ones and also these websites can be useful for education based on sound pedagogical principles and under proper supervision by the teachers while on the other hand it creates platform for many cyber crimes, distracts students from their studies. The impact of these social networking sites on the youth of India is both positive as well as negative. Internet medium is developing with the increased usage and understanding of how to use e-mails, shopping online, and searching the web for recipes or looking out for the long- lost instruction manual for a piece of equipment in the garage etc. Now, internet is more about blogs, podcasts, Facebook, Myspace, and Whats App. These are some of the tools and technologies associated with a recent phenomenon called social networking and is present everywhere. Against this backdrop present paper attempts to examine the impact of social media on interpersonal communication and relations. The paper is based on mainly primary data collected through field survey in Lucknow city.

### **INTRODUCTION**

Social networking phenomenon has emerged over the last years. Social networking sites have grown from a niche to a mass online activity, in which millions of internet users are engaged, both in their leisure time, and at work. Social networking websites like Orkut, Facebook, Myspace and Youtube are becoming more and more popular and has become part of daily life for an increasing number of people. Young people are attracted to social networking sites. No doubt these social networking sites provides employment, marketing, personal growth, sharing of information but the most prevalent danger through often involves online predators or individuals. These social networking sites have great impact on youth. One can easily see the entry gate of these social networking sites but it is unable to find exit for these social networking sites. One side these sites provide to communicate with our dear ones websites can be useful for education based on sound pedagogical principles and proper supervision by the teachers on the other side it creates platform for many cyber crimes, and also distracts students from their studies. Several research studies have revealed that social media technologies such as Facebook, Twitter, blogs, wikis, Flickr, and YouTube have garnered more than a billion users across the world and have redefined the modern business. Modern universities and Colleges are making consistent efforts to utilize the support of social media in reaching the existing customers, attracting the new customers and building credibility and reputation of their brand image. Research studies further revealed that these educational institutional brands need to measure their visibility in the most popular social media relative to that of competitors. Social media is influencing every walk of life including social relations, society, politics, economic and business.

### **REVIEW OF LITERATURE**

Abbas and Singh (2014) opined that media industry in 2014 has moved away from traditional print and audio-visual domination and into the digital age with smart phones being the key to ushering in innovative technology, creativity and high-speed communication. Manjunath (2013) said that the usage of Social Networking Sites (SNS) has significantly increased in India particularly among the Indian college students and it certainly has far reaching impacts on the academic and other activities of the students. Kavita (2015) has highlighted that in the last few years, social network media have spread widely all over the world and are used by various users for several reasons and purpose. Jain (2017) has highlighted that social media is considered as ultimate tool of marketing communication. It connects with online arena and spread the information of products and services. Ahmed (2011) opined that social network offers people great convenience for social networking. It allows people to keep in touch with friends, reconnect with old friends, meet new people, and even conduct business online. The social network is rising not even in India, all over the World. Deshmukh et.al (2014) opined that online social networking has achieved an exceptional global growth over the last decade by attracting much attention from all age group people. It is a known fact that young adults and teenagers are the most avid users of such sites. Jothi et.al (2011) highlighted that Internet is the emerging information technology with the credibility of immediacy and fastness, thus, it brings globalization in every aspects of communication. Communication through internet is more specified, with effective interactive strategy among its users. In recent days, internet advertising has taken new forms which have more advantages over the traditional mediums like

print media, television and radio. Marketing communication is becoming precise, personal, interesting, interactive and social. Different strategies of communication are followed in various social networking sites like Face book, Twitter and Orkut. Bhagwat and Gautam (2013) said that social networks are groups of people, or communities, who share a common interest, perspective, or background. Mathew (2013) opined that the period of 2010 to 2013 has been an eventful period for social media. Several new networking sites became popular (WhatsApp, Google Plus, Instagram), the usage base grew by leaps and bounds, and Facebook bought over some of its competition. The growth of social media along with the rapid growth of smart phone usage has also made a great impact on various facets of our lives. Siddiqui and Singh (2013) highlighted that Social media plays a vital role in transforming people's life style. Social media includes social networking sites and blogs where people can easily connect with each other. Since the emergence of these social networking sites like Twitter and Facebook as key tools for news, journalists and their organizations have performed a high-wire act. Bhardwaj et. al (2017) highlighted that the extensive use of Social Networking in India has been on the rise among the new generation youths. In today's world, life cannot be imagined without Facebook, YouTube, Instagram, WhatsApp, LinkedIn or Twitter accounts and online handles. Isodje (2014) presented an overview on the use of social media for business promotion, since social media as an online collaborative platform has the power to impact cultures and business. Mamta et al. (2016) tested for affiliation that exists between Higher Education and Social Networking Site. Purva et al. (2015) presented that online social networking like Facebook and Twitter have the fastest means of communication and having gained wide popularity, have revolutionized interpersonal communications by providing a platform to individuals for expressing themselves at a global level, beyond their immediate geography. Davmane et al. (2015) analyzed the factors for the online social networking sites as per users' behavior regarding user friends, the peer groups, access patterns, amount of time spend, the effect on personal and professional life. Singh et al. (2014) presented the research effort in ensuring awareness about the social networking site concept, merits, demerits and meaning. Purti et al. (2016) focused on Big Data Management for Social Networking Sites by review and analysis of how Big Data is being managed for social networking sites by Facebook and Twitter. Kumar et al. (2016) proposed a sentiment analysis method on the tweets in Cloud environment and utilized Hadoop for intelligent analysis and storage of big data on Facebook and Twitter. The reason is that handling huge amount of unstructured data is a tedious task to take up. The current Analytics tool and models used that are available in the market are not sufficient to manage big data. Mittal et al. (2016) analyzed the effects of online shared sentiments of emoticons, interjections and comments extracted from posts and status updates. Shang et al. (2015) investigated why and how people use location sharing services on social networking platforms in China. Muhammed et al. (2017) reviewed research papers from 2010 to 2016 on Sybil attacks regarding use of fake and malicious identities on the online social network. Zhou et al. (2017) proposed a unique system called Pro Guard for detecting malicious identity accounts in financial institutions dealing online with real and virtual currency. Kiliror et al. (2017) presented a trust analysis system for online social networks to improve privacy and approval process for authentic social network site users. Wang et al. (2016) proposed use of a probabilistic model for detecting identity thefts on social networking when using mobiles over unsecure Internet. Baruah (2012) highlighted that social media can be effective for building social authority; individuals or organizations can establish themselves as experts in their fields, and then they can begin to influence these fields. Jain and Gupta (2012) opined that social networking sites provide a platform for discussion on such issues as it is this media which majority mass rely on and extend warm support. Parvathi and Suchitra (2015) have made detailed analysis of what activities the youth population involved with social networking sites. Sarkar et. al. (2015) opined that social networks have undergone an intense evolution in recent years.

#### **OBJECTIVES AND METHODS**

- To study the accessibility, affordability and exposure of information technology and social networking sites among the students pursuing higher education;
- To study the mode, usage and timings of engagement of students in social media ;
- To examine the attitudinal change among the students regarding information technology and social media, social networking sites and interpersonal relationships.

The present paper is based on a major research study. The study is empirical in nature and based on mainly primary data collected through field survey. Lucknow city has been selected in the study. Overall, about 500 students pursuing different courses from higher education institutions were surveyed with the help of structured interview schedule.

## DISCUSSION OF RESULTS

Lucknow being the state capital, there are a number of educational institutions including universities, postgraduate colleges and other academic institutions. State, Central, Private and Medical universities were selected in the sample of study. However, about 48 per cent respondents were from State University. The overwhelming majority of respondents were from government institutions. Slightly more than 1/3<sup>rd</sup> respondents were from rural background while about 30 per cent respondents were females. About 86 per cent respondents were from Hindu communities and mainly from General and OBC communities. The overwhelming majority of respondents were from the low age group i.e. less than 25 years. About half of the respondents were postgraduates while slightly less than 2/5<sup>th</sup> respondents were undergraduates and graduates. About 22 per cent respondents reported that they are receiving fellowship/scholarship. Majority of the respondents reported that their institutes have adequate number of computer for students.

About 2/3<sup>rd</sup> respondents further reported that internet connectivity is available to them. About 62 per cent respondents further revealed that their institutes have arranged appropriate software and subscribed online journals, books and periodicals. Majority of respondents reported that the institutes are using computerized system for issuing of library resources. However, online access to library stock was reported by 45 per cent respondents. Access to desktop computers, laptops, printers, smart mobile phones, pen drive/USB stick and digital camera was reported satisfactory however; accessibility to webcam, wireless internet, broad band internet connection and scanner was reported to be low. About half of the respondents reported that their institutes are supporting them in accessing of computer and internet facility. However, majority of the respondents reported that they are getting access to ICT for learning at home, libraries, computer labs and class rooms. About 2/5<sup>th</sup> respondents reported that computers in computer labs for students are not adequate. Similarly, the arrangement of appropriate software is not adequate in their institutes/colleges. Thus, about 58 per cent respondents revealed that they are getting maximum access to internet at home. Almost all the respondents reported that they have active account in social media. The social media accounts were reported mainly Whats App, Facebook, Youtube, Twitter, Skype and LinkedIn. Internet services as per priority of use were reported to be search and downloading, social networking, chatting, conferencing, gaming, e-communication and online shopping.

Most of the respondents are consuming internet data less than 4 GB per day. The overwhelming majority of the respondents reported that they are using internet frequently and regularly. Voice mail, internet, search, social networking, SMS, Video, Music, FM radio, news and GPRS were some of the most preferred services being used by mobile phones. Majority of the respondents revealed that they have associated with less than 10 social networking sites. More than 3/4<sup>th</sup> respondents revealed that they are getting access to social networking sites through their smart phones. More than half of the respondents reported that they are spending less than 2 hours daily on social networking sites. About 2/5<sup>th</sup> respondents had contact of less than 50 persons on their social networking sites while about 60 per cent respondents had more than 50 persons in their contacts on social networking. Finding information, keeping in touch with family and friends, making new friends, making professional and business contacts, sharing images and videos, gaming and sharing experience were the major usages of online social networking. About 2/3<sup>rd</sup> respondents were of the view that online networking has affected their social life. Most of respondents opined that social networking is important for them. Most of the respondents admitted that social networking sites are affecting adversely their social relations. Most of the respondents reported that social media has replaced traditional mode of communication. It has emerged as effective tool for e-learning and educational development. Majority of the respondents reported that social networking sites are affecting their personal life and their study.

## CONCLUSION

The use of information technology in society and particularly educational institutions has become the fashion today. It has proved to be the most effective mode and delivery mechanism. The educational programmes highlight on the new models, approaches and modes for developing educational contents, conducting of programmes, and delivery of educational inputs. Besides, effective use of technology in education sector has widened the scope and nature of institutions with cost effective mechanism of administration, monitoring and evaluation of performance. Even, use of ICTs in education sector has improved the quality of education and more accessible to the target population. The application of information technologies in education system has become common now days The use of ICTs in the higher education system has been also encouraged in the New Education Policy while COVID-19 pandemic has forced educational institutions to think beyond traditional boundaries of education. Thus, online mode of teaching, training and sessions of seminar, examinations, and via voice are being conducted. This may depend upon various factors including existence of



ICT equipped labs, workshops, classroom and library; student's their background, nature of subject etc. The e learning process is gaining importance.

### SUGGESTIONS

- λ Infrastructure of higher education institutions should be developed and further strengthened. Students find computer laboratory, communication facility (such as telephone, fax, e-mail etc.), and electricity supply, as inadequate. These facilities should be made more and more accessible to both the teachers and students.
- λ Library resources especially e-journals, other periodicals, textbooks, other reference books, audio–videocassettes etc. need to be further enriched. They must be made more and more accessible to the students. Librarians of these institutions need to shed away their “close access” approach to work and display of literature and information resources.
- λ Computer-based teaching, learning and training have vast scope for improving the quality and access of education in higher education institutions. However, e-learning requires improvement in content, services, mode of delivery of knowledge and educational infrastructure. Video conferencing, video lectures, e-lectures, online courses, etc. may replace traditional mode of teaching and training.
- λ Internet facilities and wi fi should be available in all the higher education institutions providing professional education while smart classrooms are required for students so that students get access learning materials through using wi fi and may interact effectively with faculty members.

### REVERENCES

1. Abbas, Shirin and A. K. Singh (2014) Media Industry Trends and Dynamics: The Social Media Boom Social and Behavioural Sciences , 155
2. Ahmad, Ateeq (2011) A Short Description of Social Networking Websites and Its Uses ,International Journal of Advanced Computer Science and Applications, Vol. 2, No.2, February
3. Baruah, Trisha Dowerah (2012) Effectiveness of social Media as a Tool of Communication and its potential for technology enabled connections, International Journal of Scientific and Research Publications, Volume 2, Issue 5, May
4. Bhagwat , S and Gautam , A (2013) Development of Social Networking Sites and Their Role in Business with Special Reference to Facebook, Journal of Business and Management, Volume 6, Issue 5
5. Bhardwaj A et. al (2017) Impact of Social Networking on Indian Youth - A Survey International Journal of Electronics and Information Engineering, Vol.7, No.1
6. Deshmukh, Pooja et. al (2014) An Impact Of Social Networking Sites On Youngsters, International Journal of Management , Volume 5, Issue 12, December
7. Devmane, M, and N. Rana,(2015) Usability Trends and Access of Online Social Network by Indian population and its analysis," in International Conference on Nascent Technologies in the Engineering Field
8. Isodje, A, (2014) The use of Social Media for Business Promotion," in International Conference on Emerging & Sustainable Technologies for Power & ICT in a developing society,
9. Jain , M. R and Gupta , P ( 2012) Impact Of Social Networking Sites In The Changing Mindset Of Youth On Social Issues A Study Of Delhi-NCR Youth, Research World Journal of Arts ,Science and Commerce, Vol3, Issue 2
10. Jain , S (2017) Study of Social Media Impact On Indian Scenario, Asia Pacific Journal,
11. Joshi, P. S. et. al (2011) Analysis of social networking sites: A study on effective communication strategy in developing brand communication, Journal of Media and Communication Studies Vol. 3(7),
12. Kavitha (2015) The Influence Of Social Media On Indian Students and Teenagers, International Journal of Advance Research In Science And Engineering, Vol. No.4, Special Issue (01), April
13. Killoor, C. C. and C. Valliyammai,(2017) Trust analysis on social networks for identifying authenticated users," in IEEE 8th International Conference on Advanced Computing

14. Kumar, Senthil N et al (2015) On Privacy and Security in Social Media – A Comprehensive Study, presented in International Conference on Information Security & Privacy 11-12 December 2015, Nagpur, India
15. Manjunatha S. (2013) The Usage of Social Networking sites Among the College Students in India ,International Research Journal of Social Sciences, Vol. 2(5), 15-21, May
16. Mathews , S. P and George, S ( 2013) Growth and Future of Social Media, International Journal of Advanced Research in Computer Engineering & Technology, Volume 2, Issue 12, December
17. Mittal, S A. Goel, R. Jain, (2016) Sentiment analysis of E-commerce and social networking sites," in 3rd International Conference on Computing for Sustainable Global Development (INDIACom'16),
18. Mohamed, Haneefa K. and Sumitha, K.( 2011) "Perception and Use of Social Networking Sites by the Students of Calicut University". DESIDOC Journal of Library and Information Technology, 31, 4; 295-301
19. Parvathi , J and Suchitra , R ( 2015) Impact of Usage of Social Networking Sites on Youth, International Journal of Computer Applications ,Volume 129 – No.3, November
20. Purti , B . et. al (2015) Comparative Analysis Of Big Data Management For Social Networking Sites, presented in Third International Conference on Computing for Sustainable Global Development , 16-18 March , IEEE Access, New Delhi
21. Purva, P. et. al. (2015) How Has Twitter Changed the Event Discussion Scenario? A Spatio-temporal Discussion Analysis," in International Congress on Big Data (Big Data Congress'15), IEEE
22. Sarkar, Anurag et. al (2015) Impacts of Social Networks: A Comprehensive Study on Positive and Negative Effects on Different Age Groups in a Society, International Journal of Advance Research in Computer Science and Management Studies, Volume 3, Issue 5, May 2015
23. Shang S. C et. al (2015) Generating Consumer Resonance for Purchase Intention on Social Network Sites, Computer in Human Behavior, Vo.69
24. Siddiqui, S and Singh, S (2016) Social Media its Impact with Positive and Negative Aspects, International Journal of Computer Applications Technology and Research ,Volume 5– Issue 2,
25. Singh, K. P. and Gill, Malkeet Singh. 2011. "Use of Social Networking Sites By The Research Scholar; A Study of Guru Nanak Deve University, Amritsar". Library Herald, 49, 3; 229- 241.
26. Wang, C. and Bo Yang, J. Luo,(2017) Identity Theft Detection in Mobile Social Networks Using Behavioral Semantics," in IEEE International Conference on Smart Computing
27. Zhou, Y. at al., (2017) Accounts in Social-Network-Based Online Promotions," IEEE Access, Vol. 5,

---

---

## **Internet Dependency and Use of Ict among Students: A Study of Higher Education Institutions in Uttar Pradesh**

**Bhavna Dubey and Sita Devi**

School of Humanities & Arts, MUIT, Lucknow, U.P, India

### **ABSTRACT**

The rapid economic growth leading to demand for skilled human resource and enhance to competitiveness of Indian industries in a globalized economy has made the higher education sector a priority sector today. There has been phenomenal growth in private academic institutions providing higher education in traditional and professional disciplines and courses. Use of ICT in higher education has become integral part of education; however variations in purpose and frequency its use are seen among students. The use of ICT in education not only improves classroom learning process, but also provides the facility of e-learning. ICT has enhanced distance learning. In view of this, present study has attempted to examine the role of ICT in higher education in the state of Uttar Pradesh.

### **INTRODUCTION**

ICT is technology which supports activities encompassing information including gathering, processing, storing and presenting data. Significantly these activities also involve collaboration and communication. Information and Communication Technologies comprises of the hardware, software, networks, and media for collection, storage, processing, transmission and presentation of information (voice, data, text, images), as well as related services. ICTs may be divided into two components viz. information and communication infrastructure which are referred to physical telecommunications systems and networks (cellular, broadcast, cable, satellite, postal) and the services which utilize those (Internet, voice, mail, radio, and television), and information technology which refers to the hardware and software of information collection, storage, processing, and presentation. Information and communication technologies are conceptualized as all devices, tools, content, resources, forums, and services, digital and those which can be converted into or delivered through digital forms, and may be deployed for realizing the goals of teaching learning, enhancing access to and reach of resources, building of capacities, as well as management of the educational system. These technologies will not only include hardware devices connected to computers, and software applications, but also interactive digital content, internet and other satellite communication devices, radio and television services, web based content repositories, interactive forums, learning management systems, and management information systems. These technologies will also encompass processes for digitization, deployment and management of content, development and deployment of platforms and processes for capacity development, and creation of forums for interaction and exchange.

ICT and communications technology are the infrastructure and components which enable modern computing. ICT encompasses both the internet-enabled sphere as well as the mobile one powered by wireless networks. It also encompasses antiquated technologies, such as landline telephones, radio and television broadcast -- all of which are still widely used today alongside cutting-edge ICT pieces such as artificial intelligence and robotics. The term ICT is also used to refer to the convergence of audio-visual and telephone networks with computer networks through a single cabling or link system. ICT has no universal concept, as "the concepts, methods and applications involved in ICT are constantly evolving on an almost daily basis. The broadness of ICT encompasses any product that will store, retrieve, manipulate, transmit or receive information electronically in a digital form, e.g. personal computers, digital television, email, robots. Advancements, standards, specifications and subsequent adoptions have led to major growth in the extensibility, interoperability and scalability of e-learning technologies. E-learning is fast becoming a major form of learning. Computer multimedia offers ideal opportunities for creating and presenting visually enriched learning environments. The latest technologies connected with virtual reality will also play an important role in not too distance future. The rapid development of Information and communication technology, particularly the Internet, is one of the most fascinating phenomena characterizing the information age. ICT powers our access to information, enables new forms of communication, and serves many on-line services in the spheres of commerce, culture, entertainment and education.

Integrating ICT in teaching and learning is high on the educational reform agenda. ICT can moreover be seen as a way to merge into a globalizing world. It is assumed that ICT brings revolutionary change in teaching methodologies. The innovation lies not per se in the introduction and use of ICT, but in its role as a contributor

towards a student-centered form of teaching and learning. Enhancing and upgrading the quality of education and instruction is a vital concern. ICTs can improve the quality of education in a significant ways. ICTs are also tools which enable and bring about transformation. ICTs which can be in the form of videos, television and also computer multimedia software, that merges sound, transcripts and multicolored moving imagery, can be made use of so as to make available stimulating, thought provoking and reliable content that will keep the student interested in the learning process. The radio on the other hand through its interactive programs utilizes songs, sound effects, adaptations, satirical comedies and supplementary collections of performances so as to induce the students to listen and get drawn in to the training that is being provided. Academics have taken to the use of computer in teaching much more readily than they adopted earlier audio-visual media. This is because the strength of computers is their power to manipulate words and symbols - which is at the heart of the academic endeavor.

There is increasing trend to introduce e- learning or online learning both in courses taught on campus and in distance learning. Distance education and e-Learning is not necessarily the same thing and can have very different cost structures. Whether e-learning improves quality or reduce cost depends on the particular circumstances. ICTs in general and e- learning in particular have reduced the barriers to entry to the higher education business. ICT according to a number of commentators, enhance teaching, learning, and research, both from the constructivist and instructive theories of learning. Behind this increasing faith in the role of technology in higher education however, lies implied acceptance of technology by various commentators, either as neutral and autonomous, neutral and human controlled, autonomous and value laden, or human controlled and value laden.

### **REVIEW OF LITERATURE**

The integration of ICT in higher education is 'inevitable' (James & Hopkinson, 2009). ICT has changed the way businesses and industries are conducted and influenced the way people work, interact and function in society (Bhattacharya & Sharma, 2007; UNESCO, 2002). ICT has become common place at home, at work, and in educational institutions (Kirkup & Kirkwood, 2005). The use of ICT has increased exponentially (McGorry, 2002). Education drives the economic and social development of nation (Mehta & Kalra, 2006) and the importance of having competent human capital (Hassan, 2001; Purwadi, 2001). The use of ICT in higher education has resulted in a move from teacher-centred delivery and transmissive learning to student-centred learning. ICT functions as information sources and cognitive tools, supporting and enabling students to be responsible for their own learning (Jonassen & Reeves, 1996). Hattangdi and Ghosh (2005) used the terms informative, situating and constructive tools to further conceptualize the functions of ICT. Learning environments become inquiry-based and problem-centred within authentic settings. Lecturers are facilitators, coaches and mentors and ICTs support the learning environment (Oliver, 2000). The education and mostly higher education results in the adoption of technology at a higher rate. The internet helps in bringing out better outcomes in terms of quality in education ( Rye, 2008). According to Miller (2016), a lot of college students might not have the technical skills that are required to navigate through the online learning activities and mastering of instructional technology in an effortless manner is not guaranteed just because they are capable of handling the social media accounts that well.

### **OBJECTIVE AND METHODS**

The present paper purports to examine the dependency and use of internet and ICT among the students pursuing higher education in management and technical institutions. The paper is based on primary data collected through field survey in 20 Engineering and Management Institutes/ Colleges from Lucknow region of Uttar Pradesh. Overall 300 students pursuing higher education in Engineering, and Management were surveyed with the help of structured interview schedules.

### **DISCUSSION OF RESULTS**

ICTs are making dynamic changes in society. They are influencing all aspects of life. The influences are felt more and more at schools, colleges and universities because ICTs provide both students and teachers more opportunities in adapting learning and teaching. The field of education has been affected by ICTs, which have undoubtedly affected teaching, learning and research. ICTs have the potential to accelerate, enrich, and deepen skills, to motivate and engage students, to help relate school experience to work practices, create economic viability for tomorrow's workers, as well as strengthening teaching and helping schools change. In this part of the dissertation, an attempt has been made to examine the usage of ICT by students perusing higher education.

Majority of respondents revealed that they do not have access of information technologies or limited access to such technologies. The significant proportion of respondents who had wider access of information technologies

was reported to be in terms of white board, desk top computer, smart mobile phone, wireless internet access, broad band internet connection and pen drive. The respondents were asked that whether they have opened their account in social media. About 80 per cent respondents reported that they have opened their account in face book while about 2/3<sup>rd</sup> respondents further reported that they have account in whatsapp. About 1/4<sup>th</sup> respondents further reported that they have account in twitter and instagram .

The respondents were asked that whether they are using different types of information technology. A large proportion of respondents reported that they are not using information technologies such as use of computer to play games, use of web/internet for video calling, use of internet /web to play network games, use of social networking software on the web, use of web for keeping own blogs/account in social media, use of web for web conferencing and use of web for leisure activities. However, a large proportion of respondents reported that they are using various types of information technologies such as use of computers for preparing note, use of web to access literature and use of computers to develop digital photo/maps. The respondents were asked that which applications/programming they use in computer. Majority of respondents reported that they are using word processor, spread sheet and programming. About more than half of the respondents further reported that they are using web designing and image editor /photo shop. The respondents were asked that how often they use internet. Majority of the respondents revealed that they are regularly using internet. It was found more pronouncing in engineering institutions as compared to management institutions.

The respondents were asked that whether from where they get maximum access to internet. Slightly less than half of the respondents reported that they get maximum access to internet at home. However, about 48 per cent respondents revealed that they get maximum access to internet at college/institute. A significant proportion of respondents from management institutions reported that they get maximum access to internet at internet cafe. More than half of the respondents reported that most accessible place to get information through ICT for learning is computer lab. However, about 19 per cent respondents reported that most accessible place to get information through ICT for learning is class room. The adoption and use of ICTs in higher education have a positive impact on teaching, learning, and research. ICT can affect the delivery of education and enable wider access to the same. It can influence the way students are taught and how they learn. It would provide the rich environment and motivation for teaching learning process which seems to have a profound impact on the process of learning in education by offering new possibilities for learners and teachers. These possibilities can have an impact on student performance and achievement. The analysis also shows that students perusing higher education are highly influenced by ICTs and their access and usage of ICTs including social networking sites have potential to learn and gain skills as well as knowledge. The overall literature suggests that successful ICT integration in education.

## CONCLUSION

The increasing use of information and communication technologies has brought changes to teaching and learning at all levels of higher education systems to improve the quality. Traditional forms of teaching and learning are increasingly being converted to online and virtual teaching and learning. There are endless possibilities with the integration of ICT in the higher education system. The use of ICT in higher education not only improves classroom teaching learning process, but also provides the facility of e-learning. ICT has enhanced distance learning too. The outreach of teachers has increased while learners are able to access qualitative learning environment from anywhere and at anytime. Successful implementation of ICT to lead change is more about influencing and empowering teachers and supporting them in their engagement with students in learning rather than acquiring computer skills and obtaining software and equipment. The use of ICT can play a variety of roles in education by changing the teaching and learning process. However ICT integration is not easy task. There are significant challenges in integrating ICTs use in higher education system rising from environmental, cultural and educational faced by policy makers, educators, educational administrators and students in higher education. Thus there is a need of government support and the higher education institutions commitment to making the integration of ICT in education a successful process. The challenges to ICT usage among academic staff ranges from, lack of funds, less opportunity for training, lack of sponsorship by the college management, inability to acquire personal ICT facilities, inadequate ICT facilities at workplace, poor electricity supply, lack of ICT knowledge, insufficient time due to workload, lack of interest in learning, and lack of time for practice.

## REFERENCES

1. Bhattacharya, I. & Sharma, K. (2007). India in the knowledge economy - an electronic paradigm, *International Journal of Educational Management* Vol. 21 No. 6, pp. 543–568

2. Hassan, A. (2001). Impact of the economic crisis on higher education in Malaysia. In N.V. Varghese (Ed.), *Impact of the economic crisis on higher education in East Asia: Country experiences* (pp. 103-145). Paris: UNESCO.
3. Hattangdi, A. & Ghosh, A. (2008). Enhancing the quality and accessibility of higher education through the use of information and communication technology. Paper presented at the 11<sup>th</sup> Annual Convention of the Strategic Management Forum (SMF) (Kanpur, India, May 8-10, 2008
4. James, P. & Hopkinson, L. (2009). Sustainable ICT in further and higher education. UK: JISC. <http://www.jisc.ac.uk/media/documents/publications/rptgreenictv1.pdf> [viewed 28 Oct 2011
5. Jonassen, D. & Reeves, T. (1996). Learning with technology: Using computers as cognitive tools. In D. Jonassen (Ed.), *Handbook of research on educational communications and technology* (pp. 693-719). New York: Macmillan
6. Kirkup, G., & Kirkwood, A. (2005). Information and communications technologies (ICT) in higher education teaching—a tale of gradualism rather than revolution. *Learning, Media, & Technology*, 30(2), 185-199.
7. McGorry, S. Y. (2002). Online, but on target? Internet-based MBA courses: A case study. *The Internet and Higher Education*, 5(2), 167-175. [http://dx.doi.org/10.1016/S1096-7516\(02\)00089-1](http://dx.doi.org/10.1016/S1096-7516(02)00089-1)
8. Mehta, S. & Kalra, M. (2006). Information and communication technologies: A bridge for social equity and sustainable development in India. *The International Information and Library Review*, 38(3), 147-160. <http://dx.doi.org/10.1016/j.iilr.2006.06.008>
9. Miller, M. D. (2014). *Online Learning: Does It Work?* In *Minds Online: Teaching Effectively with Technology* (pp. 19-41). Harvard University Press
10. Oliver, R. (2000). Creating meaningful contexts for learning in web-based settings. In the *Proceedings of Open Learning 2000* (pp 53-62). Brisbane: Learning Network, Queensland. <http://elrond.scam.ecu.edu.au/oliver/2000/ol.pdf> [viewed 28 October 2011] Hong and Songan 1289
11. Purwadi, A. (2001). Impact of the economic crisis on Indonesia. In N. V. Verghese (Ed.), *Implications of the economic crisis on higher education in East Asia: Country experiences* (pp. 61-79). Paris: IIEP/UNESCO. [viewed 28 Oct 2011] <http://unesdoc.unesco.org/images/0012/001261/126192e.pdf>
12. Rye, S. A. (2008). Exploring the gap of the digital divide: Conditions of connectivity and higher education participation. *GeoJournal*, 71(2/3), 171-184
13. UNESCO (2002). *Open and Distance Learning Trends, Policy and Strategy Considerations*, UNESCO.

## Impact of Micro Finance on Enterprise Development in Uttar Pradesh

Sagar Shukla and Trupti Singh

School of Commerce and Management, MUIT, Lucknow, U.P, India

### ABSTRACT

Micro finance programs are expected to make significant contributions to eradicating poverty and empower poor in economic, social and political sectors. Increase in the income of rural poor families will have an impact on income, housing, consumption, health care, education of children, reducing burden of debt and so on. JLGs/SHGs are necessary to overcome exploitation, create confidence for the economic self-reliance of the rural poor. These groups enable them to come together for a common objective and gain strength from each other to deal with business development and income generation endeavors. Significantly, credit is a major factor in boosting economic development if it is effectively utilized. The government's recent initiatives to streamline credit operations and delivery system through micro finance movement and strengthening and expansion of financial institutions can definitely help in the revival of rural economy and empowerment of the rural poor. Against this backdrop, present paper examines the impact of micro finance provided through micro finance institutions on the enterprises development in Uttar Pradesh. The paper is based on mainly primary data collected through field survey.

### INTRODUCTION

Micro Finance has emerged as is a powerful instrument for poverty alleviation and empowering poor. The global nature of the Micro Finance movement is reflected in the growing number of organizations providing Micro finance to poor people. Micro Finance is being referred to as one of the cost effective and supplementary tools of rural credit delivery system which facilitates prompt and timely availability of institutional credit to poor in an effective and economical manner. One of the objectives of development planning is to reduce extant of poverty by providing employment opportunities and raising the income levels of the population. There has been remarkable progress in the outreach and expansion of MFIs in India. In this part of dissertation an attempt has been made to analyze the views of MFIs officials regarding micro finance activities. Entrepreneurship has been considered as the backbone of economic development. It has been well established that the level of economic growth of a region, to a large extent, depends on the level of entrepreneurial activities in the region. Microfinance has positive impact on enterprise development and most of the MFIs are providing technical and business development services besides financial services to the poor and small entrepreneurs. Against this backdrop, present study aims at examining the impact of microfinance on rural enterprises development.

The SHGs based micro financing programme has wider coverage to more than 10 million groups while a large amount of loan was disbursed for livelihood generating activities. The poverty alleviation programmes such as NRLM and NULM account for majority of SHGs (NABARD, 2019). However, Southern states have major share while Central Region (10.6 per cent) and Northern Region (5.5 per cent) recorded lower shares. Micro Finance Institutions presently are in operation in 29 States and 4 Union Territories with the outreach of 563 districts. Twenty one MFIs have wide outreach and are functional in more than five states while four MFIs are operating in more than fifteen states. However, 57 MFIs are functional in two to five states while 90 MFIs are confined to only one state. The client outreach of MFIs had grown significantly during the period of 2005 to 2011 and achieved a level of 317 lakh clients. Majority of these clients are being served by NBFCs (NBFC/NBFC-MFIs). Number of functional MFIs during 2017 was reported large in Maharashtra followed by Madhya Pradesh, Bihar, Chhattisgarh and Uttar Pradesh. However, number of branches was reported large in Uttar Pradesh followed by Karnataka, Madhya Pradesh, Tamil Nadu, Bihar and West Bengal. Number of clients was reported high in Karnataka followed by Uttar Pradesh, Bihar, Odisha and Tamil Nadu. Gross loan portfolio was recorded high in Karnataka followed by Uttar Pradesh, Maharashtra, Bihar, Tamil Nadu and West Bengal (Mishra and Tankha, 2018).

MFIs can either grow by expanding their branch network or by adding more clients to the existing branch. While the first approach typically leads to greater breadth in operations, the second approach leads to depth within the existing area of operation. During the year 2017–18, an analysis of the operations of the top 10 NBFC-MFIs shows that a mixed approach was the trend. Except in the case of Spandana, Muthoot and Asirvad, growth in the number of clients is either similar to growth in branches or slightly less. The overall data for 47 NBFC-MFIs also confirms this trend, as the sector average was 25 per cent annual growth in both the number of branches and clients. A logical corollary of this aspect is that the existing operational areas of MFIs are

saturated, necessitating a move to new geographies. As the number of districts with NBFC-MFI presence did not see a corresponding increase during the year, it can be inferred that most of the new branches are within existing districts. It is a positive development because in previous years the focus was more on depth that is, adding more branches.

The number of micro finance institutions functional in the state was reported high in Maharashtra followed by West Bengal, Tamil Nadu, Madhya Pradesh, Bihar and Uttar Pradesh. Number of districts of the state which were covered by MFIs operation was reported high in Uttar Pradesh followed by Madhya Pradesh, Maharashtra, Tamil Nadu, Bihar, Karnataka and Odisha. Similarly, there were 10233 branches of MFIs and a large number of MFI branches were found located in Karnataka, Tamil Nadu, West Bengal, Uttar Pradesh, Madhya Pradesh and Maharashtra. The top five states viz., Karnataka, Tamil Nadu, Uttar Pradesh, Odisha and Bihar account for 60 per cent of total client outreach in India.

Most of MFIs provide financial services through group based financial model such as JLGs/ SHGs . These institutions lend through the concept of Joint Liability Group (JLG). A JLG is an informal group which comprising of 5 to 10 individual members who join together for receiving credit either individually or through the group based mechanism. Out of cumulative number of JLGs promoted in India as on March 31st, 2019, southern states accounted share of 30.97 percent while eastern states constituted more than one third share. The share of northern states was recorded 13.24 percent while least share went to north eastern states. Out of the total loan disbursed as on March 31st , 2019, about two fifth share accounted for southern states while about 27 percent share was reported for eastern states ( NABARD, 2019) .

Micro-enterprise development and microfinance has been widely adopted as anti-poverty strategies in most of the countries. Micro enterprises have been accepted as an engine of economic growth and development. Women owned businesses are one of the fastest growing sectors of micro-enterprises. Micro-enterprise support programs aims to help people with modest means to start, strengthen and expand very small businesses. Micro-enterprises encourage self-employment to a large amount. Micro enterprises have been accepted as the engine of economic growth and for promoting equitable development. Women owned businesses are one of the fastest growing sectors of micro-enterprises. Economic growth, stability and equity can be achieved significantly through micro-enterprises. Micro-enterprises encourage self-employment to a large extent. Microenterprise development helps micro-entrepreneurs combine their knowledge and determination with microfinance services to attain standard of living and generate income through business. Microenterprises are small or petty business ventures, usually conducted by the poor. They are limited to an income generation activity but are included in the concept of business activity in which profit is a major motive of the owner/ entrepreneur. Microenterprises are mostly the outcome of the efforts at promoting self employment. Microenterprises are generally known as poor people's businesses. They are small in size and scale and locally served. Microenterprise is seen as one of the alternatives for the livelihood of the poor. Entrepreneurial spirit and efficient role of the supporting systems for the expressions seem to be important factors in development of microenterprise.

Microenterprises also usually operate in the informal sector and could a trading (street vendors, food stalls), beauty-parlors, transport operators etc. are service sector set up or even a small manufacturing unit( machine shops or assembly units etc.). Microenterprises are set up a little investment in fixed assets and inventory. They operate mostly on cash and carry terms. The enterprises sales may not be distinguished from any other kind of income of the individual or household earning. These enterprises may be quite unstable and footloose. If better opportunity arises or cost cannot be recovered, the entrepreneurs may move on or shift to other activity. Microenterprise has been found in literature related to non-farm sector, employment, Self Employment, Microfinance, Self Help Groups etc. It is a strategy for creation of jobs, self employment promotion in non-farm sector, rural industrialization and economic development with special reference to the poor, marginalized and excluded population of the society.

## REVIEW OF LITERATURE

Alaoui and Tkiouat (2019) opined that microfinance provide traditional banking services with the aim of reducing their poverty. Various strategies have been utilized to demonstrate consumer loyalty in micro-finance. Bhatia and Singh (2019) revealed that females residing in urban slums area didn't need access to budgetary foundations yet encountered (a) fiscal perils, for instance, variable income, non-legitimately binding casual occupations, (b) cash-related threats, for instance, reliance on the money economy, casual credit, and (c) social risks, for instance, social cracks. Joseph and Kibera (2019) in their study highlighted the determining factors that influence organizational culture on the performance of micro-finance institutions. Ghosh et.al. (2018) highlighted the issue of interest rate sensitivity in micro finance sector. Jose (2017) finds out that the basic



objective for a microfinance institution to sustain the borrower, but that is not satisfactory achievable due to diversification of funds. Gullifer and Tirado (2017) in their paper highlighted that micro finance has significant impact on economy. Mishra and Haque (2016) are of the view that economic evolution had a major impact on economic development in all major areas. Sa-Dhan (2016) analyzes that the existence of MFIs has spread in areas across the countries, although they are still limited in some states. Seenivasan (2015) points out why the MFIs fail and the poverty alleviation targets are forgotten. Brown et.al. (2012) have examined the geographical proximity of micro finance institutions towards financial inclusion. Firdausi (2013) measures the relative efficiency of microfinance institutions in India, Bangladesh, and China. Goel & Rishi (2012) highlighted that measures and norms that can develop entrepreneurship skills among the poorest people. The review of pertinent literature simply demonstrates that there is paucity of literature, research findings and empirical data pertaining to impact of micro finance extended by micro finance institutions to the rural borrowers for enterprises development.

### **OBJECTIVES AND METHODS**

Present paper is based on a major research study. The main objectives of the paper are as follows:

- To examine the socio- economic profile of borrowers and examine the issues of micro financing ;
- To assess the impact of micro-finance and enterprises development;
- To suggest the policy measures for empowerment of rural entrepreneurs, development of SHGs based micro financing and micro enterprise development.

The present study is analytical in nature with major focus on primary data gathered through the survey. The study is confined to Central region of the state of Uttar Pradesh. We have selected Lucknow , Raibareli, Lakhimpur Kheri, Sitapur and Unnao in Lucknow region of the state. Overall, 300 rural entrepreneurs/ borrowers supported by micro finance institutions were randomly selected for interview with the help of structured interview schedule .

### **DISCUSSION OF RESULTS**

Majority of borrowers were from the middle age group while most of the borrowers were females. About 18 per cent respondents were Muslims. However, majority of respondents were from reserved category such as OBCs, Scheduled Caste and Minority communities. Most of the respondents were found married. However, educational backgrounds of the respondents were found to be poor. Their main occupation was reported to be self employment in agriculture and non-agriculture sector. However, about 22 per cent respondents were casual labour.

Most of the respondents have their bank account and are saving money. However, average monthly saving of family was reported to be low. Majority of respondents revealed that they have never use ATM card. Less than half of the respondents reported that they have life insurance policy in their name. About 67 per cent respondents reported that they are from joint families and their main family occupation is petty business and labour. Their annual family income was reported above Rs. 90,000 for majority of the cases. Most of the respondents were found living in pucca houses with availability of drinking water, electricity, cooking gas and toilet facility.

Most of the borrowers were members of JLGs. Majority of the respondents revealed that they joint JLGs/SHGs before 5 years. About 73 percent borrowers reported that they get information of micro finance through JLGs. They further reported that they were motivated to join micro finance institutions mainly by JLGs, family members, media and friends and relatives. The main factors for joining micro finance institutions were reported to be motivation by JLGs, hassle free process to sanction loan, collateral free loan, low rate of interest on loan, advice of bank and financial incentives. Most of respondents reported that they received loan as member of JLGs. About 51 per cent respondents received one time loan while about 37 percent respondents reported that they have received loan twice.

The main purpose of using micro finance was reported to be income generating and business development. The average amount of loan was reported to be low as more than 2/3<sup>rd</sup> borrowers received loan in between Rs. 20,000 to 30,000. More than 1/4<sup>th</sup> respondents revealed that they also approached to take loan from other agencies as the loan amount was not adequate. More than half of the respondents reported that they are making their regular payment of installments of loan during group meetings while about 47 per cent respondents said that MFIs representatives are collecting installments of loan. Most of the respondents reported that they have paid their loan amount. Majority of respondents were found satisfied with the services of micro financial

institutions. These services include service charges, rate of interest. Interest based loan system, loan repayment installment, loan repayment cycle, financial service advice and micro finance products. They were found in favour of that MFIs are engaged in poverty reduction, community development, social development and enterprise development.

There has been positive impact of MFIs on savings, income, poverty reduction, participation in decision making, development programmes, empowerment and self-esteem. There has been significant social impact of JLGs /SHGs while access and utilization of micro finance has significant social and economic impact on borrowers. The standardized structural model estimates coefficients of the latent and observed exogenous variables to the latent endogenous variable indicated that religion of respondents, marital status, types of family, and family occupations positive and significantly shown impact on microfinance, while, the gender of respondents found negative and significantly shown impact on microfinance. The result revealed that the impact on microfinance is negatively affected by the gender of respondents, while positively by the religion of respondents, marital status, types of family, and family occupation. The chi-square test has been applied to find out the relation between the gender, age, education, social class, religion, type of family, occupation, family occupation, income of family etc, of the respondents and the impact of microfinance. The value of chi-square has been found significant at 1 percent level of significance.. This is showing that these variables are highly related to the impact on microfinance

Most of the respondents reported that micro enterprises are situated in rural areas. The enterprises were mainly in varied nature of business such as handicraft, handloom, garment making, chikan zardouzi, manufacturing of bag and office file folders, trade, services and animal husbandry. Majority of the respondents reported that established their business enterprises before 3 years. About half of the respondents revealed that more than 8 members joined their business. The persons employed in business enterprises were reported to be mainly group members and family members. About 3/4<sup>th</sup> respondents revealed that their members had experience in similar entrepreneurial activity prior to setting up business.

Decision of JLG/SHG, easily availability of raw materials, previous experience, market potential and home based work were some of the main factors which influence in selection of enterprise activities. However, about 2/3<sup>rd</sup> respondents reported that they were motivated by JLG members. About 7 per cent respondents were self motivated to start their enterprises. Most of the respondents reported that they are getting raw materials from local areas. They availed loan for business development. However, average amount of loan for business development was reported to be low (less than Rs. 55,000) for most of the cases. The main purpose of loan was reported to be business development. Most of the respondents further reported that they have availed CCL facility. Most of the respondents said that they availed adequate amount of loan.

The entrepreneurs reported that they are using multiple marketing channels for marketing of their finished products and services. These include both direct and indirect channels of marketing. A significant proportion of respondents reported that they are exploiting the market potential in local haats, weekly haats and fairs. About half of the respondents revealed that the quality of their products and services is below average while about 20 percent respondents said that quality of products and services are average. About 61 per cent respondents further revealed that they are facing difficulty in marketing of goods and products.

Most of the respondents revealed that they have institutional linkages for capacity building, availability of raw materials, market and financial support. Most of respondents revealed that JLGs are also monitoring their enterprises. About 60 per cent entrepreneurs were in favour of diversifying their business in near future while most of entrepreneurs are in favour of enlarging their business in near future. However, they require finance, assured market, technology, raw materials and technical know-how.

There has been positive impact of business enterprises on social and economic status of entrepreneurs. The impact has been mainly measured in terms of social mobility, recognition in family and community, access to health services, credit facility, income generation, asset building, participation in decision making, etc. The main problems in management of enterprises were reported to be availability of credit, adequacy of loan, timely availability of finance, collateral free loan, training, entrepreneurship development, availability of raw materials, and maintenance of quality, branding and marketing. The value of chi-square has been found significant at 1 percent level of significance with relation to gender, age, education, religion, social class, marital status, family type, family income and occupation to the nature of enterprises has been found significant.

## SUGGESTIONS

- Entrepreneurial and management skills such as risk bearing, enterprise planning, product innovation, need perseverance, financial resource mobilization, production, marketing demand forecasting, cost control, human resources related aspects may be undertaken in the course curriculum of training programmes for entrepreneurs .
- It is the need of hour that government programmes should be streamlined in such a way so that convergence of schemes may be ensured for skill training, extension support, credit and other enterprise related services.
- Strengthening the infrastructure to facilitate the all round development of the small and micro business is the need of hour. This requires development of adequate infrastructure such as roads, connectivity power, transportation etc. Giving piloting role in establishing infrastructure in the state may encourage private sector.
- The enterprises based on local requirements should strive to offer innovative products or services. Efforts should be made for tie-ups with big firms for marketing networks.
- Government should set up common facility centre, micro business centre, advisory and consultancy services, etc. in the industrial and business clusters so that the interested women may be provided skill training, entrepreneurship development and proper guidance for starting up business enterprises.
- Value chain for raw material, packaging and marketing would help in micro-enterprise development and should be established through the assistance from microfinance innovation fund. Common service centre for packaging and use of latest technology for packaging will help in marketing of the produce.

## REFERENCES

1. Alaoui, L., Y., & Tkouat, M. (2018). Risks assessment in Moroccan microfinance sector: An interval-valued intuitionist fuzzy set approach, *International Journal of Engineering Business Management*.
2. Bhatia, S., & Singh, S. (2019). Empowering Women Through Financial Inclusion: A Study of Urban Slum. *Vikalpa*, 44(4), 182–197.
3. Brown, M., Guin, B., & Kirschenmann, K. (2012). Microfinance Commercialization and Mission Drift. *Die Unternehmung*, 66(4), 340-357.
4. Firdousi, F. (2013). Performance of microfinance institutions in Asia. DEA based efficiency analysis. In *International Conference on the Modern Development of the Humanities and Social Sciences*, Atlantis Press, Paris (pp. 91-94).
5. Ghosh, R., Latha, K., & Gupta, S. (2018). Interest Rate Sensitivity of Non-banking Financial Sector in India. *Vikalpa*, 43(3), 152–170.
6. Goel, G., & Rishi, M. (2012). Promoting entrepreneurship to alleviate poverty in India: An overview of government schemes, private-sector programs, and initiatives in the citizens' sector. *Thunderbird Int'l Bus Rev*, 54, 45–57.
7. Gullifer, L., & Tirado, I.(2017). Financing micro-businesses and the UNCITRAL Model Law on Secured Transactions. *Uniform Law Review*, 22(4), 642–662.
8. Jose, S., & Chacko, J. (2017). Sustainable development of microfinance customers: An empirical investigation based on India. *Journal of Enterprise Information Management*, 30(1), 49-64.
9. Joseph, O., & Kibera, F. (2019). Organizational Culture and Performance: Evidence From Microfinance Institutions in Kenya. *SAGE Open*.
10. Mishra, A., & Haque, Z. (2016). Technological Innovations in Financial Inclusion in India. *Journal of Asian Business Management*, 8(2).
11. Mishra, Alok and Ajai Tankha ( 2018) *Inclusive Finance India* , Access – Assist , New Delhi
12. NABARD ( 2019) *Micro Finance in India* , NABARD, 2019 , Mumbai
13. Sa- Dhan (2016) *The Bharat Micro Finance Report*, Sa –Dhan, New Delhi
14. Srinivasan, N (2012), *Microfinance India: State of the Sector Report 2011*, SAGE Publications, New Delhi.

## Kinetics and Mechanism of the Oxidation of Menthol by Benzimidazolium Dichromate

Amol P. Kharche<sup>\*1</sup>, Rajendra T. Jagtap<sup>2</sup>, Sandip K. Jagdale<sup>3</sup>, Hiral C. Surani<sup>4</sup> and Hariram R. Yadav<sup>5</sup>

<sup>1,2,3</sup>Pimpri Chinchwad College of Engineering (An Autonomous Institute affiliated to SPPU, Pune), Sector-26, Pradhikaran, Nigdi, Pune - 411 044, India

<sup>4</sup>Department of Pharmaceutical Chemistry, Bombay College of Pharmacy (Autonomous), Mumbai, India

<sup>5</sup>Department of Quality Assurance, Dr. L. H. Hiranandani College of Pharmacy, University of Mumbai, India

### ABSTRACT

The kinetics of oxidation of secondary cyclic alcohol like menthol by Benzimidazolium Dichromate (BIDC) as an oxidant in acidic nonaqueous medium leads to the formation of cyclic ketone like menthone. Cr (VI) compound acts as two electron oxidizing agent in this oxidation reaction. The reaction is found to be first order with respect to each [oxidant], [Alcohol] and [TsOH]. The reaction mixture failed to induce the polymerization of added acrylonitrile. The reaction is catalysed by hydrogen ions. The oxidation reaction of menthol was studied in ten different organic solvents. The solvent effect was studied by using Kamlet's and Swain's multiparametric equations. Solvent effect shows the importance of the cation-solvating power of the solvent. The reaction has been carried out at four different temperature and the activation parameters were calculated. Negative  $\Delta S^\ddagger$  values indicate a structured transition state. A suitable reaction mechanism has been suggested.

Keywords: Kinetics, Mechanism, Oxidation, Menthol, Dichromate.

### INTRODUCTION

Selective oxidation of various alcohols to their corresponding aldehydes and ketones is an important reaction in organic chemistry which has received the most attention over many years. Chromium (VI) oxidants are the most efficient and versatile for performing these reactions. So numbers of different chromium (VI) derivatives have been used as an oxidant<sup>1-5</sup>. One of such compounds is Benzimidazolium Dichromate (BIDC) reported by Q. H. Meng et al<sup>6</sup>. The literature survey on the kinetics of oxidation of cyclic alcohols with different oxidant reveals that the reactivity of alcohols varies with the type of oxidant used<sup>7-9</sup>.

As there is no report available on the oxidation of menthol by BIDC. We report here the kinetics of oxidation of menthol by BIDC in dimethyl sulphoxide (DMSO) as solvent. A suitable mechanism has also been proposed.

### EXPERIMENTAL

#### Materials

BIDC was prepared by the reported method<sup>6</sup> and its purity checked by an iodometric method. Menthol (Loba Chemie) was used as supplied. Due to non-aqueous nature of the solvent, p-toluene sulphonic acid (TsOH) was used as a source of hydrogen ions. Purification of other solvents was carried out by the usual methods of purification<sup>10</sup>.

#### Product Analysis

Product analysis was carried out under kinetic conditions. In a typical experiment, Menthol (0.05 mol) and BIDC (0.005 mol) were made up to 50 cm<sup>3</sup> in DMSO and kept for 24 h to ensure completion of the reaction. The oxidation state of chromium in completely reduced reaction mixtures was determined iodometrically and it was found to be +4.

At the end of the reaction, ether solvent was added to the reaction mixture; the organic layer was washed with water, dried over anhydrous Na<sub>2</sub>SO<sub>4</sub>, and then concentrated. The product was obtained as oily liquid (yield: ~85%), having a boiling point of 207°C characteristic of menthone. The 2,4-dinitrophenylhydrazone (DNP) derivative of menthone was prepared, and recrystallized from ethanol to give orange crystals (M.P. = 145°C). The melting point is found to be identical with literature value.

#### Kinetic Measurements

The pseudo-first order conditions were attained by maintaining a large excess (×10 or more) of the menthol over BIDC. The solvent used was DMSO. The reactions were followed, at constant temperatures (± 0.1 K), by monitoring the decrease in [BIDC] spectrophotometrically at 365 nm. No other reactant or product has any significant absorption at this wavelength. The pseudo-first order rate constant,  $k_{\text{obs}}$ , was evaluated from the linear ( $r^2 = 0.990 - 0.999$ ) plots of  $\log [\text{BIDC}]$  against time for up to 80% reaction. Duplicate kinetic runs showed that, the rate constants were reproducible to within ± 3%.

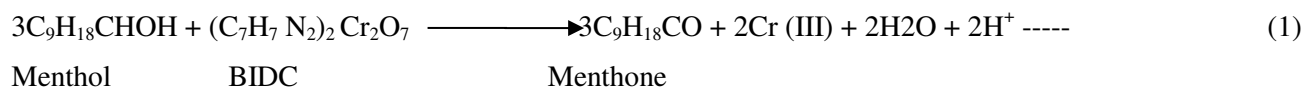
The second order rate constant,  $k_2$ , was evaluated from the relation shown by given formula like  $k_2 = k_{\text{obs}}/[\text{Menthol}]$ . Simple and multivariate linear regression analyses were carried out by the least-squares method on a personal computer by using software RegressIt.

## RESULTS AND DISCUSSION

The kinetics of oxidation of menthol by B IDC was studied at different initial concentrations of menthol in non-aqueous medium and the observed results are discussed below.

### Stoichiometry

The oxidation of menthol by B IDC resulted in the formation of the menthone. The overall reaction may therefore, be represented as equation (1). The stoichiometry of the reaction was determined by carrying out several sets of experiments with varying amount of [B IDC] over excess [Menthol]. The estimation of unreacted B IDC showed that three moles of alcohol reacts with one mole of B IDC.



### Test for Free Radicals

The oxidation of menthol by B IDC, in an inert atmosphere of nitrogen, failed to induce polymerization of acrylonitrile. In blank experiments, in absence of substrate, there was no noticeable consumption of B IDC. It shows that, the addition of acrylonitrile has no effect on the reaction mixture indicating the absence of free radical mechanism. This indicates a one electron oxidation giving rise to free radicals is unlikely in the present reaction.

Further confirmation for the absence of free radicals during the course of the reaction was checked by adding 0.05 mol dm<sup>-3</sup> of 2, 6-di-t-butyl-4-methylphenol (butylated hydroxyl toluene or BHT) in reaction mixture. It was found that, BHT was recovered unchanged, almost quantitatively.

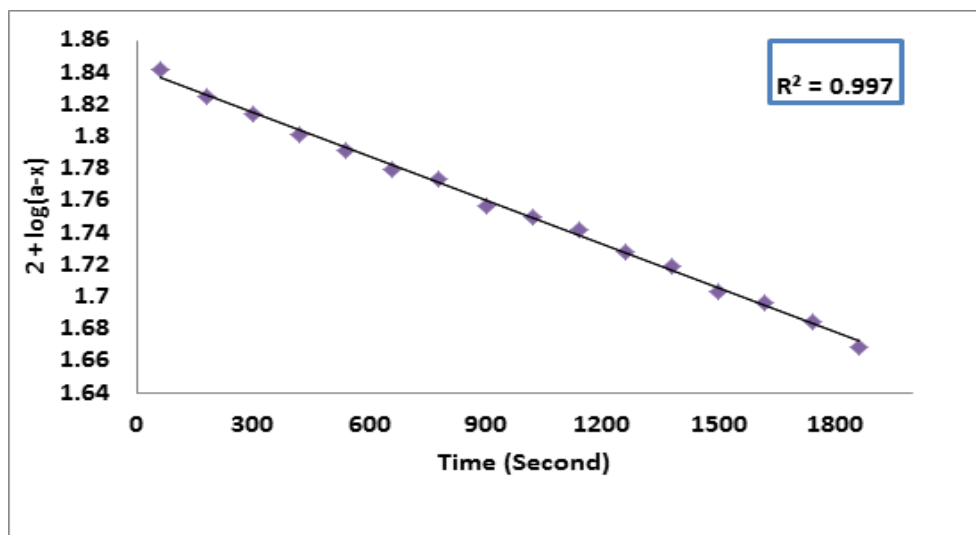
### Effect of Oxidant Concentration

At constant [Substrate] and [TsOH], the increase in [B IDC] did not affect the rate of reaction.

The reactions were found to be first order with respect to B IDC. The **Figure-1** and **Table-1** shows a typical kinetic run. In individual kinetic runs, plots of log [B IDC] versus time were linear ( $r^2 > 0.995$ ). Further, it was found that the observed rate constant,  $k_{\text{obs}}$ , does not depend on the initial concentration of B IDC.

### Effect of Substrate Concentration

At constant [B IDC] and [TsOH], the reaction rate increases linearly with increase in the [Menthol], indicating first order dependence with substrate. **Figure-2** shows the plot of log  $k_{\text{obs}}$  versus log [Menthol] gave a straight line with unit slope indicating the first order dependence on substrate. The second order rate constant  $k_2$  is constant suggesting the first order dependence on [Menthol]. A double reciprocal plot of  $1/k_{\text{obs}}$  against  $1/[\text{Menthol}]$  is linear and passing through the origin ( $r^2 > 0.995$ ) as shown in **Figure-3**. It shows first order behavior of this oxidation process and further suggested that no stable complex between B IDC (oxidant) and substrate is formed.



**Figure 1:** Oxidation of Menthol by B IDC: A typical Kinetic Run.

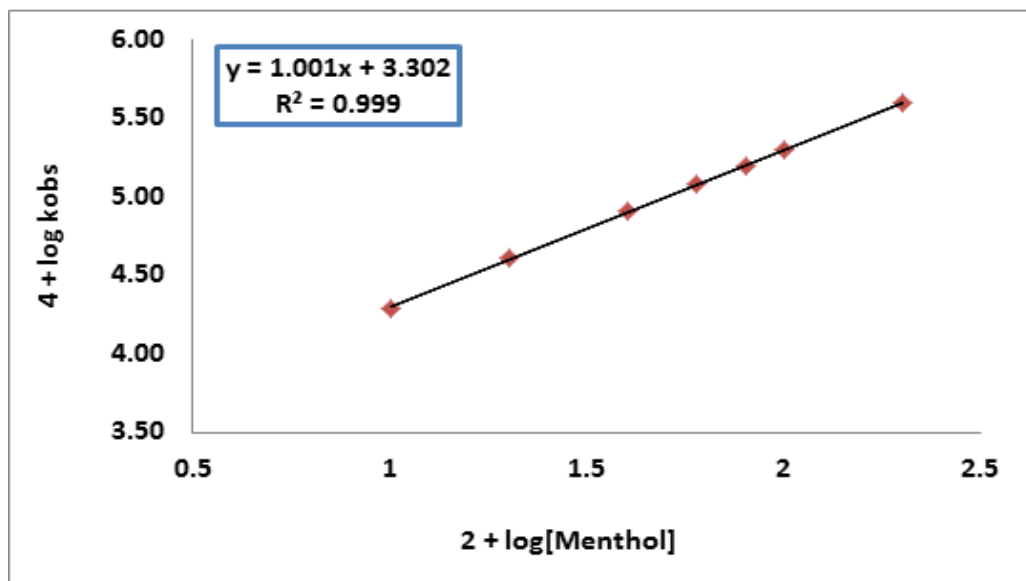


Figure 2: The plot of  $\log k_{\text{obs}}$  versus  $\log [\text{Menthol}]$

Table-1: Rate constants for the oxidation of menthol by BIDC at 300K.

$10^3[\text{BIDC}]$ ----- (mol dm <sup>-3</sup> )	$[\text{Menthol}]$ ----- (mol dm <sup>-3</sup> )	$[\text{TsOH}]$ ----- (mol dm <sup>-3</sup> )	$10^4 k_{\text{obs}}$ ----- s <sup>-1</sup>
1.0	0.10	0.10	1.98
1.0	0.20	0.10	4.11
1.0	0.40	0.10	8.06
1.0	0.60	0.10	12.3
1.0	0.80	0.10	15.9
1.0	1.00	0.10	20.2
1.0	2.00	0.10	40.3
2.0	0.10	0.10	1.97
4.0	0.10	0.10	1.95
6.0	0.10	0.10	1.98
8.0	0.10	0.10	1.97
1.0	0.10	0.10	1.99*

\* Contained 0.001M Acrylonitrile

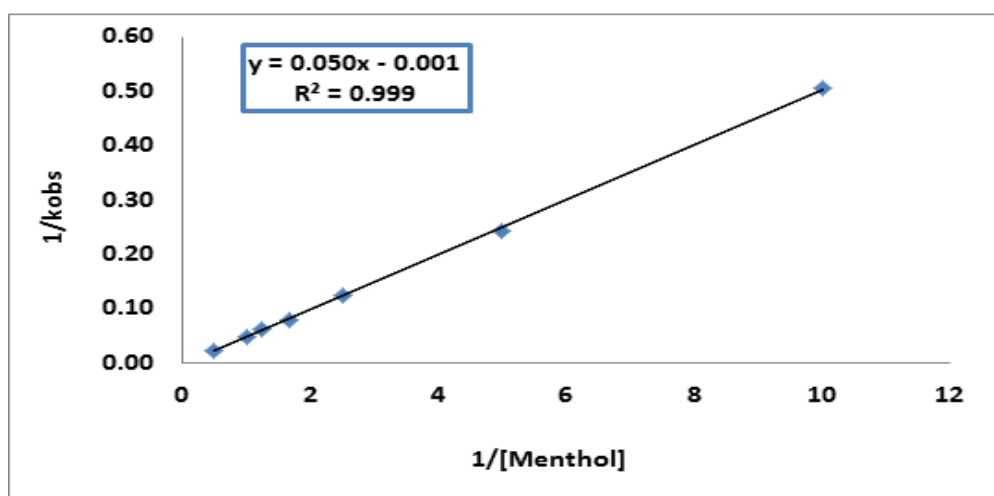


Figure 3: A double reciprocal plot of  $1/k_{\text{obs}}$  against  $1/[\text{Menthol}]$

#### Effect of TsOH Concentration

The reaction is catalyzed by hydrogen ion; the acid catalysis may well be attributed to the protonated ion of BIDC to give a stronger oxidant and electrophile. The rate of reaction increases with increase in TsOH concentration as shown in Table 2. The plot of  $\log k_{\text{obs}}$  versus  $\log [\text{H}^+]$  are also straight line with nearly unit slope, indicating a first order dependence on  $[\text{H}^+]$  is shown in Figure 4.

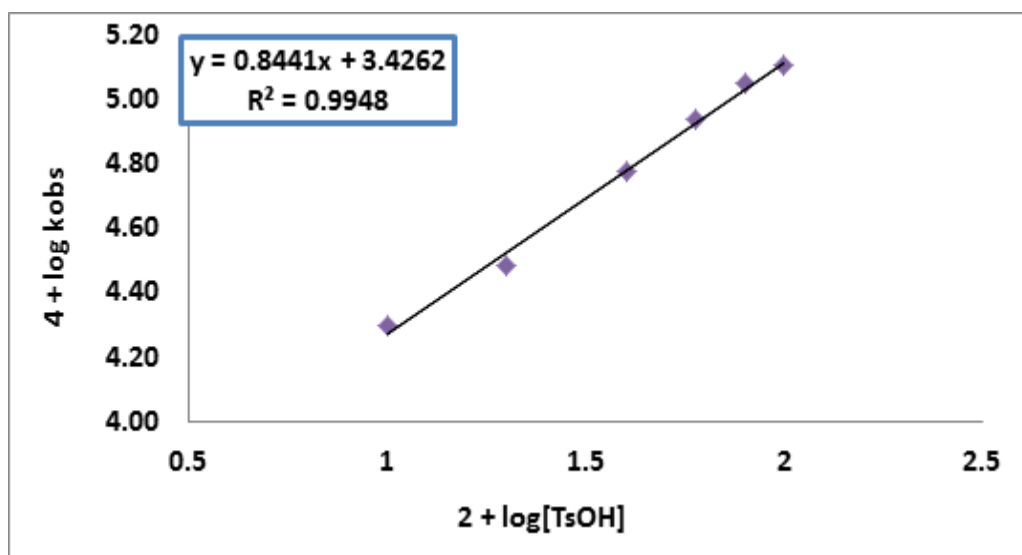


Figure 4: The plot of  $\log k_{\text{obs}}$  versus  $\log [H^+]$

#### Rate Laws

$$\text{Rate} = k' [\text{Oxidant}] [\text{Substrate}] [H^+]$$

$$\text{Rate} = k_{\text{obs}} [\text{Oxidant}]$$

$$k_{\text{obs}} = k' / [\text{Substrate}] [H^+]$$

#### Effect of Temperature

The rate of oxidation of menthol by BIDC was obtained at different temperatures between 300K and 315K. The values of rate constant ( $k_2$ ) are recorded in **Table 3**. The activation parameters for the oxidation of menthol by BIDC were calculated from the values of  $k_2$  at different temperatures (**Table 3**).

The  $\log k_2$  values at different temperatures is linearly related to the inverse of the absolute temperatures (**Figure 5**). It proves that, the Arrhenius equation is valid for this reaction.

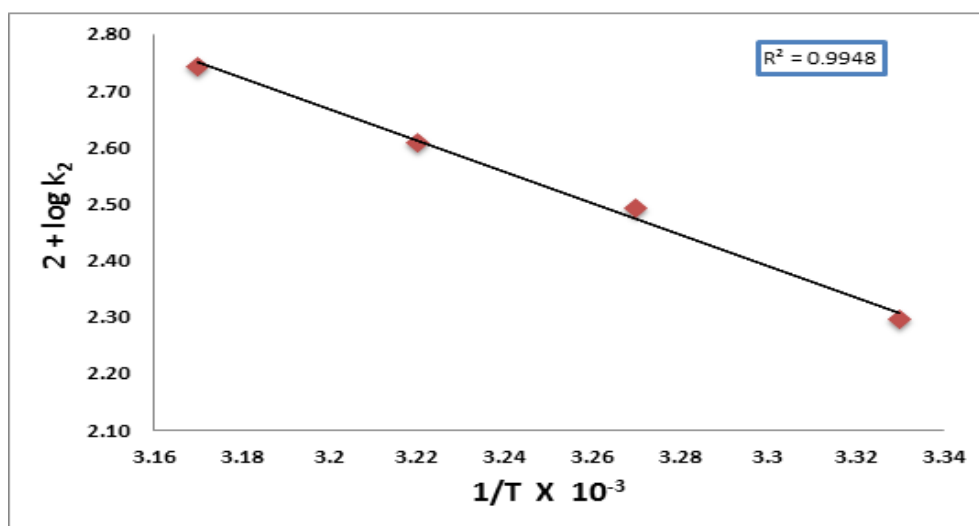


Figure 5: Effect of temperature on rate (Arrhenius plot)

Table-2: Dependence of the reaction rate on hydrogen-ion concentration.

[BIDC] = 0.001 mol dm <sup>-3</sup> ;	[Menthol] = 0.1 mol dm <sup>-3</sup> ;			Temp. = 300K		
[TsOH] / mol dm <sup>-3</sup>	0.10	0.20	0.40	0.60	0.80	1.00
10 <sup>4</sup> k <sub>obs</sub> /s <sup>-1</sup>	1.98	3.05	5.93	8.64	11.2	12.8

Table-3: Rate constants and activation parameters for the oxidation of Menthol by BIDC.

10 <sup>4</sup> k <sub>2</sub> / (dm <sup>3</sup> mol <sup>-1</sup> s <sup>-1</sup> )				ΔH <sup>#</sup>	ΔS <sup>#</sup>	ΔG <sup>#</sup>	E <sub>a</sub>
300 K	305 K	310 K	315 K	(KJmol <sup>-1</sup> )	(Jmol <sup>-1</sup> K <sup>-1</sup> )	(KJmol <sup>-1</sup> )	(KJmol <sup>-1</sup> )
1.98	3.12	4.08	5.56	50.40	-147	95.77	52.96

### Effect of Solvent

Solvent plays important role during chemical reactions. The effect of solvent on the rate of any reaction can be described in terms of solvation which is a process of stabilization. The rates of oxidation of menthol were obtained in ten different organic solvents. The selection of solvent was limited due to solubility of BIDC and its reaction with the solvent like alcohols. There was no reaction with the solvents selected for study. Similar type of kinetics is observed in all selected solvents. The values of second order rate constants,  $k_2$  are presented in Table 4.

**Table-4:** Effect of solvents on the oxidation of Menthol by BIDC at 300K.

Solvents	$10^5 k_2 / (\text{dm}^3 \text{mol}^{-1} \text{s}^{-1})$	Solvents	$10^5 k_2 / (\text{dm}^3 \text{mol}^{-1} \text{s}^{-1})$
Cyclohexane	0.23	Acetic Acid	1.92
Benzene	2.11	Dichloromethane	6.05
Toluene	1.86	Acetophenone	7.21
Chloroform	6.53	Acetone	6.55
Ethyl Acetate	2.43	DMSO	19.8

The rate constants,  $k_2$ , in ten different solvents were correlated in terms of the linear solvation energy relationship (Equation 2) presented by Kamlet *et al*<sup>11</sup>.

$$\log k_2 = A_0 + p\pi^* + b\beta + a\alpha \quad \dots\dots\dots (2)$$

The solvatochromic parameters in above equation (2) like  $\pi^*$ ,  $\beta$  and  $\alpha$  are characteristic of different solvents.

$\pi^*$  indicates the solvent polarity which is a measure of the ability of solvent to stabilize a dipole or charge due to its dielectric effect.  $\beta$  Indicates the hydrogen bond acceptor basicity which is the ability of solvent to donate an electron pair or to accept a proton in a hydrogen bond between solute to solvent.  $\alpha$  shows the hydrogen bond donor acidity which is the ability of a solvent to donate a proton, or accept an electron pair in a hydrogen bond between solute to solvent.

$A_0$  is the intercept term. It may be state here that, out of the ten solvents shown in **table-4**, six solvents has a value of zero for  $\alpha$ . In our correlation analyses, we have used the coefficient of determination ( $R^2$  or  $r^2$ ), Standard deviation (SD) and Exner's statistical parameter<sup>12</sup>,  $\psi$  as the measures of the goodness of fit. We analyses the results of correlation in terms of equation (2), a biparametric equation involving a solvatochromic parameters  $\pi^*$  and  $\beta$ , and separately with  $\pi^*$  and  $\beta$  are given below by Equations (3) - (6)

$$\log k_2 = -5.60 + 1.74 (\pm 0.36) \pi^* + 0.118 (\pm 0.40) \beta - 0.054 (\pm 0.25) \alpha \quad \dots\dots\dots (3)$$

$$R^2 = 0.885; \quad SD = 0.21; \quad n = 10; \quad \psi = 0.34$$

$$\log k_2 = -5.60 + 1.70 (\pm 0.30) \pi^* + 0.17 (\pm 0.29) \beta \quad \dots\dots\dots (4)$$

$$R^2 = 0.884; \quad SD = 0.20; \quad n = 10; \quad \psi = 0.34$$

$$\log k_2 = -5.62 + 1.80 (\pm 0.23) \pi^* \quad \dots\dots\dots (5)$$

$$r^2 = 0.879; \quad SD = 0.19; \quad n = 10; \quad \psi = 0.35$$

$$\log k_2 = -4.75 + 1.13 (\pm 0.53) \beta \quad \dots\dots\dots (6)$$

$$r^2 = 0.361; \quad SD = 0.445; \quad n = 10; \quad \psi = 0.89$$

Here,  $n$  represents the number of data points considered in analysis. When kinetic data is correlated with solvatochromic parameters  $\pi^*$ ,  $\beta$  and  $\alpha$  by using Kamlet's<sup>11</sup> triparametric equation suggests ca. 89 % of the effect of solvent on the oxidation. However, according to Exner's criterion<sup>12</sup> the correlation is not even satisfactory (cf. equation 3). Only the solvent polarity parameter gives major contribution. It alone contributed for ca. 88 % of the data. The solvatochromic parameters like  $\beta$  and  $\alpha$  play relatively minor roles and contributed less.

We also used Swain's method for the examination of solvent effect. The data on the solvent effect were analysed by using Swain's equation<sup>13</sup> of cation and anion-solvating concept of the solvents (Equation 7).

$$\log k_2 = aA + bB + C \quad \dots\dots\dots (7)$$



Here in above equation, A indicates the anion-solvating power of the solvent and B indicates the cation-solvating power. C is the intercept term and (A+B) is used to indicate the solvent polarity. The rates in different solvents were analysed by using equation (7), separately with A and B and with (A+B).

$$\log k_2 = 0.87 (\pm 0.06) A + 1.63 (\pm 0.05) B - 5.74 \quad \dots\dots\dots (8)$$

$$R^2 = 0.994; SD = 0.04; n = 10; \psi = 0.07$$

$$\log k_2 = 0.52 (\pm 0.72) A - 4.64 \quad \dots\dots\dots (9)$$

$$r^2 = 0.063; SD = 0.53; n = 10; \psi = 1.22$$

$$\log k_2 = 1.52 (\pm 0.24) B - 5.41 \quad \dots\dots\dots (10)$$

$$r^2 = 0.828; SD = 0.23; n = 10; \psi = 0.42$$

$$\log k_2 = 1.35 \pm 0.15 (A + B) - 5.73 \quad \dots\dots\dots (11)$$

$$r^2 = 0.910; SD = 0.16; n = 10; \psi = 0.30$$

Swain's equation (Equation-8) shows an excellent correlation for the rates of oxidation of menthol in different solvents. Only the parameter like cation-solvating power gives major contribution. Cation-solvation alone contributed for *ca.* 83 % of the data (Equation-10). The parameter like anion-solvating power contributed less.

The solvent polarity parameter is represented by (A+B), also contributed for *ca.* 91 % of the data (Equation-11). The rate of reaction was also correlated with the relative permittivity of the solvent. But it was found that, a plot of  $\log k_2$  against the inverse of the relative permittivity is not linear ( $r^2 = 0.679$ ;  $SD = 0.31$ ;  $\psi = 0.59$ ). Indicating that the reaction rate depended on more than one solvent property.

### MECHANISM

As the reaction is showing first order dependence with respect to oxidant,  $H^+$  ion and substrate. These two species should be involved in the slow step. The large increase in reaction rate with increase in acidity suggests the presence of protonated  $Cr^{+6}$  species in the rate determining step.

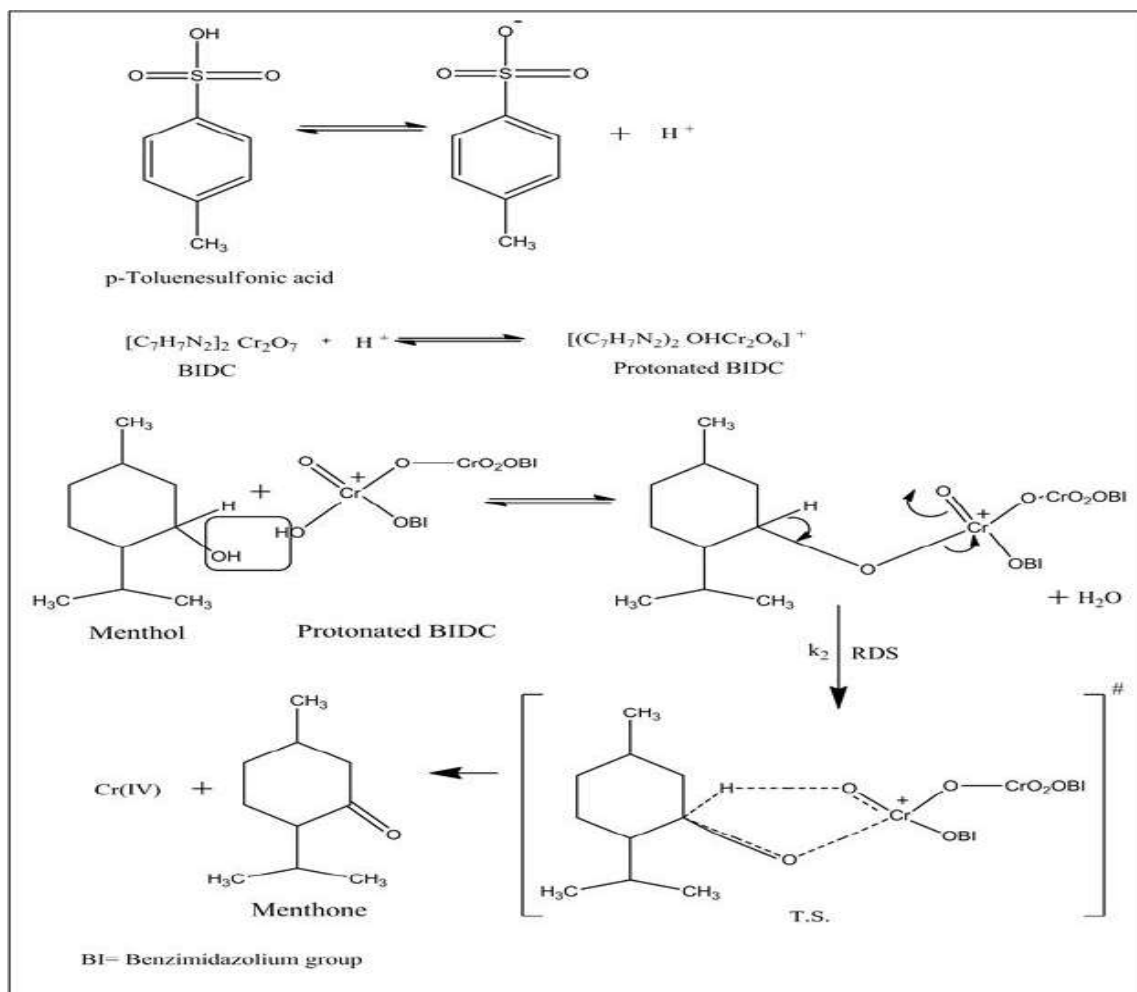
Since the protonation of alcohol is less probable, there is possibility that the proton is used by the BDC. TsOH acts as a proton donor. Solvent dimethyl sulphoxide acts as a weak nucleophile which helps in the dissociation of  $H^+$  ion from TsOH because DMSO is a powerful hydrogen bond acceptor, earlier suggested by Kingsbury<sup>14</sup>.

The formation of chromate ester as an intermediate in a pre-equilibrium step has been reported earlier in chromic acid oxidation<sup>15</sup>, also in the oxidation of alcohols by MCC<sup>5</sup>, QDC<sup>16</sup>, PFC<sup>17</sup>, BTEACC<sup>18</sup> etc.

Bordwell<sup>19</sup> has suggested convincing proof against the occurrence of concerted one-step bimolecular processes by hydrogen transfer. It is well introduced that intrinsically concerted sigmatropic reactions, depicted by transfer of hydrogen in a cyclic transition state, are the only truly symmetrical processes involving a linear hydrogen transfer<sup>20</sup>. Littler<sup>21</sup> has also presented that a cyclic hydride transfer takes place in the oxidation of alcohols by Cr (VI) oxidant which involves six electrons and becomes a Huckel-type of system, is an allowed process. Thus, a transition state having a planar, cyclic and symmetrical structure can be predicted for the decomposition of the ester intermediate.

The protonated BDC and alcohol combine to give intermediate. The rate determining step is the decomposition of the chromate ester via cyclic transition state and it involves the ruptures of  $\alpha$  C-H bond and forming the product<sup>22, 23</sup>.

The overall mechanism suggests the formation of a chromate ester in a fast pre-equilibrium step and then decomposition of the ester intermediate in a subsequent slow step via formation of cyclic concerted symmetrical transition state giving the product. The observed negative value of entropy of activation also supports a polar transition state. The mechanism proposed is shown as below.



## CONCLUSION

The reaction was first order with respect to substrate, oxidizing agent and TsOH concentration. The oxidation of menthol by BIDC failed to induce the polymerization of acrylonitrile, confirms a two-electron transfer reaction. Protonated form of BIDC is the reactive oxidizing species. The oxidation of menthol involves the formation of Dichromate ester which on decomposition giving the product. A  $\alpha$  C-H bond is cleaved in rate-determining step.

## ACKNOWLEDGEMENTS

We are thankful to the Govind Kulkarni, Director, PCCOE, Nigdi, Pune for kind support. We are also thankful to Dr. Indu M. Shastri, Ex Head, Department of Chemistry, R.D. and S.H. National College and S.W.A. Science College, Bandra (W), Mumbai and Professor P. K. Sharma, Ex Registrar and Head, Department of Chemistry, J. N. V. University, Jodhpur for their critical suggestions.

## REFERENCES

1. Bhawana Arora, Jitendra Ojha and Pallavi Mishra. *Oriental J. Chem.*, 2021, 37(3), 626-633.
2. A. P. Kharche, S. Sankhe, V. R. Suryawanshi, H.C. Surani, H. R. Yadav. *European Journal of Molecular & Clinical Medicine*, 2020, 7(10), 3574-3582.
3. Hina Harit, B. L. Hiran and S. N. Joshi. *Chemical Science Transactions*, 2015, 4(1), 49-58.
4. S. S. Mansoor and S. S. Shafi, *Arabian J. Chem.*, 2014, 7(3), 312-318.
5. P. Purohit, S. Kumbhani, I. Shastri, P. K. Sharma. *Oxidation Communications*, 2010, 33(2), 316-326.
6. Q. H. Meng, J.C. Feng, N.S. Bian, B. Leu and C.C Li. *Synthetic Communication*.1998, 28, 1097.
7. Irona Nongkynrih and M.K. Mahanti. *Bull. Chem. Soc. Japan*, 1995, 68, 3325-3329.
8. K.K. Banerji, *Indian J. Chem.*, 1983, 22B, 413.
9. G.P. Panigrahi and D.D. Mahapatro, *Indian J. Chem.*, 1980, 19A, 579.

10. D.D. Perrin, W.L. Armarego, D.R. Perrin. Purification of organic compounds. Pergamon press, Oxford, 1966.
11. M.J. Kamlet, J.L.M. Abboud, M.H. Abraham, R.W. Taft. *J.Org. Chem.* 1983, 48, 2877.
12. O. Exner. *Collect. Chem. Czech.Comm.* 1973, 38, 411.
13. C. G. Swain, M.S. Swain, A.L. Powell, S. Alumni. *J.A.C.Soc.* 1983, 105, 502.
14. C. A. Kingsbury, *J. Org. Chem.*, 1964, 29(11), 3262-3270
15. K. B. Wiberg, *Oxidation in Organic Chemistry, Part A*; Academic Press New York, 1965, 69.
16. Irona Nongkynrih and M.K. Mahanti. *Bull.Chem.Soc.Japan*, 1996, 69, 1403-1407.
17. R.Khanchandani, K.K. Banerji, P. K. Sharma. *J. Indian Chem. Soc.*, 1998, 75, 42.
18. R. Kaur, N. Soni and Vinita Sharma, *Indian Journal of Chemistry*, 2006, 45A, 2441-2445.
19. F. G. Bordwell. *Acc. Chem. Res.*, 1972, 5, 374.
20. R. W. Woodward, R. Hoffmann: *The Conservation of Orbital Symmetry*. *Angew. Chem. Int. Ed. Eng.*, 1969, 8, 781.
21. J. S. Litler: *Oxidation of Olefins, Alcohols, Glycols and Other Organic Compounds by Inorganic Oxidants such as Cr (VI), Mn (VII), I(VII), Pb (IV), V(V) and Halogens, Considered in the Light of the Reaction Rules for Electrocyclic Reactions*. *Tetrahedron*, 1971, 27, 81.
22. K. K. Banerji, *J. Org. Chem.*, 1988, 53(10), 2154-2159.
23. K. K. Banerji, *European Chem. Bull.*, 2013, 2(10), 816-824.

## First Report of Microcystin and Cylindrospermopsin in the Dal Lake, Kashmir: *In-Silico* Bioactivity Analysis of Cyanotoxins

Fahim Bashir<sup>1</sup>, Rongwei Shi<sup>2</sup>, Khalid M. Fazili<sup>3</sup> and Bashir Ahmad Ganai<sup>4\*</sup>

<sup>1</sup>Department of Environmental Science, University of Kashmir, Srinagar, 190006, Jammu and Kashmir, India  
&

Aquatic Ecology Laboratory, Center of Research for Development (CORD), University of Kashmir, Srinagar, 190006, Jammu and Kashmir, India

<sup>2</sup>Department of Materials Science, School of Material and Chemical Engineering, Tongren University, Guizhou 554300, P.R. China

<sup>3</sup>UPR Signaling Laboratory, Department of Biotechnology, University of Kashmir, Srinagar, 190006, Jammu and Kashmir, India

<sup>4</sup>Aquatic Ecology Laboratory, Center of Research for Development (CORD), University of Kashmir, Srinagar, 190006, Jammu and Kashmir, India

### ABSTRACT

Dal Lake, also known as “Srinagar’s jewel” is situated in the Union territory of Jammu and Kashmir (J&K), the northern-most territory of India. The preeminent freshwater body, known worldwide for harboring rich, ethnic biodiversity also embraces itself as an excellent recreational site. However, over the last few decades, the freshwater aquatic ecosystem has been reported to have experienced accelerated eutrophication, frequent harmful bloom formation, and a decrease in the biological diversity of the habitat. The present study aimed to characterize cyanotoxins responsible for toxin biosynthesis from the field samples. Characterization of cyanotoxins responsible for bloom formation was carried out by Orbitrap Fusion Tribrid mass spectrometer coupled to an Easy-nLC-1200 nanoflow liquid chromatography system. The structural information on cyanotoxins was then determined based on the fragmentation patterns (m/z) obtained by LC-MS/MS. Further, in-silico analyses were performed to identify their most probable targets and docking interactions studies with these targets using the SwissTargetPrediction tool and Autodock program, respectively. LC-MS/MS analysis confirmed a total of three microcystin variants and one cylindrospermopsin variant in the bloom sample from the lake. The analyses predicted cyanotoxins show affinity towards all the selected targets, however, cylindrospermopsin represents the best affinity towards ITGAV/B3, MC-WR has the highest affinity towards BACE 1, CDK2/Cyclin A and PRM1, [Gly<sup>1</sup>,Asp<sup>3</sup>,ADMAdda<sup>5</sup>,Dhb<sup>7</sup>]MC-LR has the weakest affinity towards ITGAV/B3 and PRM1. Binding energies also emphasize that the order of affinity of cyanotoxins towards these targets is similar to that reported in target prediction analyses. This is the first detailed study for identifying cyanotoxin variants in Dal Lake by using wet-lab and in-silico analyses.

Keywords: Dal Lake, Microcystin, Cylindrospermopsin, LC-MS/MS, Docking interactions

### 1. INTRODUCTION

Cyanobacterial harmful algal blooms (cHABs) and their associated secondary metabolites (cyanotoxins) are an increasingly frequent phenomenon in aquatic systems. As a result of anthropogenic pressures, global warming, and eutrophication these blooms have become a worldwide issue [1-3]. Under suitable environmental conditions, these blooms have the potential to produce a wide variety of bioactive specialized metabolites which include hepatotoxins: microcystins and nodularins, neurotoxins: anatoxin-a, and saxitoxin, cytotoxins: cylindrospermopsin [4]. Around 2010 cyanobacterial specialized metabolites (CSMs) have been structurally identified from diverse sources to date [5].

Many toxin-producing cyanobacteria such as *Microcystis*, *Dolichospermum*, *Nodularia*, *Raphidiopsis*, *Lyngbya*, *Microcoleus*, *Oscillatoria*, *Aetokthonos hydrillicola*, etc are well known to cause mortality in pets, humans, livestock, wildlife, and potential cancer development through drinking and recreational waters [6-11]. The potential chronic toxicity of cyanotoxins led the WHO to establish the provisional guideline values (GVs) in drinking water, and recreational water. The GV for cylindrospermopsin (CYN) in short-term, long-term drinking water and recreational water are 3 µg/L, 6 µg/L, and 0.7 µg/L, respectively [12]. For MC-LR (Microcystin-leucine-arginine), the GV for short-term, lifetime drinking water, and recreational water are 12 µg/L, 1 µg/L, and 24 µg/L, respectively [13].

Despite the recognition of their biotoxicity, the bioactivities of metabolites have long been recognized, making them lead compounds for the development of drugs [14-16]. Pharmaceutical research actively explores their

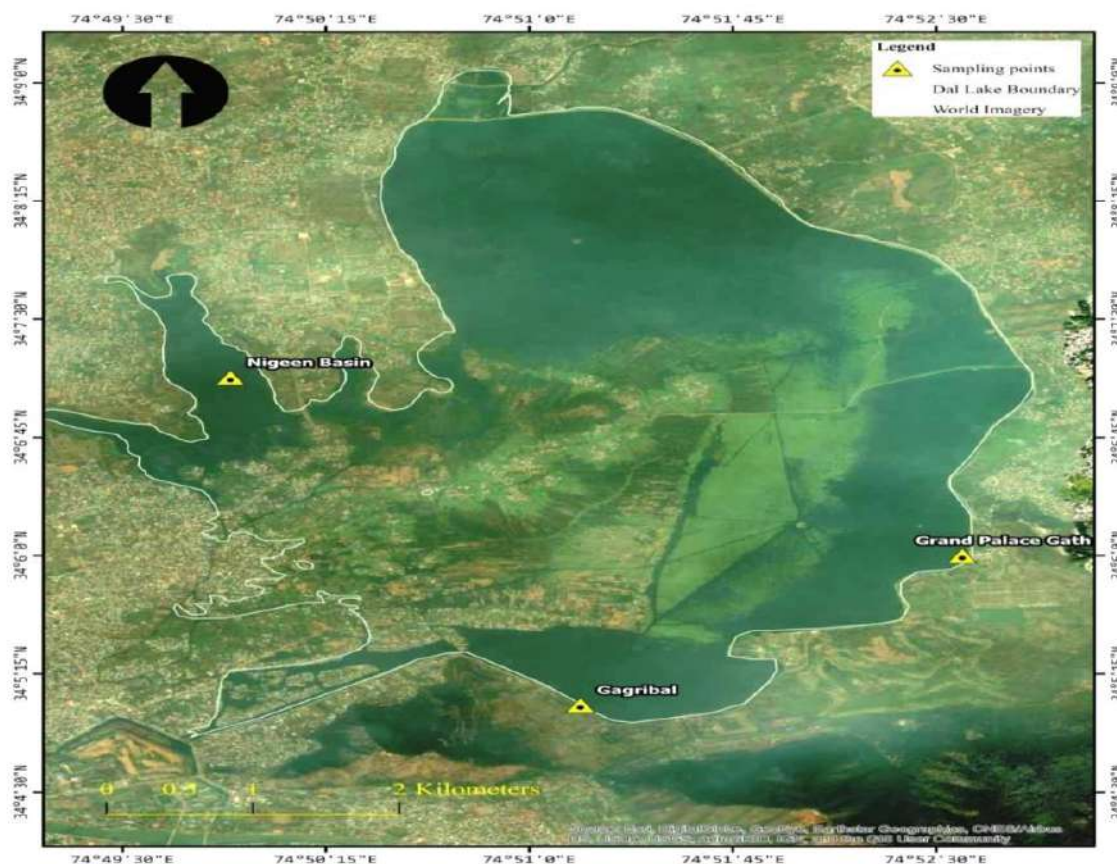
use, e.g., to fight cancers, cardiac and autoimmune disorders, or infectious diseases such as Covid-19 [17, 18]. Besides, several CSMs show antimicrobial or antifungal activity [4, 19].

Dal Lake serves as an essential source of palatable water for grazing animals and birds besides, the aquatic ecosystem that it beholds. Since the past three decades, many cyanobacterial blooms have been observed in Dal Lake. Due to the increased frequency, duration, and intensity of cHABs in the lake, it becomes immensely important to identify the distribution of cyanotoxins in the lake. Thus, in the present study, bloom samples were collected using plankton nets. The blooms were then examined and identified through microscopic examination.

## 2. MATERIALS AND METHODS

### 2.1. Sampling Sites and Samples Collection

Dal Lake (34.0625° N, 74.5010° E) is a world-famous Himalayan urban lake in the union territory of J&K, India's northernmost union territory. At 1,583 m above sea level, Dal Lake is Kashmir's second-largest freshwater lake, with a volume of over  $983 \times 10^6 \text{ m}^3$ , a maximum depth of 20 ft., and a surface area of  $368 \text{ km}^2$ . However, the water quality of Dal Lake has deteriorated considerably over the last two decades due to anthropogenic activities. In this study, a one-year (2017) survey was conducted in this lake. A total of three sampling sites from the lake were chosen for the present study namely, Grand Palace Gath (34.1000 °N, 74.8766 °E), Nigeen basin (34.1182 °N, 74.8317 °E), and Gagribal basin (34.0824 °N, 74.8493 °E) (Figure 1). The bloom samples (approx. 0.5 L of water) collected were stored immediately in a portable refrigerator (4 °C) and brought back to the laboratory for further identification and analysis of cyanotoxins.



**Figure 1:** Map showing locations of study sites in Dal Lake

## 2.2. MORPHOLOGICAL IDENTIFICATION

### 2.2.1. Microscopy

Field samples were observed using an inverted microscope, attached with a charged coupled device camera, and examined under 400X magnification. The preliminary microscopic examination of the crude samples employed several taxonomic keys for identification of the isolates, utilizing different morphological attributes such as colony/filament type, cell shape, and size, whether having specialized cells or not [20-23] and other web databases and sites available which are relevant for the taxonomic classification and nomenclature of toxigenic cyanobacteria like CyanoDB [24], AlgaeBase [25], Cyanosite (<https://www-cyanosite.bio.purdue.edu>).

### 2.3. Toxin Isolation and Analysis

For extracting cyanotoxins, 250 mL of bloom sample were harvested by centrifugation at 4000 *g* for 20 min and lyophilized. Approximately 10 mg of the lyophilized biomass was then mixed with 8.0 mL of 70 % (v/v) methanol (MeOH), and 0.1 % formic acid [26, 27]. For toxin recovery, cells were then subjected to disruption using ultra-sonic waves generated during the sonication process (Phoenix PHUC-40 2 L 50 W) in an ice bath for 5 min [28-30]. The extracted material was then centrifuged at 10,000 rpm for 10 min and the supernatant was retained for further analysis [31, 32].

#### 2.3.1. StageTip Based Cleanup of Extracted Samples Using C18 Material

C-18 StageTip method was used for initial cleanup. The C-18 material (3M Empore) was also packed into 200  $\mu$ L tips and activated with 100 % acetonitrile (ACN), followed by equilibration using 0.1 % formic acid. The sample was resuspended in 0.1 % formic acid and loaded onto the C-18 StageTip column which is ready after equilibration. The sample loading is repeated thrice to reduce the loss of the sample. It was further washed with 0.1 % formic acid thrice, and elution was carried out with 40 % ACN in 0.1 % formic acid and dried. The desalted and dried samples were stored at  $-20^{\circ}\text{C}$  until mass spectrometry analysis.

#### 2.3.2. LC-MS/MS analysis

Toxin determination in all samples was performed by liquid chromatography-tandem mass spectrometry (LC-MS/MS) using Orbitrap Fusion Tribrid mass spectrometer (Thermo Fischer Scientific, Bremen, Germany) connected to Easy-nLC-1200 nanoflow liquid chromatography system (Thermo Scientific) was used for data acquisition. Cleaned and dried samples were reconstituted in 0.1% formic acid before mass spectrometry analysis. The sample was loaded onto a 2 cm trap column (nanoViper, 3  $\mu$ m C18 Aq) (Thermo Fisher Scientific,). The sample was loaded onto a 2 cm trap column (nanoViper, 3  $\mu$ m C18 Aq) (Thermo Fisher Scientific). Separation was done using a 15 cm analytical column (EASY-Spray column PepMap RSLC, C18, 2  $\mu$ m, 100 A, 75  $\mu$ m x 50 cm) at a flow rate of 300 nL/min. The solvent gradients were set as a linear gradient of 5–35 % solvent B (80 % ACN in 0.1 % formic acid) for 90 min the total run time for each fraction was 120 min. Global MS survey scan was carried out at a scan range at *m/z* 80–1200 (120,000 mass resolutions at *m/z* 200) in a data-dependent mode using an Orbitrap mass analyzer. The maximum injection time was 50 msec. Only precursor ions with charge states 2–6 were considered for analysis, and the dynamic exclusion rate was set to 30 sec. For MS/MS analysis, data was acquired at top speed mode with 3-sec cycles and subjected to higher collision energy dissociation with 34 % normalized collision energy. MS/MS scans were carried out at the *m/z* range of 100–2000 using an Orbitrap mass analyzer at a resolution of 30,000 at 200 *m/z*. The maximum injection time was 200 msec.

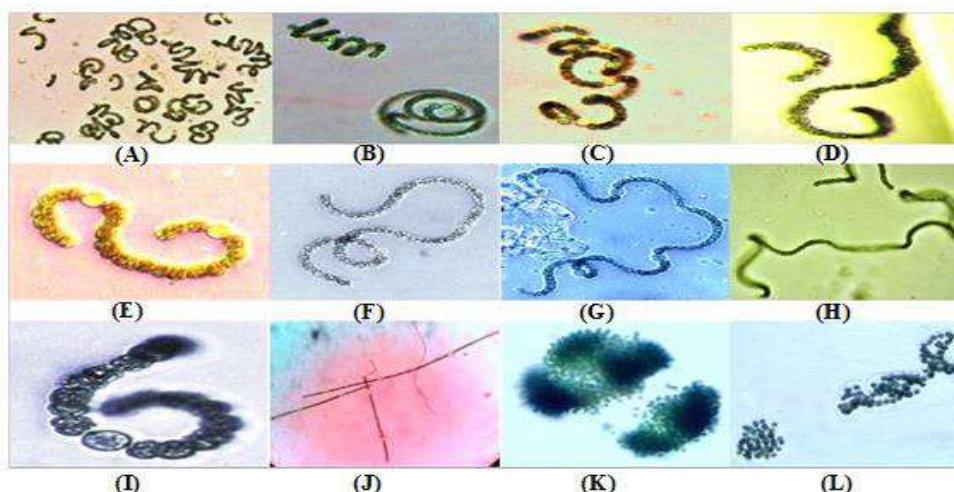
### 2.4. In Silico Bioactivity Analysis of Cyanotoxins

The identified three MC variants and CYN were screened for their bioactivity, initially by predicting the most probable targets/receptors inside the cell by using the SwissTargetPrediction online tool [33] and then performing docking studies against selected targets to analyze ligand-target interaction by using the Autodock 4.0 program [34]. For docking studies, crystal structures integrin  $\alpha$ -V/ $\beta$ -3 (PDB ID: 1JV2), human  $\beta$ -secretase 1 (BACE 1, PDB ID: 3DV1), cyclin-dependent kinase CDK2/Cyclin A (PDB ID: 4BCQ), and ribonucleoside-diphosphate reductase 1- $\alpha$  subunit (A-H chains) (PDB ID: 5CNS), were retrieved from Protein Data Bank [35]. All the structures were prepared by removal of waters, inhibitors, protonating 3D, repairing missing residues, and energy minimized. Partial or whole protein was used for docking depending on the type of protein. Total 100 poses were retained and the final pose was selected depending on binding energy and type of interactions. For each cyanotoxin, 3D poses were generated by using Discovery Studio Visualizer, and cartoon and sphere models were generated by using UCSF Chimera software [36, 37].

## 3. RESULTS

### 3.1. Identification of Cyanobacteria from Bloom Samples

Preliminary microscopic examinations of the three bloom samples collected in October 2017, showed the prevalence of different cyanobacterial species from different parts of Dal Lake, each depicting unique and distinct morphological attributes (Figure 2).



**Figure 2:** Micrographs of Cyanobacteria in Dal Lake, Kashmir (A-I) *Dolichospermum* sp. (J) *Anabaena* sp. (K, L) *Microcystis* sp.

The morphospecies present in the bloom samples collected from Grand Palace Gath and Gagribal basin were found to be filamentous and showed the presence of specialized heterocyst cells thus representing typical characteristics exhibited by members of the family Nostocaceae. However, both the filamentous morphospecies differed markedly in the overall similitude of the filaments owing to its multicellular nature that arises as a result of the linking pattern of individual cells imparting the filament its inimitable structure. Filaments of the morphospecies observed in the Grand Palace Gath tend to be coiled into a spiral architecture; individual vegetative cells appear globose in shape with prominently differentiated heterocyst cells (Figure 2, A-I) while the individual cells in the morphospecies observed in the Gagribal basin were cylindrically shaped vegetative cells with ovoid heterocyst linked in a way that manifests into a more ordered, straight and unbranched filaments thereby, facilitating discrimination between the two morphospecies as two different cyanobacterial species (Figure 2, J). The dominant morphospecies collected from the Nigeen basin showed spherical cells grouped in colony-forming behavior which are remarkable characters of the genus *Microcystis* (Figure 2 K, L).

### 3.2. Identification and Characterization of Cyanotoxins

A total of four cyanotoxins belonging to two different classes were determined by LC-MS/MS analysis and confirmed the presence of three MC variants (MC-WL, MC-WR, MC-LR), and one CYN variant had been detected from the field sample at S2 as shown in Table 1.

**Table 1:** Cyanotoxins in the bloom sample from Dal Lake, Kashmir by LC-MS/MS analysis

S.No	m/z	Cyanotoxins detected	Fragment/s	Query sequence (Reference Organism)	Blastp (Similarity)
1.	1025.07	MC-WL	Mdha-Ala-X-Masp-Leu+NH <sub>4</sub>	GRPQDMFSDTGIQLQPI F ( <i>M.aeruginosa</i> PCC7806)	McyE (100.00%)
2.	1066.64	MC-WR	Glu-Mdha+H	LTDPDEAVDFVERTQV DAL ( <i>M.aeruginosa</i> PCC7806)	McyD (71.43%) McyA (100.00%) McyE (83.33%)
3.	995.51	[Gly <sup>1</sup> , Asp <sup>3</sup> , ADMAdd <sup>a5</sup> , Dhb <sup>7</sup> ]MC-LR	Leu-(Me)Asp+H; Glu-Mdha/Dhb-Gly/Ala Leu+H	FQSYKEGQDNVVIVGP LP ( <i>M.aeruginosa</i> PCC7806)	McyG (57.14%)
4.	416.24	Cylindrospermopsin	[M-C <sub>5</sub> H <sub>6</sub> N <sub>2</sub> O <sub>3</sub> +H] <sup>+</sup>	SFRNTTPDPESGAKR ( <i>C.raciborskii</i> AWT205)	Mixed NRPS/PKS (100.00%) Aoac (80.00%)

#### 3.2.1. Cyanotoxin 1: MC-WL, [M+H]<sup>+</sup> = 1025.07

The results obtained from LC-MS/MS scans detected the presence of three MC variants. A total of about 300 MC variants had been reported to date. The variant with molecular ion (C<sub>54</sub>H<sub>73</sub>N<sub>8</sub>O<sub>12</sub>) at m/z 1025.07 showed a single base peak as evident from the MS spectrum and a diagnostic ion of MC variant, MC-WL (Microcystin-tryptophan-leucine) (Figure 3A). Its MS<sup>2</sup> spectrum showed several products, of which, the fragmentation product, Mdha-Ala-X-Masp-Leu+NH<sub>4</sub> at m/z 599.26 further aids in the identification of MC-WL.

### 3.2.2. Cyanotoxin 2: MC-WR, $[M+H]^+ = 1066.64$

Another MC variant detected through the analytical procedure, showed a single, prominent base peak in its MS spectrum with  $m/z$  at 1066.64, a diagnostic ion of MC-WR (Microcystin-tryptophan-arginine). The molecular ion,  $C_{54}H_{74}N_{11}O_{12}$  in its  $MS^2$  spectrum also depicted several fragmented products at different  $m/z$  values. The product, Glu-Mdha+H at  $m/z$  213.08 further confirms the identity of the MC variant as MC-WR (Figure 3B).

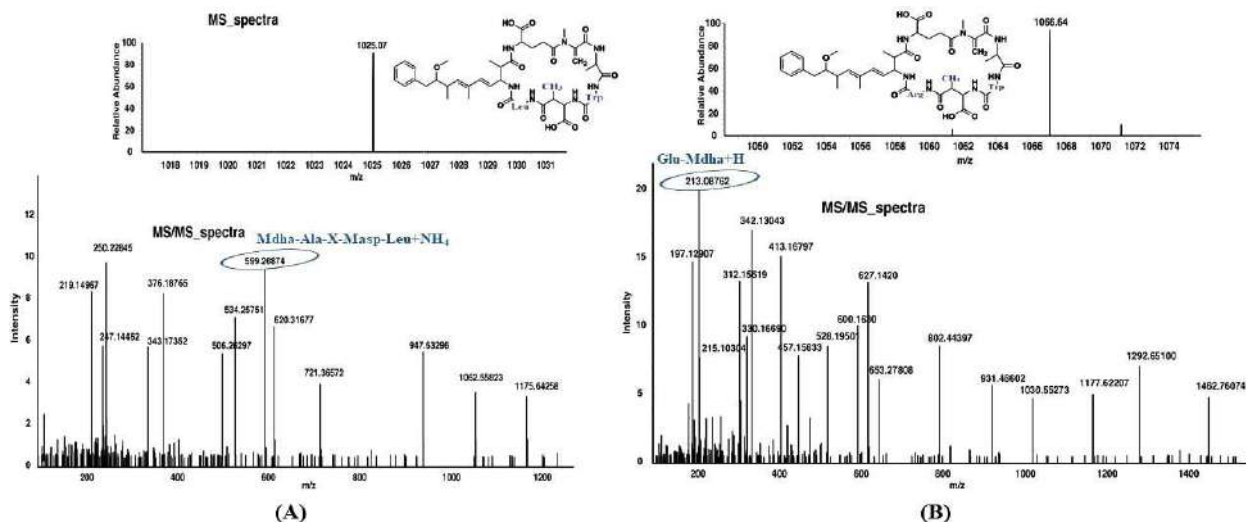


Figure 3. LC-MS/MS scans of (A) MC-WL (B) MC-WR

### 3.2.3. Cyanotoxin 3: $[Gly^1, Asp^3, ADMAdda^5, Dhb^7] MC-LR, [M+H]^+ = 995.51$

The third MC variant had been identified as  $[Gly^1, Asp^3, ADMAdda^5, Dhb^7] MC-LR$  (Microcystin-leucine-arginine) (Figure 3C). In the MS spectrum, the base peak occurring with  $m/z$  at 995.5 is the diagnostic ion for the MC variant. Further, the fragmentation products: Leu-(Me)Asp+H ( $m/z$  229.15), and Glu-Mdha/Dhb-Gly/Ala-Leu+H ( $m/z$  383.22) in the  $MS^2$  spectrum further decipher the identity of the toxin variant.

### 3.2.4. Cyanotoxin 4: CYN, $[M+H]^+ = 416.24$

Besides, the above-mentioned MCs, the environmental bloom sample contained the cyanotoxin, CYN. Only one of the CYN analog *viz.*, CYN from the five known CYN analogs was detected in the LC-MS spectrum that has been shown to form  $[M+H]^+$  ion of  $m/z$  416.24, which is characterized by the presence of dominant  $MS^2$  ion at  $m/z$  175.15 due to the subsequent loss of  $H_2O$  and  $SO_3$  molecules from  $[6-(2-hydroxy-4-oxo-3-hydropyrimidyl)]$  hydroxymethyl part of CYN  $[M-C_3H_6N_2O_3+H]^+$  ion (Figure 3D).

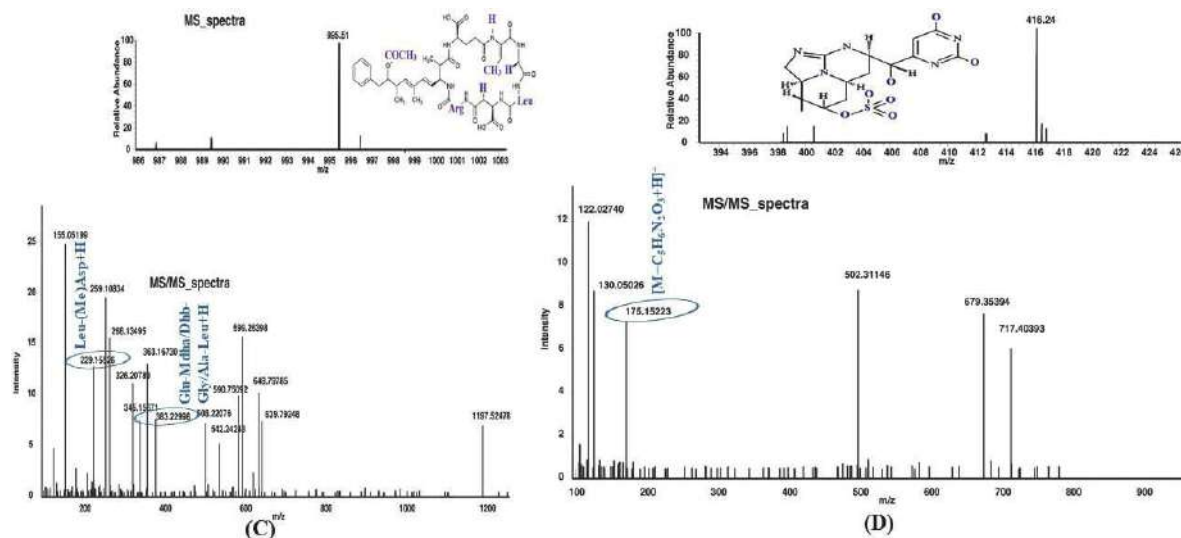


Figure 3: LC-MS/MS scans of (C)  $[Gly^1, Asp^3, ADMAdda^5, Dhb^7] MC-LR$  (D) Cylindrospermopsin. Fragmentation induced by Orbitrap Fusion Tribrid mass analyzer.

Mdha: *N*-methyldehydroalanine; Ala: Alanine; Masp: Erythro-beta-methylaspartic acid; Leu: Leucine; Trp: Tryptophan; X: Trp; Glu: Glutamic acid; Arg: Arginine; Gly: Glycine; Dhb: Dehydrobutyryne; Glu: Glutamic acid; Mdha: *N*-methyldehydroalanine; Ala: Alanine; MeAsp: Methylaspartic acid



### 3.3. In-Silico Bioactivity Analysis of Cyanotoxins

#### 3.3.1. Target Prediction

Several targets were predicted against the MC-WL, MC-WR, [Gly<sup>1</sup>, Asp<sup>3</sup>, ADMAdda<sup>5</sup>, Dhb<sup>7</sup>]MC-LR and CYN with varying probabilities and known active compounds based on 3D and 2D similarity searches from a large library of compounds and proteins from different species. Among these, high-profile target classes were membrane receptors, proteases, kinases, and oxidoreductases.

From membrane receptors, different types of integrins were found most probable and common targets for all types of cyanotoxins under investigation. Out of which integrin alpha-IIb/beta-3 (ITGA2B/B3) and integrin alpha-V/beta-3 (ITGAV/B3) were found most suitable with high probability and known number of similar active compounds, as given in Table 2. Integrins are heterodimers with different combinations of  $\alpha$  and  $\beta$  subunits generating different isoforms with varying activity. They are involved in several biological functions such as attachment of cells to the extracellular matrix, cell-cell adhesion, cell migration, signal transduction, and receptors for certain viruses including coronaviruses [38-40]. Integrin ITGA2/B3 is responsible for blood clotting in thrombocytes, whereas ITGAV/B3 plays a major role in tumor invasion, angiogenesis, and phagocytosis [38, 40, 41]. From Proteases, the most probable and common target was beta-secretase 1 (BACE1) which represented the highest number of known active similar compounds than other targets, as provided in Table 2. Beta-secretase is involved in the deposition of toxic amyloid  $\beta$  plaque which plays a crucial role in Alzheimer's diseases [42]. Thus, it acts as a therapeutic target for Alzheimer's disease.

The third most probable target was cyclin-dependent kinase 2 (CDK2) which belongs to kinases. CDK2 complex with cyclin A involved in the phosphorylation process and regulates the progression of the S phase of the eukaryotic cell cycle. Therefore, it acts as a promising anticancer drug target, especially in breast cancer [43, 44]. Another most suitable and common target for investigational cyanotoxins was ribonucleoside-diphosphate reductase (PRM1), which belongs to oxidoreductases as given in Table 2. It converts ribonucleotides to deoxyribonucleotides which is a vital reaction for DNA biosynthesis and repair. PRM1 is a target for gemcitabine which is an effective drug for non-small cell lung cancer and pancreatic cancer [45-47]. Overall target prediction analysis for these cyanotoxins indicates their promising role in cancer treatment, prevention of viral infections, and treatment of neural disorder which also coincides with previously reported studies [48-50].

**Table 2:** Binding energies of cyanotoxins (1-4) with selected targets, obtained through molecular docking studies

S.No.	Targets	PDB ID	Binding Energies of cyanotoxins in kcal.mol <sup>-1</sup>			
			1	2	3	4
1.	ITGAV/B3	1JV2	-6.11	-6.26	-4.22	-8.84
2.	BACE 1	3DV1	-6.02	-9.10	-6.68	-8.65
3.	CDK2/ Cyclin A	4BCQ	-8.45	-9.65	-8.00	-5.96
4.	PRM1	5CNS	-8.06	-8.49	-5.80	-7.22

#### 3.4. Docking Interactions

The molecular docking study of cyanotoxins with selected targets as mentioned in Table 2, was processed through docking interaction by using the Autodock 4.0 program [34]. For each target, the most suitable binding pose was selected depending on binding energies and the type of ligand-target interactions.

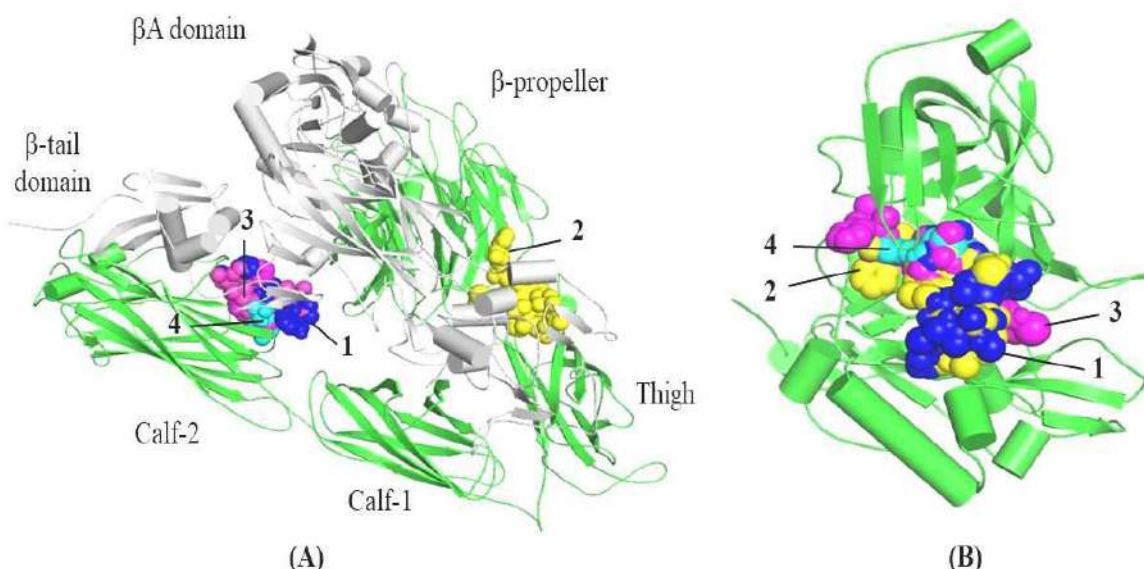
##### 3.4.1. Docking with Integrin A-V/B-3

Crystal structure of the extracellular domain of integrin alpha-V/beta-3 (PDB ID: 1JV2), the whole protein was considered for binding of cyanotoxins as blind docking. Each cyanotoxin represented different binding sites, energy values, and types of interactions. The highest binding energy value for each cyanotoxin is provided in Table 2 and various binding sites and poses are depicted in Figure 4A. Docking study indicates that CYN has the highest affinity as compared to others, with the binding energy of  $-8.84 \text{ kcal.mol}^{-1}$  and the binding site is located in between the  $\beta$ -propeller and Calf-2 domain of  $\alpha$  subunit. MC-WL and [Gly<sup>1</sup>, Asp<sup>3</sup>, ADMAdda<sup>5</sup>, Dhb<sup>7</sup>]MC-LR lie in between the similar binding site of the  $\alpha$  subunit with binding energies of  $-6.11$  and  $-4.22 \text{ kcal.mol}^{-1}$ , respectively. It is noted that MC-WR binds to a different site located in between  $\beta$ -propeller and Thigh domain of  $\alpha$  subunit with the binding energy of  $-6.26 \text{ kcal.mol}^{-1}$ .

##### 3.4.2. Docking with $\beta$ -secretase 1

Crystal structure of human  $\beta$ -secretase 1 (BACE 1, PDB ID: 3DV1) chain A was used to analyze the binding of cyanotoxins in the active site of an enzyme. The molecular docking study indicated that cyanotoxin 4 lie inside the cavity of the enzyme, which is similar to that of the co-crystallized inhibitor AR9. Nevertheless, MC-WL,

MC-WR, and [Gly<sup>1</sup>, Asp<sup>3</sup>, ADMAdda<sup>5</sup>, Dhb<sup>7</sup>]MC-LR) bind at the entrance of the active site cavity rather than inside the cavity, the reason might be the larger size of these cyanotoxins as compared to CYN, as shown in Figure 4B. MC-WR represented the best affinity as compared to other peptides, representing binding energy of  $-9.10 \text{ kcal.mol}^{-1}$ , followed by CYN, [Gly<sup>1</sup>, Asp<sup>3</sup>, ADMAdda<sup>5</sup>, Dhb<sup>7</sup>]MC-LR) and MC-WL, with binding energies of  $-8.65$ ,  $-6.68$ ,  $-6.02$ ,  $\text{kcal.mol}^{-1}$ , respectively as given in Table 2.



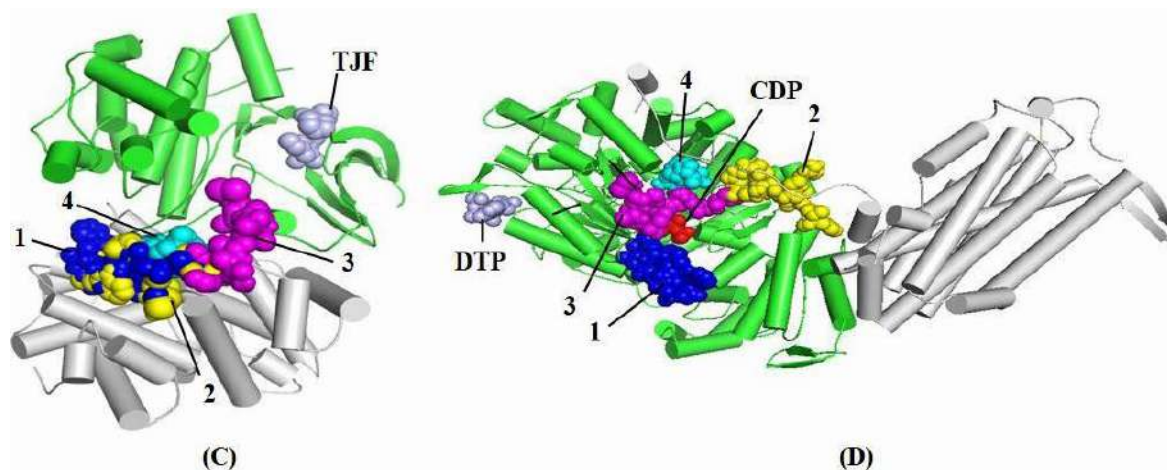
**Figure 4.** 3D cartoon model of the (A) Extracellular domain of integrin alpha-V/beta-3 (PDB ID: 1JV2) with alpha (green) and beta (light grey) subunits. Different regions of integrin are labeled in black. Cyanotoxins (1–4) are also labeled and shown in the sphere model having different colors (blue, yellow, magentas, and cyan respectively) with different binding sites (B) Crystal structure of human  $\beta$ -secretase 1 (PDB ID: 3DV1) chain A (PDB ID: AR9). Binding poses of cyanotoxins 1, 2, 3, and 4 are shown in blue, yellow, magentas, and cyan sphere models, respectively

### 3.4.3. Docking with CDK2

The active site of CDK2/Cyclin A (PDB ID: 4BCQ) was used to analyze the interaction of cyanotoxins. Molecular docking studies indicated that MC-WL, MC-WR, and [Gly<sup>1</sup>, Asp<sup>3</sup>, ADMAdda<sup>5</sup>, Dhb<sup>7</sup>]MC-LR) represented better interaction having binding energies of  $-8.45$ ,  $-9.65$ , and  $-8.00 \text{ kcal.mol}^{-1}$  respectively as compared to CYN, as given in Table 2. Due to the larger size, the positions of MC-WL, MC-WR, and [Gly<sup>1</sup>, Asp<sup>3</sup>, ADMAdda<sup>5</sup>, Dhb<sup>7</sup>]MC-LR) are located at the border of CDK2 and Cyclin A, which was far away from the small binding site of the co-crystallized inhibitor TJF (light blue) around the N-terminal Cyclin A as shown in Figure 4C. Surprisingly, CYN, located at the interface of CDK2 and Cyclin A, has a similar size with the co-crystallized inhibitor TJF, but with notably different binding sites, which might be due to steric hindrance and the polycyclic structure.

### 3.4.4 Docking with Ribonucleoside-Diphosphate Reductase 1

Ribonucleoside-diphosphate reductase 1–alpha subunit (A–H chains) (PDB ID: 5CNS), inhibited with dATP which is co-crystallized (ID: DTP), was retrieved from PDB, and chains A and F were analyzed for docking studies of cyanotoxins as blind docking. The positions of all cyanotoxins were shifted outward to the surface of  $\alpha$  subunit (chain A) than that of the co-crystallized substrate CDP (red sphere model) as shown in Figure 4D. Binding energies for all cyanotoxins are provided in Table 2. The highest affinity poses from MC-WL and MC-WR (blue and yellow sphere model) with similar binding energies of  $-8.06$  and  $-8.49 \text{ kcal.mol}^{-1}$  is shown in Figure 4D. CYN and [Gly<sup>1</sup>, Asp<sup>3</sup>, ADMAdda<sup>5</sup>, Dhb<sup>7</sup>]MC-LR) (cyan and orange sphere model) with a moderate binding affinity ( $-7.22$  and  $-5.80 \text{ kcal.mol}^{-1}$ ) are also shown in Figure 4D. These poses represented different binding sites as compared to the co-crystallized substrate CDP and inhibitor DTP (light blue sphere model); however, this binding may affect conformational modifications in the active site which may halt the further reaction. A similar type of interaction may also be observed with other chains of the same enzyme.



**Figure 4:** 3D cartoon model of the (C) CDK2/Cyclin A (PDB ID: 4BCQ) with CDK2 chain A (green) and Cyclin (light grey). The binding pose of cyanotoxins 1, 2, 3, and 4 are shown in blue, yellow, magentas, and cyan sphere models, respectively. The co-crystallized inhibitor TJF is represented by the light blue sphere model (D) Ribonucleoside-diphosphate reductase 1- $\alpha$  subunit (PDB ID: 5CNS). The chains A and F are colored green and light grey, respectively. The binding pose of cyanotoxins 1, 2, 3, and 4 are shown in blue, yellow, magentas, and cyan sphere models, respectively. The co-crystallized inhibitor DTP and substrate CDP are represented by the light blue and red sphere model.

#### 4. DISCUSSION

The proliferation of cyanobacteria, including its toxic species, has been dominating water bodies across the world. In particular, cHABs have contaminated lakes, lagoons, and beaches around the globe. These cHABs are likely to expand further in the coming decades due to changing environmental factors, including a rise in temperature, global CO<sub>2</sub> warming, and eutrophication. Moreover, these cHABs are poisonous, and their exposure causes severe complications to both humans and animals. Both harmful and nuisance cyanobacterial blooms affect seafood production and the tourism sector, leading to health issues and heavy economic losses. This is the first detailed study on the co-occurrence of more than one cyanotoxin variant in the sampling site of the lake.

Analysis of cyanobacterial extracts through LC-MS/MS confirmed the presence of three MC variants and one CYN in the crude, water sample collected from the S2 through LC-MS/MS. MS/MS analyses are confirmed based on product ions formed in mass spectrometry. In the MS<sup>2</sup> fragmentation spectrum of MCs, the following dominant ions are observed in the MS/MS spectrum: Glu-Mdha+H ( $m/z$  213), Mdha-Ala-X-Masp-Leu+NH<sub>4</sub> ( $m/z$  600), Leu-(Me)Asp+H ( $m/z$  229), and Glu-Mdha/Dhb-Gly/Ala-Leu+H ( $m/z$  383) [51, 52]. The MC-WL, MC-WR, and [Gly<sup>1</sup>,Asp<sup>3</sup>,ADMAdda<sup>5</sup>,Dhb<sup>7</sup>]MC-LR ( $m/z$  1025.07, 1066.64, 995.51) has been shown to form MS<sup>2</sup> product ions of  $m/z$  599.26 for MC-WL,  $m/z$  213.08 for MC-WR and  $m/z$  229.15, 383.22 for [Asp<sup>3</sup>,ADMAdda<sup>5</sup>,Dhb<sup>7</sup>]MC-LR. For CYN, the spectrum has been shown to form a product ion of  $m/z$  416.45, which is characterized by the presence of a dominant MS<sup>2</sup> ion at  $m/z$  175.11 [27, 53].

Several, pharmaceutical activities of the toxic metabolites produced by cyanobacteria had been reported based on their specific interactions with their natural targets. For instance, ATX is used as larvicides [54-56]; MCs possess algicidal, herbicidal, larvicidal, anticancerous activities [49, 56]; CYN has antiviral drug-like properties (potential inhibitor of SARS-CoV-2 proteases), used for the development of biocides such as larvicides [18, 56, 57] and NOD is also known for its antiviral drug-like properties (potential inhibitor of SARS-CoV-2 protease) and anticancerous activities [49]. Thus, to determine the pharmacological potential of the studied cyanotoxins i.e., MCs, and CYN, *in-silico* bioactivity analyses were also performed in the present study using compounds obtained in LC-MS/MS analysis. The performed *in-silico* analyses showed that among predicted targets, cylindrospermopsin represents the best affinity towards ITGAV/B3, MC-WR has the highest affinity towards BACE 1, CDK2/Cyclin A and PRM1, and [Gly<sup>1</sup>,Asp<sup>3</sup>,ADMAdda<sup>5</sup>,Dhb<sup>7</sup>]MC-LR has the weakest affinity towards ITGAV/B3 and PRM1, which are associated with viral infections (including Corona Virus), various type of tumors/cancers, and neural diseases (Alzheimer's disease). Thus, the present study, apart from being the first of its kind to be reported from Dal Lake, shows the utmost need to frequently monitor water bodies for water quality and to carry out checks for the detection of cyanotoxins that would otherwise lead to deterioration of health of the overall ecosystem. There also appears a crucial need to emphasize studies on genetic diversity

of the cyanobacterial strains, factors influencing bloom dynamics, and development of therapeutic drugs using cyanotoxins that hold immense “pharmacological” potential against a wide array of diseases.

**Author Contributions:** **FB:** Designing, Methodology, Data analysis, Investigation, and writing original draft; **RS:** Molecular docking; **KMF:** Supervision, and investigation, **BAG:** Concept designing, and logical inputs.

**CONFLICTS OF INTEREST:** The authors declare no conflict of interest.

## REFERENCES

1. Paerl HW, Huisman J. 2009. Climate change: a catalyst for global expansion of harmful cyanobacterial blooms. *Environmental microbiology reports*. 1: 27-37.
2. O'neil J, Davis T, Burford M, Gobler C. 2012. The rise of harmful cyanobacteria blooms: the potential roles of eutrophication and climate change. *Harmful algae*. 14: 313-334.
3. Gray A, Krolikowski M, Fretwell P, Convey P, Peck LS, Mendelova M, et al. 2020. Remote sensing reveals Antarctic green snow algae as important terrestrial carbon sink. *Nat Commun*. 11: 020-16018.
4. Huang I-S, Zimba PV. 2019. Cyanobacterial bioactive metabolites—A review of their chemistry and biology. *Harmful Algae*. 86: 139-209.
5. Jones MR, Pinto E, Torres MA, Dörr F, Mazur-Marzec H, Szubert K, et al. 2021. CyanoMetDB, a comprehensive public database of secondary metabolites from cyanobacteria. *Water research*. 196: 117017.
6. Chorus I, Bartram J. 1999. Toxic cyanobacteria in water: a guide to their public health consequences, monitoring and management, pp. Ed. CRC Press.
7. Backer LC, Manassaram-Baptiste D, LePrell R, Bolton B. 2015. Cyanobacteria and algae blooms: review of health and environmental data from the harmful algal bloom-related illness surveillance system (HABISS) 2007–2011. *Toxins*. 7: 1048-1064.
8. Trevino-Garrison I, DeMent J, Ahmed FS, Haines-Lieber P, Langer T, Ménager H, et al. 2015. Human illnesses and animal deaths associated with freshwater harmful algal blooms—Kansas. *Toxins*. 7: 353-366.
9. Vidal F, Sedan D, D'Agostino D, Cavalieri ML, Mullen E, Parot Varela MM, et al. 2017. Recreational exposure during algal bloom in Carrasco Beach, Uruguay: A liver failure case report. *Toxins*. 9: 267.
10. Azeem S, Bengis R, Van Aarde R, Bastos AD. 2020. Mass die-off of African elephants in Botswana: pathogen, poison or a perfect storm? *African Journal of Wildlife Research*. 50.
11. Wang H, Xu C, Liu Y, Jeppesen E, Svenning J-C, Wu J, et al. 2021. From unusual suspect to serial killer: Cyanotoxins boosted by climate change may jeopardize African megafauna. *The Innovation*. 100092.
12. Singh RK, Tiwari SP, Rai AK, Mohapatra TM. 2011. Cyanobacteria: an emerging source for drug discovery. *The Journal of Antibiotics*. 64: 401-412.
13. Shen B. 2015. A new golden age of natural products drug discovery. *Cell*. 163: 1297-1300.
14. Harvey AL, Edrada-Ebel R, Quinn RJ. 2015. The re-emergence of natural products for drug discovery in the genomics era. *Nature reviews drug discovery*. 14: 111-129.
15. Kini S, Divyashree M, Mani MK, Mamatha BS. 2020. Algae and cyanobacteria as a source of novel bioactive compounds for biomedical applications, pp. 173-194. *Advances in cyanobacterial biology*, Ed. Elsevier,
16. Naidoo D, Roy A, Kar P, Mutanda T, Anandraj A. 2020. Cyanobacterial metabolites as promising drug leads against the Mpro and PLpro of SARS-CoV-2: An in silico analysis. *Journal of Biomolecular Structure and Dynamics*. 1-13.
17. Swain SS, Paidisetty SK, Padhy RN. 2017. Antibacterial, antifungal and antimycobacterial compounds from cyanobacteria. *Biomedicine & Pharmacotherapy*. 90: 760-776.
18. Komárek J. 2010. Modern taxonomic revision of planktic nostocacean cyanobacteria: a short review of genera. *Hydrobiologia*. 639: 231-243.
19. Komárek J. 2016. A polyphasic approach for the taxonomy of cyanobacteria: principles and applications. *European Journal of Phycology*. 51: 346-353.
20. Komárek J. 2020. Quo vadis, taxonomy of cyanobacteria (2019). *Fottea, Olomouc*. 20: 104-110.
21. Hauer T, Komárek J. 2020. CyanoDB 2.0-On-line Database of Cyanobacterial Genera. World-wide electronic publication, University of South Bohemia & Institution of Botany, Academy of Sciences of the Czech Republic. Available from: <http://www.cyanodb.cz/>(accessed 24 March 2020).

22. Guiry MD, and Guiry, G. M. 2020. 2020. AlgaeBase. World-wide electronic publication, National University of Ireland, Galway. <http://www.algaebase.org/> (accessed June 5, 2020).
23. Meriluoto JA, Eriksson JE. 1988. Rapid analysis of peptide toxins in cyanobacteria. *Journal of Chromatography A*. 438: 93-99.
24. Dell'Aversano C, Eaglesham GK, Quilliam MA. 2004. Analysis of cyanobacterial toxins by hydrophilic interaction liquid chromatography–mass spectrometry. *Journal of Chromatography A*. 1028: 155-164.
25. Rapala J, Erkomaa K, Kukkonen J, Sivonen K, Lahti K. 2002. Detection of microcystins with protein phosphatase inhibition assay, high-performance liquid chromatography–UV detection and enzyme-linked immunosorbent assay: Comparison of methods. *Analytica Chimica Acta*. 466: 213-231.
26. Spoo L, Vestervik P, Lindholm T, Meriluoto J. 2003. Screening for cyanobacterial hepatotoxins, microcystins and nodularin in environmental water samples by reversed-phase liquid chromatography–electrospray ionisation mass spectrometry. *Journal of Chromatography A*. 1020: 105-119.
27. Ruangyuttikarn W, Miksik I, Pekkoh J, Peerapornpisal Y, Deyl Z. 2004. Reversed-phase liquid chromatographic–mass spectrometric determination of microcystin-LR in cyanobacteria blooms under alkaline conditions. *Journal of Chromatography B*. 800: 315-319.
28. Fastner J, Flieger I, Neumann U. 1998. Optimised extraction of microcystins from field samples—a comparison of different solvents and procedures. *Water Research*. 32: 3177-3181.
29. Cerasino L, Meriluoto J, Bláha L, Carmeli S, Kaloudis T, Mazur-Marzec H. 2017. Extraction of cyanotoxins from cyanobacterial biomass. *Handbook of Cyanobacterial Monitoring and Cyanotoxin Analysis*. 350.
30. Daina A, Michielin O, Zoete V. 2019. SwissTargetPrediction: updated data and new features for efficient prediction of protein targets of small molecules. *Nucleic acids research*. 47: W357-W364.
31. Morris GM, Goodsell DS, Halliday RS, Huey R, Hart WE, Belew RK, et al. 1998. Automated docking using a Lamarckian genetic algorithm and an empirical binding free energy function. *Journal of computational chemistry*. 19: 1639-1662.
32. Berman HM, Westbrook J, Feng Z, Gilliland G, Bhat TN, Weissig H, et al. 2006. The protein data bank, 1999–. *International tables for Crystallography*.
33. Biovia DS. 2017. Discovery studio visualizer. San Diego, CA, USA. 936.
34. Pettersen EF, Goddard TD, Huang CC, Couch GS, Greenblatt DM, Meng EC, et al. 2004. UCSF Chimera—a visualization system for exploratory research and analysis. *Journal of computational chemistry*. 25: 1605-1612.
35. Wang X, Huang DY, Huang S-M, Huang E-S. 2005. Integrin  $\alpha\beta3$  is a coreceptor for human cytomegalovirus. *Nature medicine*. 11: 515-521.
36. Garrigues HJ, Rubinchikova YE, DiPersio CM, Rose TM. 2008. Integrin  $\alpha V\beta3$  binds to the RGD motif of glycoprotein B of Kaposi's sarcoma-associated herpesvirus and functions as an RGD-dependent entry receptor. *Journal of virology*. 82: 1570-1580.
37. Gavrilovskaya IN, Shepley M, Shaw R, Ginsberg MH, Mackow ER. 1998.  $\beta3$  integrins mediate the cellular entry of hantaviruses that cause respiratory failure. *Proceedings of the National Academy of Sciences*. 95: 7074-7079.
38. Hermann P, Armant M, Brown E, Rubio M, Ishihara H, Ulrich D, et al. 1999. The vitronectin receptor and its associated CD47 molecule mediates proinflammatory cytokine synthesis in human monocytes by interaction with soluble CD23. *The Journal of cell biology*. 144: 767-775.
39. Yan R, Vassar R. 2014. Targeting the  $\beta$  secretase BACE1 for Alzheimer's disease therapy. *The Lancet Neurology*. 13: 319-329.
40. Kim KS, Kimball SD, Misra RN, Rawlins DB, Hunt JT, Xiao H-Y, et al. 2002. Discovery of aminothiazole inhibitors of cyclin-dependent kinase 2: synthesis, X-ray crystallographic analysis, and biological activities. *Journal of medicinal chemistry*. 45: 3905-3927.
41. Wali VB, Bachawal SV, Sylvester PW. 2009. Combined treatment of  $\gamma$ -tocotrienol with statins induce mammary tumor cell cycle arrest in G1. *Experimental Biology and Medicine*. 234: 639-650.
42. Bepler G, Kusmartseva I, Sharma S, Gautam A, Cantor A, Sharma A, et al. 2006. RRM1 modulated in vitro and in vivo efficacy of gemcitabine and platinum in non-small-cell lung cancer. *Journal of Clinical Oncology*. 24: 4731-4737.

43. Metro G, Zheng Z, Fabi A, Schell M, Antoniani B, Mottolose M, et al. 2009. In situ protein expression of RRM1, ERCC1, and BRCA1 in metastatic breast cancer patients treated with gemcitabine-based chemotherapy. *Cancer investigation*. 28: 172-180.
44. Heo SJ, Jung I, Lee C-k, Kim JH, Lim SM, Moon YW, et al. 2016. A randomized phase II trial of ERCC1 and RRM1 mRNA expression-based chemotherapy versus docetaxel/carboplatin in advanced non-small cell lung cancer. *Cancer chemotherapy and pharmacology*. 77: 539-548.
45. Rehman NU, Abed RM, Hussain H, Khan HY, Khan A, Khan AL, et al. 2018. Anti-proliferative potential of cyclotetrapeptides from *Bacillus velezensis* RA5401 and their molecular docking on G-protein-coupled receptors. *Microbial pathogenesis*. 123: 419-425.
46. Sainis I, Fokas D, Vareli K, Tzakos AG, Kounnis V, Briasoulis E. 2010. Cyanobacterial cyclopeptides as lead compounds to novel targeted cancer drugs. *Marine drugs*. 8: 629-657.
47. Aaghaz S, Gohel V, Kamal A. 2019. Peptides as potential anticancer agents. *Current topics in medicinal chemistry*. 19: 1491-1511.
48. Namikoshi M, Rinehart KL, Sakai R, Stotts RR, Dahlem AM, Beasley VR, et al. 1992. Identification of 12 hepatotoxins from a Homer Lake bloom of the cyanobacteria *Microcystis aeruginosa*, *Microcystis viridis*, and *Microcystis wesenbergii*: nine new microcystins. *The Journal of organic chemistry*. 57: 866-872.
49. Puddick J. 2013. Spectroscopic investigations of oligopeptides from aquatic cyanobacteria: Characterisation of new oligopeptides, development of microcystin quantification tools and investigations into microcystin production. University of Waikato.
50. Guzmán-Guillén R, Prieto AI, Gonzalez AG, Soria-Díaz ME, Cameán AM. 2012. Cylindrospermopsin determination in water by LC-MS/MS: Optimization and validation of the method and application to real samples. *Environmental Toxicology and Chemistry*. 31: 2233-2238.
51. Burja AM, Banaigs B, Abou-Mansour E, Burgess JG, Wright PC. 2001. Marine cyanobacteria: A prolific source of natural products. *Tetrahedron*. 57: 9347-9377.
52. Jha RK, Zi-Rong X. 2004. Biomedical compounds from marine organisms. *Marine drugs*. 2: 123-146.
53. Berry JP, Gantar M, Perez MH, Berry G, Noriega FG. 2008. Cyanobacterial toxins as allelochemicals with potential applications as algacides, herbicides and insecticides. *Marine drugs*. 6: 117-146.
54. Mazur-Marzec H, Ceglowska M, Konkel R, Pyrc K. 2021. Antiviral Cyanometabolites—A Review. *Biomolecules*. 11: 474.

## **A Study of Test Anxiety in Relation to Academic Achievement of Secondary School Students**

**Sourav Talapatra**

Seacom Skills University, Bolpur, Shantiniketan, Birbhum, India

### **ABSTRACT**

Test Anxiety is a vital issue for secondary students as their academic career begins from this level. So the students are terrified to take the exam. The present study was an attempt by the researcher to assess the relation of test anxiety with academic achievement among the secondary school students. The sample consisted of 100 students of secondary level from various secondary schools of North 24 Parganas in West Bengal. The stratified random sampling technique was used for the selection of sample in the present study. The researcher has developed a self made questionnaire followed by Likert's five point scale i.e. Always, Often, Sometimes, Rare and Not at all. For the analysis of data correlation was used by the researcher in the present study. The results of the study revealed that test anxiety of the students has a negative impact on students' life when one's test anxiety increased, the academic achievement of that student decreased.

Keywords: Test Anxiety, Academic achievement, Secondary School Students.

### **INTRODUCTION**

Anxiety refers to feelings of worry, nervousness, apprehension, or fear commonly experienced by people when faced with something they view as challenging in various forms that may be a test, speaking and performing in public, a job interview, or any other stress-inducing events. Anxiety is a much more complicated phenomenon than general activation-arousal physiological state of the body.

The term "Test Anxiety" denotes a psychological condition that leads learner to feel uneasiness or apprehending unreasonable fears before, during and after examination. Most of the students feel such an anxiety before the test. A few students is so much anxious that it affects their grades badly. It is this anxiety which prevents them to be successful in their academic life, that they cannot put their best effort in the exams, though they have much knowledge and skills. It is a temporary psychological state which can be prevented if they are taken proper care to get relieved from such an anxiety and uplift their confidence to a higher level which will enable them to perform much better. It is proved that in examination the students, having test anxiety do not achieve success than the students having no anxiety. Test anxiety centres on the fear of performance in social situations due to the threat of embarrassment. When students become victim of test anxiety, then various types of psychological changes are noticed in them. The cognitive changes that can be noticed in him/her are anger, fear, frustration, cherishing negative thoughts and to compare himself/herself with others. Test anxiety occurs among the students for various reasons such as, pressure of the parents, lack of preparation, fear of failure, weak history of exams, irrelevant thoughts etc. Text anxiety leaves negative impact on the students. Test Anxiety causes an impediment on his way to progress.

There are so many types of anxieties; test-anxiety is one of them. In academic institution, test is mandatory for students to assess their academic achievement. Sometimes this type of evaluation process creates anxiety in the students. This is called Test-anxiety, excessive level of test anxiety lowers down the self-confidence levels among the students. Test-anxiety of the students at any stages of education is a common problem. It is not only hampers students' self-confidence, but also creates hindrances to reach the level of self-actualization and learning outcome. Therefore the concept and regard to self cannot be developed.

Academic achievement is an important criterion to the students since it determines higher education, professional life and other important aspects of their life. Qualification and skill of students are determined only on the basis of their Academic achievement. Therefore, Academic achievement plays a vital role in the post academic life of the students. Intelligence reading, interest, test anxiety etc. leave tremendous impact on Academic achievement.

### **REVIEW OF RELATED LITERATURE**

Ndirangu *et al.* (2008) conducted a study on "An investigation of the relationship between Test Anxiety and Academic Performance in Secondary Schools in Nyeri district, Kenya". This research suggested that the Students experience high test anxiety before they sit their examinations which can be detrimental to their academic performance and the Test anxiety may not be one of the factors that contribute significantly to poor academic performance.

Rana & Mahmood (2010) conducted a study on “*The Relationship between Test Anxiety and Academic Achievement*” This study was found that a significant negative relationship exists between test anxiety scores and students’ achievement scores. Results showed that a cognitive factor (worry) contributes more in test anxiety than affective factors (emotional). Therefore, it is concluded that test anxiety is one of the factors which are responsible for students’ underachievement and low performance but it can be managed by appropriate training of students in dealing with factors causing test anxiety.

Kashfi et al. (2011) have conducted a study on “The relationship between test anxiety and educational performance among the students at School of Health and Nutrition, Shiraz University of Medical Sciences in 2011”. This study found that no statistically significant relationship between test anxiety and educational performance and a significant relationship was observed between GPA and gender and marital status.

Roy & Ghosh (2013) have conducted a study on “Test Anxiety and Academic Performance of School Students”. This research suggested that test anxiety adversely affects the performance of the school students and female students have higher percentage in high level of test anxiety than male students.

Sehnaz (2015) has conducted a study on “A study on the Level of Test Anxiety of B.A. 2nd Semester Students of Provincialised Colleges of Nalbari Town in Relation to their Academic Achievement”. This study was found that there is a significant positive correlation between test anxiety and academic achievement of B.A. 2nd semester students of provincialised colleges of Nalbari Town.

Duraku (2016) has conducted a study on “Factors Influencing Test Anxiety among University Students”. This study revealed that undergraduate students reported significantly higher levels of test anxiety compared to graduate students. Regarding anxiety reduction factors, Masters students reported higher levels of confidence, study skills, receiving good grades, and prior information gained compared to undergraduate students.

Msayar et al. (2016) have conducted a study on “*The Relationship Between Test Anxiety and Academic Self-Regulated Learning Among Foundation Students*”. This study was found that there was no statistically significant difference between male and female in their test anxiety and also the result showed that there was a statistically significant difference between male and female in their academic self-regulated.

### **Needs and Significance of the Study**

The present study is about test anxiety of secondary school students in the district of North 24 Parganas. Test Anxiety plays an importance role for good Academic achievement of students. The present study will help teachers, parents, guide scholar & counselor to understand the test anxiety of secondary students.

### **DELIMITATIONS OF THE STUDY**

1. The study was delimited to the North 24 Parganas district of West Bengal.
2. The study covered only the students of academic achievement of class X..
3. The study covered only WBBSE students of West Bengal. But other boards students like ICSE, ISC, and CBSE etc. were not covered in this research.

### **OBJECTIVES OF THE STUDY**

To study the relation between Test Anxiety and Academic Achievement of Secondary School Students

### **HYPOTHESIS OF THE STUDY**

**H<sub>01</sub>** : There is a significant relationship between the level of Test Anxiety and Academic Achievement of the students of Secondary School students.

### **POPULATION OF THE STUDY:**

All the students of secondary schools under the West Bengal Board of Secondary Education (WBBSE) of North 24 Parganas district were the population for the present study.

### **SAMPLE OF THE STUDY:**

The researcher selected 100 secondary school students of class X in West Bengal for the sample under study. The students in the sample were from four schools of North 24 Parganas district of West Bengal, two from rural and two from urban areas. Twenty-five students each from one boy school, one girl school and two co-ed schools were taken for his present study.

### **Sampling Technique:**

The Stratified Random sampling technique has been used in the selection of the sample. The researcher selected four secondary level schools under WBBSE of the North 24 Parganas district randomly to collect reliable, valid and unbiased data.



### Data Collection Procedure and Scoring

The tool was administered upon the X<sup>th</sup> grade students of four selected secondary schools under WBBSE in North 24 Parganas district. The authority and the concerned class of each school were informed well in advance by the researcher for the purpose of collection of data. On the day of data collection, the researcher clearly and categorically explained the instruction to the students in the class regarding what to do and how to answer the 30 items of the questionnaire within the time frame. After completion of the answering by all the students, the filled in questionnaire were collected from all the students. The researcher calculated the total score on a questionnaire by computing the score against each and every item. In computing the score of each items of the questionnaire, the researcher used direct scoring method of 5-4-3-2-1 in case of positive item, and in case of negative items, reverse scoring method of 1-2-3-4-5 was used.

### Statistical Tools used for Data Analysis

Pearson correlation was used as a statistical tool to find out the relationship between test anxiety and academic achievement and conclusion was reached accordingly.

### RESULT AND DISCUSSION

**H<sub>01</sub>** : There is a significant relationship between the level of Test Anxiety and Academic Achievement of Secondary School students.

	N	df	Pearson Correlation (r)	p	Significance
Test Anxiety	100	98	- 0.328	0.001	Significant at 0.01 level
Academic Achievement					

### DISCUSSION

There is significant negative relationship ( $p < 0.000$ ) between Test Anxiety and Academic Achievement as we see from the correlation value of  $-0.328$  at 0.01 level of significance. Therefore it can be said that as the test anxiety increases, the academic achievement of the secondary school students decreases.

### CONCLUSION

From the result and discussion we can say that majority of the students experience a notable level of test anxiety before the examination which has drastic effect on his / her academic achievement. In this study, we notice that test anxiety has a negative correlation with academic achievement, meaning increase of test anxiety decreases academic achievement and vice-versa. It may be concluded that we stay in a performance based society. When students go through stress before any test, test anxiety impacts significantly on their performance. The students can be helped by teachers and parents by going through psychological treatment.

### REFERENCES

1. Akinsola, E., & Nwajei, A.D. (2013). Test Anxiety, Depression and Academic Performance: Assessment and Management Using Relaxation and Cognitive Restructuring Techniques. *Scientific Research*, 4(6A1), 18-24.
2. Balogun, A.G., Balogun, B., & Onyecho, C.V. (2017). Test Anxiety and Academic Performance among Undergraduates: The Moderating Role of Achievement Motivation. *The Spanish Journal of Psychology*, 20, e14, 1-8.
3. Duraku, Z.H. (2016). Factors Influencing Test Anxiety among University Students. *The European Journal of Social and Behavioural Sciences*, Volume XVIII (eISSN: 2301-2218).
4. Kashfi, S. M., Jeihooni, A.K., Kashfi, S.H. & Yazdankhah, M. (2011). The relationship between test anxiety and educational performance among the students at School of Health and Nutrition, University of Medical Sciences in 2011. *Journal of Contemporary Medical Education*, DOI: 10.5455/jcme.20140714054212.
5. Msayar, H., Akhmal, R., & Mardhiana, R. (2016). The Relationship Between Test Anxiety and Academic Self-Regulated Learning Among Foundation Students. *Science Journal of Education*, 4(2), 39-45.
6. Ndirangu, G.W., Mula, M.R., Kithuka, M.R., & Nassiuma, D.K. (2008). An investigation of the relationship between Test Anxiety and Academic Performance in Secondary Schools in Nyeri district, Kenya. *Global Journal of Educational Research*, 7(1&2), 1596-6224.
7. Oladipo, S.E., & Ogunbamila, A. (2013). Academic level and student's faculty as factors of test anxiety among undergraduates. *International Journal of Development and Sustainability*, 2(2), 704-710.

8. Olaitan, A.W., & Moroluyo, A.T. (2014). Contributions of Test Anxiety, Study Habits and Locus of control to Academic Performance. *British Journal of Psychology Research*, 2(1), 14-24.
9. Onyeizugbo, E.U. (2010). Self-Efficacy and test anxiety as correlates of academic performance. *International Research Journals*, 1(10), 477-480.
10. Nivenitha, P., & Nagalakshmi, K. (2016). Influence of Test Anxiety and Mindfulness on Academic Performance among Adolescents. *The International Journal of Indian Psychology*, 3(4), 66.
11. Rana, R.A., & Mahmood, N. (2010). The Relationship between Test Anxiety and Academic Achievement. *Bulletin of Education and Research*, 32(2), 63-74.
12. Rani, R. (2017). Test anxiety among school students. *International Journal of Advanced Education and Research*, 2(4), 151-154.
13. Roy, B., & Ghosh, S. (2013). Test Anxiety and Academic Performance of School Students. *International Journal of Scientific Research*, 2(1), ISSN No 2277-8179.
14. Sehnaz, B. (2015). A study on the Level of Test Anxiety of B.A. 2nd Semester Students of Provincialised Colleges of Nalbari Town in Relation to their Academic Achievement. *Research Journal of Educational Sciences*, 3(5), 10-13.
15. Stankovska, G., Dimitrovski, D., Angelkoska, S., Ibraimi, Z., & Uka, V. (2018). Emotional Intelligence, Test Anxiety and Academic Stress among University Students. *Education in Modern Society*, 16, ISBN 978-619-7326-03-1(online).

## Two Fast and Effective Instrumental Analytical Methods for Quantitative Estimation of Cilnidipine in Marketed Formulation

Pranali Mishra\*<sup>1</sup> and Parul Mehta<sup>2</sup>

<sup>1</sup>School of Pharmacy, LN University, Bhopal, India

<sup>2</sup>Ph. D. Scholar, LN University, School of Pharmacy, Kolar Road, Bhopal, MP, India

ORCID No. - 0000-0002-6040-5232

### ABSTRACT

This work aims to develop and validate a new, simple, rapid, precise UV and RP-HPLC method to estimate Cilnidipine (CLD) in Bulk and Tablet dosage forms. The solvent selected for the UV analysis was methanol. A solution of 10µg/ml was scanned in the UV region from 200-400 nm and the  $\lambda_{max}$  value determined was 242nm. Precision and accuracy were found to be of acceptable value. The LOD and LOQ were 0.1536 µg/ml and 0.4655 µg /ml for CLD. The RP-HPLC method was developed on stainless steel C18 column; 250 mm x 4.6mm x 5µ column using acetonitrile and 0.1M Sodium acetate buffer (pH 5 adjusted with 0.1% Orthophosphoric acid) in a ratio of 70:30 (V/V) as a mobile phase at flow rate maintained at 1.0 ml/min and CLD was estimation at 242 nm with PDA detector. The sample volume is 20 µL. Isocratic elution opted. The retention time of CLD was found to be 5.507 min. The responses were linear for a concentration range of 5 to 25µg/mL, and the regression coefficient value was 0.996. Both methods were validated by ICH Q2 (R1) guideline. Both are suitable for the analysis of CLD raw material and its pharmaceutical dosage form, and they can be quickly and conveniently adopted for routine quality control analysis in official and non-official testing.

Keywords: Cilnidipine, RP-HPLC, UV Spectrophotometry, drug analysis, method development, method validation, ICH Q2 (R1) guideline

### 1. INTRODUCTION

Quantitative estimation of drugs is an essential part of every stage of pharmaceutical products' lifespan. Instrumental methods have overcome the tedious and time-consuming classical methods of quantitative analysis. Instrumental methods that are fast and cost-effective are the first choice of analysts. Therefore, several methods are tried and validated for quantitative analysis of drugs. Out of these, UV spectrophotometric and high-performance chromatographic methods (HPLC) are highly used. Cilnidipine (CLD) is a new generation calcium channel blocker with vasodilating effect and is used as an antihypertensive drug. It is designed as 1,4-Dihydro-2, 6-dimethyl-4-(3-nitrophenyl)-3, 5-pyridine dicarboxylic acid 2-methoxyethyl (2E)-3-phenyl-2-propenyl ester. [1-2] The structure of CLD is shown in Figure 1. CLD is used for the treatment of hypertension. Calcium channel blockers preferably find their utility in certain cardiovascular diseases like hypertension, angina pectoris, and myocardial infarction. The present study envisages the development of UV spectrophotometric and RP-HPLC methods to estimate CLD in bulk and their marketed pharmaceutical formulation. Over the last decade, many models have been developed and implemented for the spectrophotometric and HPLC quantitative analysis of pharmaceutical preparations. Literature reveals that the determination of CLD alone or in combination with other cardiovascular drugs is reported by Spectrophotometry [3-6], HPLC [7-12], and HPTLC [13-17] are also reported. This work was designed to develop and validate fast and cost-effective UV spectrophotometric and RP-HPLC methods for the quantitative determination of CLD from its powdered active ingredient sample and marketed drug product. Moreover, to calculate its validation parameters.

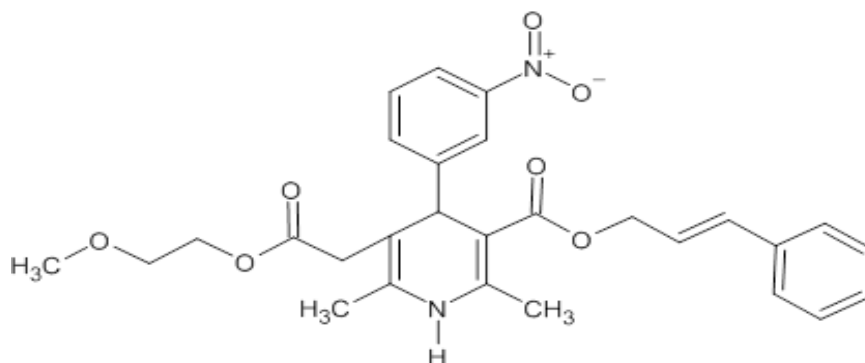


Figure 1: Chemical structure of cilnidipine

## 2. EXPERIMENTAL

### Instrument and software

**UV-Spectrophotometer:** Shimadzu PharmaSpec UV-1700 spectrophotometer (Tokyo, Japan), with preset slit width, quartz cuvette of 1 cm was used for measurements of the UV absorption. **RP-HPLC:** Chromatographic separation was performed on an HPLC (Shimadzu® - model –ISO47 Kyoto, Japan) equipped with a binary peristaltic pump and injector with a 20 µl loop volume. The system also included a PDA detector (set at 242 nm). Data were acquired and processed by using LC solutions 5.57 system control Software. Regression and statistical analysis were performed with Microsoft Excel 2010. A nylon filter of 0.45 µm was used for filtration.

**Sonicator:** A digital ultrasonic cleaner (Equitron) was used for mixing.

### 3. MATERIALS AND METHODS:

**Chemicals and Reagents:** Pure powder of CLD was supplied as a gift sample from Glenmark Pharmaceuticals Pvt. Ltd, Mumbai, India. The certified purity of CLD was 98.97%.

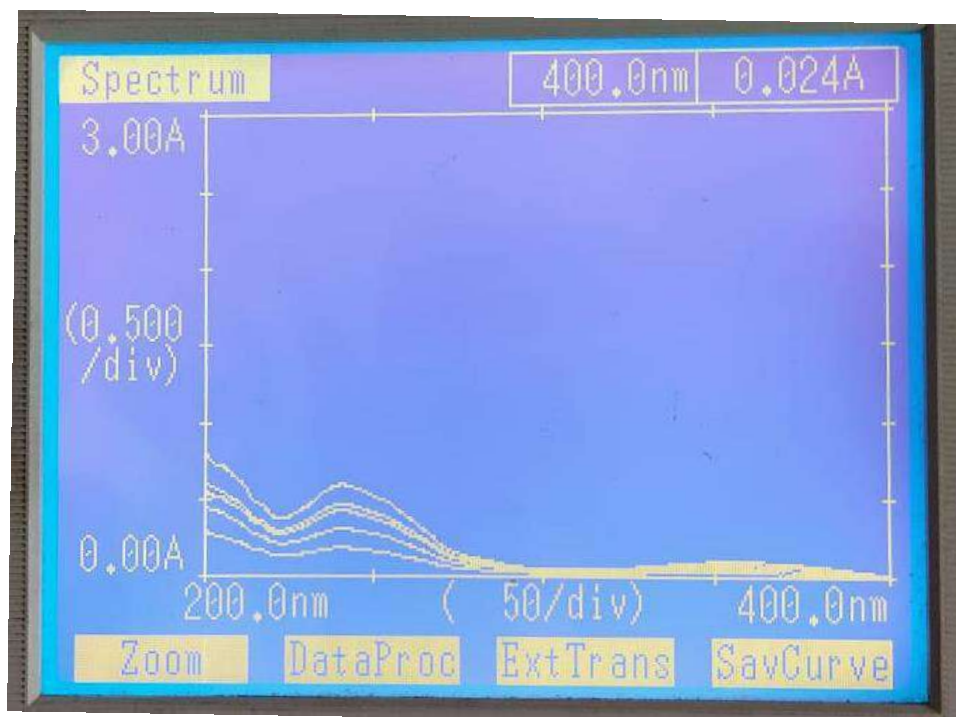
Acetonitrile (ACN) HPLC grade was purchased from Thermo fisher scientific India Pvt. Ltd., Mumbai. Methanol HPLC grade and HPLC grade water were purchased from Merck Specialties Pvt. Ltd., Mumbai, India. The solutions used to prepare standard and test solutions were prepared with methanol.

The solvents were selected based on the solubility of pure drugs and formulation in various solvents such as methanol, isopropyl alcohol, acetone, and chloroform. The drugs were freely soluble in methanol. Therefore, methanol was chosen as the solvent for UV Spectrophotometry.

CilaHeart 10 Tablets manufactured by Mankind Pharma Ltd were procured from the chemist shop.

### RECOMMENDED PROCEDURE

**Method for UV Spectroscopy:** After setting the instrument for its spectral properties, the solutions of the concentration range of 5–25 µg/mL of CLD were scanned in the wavelength ranging from 200-400 nm. [18] The wavelength of maximum absorption for CLD was found at 242 nm. [Figure 2] A Calibration curve was plotted by taking the absorption curve on the Y-axis and the concentration of CLD standard on the X-axis. [Figure3].



**Figure 2:** UV overlay spectra of the chromatograms of all five concentrations levels of cilnidipine

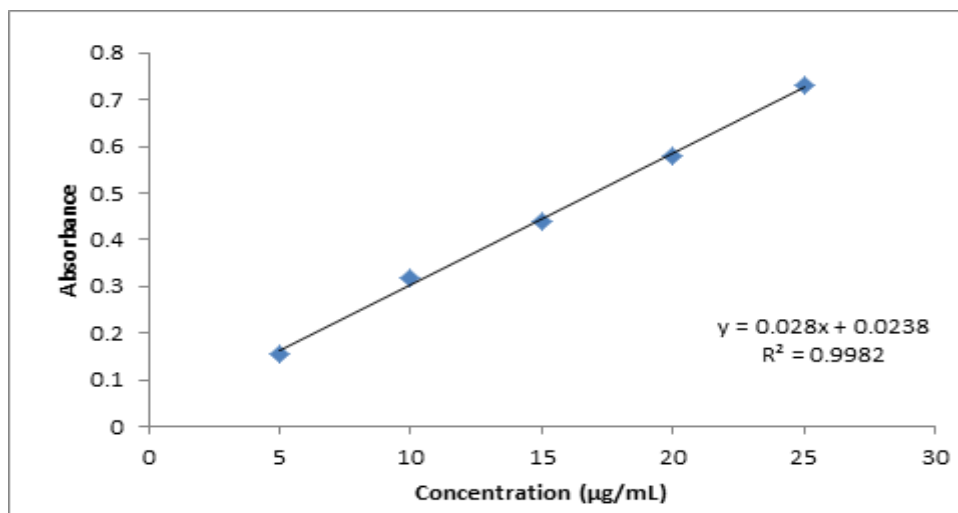


Figure 3: Calibration curve for cilnidipine for UV method

For the assay, ten tablets containing CLD were weighed and crushed. A powder equivalent to 10 mg of CLD was accurately weighed and transferred into a 10 mL clean, dry volumetric flask. The flask contents were dissolved in methanol, sonicated for 15 min, and made up to the final 10 mL volume with the same diluent. It was further diluted with the same diluents to get a concentration of 10 µg/mL finally. Further, the absorbance value of the sample was measured at 242 nm, and the % assay was calculated utilizing the average linear regression equation obtained by UV spectrophotometric method. [19]

**Selection of Detection Wavelength:** Determination of the spectral characteristics of CLD was performed by scanning UV absorbance spectra over a range between 200-400 nm using a double beam UV-Vis spectrophotometer (Shimadzu PharmaSpec UV-1700 spectrophotometer, Tokyo, Japan) against methanol as a blank, to detect absorption maxima ( $\lambda_{max}$ ), a primary stock solution of (1 mg/ml) of CLD was prepared in methanol and further diluted to obtain a working standard of (10 µg/ml). The selection of wavelength was made to extract the most informative data. [20]

#### Method-II (For RP-HPLC):

The HPLC system was stabilized for forty minutes by following the optimized chromatographic conditions to obtain a stable baseline. To check the system suitability of the method, the column was injected with one blank followed by three replicates of a single standard solution of CLD. The chromatographic run time of ten minutes was maintained for the elution of the drug from the column. The column effluents were monitored with a PDA detector at 242 nm. The chromatogram of CLD and 3D and counterplots of estimation are presented in Figures 4 and 5.[21] A Calibration curve was plotted by taking the peak area of CLD on the Y-axis, and the concentration range of 5–30 µg/mL for CLD on the X-axis is graphically presented in Figure 6.

#### ==== Shimadzu LcSolution Analysis Report ====

Sample Name : 50 cld acn 22/6  
Sample ID : 70 ACN 30 AC buffer  
Operator : Admin  
Data File Name : D:\SPINCO\Cilnidipine\ACN3.lcd  
Method File Name : D:\vns hplc Data\liso ciln 2021\cilnidipine 50.lcm  
Batch File Name :  
Report File Name : Data report format\_240120.lcr  
Acquisition Date : 21/06/22 1:11:49 PM  
Modified Date : 21/06/22 1:29:06 PM

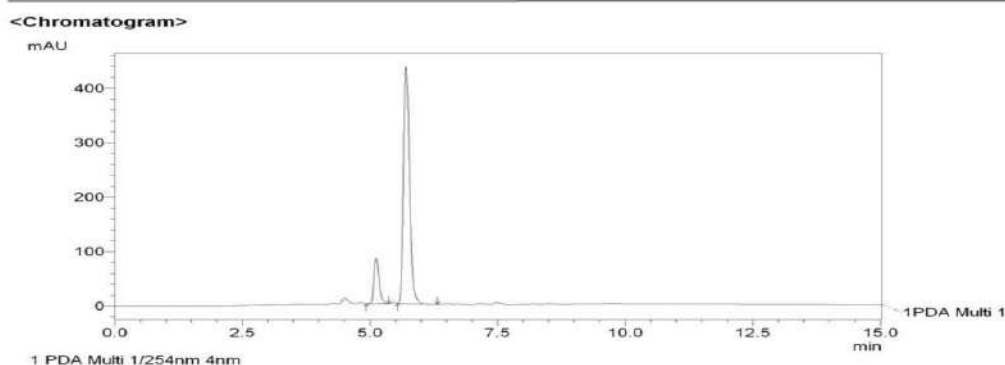


Figure 4: Chromatogram of cilnidipine

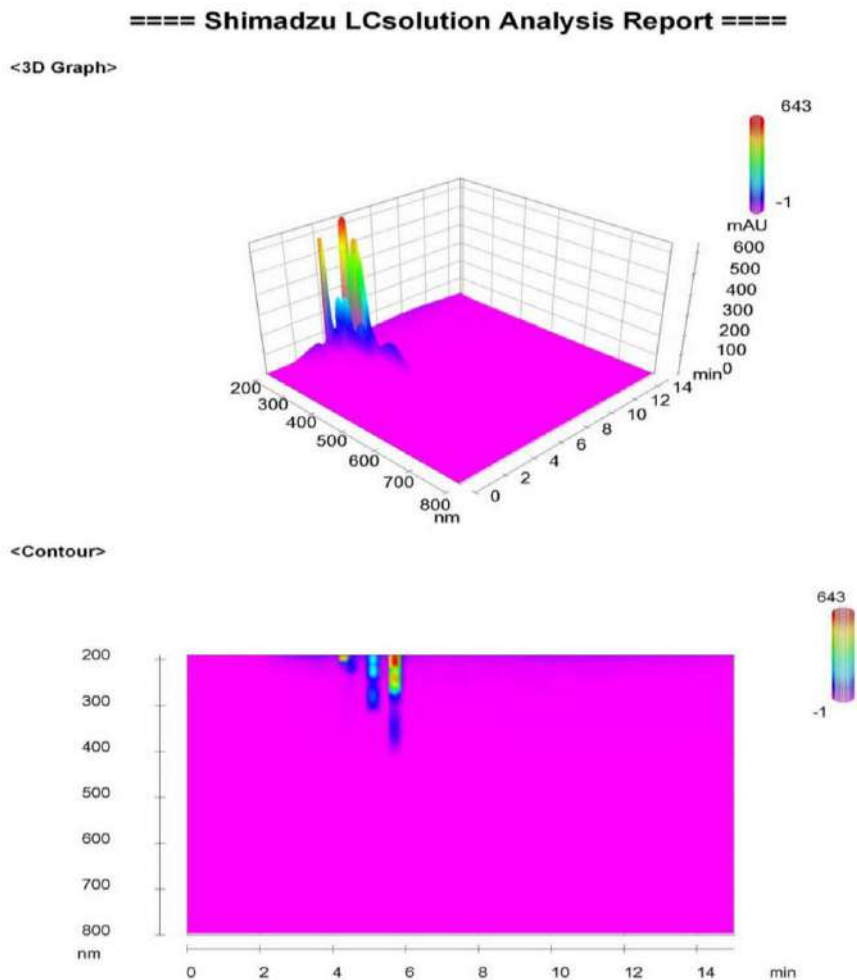


Figure 5: 3D graph and counter graph of cilnidipine analysis

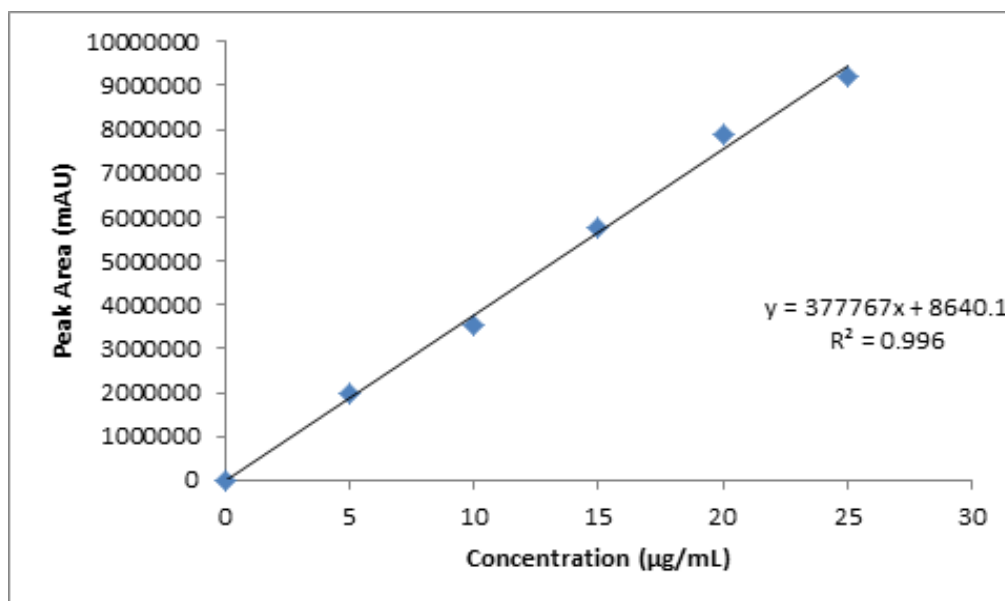


FIG. 6: Calibration plot of cilnidipine for HPLC

For the assay, ten tablets containing CLD were weighed and crushed. A powder equivalent to 10 mg of CLD was accurately weighed and transferred into a 10 mL clean, dry volumetric flask. The flask contents were dissolved in HPLC grade methanol, sonicated for 15 min, filtered through Whatman filter paper number 41, and made up to the final 10 mL volume with the same diluent. It was further diluted with the same diluents to get the concentration of 10µg/mL finally and measured the absorbance at 242 nm. The standard graph was used to find the tablet drug content against the label claim.

### **Method Development and Optimization of Chromatographic Conditions:**

**Column Selection:** Chromatographic separation was performed using Pharmaspec stainless steel C18 column (5 $\mu$ , 250X4.6mm). All investigated runs were performed in isocratic elution mode.

**Flow Rate:** The flow rate was adjusted to 1 mL/min.

### **Preparation of Mobile Phase:**

#### **Preparation of Sodium Acetate Buffer 0.1M**

1.36 g of sodium acetate was accurately transferred to a 1000 mL volumetric flask, and about 900 mL of HPLC grade water was added. The solution was degassed by sonication and then brought up to the volume (1000 mL) with water. The pH =3 was adjusted with 0.1% OPA.

**0.1% OPA** - 0.1 mL of orthophosphoric acid was accurately transferred into a 100 mL volumetric flask and added to about 90 mL of water. The solution was degassed by sonication and then brought up to the volume (1000 mL) with water.

**Preparation of Stock and Working Standard Solution:** Standard stock solution of CLD was prepared by accurately weighing 10 mg of pure CLD and dissolving in 50 mL of methanol into a 100 mL volumetric flask. Solutions were further sonicated for about 15 min after that, diluted with the same solvent to obtain a 100  $\mu$ g/mL concentration of drugs for UV spectroscopy and HPLC method. To construct the calibration curves, the solutions were carefully diluted to obtain a 5–25  $\mu$ g/mL concentration range for CLD. [22]

### **Method Development Optimization:**

For selecting the Mobile Phase during method development, different mobile phases were tried to achieve the best analytical method for the determination of CLD. It was based on the polarity of the sample, availability of the solvents, proper retention time (Rt), the sensitivity of the assay, and a short run time of the sample.[23] The mobile phase used for this study was ACN (organic phase) and 0.01 M Sodium acetate (PH=5) adjusted with 1% of OPA (aqueous phase) by isocratic mode. The flow rate of 1 mL/min was found to be satisfactory. The detection was carried out at 242 nm with a PDA detector. The Rt of CLD was 5.507 min. The optimized chromatogram and optimized conditions for estimation of CLD by the proposed RP-HPLC method are mentioned in Fig. 4 and Table 4.

### **Analytical Method Validation**

In accordance with ICH Q2 (R1) guidelines, the developed RP-HPLC method was validated for the parameters like system suitability, linearity, accuracy, precision, robustness, ruggedness, and the limit of detection (LOD) and limit of quantitation (LOQ).[24]

#### **System Suitability**

To evaluate the system suitability of a chromatographic procedure, the acceptable system suitability limits are RSD < 1%, Theoretical plates > 2000, tailing factor < 1.5 and Asymmetry factor < 2. The chromatographic system utilized for analysis must pass with these typical values before commencing sample analysis. Initially, the HPLC system was stabilized for forty minutes by following the optimized chromatographic conditions. To check the system suitability of the method, a column was injected with one blank followed by three replicates of a single standard solution of CLD, and chromatograms were recorded to evaluate the system suitability parameters. [25]

#### **Calibration Curve (Linearity).**

Accurately measured working sub stock solution of CLD (0.5, 1.0, 1.5, 2.0, 2.5, and 3.0mL) were transferred to a series of 10 mL volumetric flask and diluted up to the mark with methanol. The absorbance of solutions at the  $\lambda_{max}$  was collected. Method linearity was assessed by linear regression analysis using the least square method for the average point of three authentic calibration curves at 5-25 $\mu$ g/mL concentrations. The linear regression analysis was performed on the selected wavelength. [26]

#### **Method Precision (Intraday and Interday)**

The method precision was assessed on two levels 'repeatability and intermediate precision. The method was tested for these two precision levels based on six determinations of 10  $\mu$ g/mL of CLD at diverse time intervals on the same day (intra-day precision) and three dissimilar days (inter-day precision). The standard deviation and %RSD for the intra-day and inter-day precision were determined. Intermediate precision was performed Intraday and Interday at 100% of test concentration. [27]

#### **Accuracy (% Recovery)**

Accuracy was performed using the standard addition method at three levels of 80%, 100%, and 120% of test concentration, and the percentage recovery from the spiked solution was determined. [28]

#### 2.7.4. Limit of detection (LOD) and limit of quantification (LOQ)

The standard deviation approach has been used to determine the LOD and LOQ as per ICH guidelines. Limit of determination and quantification shows the sensitivity of the analytical methods, which were performed according to the following Equation:

$$LOD = 3.3 \frac{\sigma}{m}$$

$$LOQ = 10 \frac{\sigma}{m}$$

Where  $\sigma$  symbolizes the standard deviation of the y-intercepts of the regression line, and m is the mean slope of the calibration curves. [29]

#### Robustness

The proposed method can be subjected to robustness studies by introducing small, deliberate changes in experimental parameters such as a change in flow rate  $\pm 0.2$  mL/min, change of mobile phase composition  $\pm 2\%$ , and change of buffer solution PH  $\pm 0.2$ . [30]

### RESULTS AND DISCUSSION

#### Uv - Spectrophotometric Method

The ultraviolet overlay spectra of all five concentrations levels of CLD depicted  $\lambda_{\max}$  242 nm (Figure 2). As per the Beer's Law, good linearity was achieved in 5- 25  $\mu\text{g/mL}$ . (Figure 3) Further, the intercepts of the calibration curves were not significant. Results of the intra-day and inter-day accuracy and precision were determined by analyzing in triplicate 10  $\mu\text{g/mL}$  of CLD. Repeated and intermediate precision were evaluated, and percent relative standard deviation (%RSD) values were calculated. The % RSD of the intraday and interday precision for the UV method was 0.426 and 0.581, respectively, indicating good precision (Table 2). Accuracy represented as percent recovery was good for the proposed method in 99.19-99.55 (Table 3). The LOD and LOQ were 0.1536  $\mu\text{g/ml}$  and 0.4655  $\mu\text{g/ml}$  for CLD at 242 nm. The computed LOD and LOQ were also represented in Table 1. Lastly, the validated method finds application for quantitative analysis of CLD (Cilaheart 10) marketed pharmaceutical dosage form. Ten tablets were weighed and crushed. A powder equivalent to 10 mg of Cilnidipine was accurately weighed and transferred into a 10 mL clean, dry volumetric flask. The flask contents were dissolved in methanol as solvent, sonicated for 15 min, and made up to the final 10 mL volume with methanol. The stock solution was appropriately diluted to get a solution of concentration 10 $\mu\text{g/mL}$ . The absorbance value of the sample was measured at 242 nm. The % assay was calculated using the UV spectrophotometric method's average linear regression equation.

**Table 1:** Optical characteristics, regression data analysis of the proposed method for cilnidipine

Parameter	Method-I (UV)	Method-II (RP-HPLC)
$\lambda_{\max}$ (nm)	242 nm	242 nm
Beer's law limits ( $\mu\text{g/mL}$ )	5-25	5-25
Regression equation ( $y = mx + C$ )	$y = 0.028x + 0.0238$	$y = 377767x + 8640.1$
Slope (m)	0.028	377767
Intercept (c)	0.0238	8640.1
Standard deviation of intercept (Sa)	0.0018	17.4737
Standard deviation of slope	0.000115	1998.535
Correlation coefficient (r)	0.9982	0.996
Limit of detection (LOD $\mu\text{g/L}$ )	0.153635	0.07616
Limit of quantification (LOQ $\mu\text{g/L}$ )	0.465559	2.3079

**Table 2:** Intraday and interday precision study

Precision	UV Spectrophotometry		HPLC	
	% Estimation of CLD $\pm$ SD (n = 6)	%RSD	% Estimation of CLD $\pm$ SD (n = 6)	%RSD
Intraday precision	99.69 $\pm$ 0.463	0.426	99.46 $\pm$ 0.645	0.754
Interday precision	99.79 $\pm$ 0.277	0.581	99.55 $\pm$ 0.238	0.687



**Table 3:** Results of recovery studies of cilnidipine by UV Spectrophotometry

Drug	Levels %	Conc. taken ( $\mu\text{g/mL}$ )	Amount added ( $\mu\text{g/mL}$ )	Amount found ( $\mu\text{g/mL}$ )	Amount of std drug recovered ( $\mu\text{g/mL}$ )	% Recovery $\pm$ SD ( $n = 3$ )
CLD	80		8	18.98	18.85	99.31 $\pm$ 0.075
	100	10	10	20	19.91	99.55 $\pm$ 0.036
	120		1.2	11.2	11.11	99.19 $\pm$ 0.051

**For Hplc Method:** Initial optimization consisted of selecting wavelengths, the mobile phase composition, stationary phase, and flow rate. Table 4 also identified reproducibility results, good peak shape, minimal tailing, and short runtime. After evaluating these parameters, the drug's retention behavior was studied concerning the pH of buffer solution in the range of 3.0–7.0 and the composition of the mobile phase. The buffer solution of pH 5.0 and mobile phase composition of acetonitrile: buffer (70:30) was found most appropriate for pharmaceutical analysis on Pharma spec stainless steel C18- column. The flow rate was optimized based on capacity factors and column efficiency. CLD was well resolved in a reasonable time of about 15 minutes. The  $R_t$  was 5.507min. Figure 4 shows the standard chromatograms of CLD at optimized HPLC conditions. The wavelength of 242 nm was selected for the UV detection because, at this wavelength, there was maximum absorbance of CLD. Other analysts in various literature show similar results.[24-30]

**Table 4:** Optimized chromatographic conditions

Parameter	HPLC method
Column	Shimadzu® C18 column model–ISO47 Kyoto, Japan, (4.6 mm i.d. $\times$ 250 mm, 5 $\mu$ particle size)
Mobile phase	Acetonitrile: Buffer (70: 30 v/v)
Flow rate (mL/min)	1
Diluent	Methanol
Run time (min)	15 min
Column temperature ( $^{\circ}\text{C}$ )	Ambient
The volume of injection loop ( $\mu\text{L}$ )	20
Detection Wavelength (nm)	By PDA at 242 nm
Retention time (min.) $\pm$ SD*	5.067 $\pm$ 0.0012

To ascertain the effectiveness of the system suitability test, three replicate injections of freshly prepared working standard solution were injected, peak area and RSD were calculated, and data were presented in table - 5. The calibration curve was constructed by plotting concentrations on the x-axis and peak area on the y-axis (Figure 6). The method of linear regression was used for data evaluation. It was linear in the 5-25 $\mu\text{g/mL}$  concentration range with a good correlation coefficient of  $r^2 = 0.996$ . The number of theoretical plates of the CLD peak was 9452.294. For intra-day, solutions were analyzed in one day, and for inter-day, similar solutions were evaluated for three consecutive days. Results of the intra-day and inter-day accuracy and precision were determined by analyzing in triplicate 10  $\mu\text{g/mL}$  of CLD. The results are presented in Table 2. The % RSD of the intraday and interday precision for the HPLC method was 0.754 and 0.687, respectively. To confirm the accuracy of the proposed method, recovery experiments were carried out by standard addition technique. Three different levels of standards were added to the targeted concentration in triplicate. The mean percentage recovery of CLD was found to be 99.36%. The results are shown in Table 6, which indicates that the method is accurate and precise. Accuracy represented as percent recovery was found to be suitable for the proposed method in the range of 98.88-99.15% with % RSD < 2, the result shows that the developed method was accurate. Results are comparable with the same presented in various literature. [24-30]

**Table 5:** System Suitability Parameter of developed HPLC method

SST	Observed Value	RSD
Retention Time	5.067 $\pm$ 0.015	0.147
Theoretical plates (n)	9452.294 $\pm$ 19.99	1.56
Peak area $\pm$ SD	3515794 $\pm$ 2711.2	0.79
Tailing Factor	1.07 $\pm$ 0.02	0.42

RSD = relative standard deviation, n = Average of 3 determinations, SST = System suitability test

**Table 6:** Accuracy of cilnidipine by HPLC

Level (%) (n=3)	Target Conc. (µg/mL)	Spiked Conc. (µg/mL)	Total Conc. (µg/mL)	Area	Found conc. (µg/mL)	% Recovery	Mean of % recovery ± RSD
50	10	15	25	9222677	24.68	98.72	98.88± 0.1833
	10	15	25	9222966	24.71	98.84	
	10	15	25	9211548	24.77	99.08	
100	10	20	30	10897941	29.44	98.13	98.75± 0.546168
	10	20	30	10896852	29.75	99.16	
	10	20	30	10854587	29.69	98.96	
150	10	25	35	12395512	34.92	99.77	99.15± 0.858604
	10	25	35	12401769	34.36	98.17	
	10	25	35	123073690	34.83	99.51	

RSD is relative standard deviation, 'n' is the number of determinations

The proposed method was subjected to robustness studies concerning parameters such as, change in flow rate to  $1.0 \pm 0.2$  mL, mobile phase composition changes to 70:30 v/v  $\pm 2\%$ , and PH change of buffer solution  $5 \pm 0.2$  (Table 7). The obtained value of RSD < 2 indicates that the method was found robust concerning variability in the above conditions. The LOD and LOQ were  $0.07616 \mu\text{g/mL}$  and  $2.3079 \mu\text{g/mL}$ . Thus, this method was susceptible as they were within the permitted limits. Ultimately the method was examined for quantification of marketed formulations. The content of actives found in the commercial brand of tablets (Cilaheart 10, Mankind Pharma Ltd) is shown in Table 8. The low values of RSD indicate that method is precise. The % assay value for Cilaheart 10 was  $99.80 \pm 0.067$ , and the obtained results are shown in Table 8. The sample solution injected after 24 h of preparation did not show any appreciable change in the assay. It shows that this method can be successfully applied to estimate CLD.

**Table 7:** Result of change in Flow rate; pH of the buffer, and % mobile phase

		Mean area ± SD	RSD
Flow Rate $\pm 0.1$ mL/min	0.9	10877941±7543	0.069
	1	10896852±6985	0.452
	1.1	10904587±7590	0.041
PH of Buffer $\pm 0.2$	4.8	1075894±6994	0.104
	5	10896852±6985	0.051
	5.2	1083235±7043	0.254
Mobile phase composition $\pm 2\%$	68 :32	1025469±5968	0.039
	70:30	10896852±6985	0.348
	72:28	1120101±5487	0.053

**Table 8:** Assay results for cilnidipine in tablet dosage form

Pharmaceutical dosage form	Labeled claim (mg)	% Content of drug $\pm$ SD*	
		HPLC method	UV method
Cilaheart 10 tablet	10 mg	$99.80 \pm 0.067$	$99.93 \pm 0.030$

\* Each value is mean  $\pm$  deviation of six determinations

## CONCLUSION

The proposed UV spectrophotometric method and the HPLC method for estimating CLD in pharmaceutical formulations were found to be simple, fast, precise, accurate, and robust. Both the methods were validated and showed satisfactory results. The developed UV method has advantages like economic due to the cost of working and instrumentation; it also has the advantage of less time to prepare standard and sample solutions. Developed HPLC methods have the advantage of chromatographic separation of interfering excipients. Hence, both methods have advantages and are suitable for analyzing CLD raw material and its pharmaceutical dosage form. Hence it can be quickly and conveniently adopted for the routine quality control analysis for assay and dissolution and content uniformity, and other official and non-official testing.

## ACKNOWLEDGEMENT

The authors would like to thank Glenmark Pharmaceuticals Pvt. Ltd, Mumbai, India, for providing the samples of Cilnidipine. We are highly grateful to the School of Pharmacy, LN University, Bhopal, and Dr. Vipin Dhote,

Principal, VNS Faculty of Pharmacy, Bhopal, for providing the necessary facilities to carry out this research work.

**CONFLICT OF INTEREST:** Nil

#### REFERENCES

1. Indian Pharmacopoeia; Indian Pharmacopoeia Commission; Ministry of Health & Family Welfare, Government of India: Ghaziabad, India, 2018, vol. 2.Pg 1392-1393; 1616-1618.
2. Japanese Pharmacopoeia; Society of Japanese Pharmacopoeia. Tokyo, Cilnidipine 2016; P.704–705.
3. Hinge MA, Desai DK, Patel ES, Singh R, Chavda R, Patel D. Development and validation of UV spectrophotometric method for simultaneous estimation of cilnidipine and metoprolol succinate in bulk drugs and combined dosage form. *Der Pharmacia Lettre*. 2015;7: 299-306.
4. Agrawal O, Bansod T Simultaneous Estimation of Cilnidipine and Metoprolol Succinate by UV-Spectrophotometric and RP-HPLC Method in Bulk and Solid Dosage Inventi Impact: Pharm Analysis and Quality Assurance. 2016;4: 196-204
5. Chaudhari VG, Vekaria HJ, Parmar AR. Development and Validation of Q-Absorbance Ratio Method for Simultaneous Estimation of Cilnidipine and Metoprolol Succinate In Their Combined Dosage Form. *Inventi Rapid: Pharm Analysis & Quality Assurance*. 2014;2:
6. Shirodkar, P. Development and Validation of Absorbance Correction Method for Simultaneous Estimation of Bisoprolol Fumarate and Cilnidipine in Tablet Dosage Form. *Indian Drugs* 2018.
7. Kachave RN, Kale M, Wagh RD. Simultaneous estimation of Cilnidipine and Valsartan by RP-HPLC in tablet formulation. *Eurasian J. Anal. Chem* 2016; 11(5):245-53. doi: 10.12973/ejac.2016.137a
8. Patel H, Damahe DP, Narkhede SB. RP-HPLC Method Development and Validation for Simultaneous Estimation of Cilnidipine and Bisoprolol Fumarate in Tablet Dosage Form *International Journal of Chem Tech Research* 2019;12(1): 269-276.
9. Pawar P, Gandhi SV, Deshpande PB, Padmanabh B, Vanjari S, Shelar SU. Simultaneous RP-HPLC estimation of Cilnidipine and Telmisartan in combined tablet dosage form. *Chem. Sin.* 2013; 4(2):6-10.
10. Masada S, Tsuji G, Arai R, Uchiyama N, Demizu Y, Tsutsumi T, et al. Rapid and efficient high-performance liquid chromatography analysis of N-nitrosodimethylamine impurity in Valsartan drug substance and its products. *Sci. Rep.* 2019; 9(1):1-6.
11. Siddiqui MI, srinivas M. Simultaneous estimation of Telmisartan and Cilnidipine in bulk and in tablet formulation using RP-HPLC. *PHARMANEST* 2014; 5(3):2142-2148.
12. Kharat SS, Andhale SP, Saudagar RA. Validated RP-HPLC Method for Determination of Cilnidipine in Bulk and Pharmaceutical Dosage Form *World J. Pharm. Pharm. Sci.* 6(3): 1184-1195.
13. Shah DM, Doshi DB. Development and validation of HPTLC method for simultaneous estimation of nebivolol hydrochloride and cilnidipine in combined pharmaceutical tablet dosage form. *Int J Pharma Res Rev* 2016;5(6):1-7.
14. Karmalkar HS, Vaidya VV, Gomes NA, Choukekar MP, Kekare MB. Determination of cilnidipine from pharmaceutical formulation by high performance thin layer chromatographic method. *Analytical chemistry*. 2008;7(8):573-576.
15. Minase AS, Dole MN. Development and Validation of Analytical Method for Simultaneous Estimation of Cilnidipine and Olmesartan Medoxomil in Bulk and Tablet Dosage form by HPTLC. *Journal of Advanced scientific Research*, 2014; 5: 34-38.
16. Dedhiya PP, Patel CJ, Chauhan RS, Kalyankar GG, Vyas RH, Shah SA. Development and validation of HPTLC method for simultaneous estimation of Olmesartan medoxomil and Cilnidipine in their combined pharmaceutical dosage forms. *Journal of Pharmacy and Applied Sciences* 2015;2(2):21-27.
17. Soni V, Kakadiya J, Patel P, Shah N. Development and Validation of High Performance Thin Layer Chromatographic method for Cilnidipine and Metoprolol Succinate in their combined pharmaceutical dosage form. *Int J Pharma Nano Sci.* 2014;61: 61–72.

18. Jain S, Jain S, Mishra A, Garg G, Modi RK. Formulation and characterization of fast disintegrating tablets containing Cefdinir solid dispersion. *International Journal of Pharmacy & Life Sciences*. 2012 Dec 1;3(12).
19. Mishra A, Yadav SK. Development of sustained release metoprolol succinate matrix tablets using kappa carrageenan as monolithic polymer. *Research Journal of Pharmacy and Technology*. 2016 Sep 1;9(9):1311.
20. Pandey S, Pandey AN, Mishra A, Kawadkar M. Development and characterization of valsartan and hydrochlorothiazide film coated tablet. *International Journal of Pharmacy & Life Sciences*. 2011 Jul 1;2(7).
21. Dewangan HK, Sharma A, Mishra A, Singour P. Mucoadhesive microspheres of atorvastatin calcium: rational design, evaluation and enhancement of bioavailability. *Ind J Pharma Educ Research*, 2021, 55(3-S); S733-S741.
22. Mishra A, Chaturvedi P, Mishra P, Sudheesh MS. Comparative Evaluation of Amorphous Polymers in Solubility and Bioavailability Enhancement. – *European Journal of Parenteral and Pharmaceutical Sciences*, 2021, 26 (2); 1-17.
23. Bhamare P, Umadoss P, Upmanyu N, Dubey R. Identification, isolation, structural characterisation, synthesis and in silico toxicity prediction of the alkaline hydrolytic degradation product of brivaracetam by using LC-PDA, preparative HPLC, LC/HESI/LTQ, FTIR, and <sup>1</sup>H NMR. *Analytical Methods*. 2020;12(14):1868-81.
24. Hiyama Y. ICH Quality Guidelines, topic Q2(R2)/Q14: validation of analytical procedure: text and methodology, March 2022, available from [https://database.ich.org/sites/default/files/ICH\\_Q2-R2\\_Document\\_Step2\\_Guideline\\_2022\\_0324.pdf](https://database.ich.org/sites/default/files/ICH_Q2-R2_Document_Step2_Guideline_2022_0324.pdf) accessed on 25 June 2022.
25. Bose A. HPLC calibration process parameters in terms of system suitability test. *Austin Chromatogr*. 2014;1(2):1-4.
26. Al-Hakkani, MF, Gouda GA, Hassan SH, Farghaly OA, Mohamed MM. Fully investigation of RP-HPLC analytical method validation parameters for determination of Cefixime traces in the different pharmaceutical dosage forms and urine analysis. *Acta Pharmaceutica Scientia*, 2021; 59(1).
27. Milla P, Ferrari F, Muntoni E, Sartori M, Ronco C, Arpicco S. Validation of a simple and economic HPLC-UV method for the simultaneous determination of vancomycin, meropenem, piperacillin and tazobactam in plasma samples. *Journal of Chromatography B*. 2020; 1148: 122151.
28. Sun Z, Lu Y, Zhu L, Liu W, Qu Y, Lin N, Yu P. Simultaneous separation, concentration and determination of trace fluoroquinolone antibiotics in environmental samples using a polymer aqueous two-phase system coupled with HPLC. *Journal of Chemical Technology & Biotechnology*. 2019 Sep;94(9):2917-27.
29. Alquadeib BT. Development and validation of a new HPLC analytical method for the determination of diclofenac in tablets. *Saudi pharmaceutical journal*. 2019 Jan 1;27(1):66-70.
30. Dejaegher B, Vander Heyden Y. Ruggedness and robustness testing. *Journal of chromatography A*. 2007 Jul 27;1158(1-2):138-57.

## Heavy Metal Distribution and Contamination in Surface Water of Vellar Estuary, Southeast Coast of India

N. Jakeer<sup>1\*</sup>, S. Arunadevi<sup>2</sup> and R. Sivasamandy<sup>3</sup>

<sup>1,2</sup>PG and Research Department of Chemistry, Urumu Dhanalakshmi College (Affiliated to Bharathidasan University), Tiruchirappalli- 620019, India

<sup>3</sup>Department of Civil Engineering, Periyar Maniyammai Institute of Science and Technology, Vallam, Thanjavur, India

### ABSTRACT

In this study, measured the distribution of heavy metals (Cd, Cr, Cu, Fe, Ni, Pb, Zn) in the surface water of Vellar estuary, Southeast Coast of India. The concentration of heavy metals was measured by atomic absorption spectroscopy (AAS) instrument. Heavy metals concentrations were found to decrease in sequence of Fe > Cu > Pb > Zn > Cd > Cr > Ni. Results showed that heavy metal concentrations in the marine surface water generally exceed the criteria of international marine water quality. Moreover, both the contamination factor (CF) and pollution load index (PLI) values suggested the elevation of heavy metals concentration in the region. The results revealed that the heavy metal concentration was higher during Post-monsoon season in water of the year 2020 and the order of concentration Fe > Zn > Cu > Cd > Pb > Cr > Ni. As a result, the purpose of this research was to find out what other heavy metals (Pb, Cd, Cr, and Zn) were in the water.

Keywords: Heavy metals, AAS, CF, HPI, PLI, Marine Surface Water.

### 1. INTRODUCTION

Heavy metal concentrations in estuaries, rivers, and lakes, as well as the methods through which they are transported into the systems, have peaked researchers' attention in recent years. Heavy metals may enter aquatic systems from different natural and anthropogenic sources including industrial or domestic wastewater, application of pesticides and inorganic fertilizers, storm runoff, leaching from landfills, shipping and harbour activities, geological weathering of the earth crust and atmospheric deposition (Yilmaz F., et al., 2007). Metals have been utilised since the origin of civilisation, but with the remarkable rise of industries, their use has increased significantly. The rising use of metals has resulted in extensive environmental pollution. Industrialization, population growth and technological developments in recent years have led to a huge increase and accretion of heavy metals in the environment (Liu et al., 2009). Heavy metals enter the environment through various means, including the weathering of rocks and soil, the discharge of urban and industrial waste into water bodies and anthropogenic activities (Alkarkhi et al., 2008). Measurement of heavy metals in water samples can show the condition of the ecosystem regard to heavy metal pollution (Saghali, M. et al., 2014). Furthermore, nutrients commonly found in aquatic ecosystems, including phosphorus, nitrogen, and organic matter, have been reported to affect the geochemical behaviour of heavy metals (Liu et al., 2019a; Miranda et al., 2021). Recently, contamination of water with heavy metals is a major environmental concern; various anthropogenic activities continuously increase the amount of heavy metals in the water bodies especially in the estuary and river. Heavy metals including both essential and non-essential elements have ecotoxicological effect to the living organism (Storelli et al., 2015).

### 2. MATERIALS AND METHODS

#### 2.1. Description of the Study Area

In this regard, the present study area (Fig.1.) has gained significance as the Vellar estuary is intensively studied for the first time with regard to it and is also the first study of its kind in India to conduct a long-term (two-year) seasonal investigation on this area. The Vellar river commences from the Shervarayan hills of Salem district in Tamil Nadu, India, navigating approximately 480 km before forming an estuary at Parangipettai (lat. 11° 30' N, long. 79° 46' E) where it culminates into the Bay of Bengal. The estuarine banks are composed of clay, black clay, alluvium and silt, and the estuary is also influenced by these sediments. These soils make the Vellar estuary one of the most fertile estuaries of Tamil Nadu. The annual rainfall in these areas is about 373.3 mm, which has been found to be good for healthy agriculture. Besides agriculture, there are several aquaculture farms in and around Parangipettai on the banks of the Vellar estuary. The Vellar estuary is a true estuary as it remains open throughout the year. At Parangipettai, the estuary is about 600 m wide and 2.5 m deep, while the tidal influence stretches up to 15 km upstream. Various anthropogenic activities such as inhabitation, agriculture, aquaculture, boating and fishing activities may yield pollutants that are deposited in the estuary. The

northeast monsoon compounds the problem of pollutants since it brings more terrestrial wastes along with freshwater.

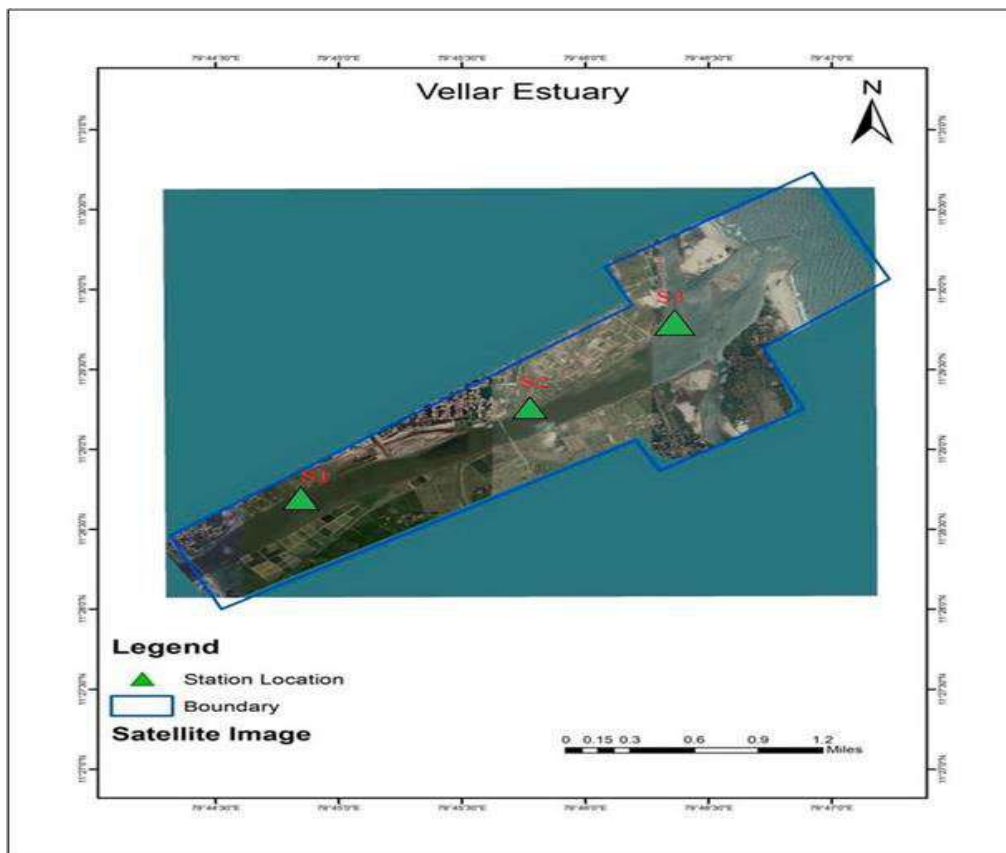


Fig.1. Map showing sampling location of the study area

## 2.2. Sample Analysis

Surface water and sediment samples were collected during the various seasons for the period 2019–2021. The various seasons include winter, summer, southwest monsoon and northeast monsoon for the periods 2019–2021. The collection spots are exhibited in Fig. 1. Heavy metal concentrations were determined using atomic absorption spectrometry (Perkin-Elmer, 3300/96, MHS-10) with a specific lamp for each particular metal. The heavy metal concentrations Pb, Cd, Fe, Zn, Mn and Cu were analysed by flame atomic absorption spectrometry. Arsenic and mercury were determined by atomic absorption spectrometry with hydride / cold vapor generation. Lead was determined by atomic absorption spectrometry in a graphite furnace. The following wavelengths were used: Pb (283.3 nm), Cd (228.8 nm), Fe (248.3 nm), Zn (213.9 nm), Mn (279.5 nm), Cu (324.8 nm), As (193.7 nm) and Hg (253.7 nm). The detection limits for trace elements and metalloids Mn, Fe, Cu, Zn, As, Cd, Pb and Hg are respectively 0.0002, 0.001, 0.0006, 0.002, 0.005, 0.0003 and 0.0001 mg kg<sup>-1</sup>. The quality of the analytical data has been ensured through the implementation of quality assurance and laboratory quality control methods, including the use of standard operating procedures, calibration with standards, blank analysis reagents, recovery of known additions and replica analysis. All analyses were performed in triplicate and the results were expressed as an average. In order to minimize the variability among the sample results, we used the same analytical laboratory and this laboratory applied the same method of analysis for each chemical element searched during the study period.

## 3. RESULTS AND DISCUSSION

### 3.1. Distribution of Heavy Metals

Heavy Metals are released to the water column through sediment resuspension, adsorption-desorption, reduction-oxidation reactions, and the action of degrading organisms (Barakat *et al.*, 2012). The content of Fe in the surface water ranged from 0.85 to 1.38 ppm and while Cd, Cr, Cu, Ni, Pb and Zn and ranged from 0.090 to 0.180 (Cd), 0.03 to 0.125 (Cr), 0.147 to 0.317 (Cu), 0.06 to 0.075 (Ni), 0.08 to 0.109 (Pb) and 0.547 to 0.873 (Zn). (Table.1) Whereas maximum limits of these metals permissible in drinking water recommended by WHO/FEPA are 0.03 µg/L, 0.050 µg/L, 0.16 µg/L, 1.0 µg/L, and 0.003 µg/L, respectively (World Health Organization, 2003). So it can be suggested that water of the study area is not drinkable even after removal of

salts due to its contamination. Cadmium naturally exists in Soil and rocks of some extent. Besides, anthropogenic activities like unsafe use and handling of Ni–Cd batteries, industrial activities, waste treatment plant, as well as agricultural fertilizer are the source of cadmium load to the sea (HELCOM, 2007). Average concentration of Cd in the study area was found to be 0.077 ppm. Although it is in low level, yet it is contaminated. The highest concentration of Fe was observed at station 1 on the session of monsoon 2020, which was different from the values for other stations. Copper (Cu) concentration was found in the range of 0.167–0.317 ppm and average value is about 0.235 ppm. Lowest concentration was found at station 2 in pre-monsoon 2020 on the other hand highest values was found at station 1 on the session of Monsoon 2020 (Fig.1 and Fig.2). An average concentration of Fe was observed in highest value of 1.37 ppm on Monsoon year of 2020. Iron is the fourth most abundant element in the earth’s crust and also present in natural waters. In the aquatic environment, the chemical behaviour of iron is determined by oxidation–reduction reactions, pH, and the presence of co-existing inorganic and organic complexing agents. Lowest concentration of Fe was found at station 3 in value 0.62 on premonsoon year of 2019. On the other hand a highest value 1.91 was found at station 1 on monsoon 2020. ( Fig.1. and Fig.2) Nickel is omnipresent in nature and is nutrient for the function of many organisms; both anthropogenic release and naturally release responsible for higher concentrations in some areas may be toxic to living organisms (Diagomanolin et al., 2004; Haber et al., 2000; Scott-Fordsmand, 1997). In most of the samples in this research, Nickel was below detection limit. Analysis found nickel in Station 1, 2 and 3 whose values are 0.12, 0.06 ppm respectively in the year of 2019 on the session Monsoon. (Table.1) Lead is a heavy metal found as metallic lead, inorganic, and organo-metallic compounds. Tetravalent and divalent, in both forms lead is found in nature where  $Pb^{2+}$  is predominant over  $Pb^{4+}$ .  $Pb^{2+}$  salt with common anion are slightly soluble in water and its high content in aquatic environment is toxic for most forms of life, especially aquatic organisms (Branica & Konrad, 1977). The lower concentration of Pb observed in the value of 0.09 at station on the premonsoon 2019. The average value of Zn was observed in the value of 0.75 ppm. The heavy metal concentration of the study area given Table.1

Season/Year	Stations	Cd	Cr	Cu	Fe	Ni	Pb	Zn
Monsoon 2019	Station 1	0.17	0.16	0.37	1.89	0.12	0.13	1.12
	Station 2	0.13	0.11	0.31	1.24	0.06	0.11	0.84
	Station 3	0.1	0.06	0.21	0.94	0.00	0.00	0.58
Premonsoon 2019	Station 1	0.11	0.09	0.22	1.04	BDL	0.1	0.7
	Station 2	0.09	0.00	0.16	0.89	BDL	0.09	0.53
	Station 3	0.07	0.00	0.12	0.62	0.00	BDL	0.41
Post monsoon 2019	Station 1	0.14	0.15	0.3	1.37	0.09	0.12	0.84
	Station 2	0.12	0.1	0.26	1.04	0.06	0.1	0.7
	Station 3	0.09	BDL	0.17	0.76	BDL	BDL	0.46
Monsoon 2020	Station 1	0.21	0.18	0.39	1.91	0.08	0.15	1.14
	Station 2	0.18	0.13	0.33	1.26	BDL	0.13	0.86
	Station 3	0.15	0.08	0.23	0.96	BDL	BDL	0.62
Premonsoon 2020	Station 1	0.11	0.06	0.22	0.94	BDL	0.11	1.14
	Station 2	0.08	BDL	0.11	0.88	BDL	0.1	0.67
	Station 3	0.04	BDL	0.11	0.71	0	BDL	0.56
Post monsoon 2020	Station 1	0.12	0.1	0.24	1.06	BDL	0.12	0.94
	Station 2	0.1	BDL	0.18	0.91	BDL	0.1	0.67
	Station 3	0.08	BDL	0.14	0.78	0	BDL	0.49
Winter 2021	Station 1	0.16	0.16	0.37	1.08	0.06	0.13	1.12
	Station 2	0.15	0.11	0.31	0.93	BDL	0.11	0.85
	Station 3	0.13	0.06	0.21	0.86	BDL	BDL	0.64
	Average	0.120476	0.096875	0.23619	1.050952	0.047	0.106667	0.75619

**Table.1.** Represents Heavy metal concentration of the study area.

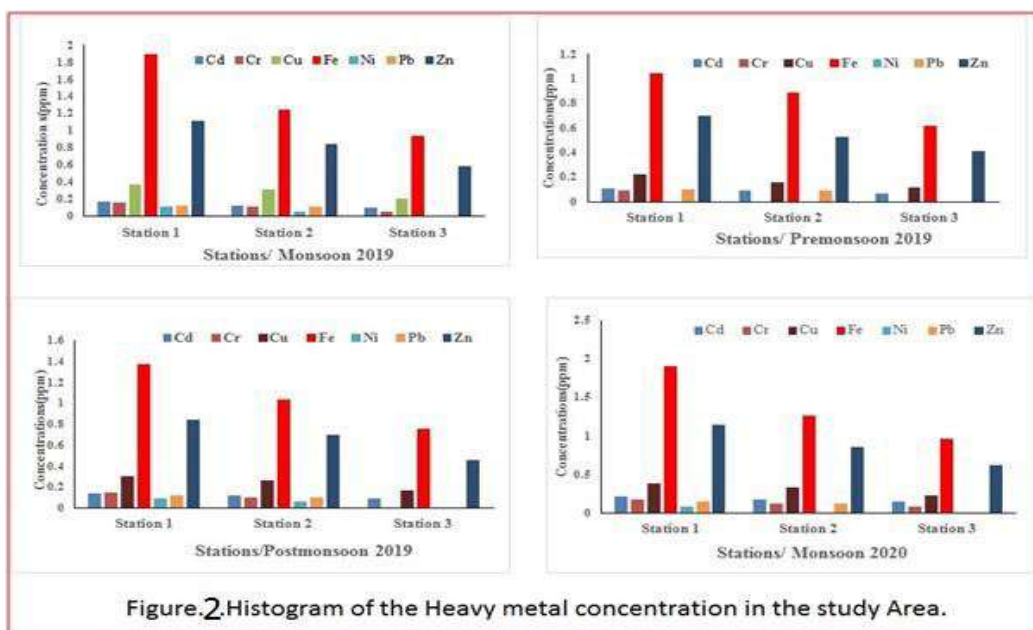


Figure 2. Histogram of the Heavy metal concentration in the study Area.

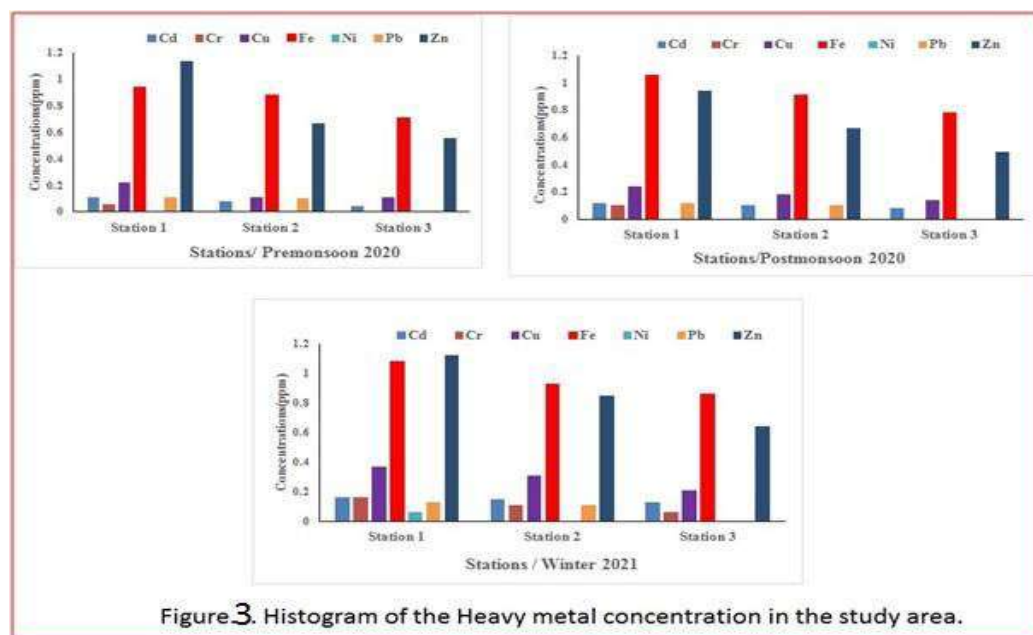


Figure 3. Histogram of the Heavy metal concentration in the study area.

### 3.2. Heavy Metal Pollution Index (Hpi)

The interpretation of water quality datasets for pollution assessment is quite difficult because of the simple elemental concentrations. On the other hand, quality indices have a great deal of flexibility in analysing data sets for better interpretation of pollution. In order to evaluate the quality of water by its heavy metal content in Study area, two indices were used. The heavy metals pollution index (HPI) and heavy metals evaluation index (HEI) proposed by are the ones used. The HPI and HEI methods are introduced to evaluate the overall quality of water by adding to heavy metals. The HPI index takes into account the relative toxicity of each metal by assigning a weighting factor or a rating ( $W_i$ ) to each chosen parameter. The scoring system is an arbitrary value between 0 and 1 and its choice depends on the importance of individual quality considerations. It can be defined as inversely proportional to the allowed standard value. In the calculation of HPI in this study, the concentration limits, that is, the allowed standard value ( $S_i$ ) and the highest desirable value ( $I_i$ ) for each parameter, were extracted from the WHO standards. The Heavy Metals Evaluation Index (HEI) is used to synchronize the criteria for different pollution indices. The HEI criteria for surface water samples are thus classified as low ( $HEI < 40$ ), medium ( $HEI = 40-80$ ), and high ( $HEI > 80$ ). Different authors define for HPI a critical limit value 100 for water intended for consumption beyond which water is considered to be of poor quality.



### 3.3. Impacts of Heavy Metals Contamination

Heavy metals enter into human body through drinking water obtained from a various source like wells, rivers, lakes, reservoirs, ponds etc. The occurrence of metals in the drinking water beyond the recommended limit prescribed by various national and international organization (Table.2) can cause health hazard. Ni and Hg are carcinogenic and cause damage to DNA (Deoxy ribonucleic acid). Ni also causes systemic toxicity, allergy, hair loss and anaemia (Salem, H.M et al.). Pb is one of the common heavy metal in general beyond desirable limit is metabolic poison and enzyme inhibitor. It can also damage nervous connections and cause blood and brain disorders. Other than this the biochemical effects of lead is its interference with haemo synthesis, which leads to haematological damage (Mohod, C.V. et al.). Fe and Mn at low concentration is needed for enzyme activity (Salem, H.M et al.,) but at high concentration, it accumulates in muscle, liver and affects brain and central nervous system (Luqueno, F.F., et al.). Cr known as carcinogenic and toxicological agent can cause dermatitis and ulceration of the skin. Long-term exposure can cause kidney, liver damage, circulatory and nerve tissue damage (Salem, H.M et al.). As at higher concentration can cause lesions on skin, hyperpigmentation, respiratory complications, hormonal change, chronic renal failure (Luqueno, F.F., et al.). Zn as needed in lower concentration for acting as catalyst in enzyme activity of living system but it accumulates in muscle and liver (Luqueno, F.F., et al.). The chronic health effects of Zn include cancer, birth defects, organ damage, disorders of the nervous system and damage to the immune system. Cd, classified as toxic trace element appears to accumulate with age, especially in the kidney and it is considered as an agent to cause cancer and cardiovascular diseases. Industrial contaminated drinking water causes bone and renal disease. With long-term exposure it can replace calcium in bones and damage kidney. Cd may interfere with the metallothionein's (a protein that binds to excess essential metals to render them unavailable) ability to regulate Zn and Cu concentrations in the body which causes elevation in zinc in urine. Cu exposed for long term or high concentration can cause chronic diseases like nervous system disorder, liver and kidney failure. Elevated level of Cu in drinking water can also cause vomiting, abdominal pain, nausea, diarrhoea and anaemia (Mohod, C.V. et al, Salem, H.M et al, Madsen, H., et al, Bent, S et al.).

Heavy Metals	USEPA, 2008 (µg/l)	WHO, 2008 (µg/l)	EU, 1998 (µg/l)	BIS (ISO:10500, 2012) (µg/l)
Fe	300	NGL*	200	300
Pb	15	10	10	10
Zn	5000	NGL**	NM	5000
Cd	5	3	5	3
Cu	1300	2000	2000	50
Hg	2	6	1	1
Cr	100	50	50	50
As	10	10	10	10
Ni	100	70	20	20
Mn	50	400	50	100

Table.2. Drinking Water Standards

(NM- Not Mentioned; NGL\* No Guideline, because it is not of health concern at concentrations normally observed in drinking water, but may affect the acceptability of water at concentration above 300 µg/L ; NGL\*\* No Guideline, because it occurs in drinking-water at concentrations well below those at which toxic effects may occur; USEPA- United States Environment Protection Agency; WHO- World Health Organisation; EU- European Standards; BIS- Bureau of Indian Standards)

### 3.4. Heavy Metal Pollution Index

Heavy Metal Pollution Index (HPI) represents the overall quality of water. The following equation model (equation 1 and II) calculates the index as:

$$HPI = \frac{\sum_{i=1}^n W_i Q_i}{\sum_{i=1}^n W_i} \quad Q_i = \sum_{i=1}^n \frac{M_i - I_i}{S_i - I_i} \times 100$$

Qi: Sub index calculated for the i<sup>th</sup> parameter, W<sub>i</sub>: Weight assigned to the i<sup>th</sup> parameter. Mi: Measured value for the i<sup>th</sup> parameter.

$I_i$ : Ideal value or highest desirable value for  $i^{\text{th}}$  parameter.  $S_i$ : Standard or permissible value allowed for  $i^{\text{th}}$  parameter. The (-) sign denotes numerical difference of the two values ignoring the algebraic

Weight of the samples are based according to the importance of the parameters that is assigned between zero to one. It can also be considered as inversely proportional to the standard value for each element [41 – 48]. Water quality based on heavy metal pollution index is categorized as: low heavy metal pollution (HPI <100), heavy metal pollution on the threshold risk (HPI = 100) and high heavy metal pollution (HPI > 100).

Heavy Metals Pollution Index	Cadmium(Cd)	Chromium	Copper	Iron	Nickel	Lead	Zinc
Station 1	0.907	0.003	0.0169	1.223	4.218	0.782	0.0246
Station 2	0.544	0.001	0.0101	7.345	2.532	0.469	3.2511
Station 3	0.401	0.001	0.007	5.418	1.868	0.346	1.7612

**Table. 3.** Heavy metals Pollutionindex of the study area.

Based on the results (Table.3), the present study found that all Pb concentrations in the surface water of the Station 1 were below the maximum allowable value (0.782 mg/l) of the WHO, 2008. Cadmium which in the present study, all samples from the Sea basin wells had values lower than the admissible WHO. No significant difference in Cd concentrations between seasons was observed in the study area. The maximum value found in all the samples of the study area was about 0.907 ppm. High concentrations of Fe were observed in Station 2 only throughout the study period with a slight seasonal fluctuation. Concentrations of Zn ranged from 0.02 to 3.25 ppm with an average of 4.66 ppm. No significant difference in Zn concentrations was observed in the study area across seasons. The average Cu concentrations observed in the study area showed lower levels compared to the maximum allowable value (0.01 ppm) for most of the wells studied. High concentrations of Cu were observed in Station 2 throughout the study period with a slight seasonal fluctuation. The average total Cr concentrations observed in the study area were lower than to the admissible Moroccan standards (0.05 mg/l) for most of the wells studied. Low concentrations of total Cr were observed in Station 1 (0.001 ppm).

## CONCLUSION

In Vellar estuary in results of heavy metal concentration allows for the identification of significant parameters and thus obtains better information on contamination sources. The results of the present study suggest that presently, the concentration of metal ions is acceptable and does not reach levels that could be harmful to human health. However, the study clearly identifies concentrations of toxic metals such as Fe, Cr, etc., present in slight excess in one or two stations in a given season. Even though the current conditions meet existing standards, problems can occur in the future if conditions are not improved to prevent groundwater from becoming severely contaminated and unsafe for consumption. Appropriate preventative measures should be implemented to protect this important resource. The HPI calculated for the surface water of Vellar estuary was found to be below the critical value of 100. This shows that groundwater in the study area is not polluted with respect to heavy metals. However, precautionary measures should be taken such as implementation of a groundwater quality monitoring program, preventing the use of wastewater in agriculture, controlling the overuse of organic fertilizers, monitoring the pre-treatment of wastewater (from factories) before discharge into the receiving environment and limiting the establishment of polluting industries.

## ACKNOWLEDGEMENT

I would like to say thank for all those who helped me a lot to bring about this journal. However it is the time of hour to show my gratitude to **Dr. S. Arunadevi** who is my research supervisor, mentor and guide. I also thankful to **Dr. R. Sivasamandy** who is the fore frontier companion to help me to in all the way to bring about the journal in time. Undoubtedly it is the time to show the full extent of gratitude and love to my wife **Mrs. Parveen Banu Jakeer** who helped me to lot for the successful completion of my research work on time.

## REFERENCES

1. Alkarkhi, AF, Ahmad, A, Ismail, N & Easa, AM 2008, 'Multivariate analysis of heavy metals concentrations in river estuary', Environmental monitoring and assessment, vol. 143, no. 1-3, pp. 179 -186.
2. Barakat, A., M. El Baghdadi, J. Rais, and S. Nadem. 2012. "Assessment of Heavy Metal in Surface Sediments of Day River at Beni-Mellal Region, Morocco." Research Journal of Environmental and Earth Sciences 4 (8): 797-806.

3. Bent, S. and Bohm, K., "Copper induced liver cirrhosis in a 13- month-old boy", *Gesundheitswesen*, 57, 10, October 1995, pp. 66-79.
4. Branica, M., & Konrad, K. (1977, October). Lead in the marine environment. Proceedings of the International Experts Discussion on 'Lead-Occurrence, Fate and Pollution in the Marine Environment (pp. 233–261). Rovinj.
5. Diagomanolin, V., Farhang, M., Ghazi-Khansari, M., & Jafarzadeh, N. (2004). Heavy metals (Ni, Cr, Cu) in the Karoon waterway river, Iran. *Toxicology Letters*, 151, 63–67.
6. Haber, L. T., Erdreich, L., Diamond, G. L., Maier, A. M., Ratney, R., Zhao, Q., & Dourson, M. L. (2000). Hazard identification and dose response of inhaled nickel-soluble salts. *Regulatory Toxicology and Pharmacology*, 31, 210–230. <http://dx.doi.org/10.1006/rtp.2000.1377>
7. Helcom. (2007). Heavy metal pollution to the Baltic sea in 2004 HELCOM. *Baltic Sea Environment Proceedings No.106* (33 pp.).
8. Liu, J, Zhang, B, Cao, J, Cao, Z & Domagalski, J 2009, 'Ecological risk of heavy metals in sediments of the Luan River source water, *Ecotoxicology*, vol. 18, no.6, pp. 748 – 758.
9. Liu, J., Diao, Z., Xu, X., Xie, Q., 2019a. Effects of dissolved oxygen, salinity, nitrogen and phosphorus on the release of heavy metals from coastal sediments. *Sci. Total Environ.* 666, 894–901. <https://doi.org/10.1016/j.scitotenv.2019.02.288>
10. Luqueno, F.F., Valdez, F.L., Melo, P.G., Suarez, S.L., Gonzalez, E.N.A., Martinez, A.I., Guillermo, M.S.G., Martinez, G.H.M., Mendoza, R.H., Garza, M.A.A. and Velazquez, R.P., "Heavy metal pollution in drinking water - a global risk for human health: A review". *African Journal of Environmental Science and Technology*, 7, 7, September 2013, pp. 567-584.
11. Miranda, L.S., Ayoko, G.A., Egodawatta, P., Hu, W., Ghidan, O., Goonetilleke, A., 2021. Physico-chemical properties of sediments governing the bioavailability of heavy metals in urban waterways. *Sci. Total Environ.* 763, 142984 <https://doi.org/10.1016/j.scitotenv.2020.142984>.
12. Mohod, C.V. and Dhote, J., "Review of heavy metals in drinking water and their effect on human health", *International Journal of Innovative Research in Science, Engineering and Technology*, 2, 7, 2013, pp. 2992-2996.
13. Madsen, H., Poulsen, L. and Grandjean, P., "Risk of high copper content in drinking water". *Ugeskr. Laeger*, June 1999, 152, 25, pp. 1806 - 1809.
14. Saghali, M. ; Baqraf, R. Patimar, R.; Hosseini, S. A.; Baniemam, M. Determination of heavy metal (Cr, Zn, Cd and Pb) concentrations in water, sediment and benthos of the Gorgan Bay (Golestan province, Iran) *Iranian Journal of Fisheries Sciences* 13(2) 449- 455 2014
15. Scott-Fordsmand, J. J. (1997). Toxicity of nickel to soil organisms in Denmark. *Reviews of Environmental Contamination and Toxicology*, 148, 1–34.
16. Salem, H.M., Eweida, A.E., Farag, A. "Heavy metals in drinking water and their environmental impact on human health", proceedings in ICEHM, Cairo University, Egypt, 2000, pp. 542- 556.
17. Storelli, M. M., Storelli, A., D'ddaabbo, R., Morano, C., Bruno, R. & Marcotrigiano, G.O., (2015). Trace elements in loggerhead turtles (*Caretta caretta*) from the Eastern Mediterranean; Overview and evaluation. *Environmental Pollution*, 135, 163–170
18. Yilmaz F., et al. "Heavy metal levels in two fish species *Leuciscus cephalus* and *Lepomis gibbosus*". *Food Chemistry* 100(2007): 830-835.

## **An Study on Investors Awareness and Their Perception towards Mutual Fund As an Emerging Option for Investment in A Developing Economy-With Special Reference to Tumkur City an Indian Context**

**Roshan K\* and M. R Jhansi Rani**  
ISBR Research Centre, University of Mysore, India

### **ABSTRACT**

Mutual funds as an investment option in India did not had a enormous leap growth from its inception way from 1963 as unit trust of India initiated by government of India and reserve bank. Even the government steps to popularise the concept as it's a tool which can deliver returns as well as a economic tool for mobilising savings in economy towards a focused objective. Compared to developed economies the mutual fund assets and its share in India gross domestic product in 2019 is still at 12%.where the AUM of USA is greater than its GDP standing at 103%.Further the penetration of mutual funds is not even compared to top 15 cities the other parts of India contribution is very narrow. To understand the reality of investor's mindset a study is needed in this direction. So a research is designed and carried out in Tumkur city nearest place to Bangalore is carried out to understand people perception and awareness level.

Keyword-Mutual funds, awareness, perception, investment option, India.

### **INTRODUCTION**

The birth of mutual as concept was first formed by king William of nether land in year 1822 as Socioete Generale de Belique. This concept was also given birth in India by the government and reserve bank through formation of unit trust of India in 1964 to start and operate mutual fund business in India. The objective of brining this concept was to give direction to small investors through giving them an opportunity to invest into capital market and realise capital apperception in long term. As the economy was on a growth path supported by various five years plans retail investors were finding it difficult to invest into stocks directly and speculate returns. Later the stock exchanges witnessed a array of scams which manipulate by few informed cartels wiped out lakhs of hard earned middle class investors investment. so with all this many regulators entered to regulate the investment market and balance the capital markets in India.

**What is Mutual Fund-** in simple its a pool of money collected by a professional asset management company from various size of investors and invest into various securities like shares, scripts, bonds, debentures and even commodities also. But the investment decision and managing the investment is vested to fund manager who has an expertise and vision towards capital apperception and returns delivery to the investors who have parted with their money towards a common fund objective.

In India this concept is growly at a slow phase as its acceptability among Indian population is not at the level what's there in other developed countries or even developing economies. Various studies have revealed that Indian consumers are more conserve in nature while choosing investment option, even though few have also highlighted that demographic factor also creating a bias. The education lack and large population is also contributing to underdevelopment of concept in India. If we compare to the economies like usa the mutual fund market in 2018 was USD 17.71 trillion the market is predicted to increase to 23.73 trillion by 2024.In the world the usa mutual fund is the largest in the world, while as india mutual fund market stood at ₹ 28,33,890 crore. But it also has witnessed a growth from 2015 that is the assest under management which stood at ₹ 13.24 trillion as on October 31, 2015 has grown to the size of ₹28.23 trillion as on October 31, 2020.This clearly predicts that mutual fund as a concept is going to stay for long and penetrate in India.

### **LITERATURE REVIEW**

**Umaya Salma Shajaha (2014)** In the research has pointed out that factors like saving for milestones, for emergency needs liquidity and source of income influence the investors while investing and also study concluded that investors seeks information to decide on investment

**Paul (2014)** This research has found that there is a communication gap between mutual fund companies and the investors at large, which in turn has resulted in failure of investors beliefs.

**Subramanyapr(2015)** In his study have highlighted that many social and economic factor like age, level of education, personal income and savings of house hold are not directly effecting perception on mutual fund but the savings habit is largely effected by age of investor

**Ranganathan (2016)** In his research attempt tried to find what is objective which has influence the most while investor choose to invest, the research randomly investigated on 100 samples which revealed the most important factor to save was keeping their retirement in objective.

**Dr. B. Ravi Kumar & R. Padma Malini(2017)** The investigation revealed that many investors are investing still in bank deposits, lack of information makes investors to hesitate to investment into a knowledge concept like mutual fund.

**Amsaveni and Ranjini (2018)** The research have found that people are having an positive attitude towards mutual funds and but they also have preference towards high yield mutual fund.

### **SIGNIFICANCE OF THE STUDY**

In the present era where technologies, smart phones and internet access is a excellent arena to spread the benefit of concept of mutual funds to vast population mass in India. The developed nation's population have reaped the benefits of this concept from a longer time in history, so to popularise this even in our nation efforts were put nearly 5 decades back and still it's on. If this concept is really achieved its sense it can create a finer balance to investors as well can become economic tool for economy building. But data has revealed that mutual fund as an investment option is in average phase of growth, still it has a long way to go to become well received.

### **OBJECTIVE OF STUDY**

- To understand the level of awareness among people about mutual funds
- To investigate the perceptions and attitude towards mutual fund
- To promote Mutual Fund as the emerging productive investment avenue for investing

### **PLACE OF STUDY**

**Tumkur-** This city is chosen as it falls near to Bangalore city distancing around 70 kms As Bangalore is a significant contributor to mutual fund business in India being one among metros in India and also featuring in top 15 city contributing largely towards mutual fund investment.

### **DATA COLLECTION-**

**Primary data** – a structured questionnaire is designed keeping the objectives in mind to be administrated among the population of study.

**Secondary data-** data were assimilated from sources like news paper article, Amfi bulletins, and research articles.

### **RESEARCH DESIGN**

**Method of sampling:** Random sampling

**Sample:** 100 size population.

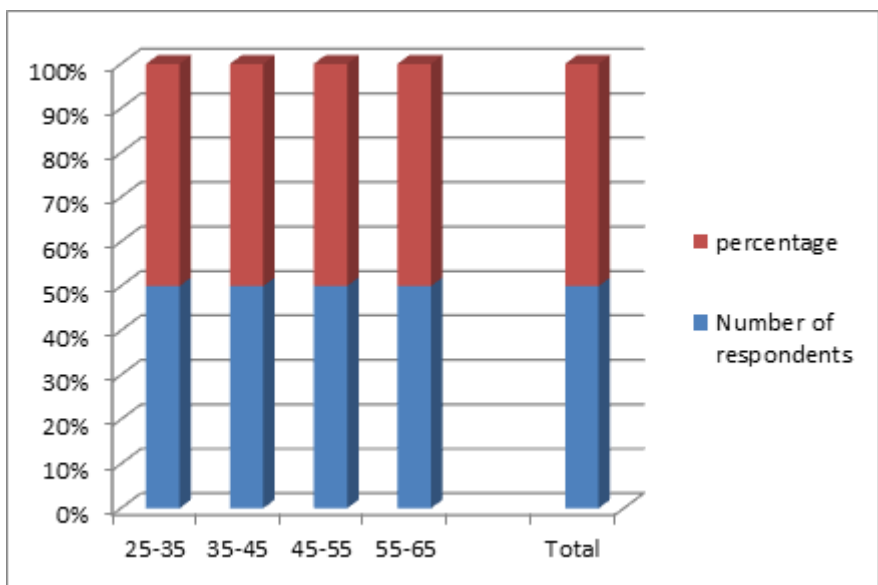
**Statistical techniques:** simple statistical diagrams and multivariate table's analysis.

### **RESEARCH QUESTIONS**

#### **1. What is age of the respondents-?**

Question was asked to assess the age of the respondents to find out the demography of investor population

Age band	Number of respondents	percentage
25-35	20	20
35-45	31	31
45-55	27	27
55-65	22	22
<b>Total</b>	<b>100</b>	<b>100</b>

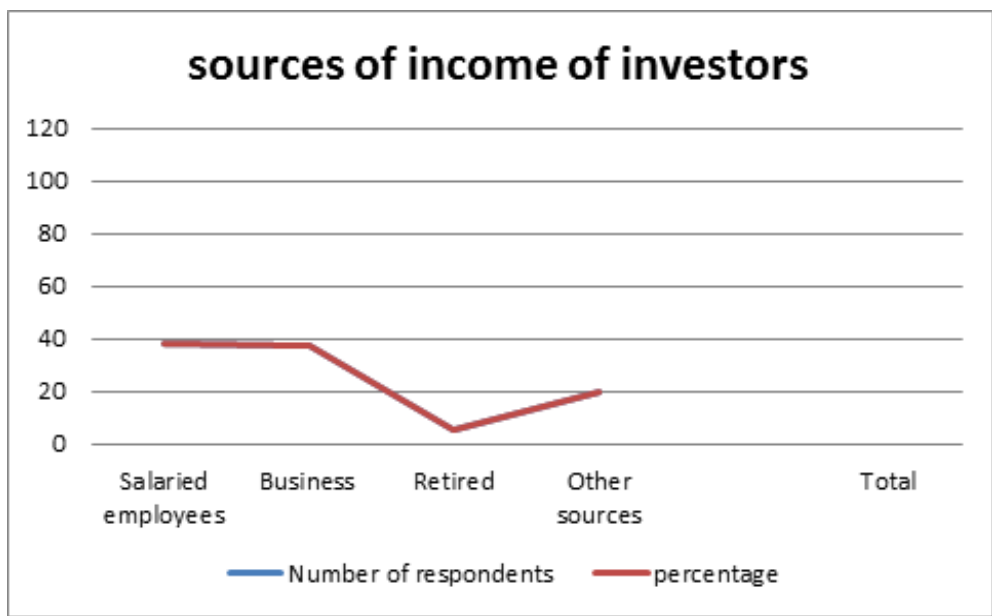


**INTERPRETATION**

When study was conducted below 25 years there were no investment activity found as majorly it comprises of student community and early career beginners. But the major investment is found under the age band of 35-45 which is peak earning life and there comes the element of savings and investment.

**2. What is the occupation of respondents to assess the source of income?**

Source of income of investors	Number of respondents	percentage
Salaried employees	38	38
Business	37	37
Retired	5	5
Other sources	20	20
<b>Total</b>	<b>100</b>	<b>100</b>

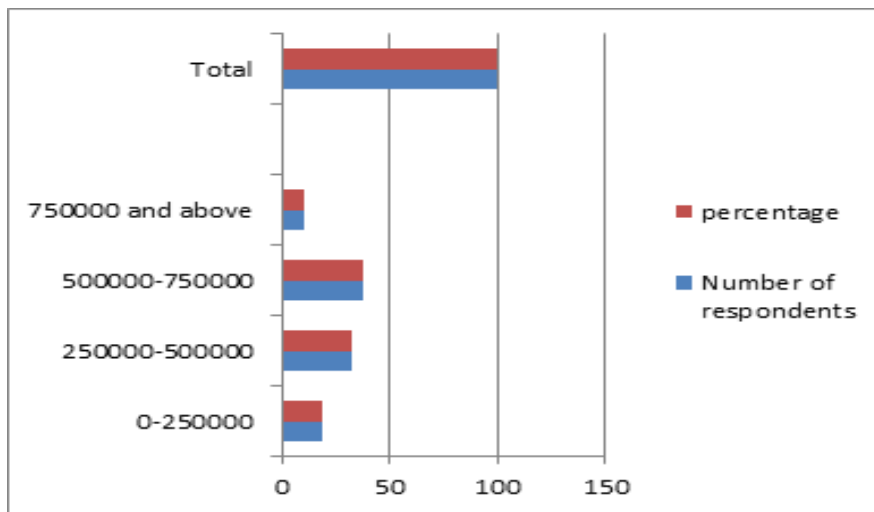


**INTERPRETATION**

When the profiles of investors were asked to know the sources of income it has revealed that majorly the investment population falls in salaried community as people are engaged in occupation of various sectors which yields them regular source of income, followed by the business community who are doing some self occupation to generate income. Where as the smallest population was retired community and also the study revealed a segment which is categorised as others where people are having sources of income from rent, and odd projects which generates some income to them to save and also to invest.

**3. What is the income level of respondents?**

Income band	Number of respondents	Percentage
0-250000	19	<b>19</b>
250000-500000	33	<b>33</b>
500000-750000	38	<b>38</b>
750000 and above	10	<b>10</b>
<b>Total</b>	<b>100</b>	<b>100</b>

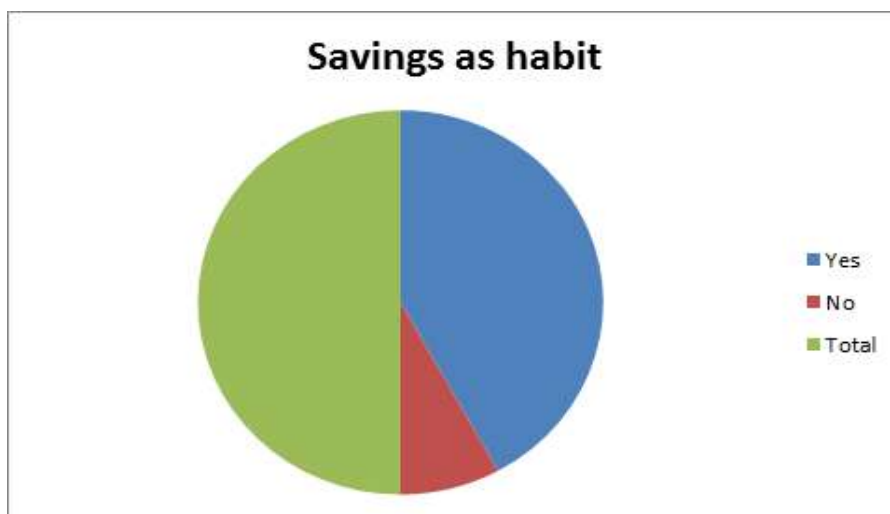


**INTERPRETATION**

The study reveals that nearly 19% of population fall in low income band, where as nearly 33% of population falls in the middle income group which consist of income level of 2.5 laks to 5 laks. The major of all among the population under study is band of 5 laks to 7.5 laks where nearly 38% of population is falling which is higher middle income group. Lastly the high income group of 7.5 laks and above is 10% which are the high net worth individuals who have higher income and disposable income bracket.

**4. Do you feel saving regularly is an important element in human life?**

Opinion-yes/no	Number of respondents	Percentage
Yes	84	<b>84</b>
No	16	<b>16</b>
<b>Total</b>	<b>100</b>	<b>100</b>

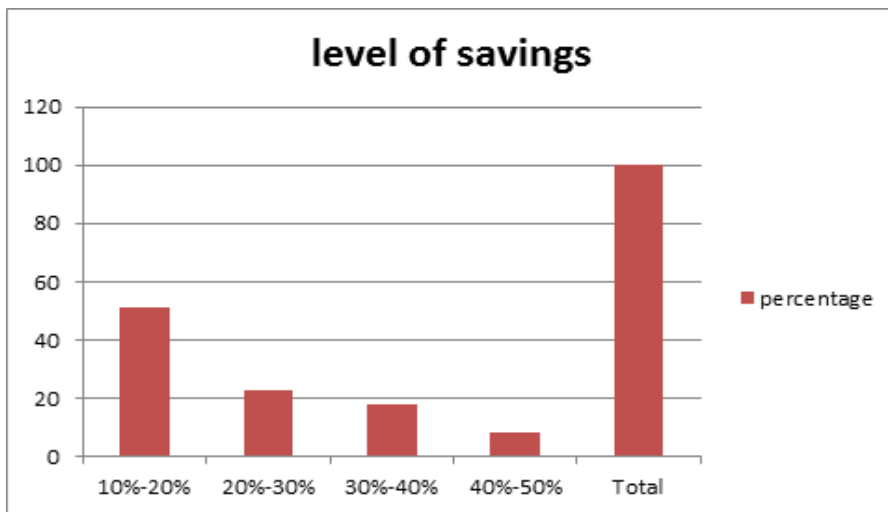


**INTERPRETATION**

When the basic question was asked whether savings is important as when human life has economic value and also prone towards uncertainties, when questioned about savings people said and acknowledged that savings is essential and has to be cultivated among all. But nearly 16% of respondents felt savings is not important they felt they will manage uncertainties or milestone with a contingency approach.

**5. What is the percentage of amount which u can afford to save regularly?**

Level of savings-%	Number of respondents	percentage
10%-20%	51	51
20%-30%	23	23
30%-40%	18	18
40%-50%	8	8
<b>Total</b>	<b>100</b>	<b>100</b>

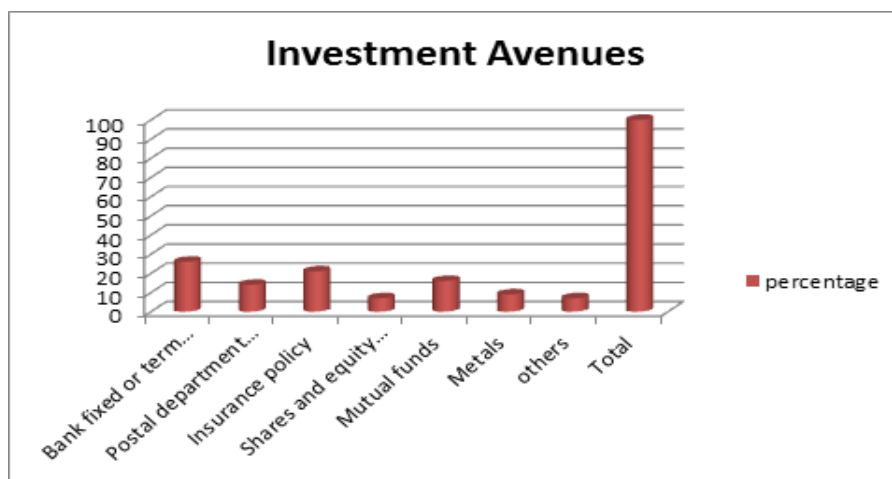


**INTERPRETATION**

In order to find out what's the capacity of the respondents and what actually they are savings the research question revealed that nearly half of population under study are actually savings around 10 to 20% of their income as savings, the population also revealed that its very comfortable to save 20% this range does not affect their normal living expenses. Then around 23% of population said they can and are savings up to 30% of their income. Surprisingly the study revealed that nearly 8% of population can afford nearly 50% of their earning as savings which shows that seriousness towards the habit of savings in India.

**6. What are the financial avenues do you prefer to invest your savings?**

Investment avenue	Number of respondents	percentage
Bank fixed or term deposit	26	26
Postal department instruments	14	14
Insurance policy	21	21
Shares and equity related instruments	07	07
Mutual funds	16	16
Metals	09	09
others	07	07
<b>Total</b>	<b>100</b>	<b>100</b>



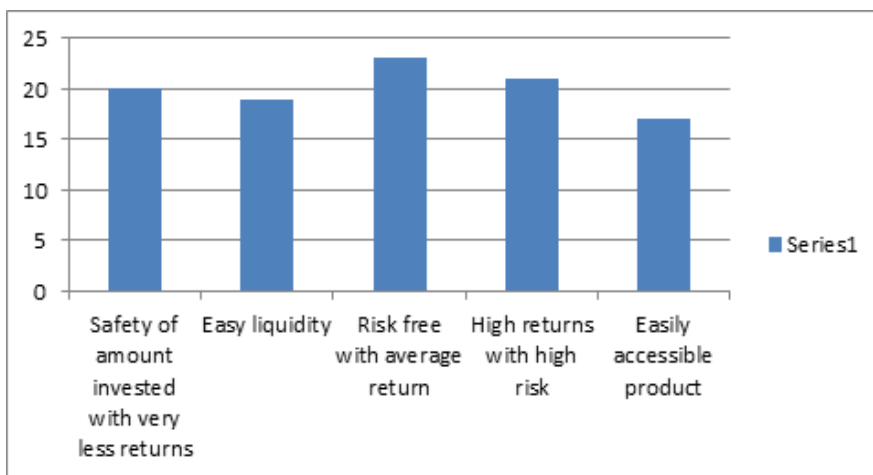


**INTERPRETATION**

When question was asked what's the preference and their choice of investment instrument majority of population showed inclination towards bank products and insurance products followed by postal department products, the study also revealed that people are even opting for non structured products like chit funds and products of small local finance company .interesting 16% of people out of 100 sample have shown preference towards mutual fund.

**7. What the factors do you consider while investing into any investment product?**

Considered factors	Number of respondents	percentage
Safety of amount invested with very less returns	20	20
Easy liquidity	19	19
Risk free with average return	23	23
High returns with high risk	21	21
Easily accessible product	17	17
<b>Total</b>	<b>100</b>	<b>100</b>

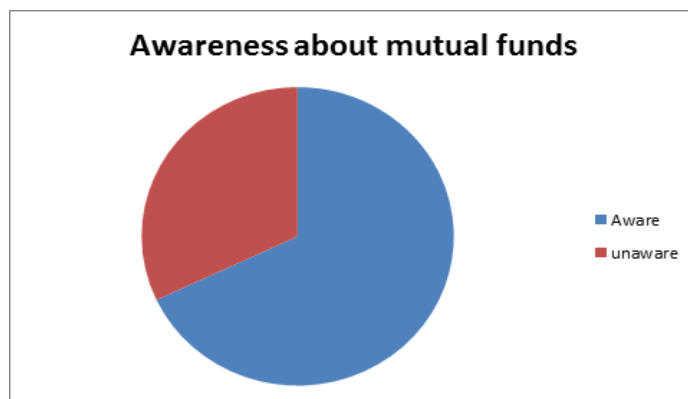


**INTERPRETATION**

When the respondents were posed with question of what factors do they consider while investing into any financial product many people showed preference towards factor like average returns with less risk is preferred the most and also study revealed that when the financial instrument is easy to accessed is also given due importance while investing. Secondly people also prefer safety as priority with very less returns also proves many investors in India are risk averse category.

**8. Are u aware of the concept mutual funds where savings can be invested for short term and long term goals?**

Knowledge of concept	Number of respondents	percentage
Aware	68	68
unaware	32	32
<b>Total</b>	<b>100</b>	<b>100</b>

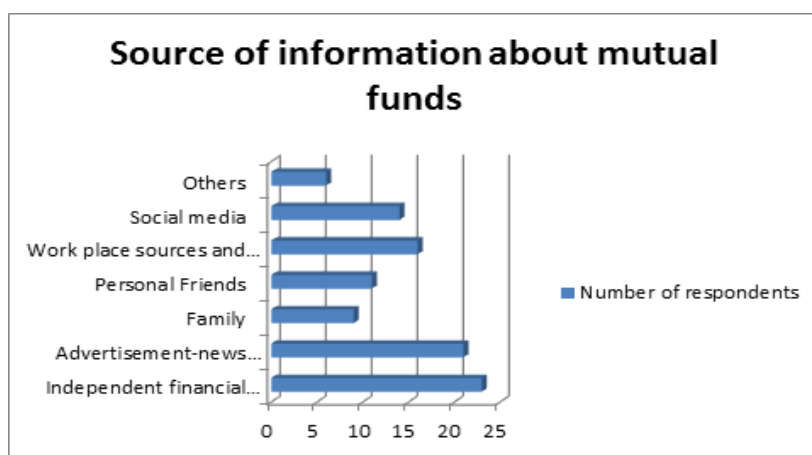


### INTERPRETATION

When a basic question was asked to the respondents about whether they have heard or know about an concept called mutual fund which is also a instrument to invest and saving tool, nearly 68% of population said yes they had heard about mutual funds and there are aware about it. But 32% said they are completely unaware and have not heard about the concept anywhere.

#### 9. How have u become aware about mutual fund concept?

Source of information	Number of respondents	percentage
Independent financial advisors	23	23
Advertisement-news paper, tv ad, flyers etc	21	21
Family	09	09
Personal Friends	11	11
Work place sources and professional workgroup	16	16
Social media	14	14
Others	06	06
<b>Total</b>	<b>100</b>	<b>100</b>

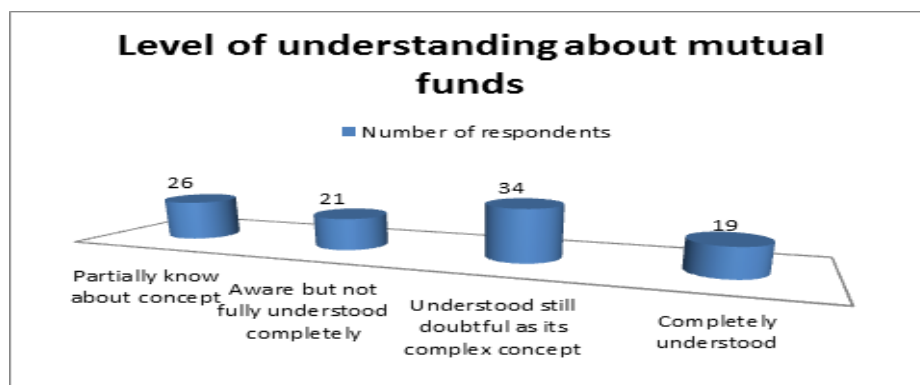


### INTERPRETATION

During the study an attempt was made to know what are sources from which the respondents are knowing about mutual fund concept, it was found that many sources are spreading knowledge about the concept mainly financial advisors are active, followed by various advertisement initiates by fund houses and knowledge sharing partners are active in wide spreading the concept and increase the penetration.

#### 10. How do you understand the mutual fund as an investment concept?

Level of understanding	Number of respondents	percentage
Partially know about concept	26	26
Aware but not fully understood completely	21	21
Understood still doubtful as its complex concept	34	34
Completely understood	19	19
<b>Total</b>	<b>100</b>	<b>100</b>

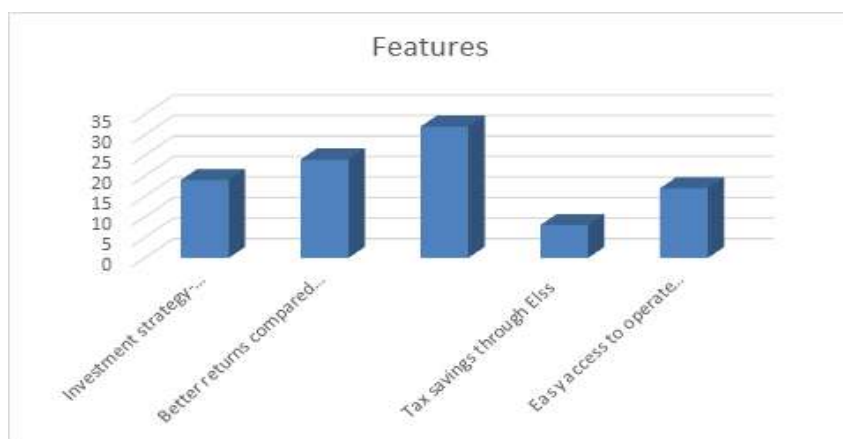


**INTERPRETATION**

In order to explore the level of knowledge quotient towards mutual fund concept a question was asked in what extent they have understood it, the study revealed that nearly 26% know partial about it, where as many fall in category of have understood still many doubts pertaing the mechanism and philosophy about the concept is therein the mind of respondents. Only a small population of 19% have understood it and completely aware of the working of the investment concept.

**11. What are the features that motivated you to invest into mutual’s funds?**

Features	Number of respondents	percentage
Investment strategy-diversification	19	19
Better returns compared to traditional products	24	24
Opportunity to contribute less and invest regularly	32	32
Tax savings through Elss	08	08
Easy access to operate investment –to invest and redeem	17	17
<b>Total</b>	<b>100</b>	<b>100</b>

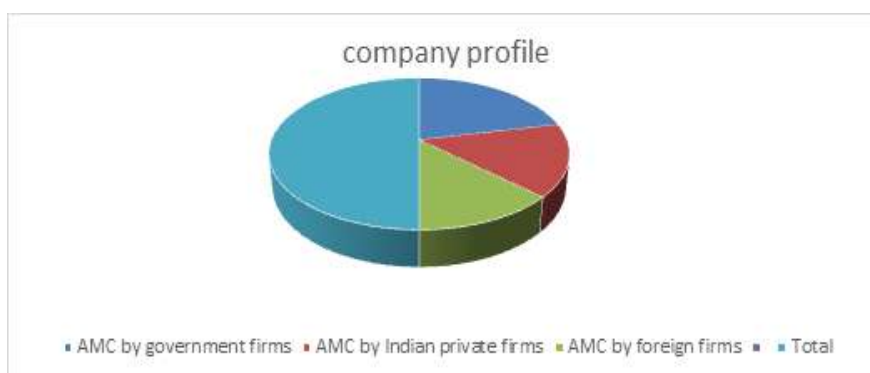


**INTERPRETATION**

When the question was raised about what attracted the respondents to become investors of mutual fund it was discovered that traditional investors also open up to diversified risk products which gives safety of principal and reduces investment risk, secondly the feature is that people wants to save regularly and save in smaller magnitude without effecting there life balance nearly 32% likes this option. Even mutual fund as a tax savings also contributes to its popularity in small scale ,lastly easy access to investment option is also given priority such as easy to invest, to understand and redeem it for liquidity also holds importance.

**12. Which mutual fund company do feel secure to invest?**

Company profile	Number of respondents	percentage
AMC by government firms	43	43
AMC by Indian private firms	31	31
AMC by foreign firms	26	26
<b>Total</b>	<b>100</b>	<b>100</b>

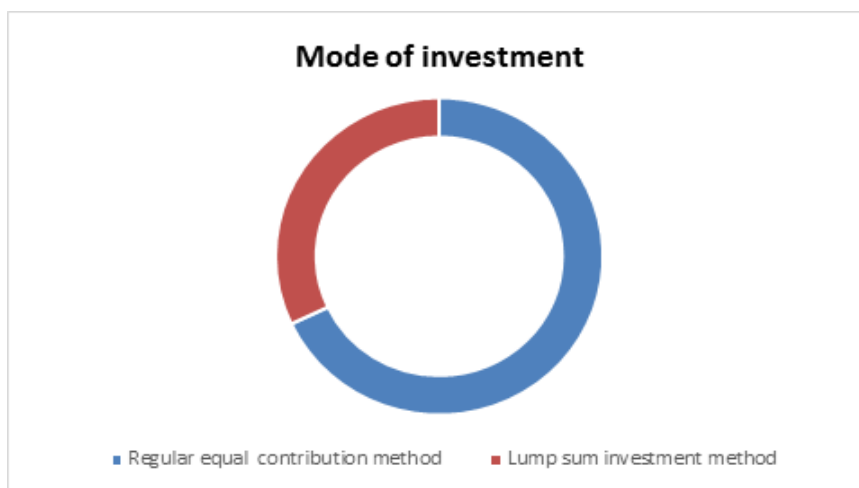


**INTERPRETATION**

In order to understand the investors liking towards the ownership of mutual fund companies people showed a strong preference towards government fund houses as they feel secure as its backed up by government. Also people didn't hesitate to invest into private and foreign fund houses operating in India looking at their history.

**13. Which is the most convenient method to invest into mutual funds?**

Method of investment	Number of respondents	percentage
Regular equal contribution method	68	68
Lump sum investment method	32	32
<b>Total</b>	<b>100</b>	<b>100</b>

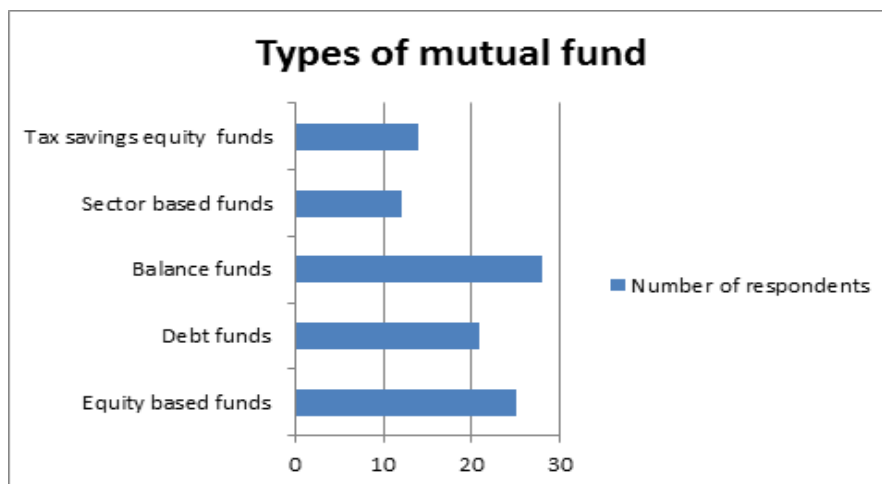


**INTERPRETATION**

In order to find out which is the ease method to invest into mutual funds majority of population showed strong liking towards investing regularly small amounts which can be saved regularly in small proportion and contributed nearly 68% of population invested into this method where monthly they can invest on prefixed date with a predetermined amount. Rest of population wanted to invest lump sum amount as they want to invest when they have amount to invest rather than getting committed for regular contribution.

**14. Which are types of funds which you prefer to invest?**

Types of fund	Number of respondents	percentage
Equity based funds	25	25
Debt funds	21	21
Balance funds	28	28
Sector based funds	12	12
Tax savings equity funds	14	14
<b>Total</b>	<b>100</b>	<b>100</b>

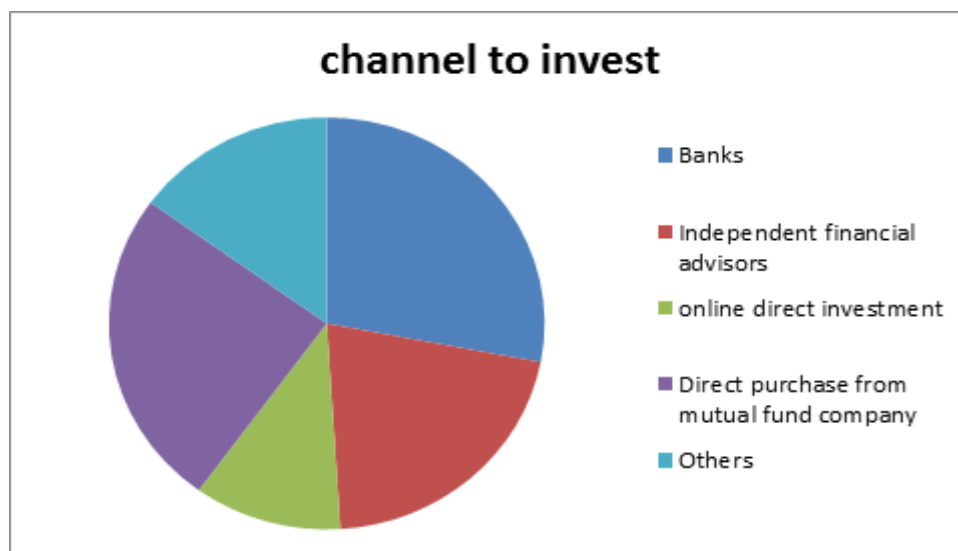


### INTERPRETATION

To investigate which is the fund choice where people prefer to invest into order to achieve life mile stones short or long runs, the survey revealed that people prefer a balance fund which mixes equity and gilt markets. People also like to invest into equity finds like diversified, mid- caps funds or small- cap to reap the benefit of capital market returns .where as investors fascinated by particular sector like banking, pharma or technology or even capex funds are preferring sector based funds. Some investor who just look at tax savings prefer equity linked savings schemes for tax purpose with long term lock in advantage.

#### 15. From which channel do you want to buy or invest into mutual funds?

Sources to buy/invest	Number of respondents	Percentage
Banks	28	28
Independent financial advisors	21	21
online direct investment	11	11
Direct purchase from mutual fund company	25	25
Others	15	15
<b>Total</b>	<b>100</b>	<b>100</b>



### INTERPRETATION

A question was designed to know from where people want to buy or invest into mutual, majority of population liked to transact into mutual funds through their bank as it builds their confidence and also convenient to transact. Secondly they also like to buy from direct fund houses and get serviced by fund houses as it brings trust into concept and the fund houses. Even people like to buy from their personal financial advisor who advise them and help in investment selections. last preference was towards direct investment into mutual fund through online which many didn't feel comfortable to transact with.

### RESEARCH FINDINGS FROM THE STUDY

- The research revealed that in a developing economy like India financial literacy is not scaled compared to the developed economy like us, uk.
- Large Population are oriented towards traditional products
- The income level has effect on savings capacity but it's not constrains from non investment low income group also showed keen into savings and investing into option to realise life goals
- Media and communication is contributing in educating people well with personal financial advisors contribution in making population understand new products
- The investor population tries to strike a finer balance between risk and return on a thin slicing edge as people with low and mid range income band tries to arbitrage between traditional and non traditional investment options
- Access to option also contributes at large in savings mobilization

### RESEARCH SUGGESTIONS

- The research suggests that in order to make population orient towards various financial options to venture the attempt should be education financial literacy to be imbibed from a young age could create knowledgeable population.
- The study revealed that the low income band showed more keen towards savings than the high income group which shows that if mutual funds are well marketed by fund house in order to make them realise the benefit of long term investment it can penetrate to masses.
- People over a period in a mixed economy of India have developed a psychological trust towards government owned corporations which shows that a ample space for government institutions to operate and launch mutual funds which can tailor the needs of small investors
- The savings habit also indicate the population finds it ease to invest in small amounts at regular intervals as it won't imbalance the economic life of the family which shows a grave need of penetrating systematic investment method among the rural and masses with low income capacity to build up the savings habit.

### CONCLUSION

As seen in the recent articles the data shows the mutual fund market in India in its size is 11% in terms of penetration when compared to world which stands at average of 55%, while the us market Aum is almost 103% more than its Gdp. It's evident that the developed economy with its robust banking and technology sectors could educate the population and make the concept to be accepted at large. But India has witnessed a slow growth in making this concept as a viable option to large economic population of India. On the positive the last decade has seen a growth from ₹ 6.46 trillion as on October 31, 2010 to ₹28.23 trillion as on October 31, 2020 which is four fold growth. India with its huge earning population if the habit of savings in small magnitude is made acceptable then mutual fund can emerge as a major investment tool.

### REFERENCE

1. Singh, B. K., Jha, A.K., "An empirical study on awareness & acceptability of mutual fund", Presented on Regional Student's Conference, ICWAI, pp. 49-55, 2009
2. Anand, S., Murugaiah, V., "Marketing of financial services: strategic issues", SCMS Journal of Indian Management. 2004
3. PreetiKhitoliya (2014), "Investors Awareness and Perceived Risk Attitude towards Mutual Fund: An Empirical Study In Delhi", International Journal of Commerce, Business And Management (IICBM), ISSN: 2319-2828, Vol. 3, No. 3.
4. Subramanya, P.R. (2015), "Investors perception towards mutual fund (with special consideration of socio-Economic variables)", International Multidisciplinary Research Journal, Vol. 2, Issue 1.
5. Amsaveni, R. and Ranjini, S. (2018). Investor's attitude towards mutual fund in Coimbatore city. International Journal of Advanced Scientific Research and Management, 3(5), 135-139
6. Ramamurthy, B. M and Reddy, S (2005), —Recent trends in Mutual Fund Industry, Journal of Indian Management.
7. Rajeswari, T. R., and V. E. RamaMoorthy, (2001), "An Empirical Study on Factors Influencing the Mutual Fund / Scheme Selection by Retail Investors", Retrieved on May 2008 from <http://www.utiiicm.com/Cmc/PDFs/2001/rajeswari.pdj>.
8. Avadhani V.A., 2008, Investment Management, Himalaya Publishing House, Mumbai, 7th Revised Edition.

## Synthesis and Biological Evaluation of Novel N-Substituted Isatin Derivatives as Potent Antimicrobial Agents

K. M. Borse<sup>1\*</sup>, Narendra Sonawane<sup>2</sup> and Pundalik Mali<sup>3</sup>

<sup>1</sup>Department of Chemistry, S.S.V.P. S, L.K.Dr.P.R. Ghogrey Science College, Dhule- 424002, Maharashtra, India

<sup>2,3</sup>Department of Chemistry, B.S.S.P. Mandal's Arts, Commerce & Science College Songir, Dhule- 424002 Maharashtra, India

### ABSTRACT

Based on existing reports various new isatin derivatives have been synthesized by the method of N- alkylation using different entity in the presence of a base give's series of compounds (3a-3e) with great yields. Spectroscopic methods (FT-IR, <sup>1</sup>H NMR) and mass spectrometry used to confirm the chemical structures of these compounds. Furthermore, N-acetylation of isatin followed by chlorination furnished a new series of compounds (3f- 3g) which allowed the analysis of the effect of isatin N-substitution on the biological activity of the resulting compounds. The results reveals that the compound with amide as substituent exhibited good antibacterial and anti-fungal activities against almost all the micro-organisms. The majority of the compounds have good antibacterial action against diverse species, according to the final results

Keywords: Isatin. N-alkylation, aromatic/alkyl/aryl halides, antibacterial and antifungal.

### I. INTRODUCTION

The Isatin or 1H-indole-2,3-dione, is an indole derivative containing keto group and consists of pyrrolo ring fused with benzene ring. The literature found that, at the earliest method for the synthesis of isatin was on oxidation of indigo with nitric acid and chromic acids [1]-[3] Isatin and their derivatives are also found in humans as it is a metabolic derivative of adrenaline [4]. The major goals of organic and medicinal chemistry are to design, synthesize, and produce molecules, all of which have a high therapeutic value. Isatin is a versatile chemical building block which is having a wide range of pharmacological actions since the discovery of heterocyclic nucleus, including antibacterial, anticancer, antiviral, anticonvulsant, anti- inflammatory, and analgesic. A number of research groups have attempted to investigate the synthetic aspect of isatin [5], [6].

Furthermore, literature found that isatin, indirubin, substituted isatin and indirubin derivatives were reacted with amines and sulfonamide to form a series of Schiff's bases. The antimicrobial and antifungal activity of the synthesized compounds perform better antibacterial activity as compare with the reference drugs [7].

On the other hand, N-substituted derivatives of isatin have been among the most interesting class of compounds especially in anti-fungal and antimicrobial drug research. In a series of focused studies on N- substituted and N-acetylation of isatin with aromatic ring, with different functional groups. we have found some potent antimicrobial and anti-fungal compounds among indole-based hydrazones derived from substituted indole-3-carboxaldehydes and benzaldehydes [8]-[10]

The disc diffusion test method is used to determine antibacterial activity of novel heterocyclic compounds. It is generally utilized as a preliminary stage for additional studies because it provides access to primarily qualitative results, due to the fact that it is accepted as reliable and reproducible. The method adopted is a modification of Hayes and Markovic's method [11].

Based on the above considerations and using the molecular hybridization strategy, in the present study a series of compounds containing isatin with N-alkylation and N-acylation fragments were designed. **Scheme1** and **Scheme2** As a result, structural alteration of the isatin derivatives moiety is still important. The application of synthetic N-alkylation methods in the presence of a base (K<sub>2</sub>CO<sub>3</sub>) and a catalyst between 1H-indole-2,3-dione and alkylating agents with good to exceptional yields was the focus of this study. Spectroscopic techniques such as IR, <sup>1</sup>H NMR and Mass spectrometry were used to characterize the produced isatin derivatives. In addition, they were tested in vitro for antibacterial activity against two Gram positive bacteria, Staphylococcus aureus and Bacillus cereus, as well as two Gram negative bacteria, Escherichia coli and pseudomonas aeruginosa.

## 2. Experimental

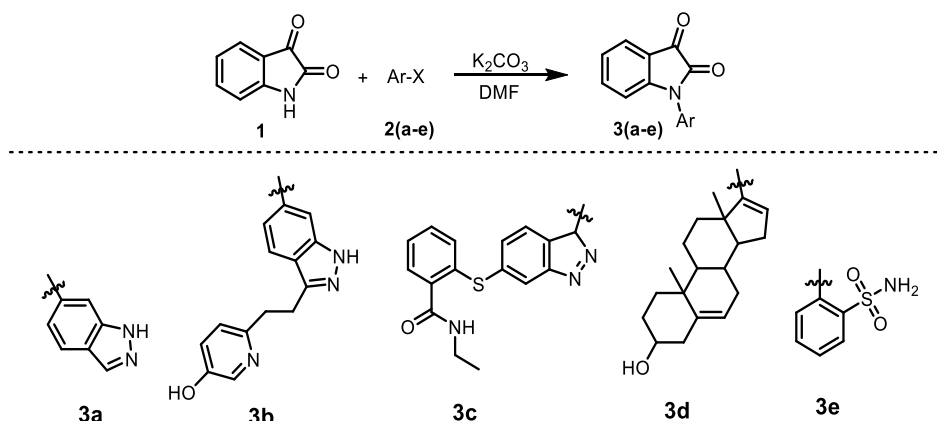
The Kofler bench instruments method was used to determine all melting points. The  $^1\text{H}$  and  $^{13}\text{C}$  NMR spectra were obtained in DMSO using a Bruker 400 NMR spectrometer with tetra methyl silane (TMS) as a reference. Parts per million are used to describe chemical changes. Thin layer chromatography (TLC) on silica gel was used to monitor reactions, and plates were seen with ultraviolet light or iodine. Merck silica gel 60 (0.043-0.06 mm) was used for column chromatography. The alkylation approach was used to make isatin derivatives. **Scheme 1** show the synthetic procedures used to acquire the target molecules. The salts and DMF are removed by filtration when the reaction is complies.

### 2.1.1 General Procedure for the Synthesis of N-Substituted Isatin (3a-3e)

Equimolar quantities of Ar-X and isatins (1 mmol of each) were added in a 100 mL two necked flask containing DMF (10 ml). Stir the reaction mass for 5-10 min and  $\text{K}_2\text{CO}_3$  (2.0 mol) were introduced under a nitrogen atmosphere. Then, heat the reaction mass to 65-70  $^\circ\text{C}$  for 6-8 hours. The progress of the reaction was monitored using TLC. Thereafter, cool the reaction mass to 25-30 $^\circ\text{C}$  and add ice-cold water (40 ml). Stir the reaction mass for 1 hour. Filter the solid observed and wash with water (10 ml) to obtain N- substituted Isatin (3a-3e) (a light-yellow to off white powder) is obtained.

The derivatives N-substituted isatin (3a-3e) thus prepared had sufficient analytical purity. The solid was recrystallized in ethanol: water to afford the titled compounds.

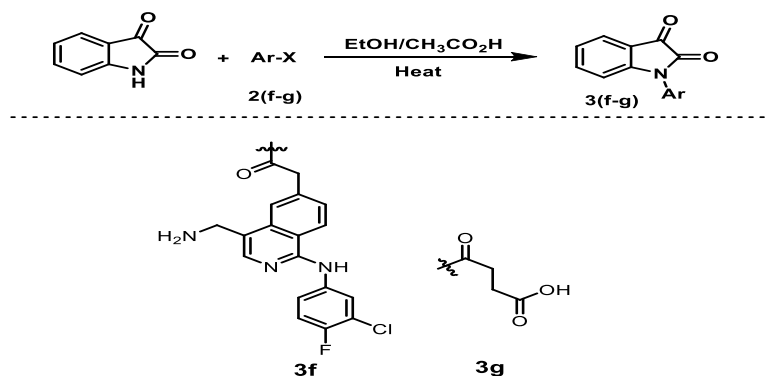
### Scheme 1



### 1.2 General procedure for the synthesis of N-acylated Isatin (3f-3g)

Equimolar quantities of Ar-X and isatins (1 mmol of each) were added in a 100 mL two necked flask containing ethanol (20 ml). Stir the reaction mass for 5-10 min and acetic acid (0.5 mol) were introduced under a nitrogen atmosphere. Then, heat the reaction mass to 65-70  $^\circ\text{C}$  for 10-12 hours. The progress of the reaction was monitored using TLC. Thereafter, cool the reaction mass to 25-30 $^\circ\text{C}$  and add ice-cold water (20 ml). Stir the reaction mass for 2 hour. Filter the solid observed and wash with water (10 ml) to obtain N-acylated Isatin (3f-3g) (a light-brown to off white powder) is obtained. The derivatives N-substituted Isatin (3f-3g) thus prepared had sufficient analytical purity. The solid was recrystallized in ethanol: water to afford the titled compounds.

### Scheme 2:





### 3.0 RESULT AND DISCUSSION

#### 3.1.0 Synthesis of 1-(1H-indazol-6-yl)-1H-indole-2,3-dione (3a)

Yield: 85.26 %; M.P.: 133-138°C; IR: 3450, 3030-3121, 2750-2880, 1760-1780, 1430-1620 cm<sup>-1</sup>;

<sup>1</sup>H-NMR (DMSO, 400 MHz) (δ ppm): <sup>1</sup>H NMR: δ 7.37 (1H, dd, J = 8.8, 1.4, 0.6 Hz), 7.39 (1H, dd, J = 7.8, 7.6, 1.4 Hz), 7.48-7.73 (3H, 7.54 (dd, J = 7.8, 1.4, 0.5 Hz), 7.73-7.93 (2H, dd, J = 8.2, 1.4, 0.5 Hz), 7.88 (dt, J = 1.4, 0.5 Hz)), 8.27 (1H, dt, J = 1.6, 0.5 Hz).. MS: Observed (m/z) 264.85 (M+)

**3.2.0 Synthesis of 1-{3-[2-(5-hydroxypyridin-2-yl)ethyl]-1H-indazol-6-yl}-1H-indole-2,3-dione (3b)** Yield: 76.98% ; M.P: 156-158°C; IR: 3500, 3420, 3020-3121, 2900-2980, 1750-1780, 1330-1690 cm<sup>-1</sup>; <sup>1</sup>H NMR (DMSO, 400 MHz): δ 3.05-3.23 (4H, t, J = 4.3 Hz), 6.99 (1H, dd, J = 8.0, 0.5 Hz), 7.17-7.47 (3H, dd, J = 7.8, 7.5, 1.4 Hz), 7.79-7.96 (5H, dd, J = 1.6, 0.4 Hz), 8.21 (1H, dd, J = 1.7, 0.5 Hz). MS: Observed (m/z) 385.15 (M+)

#### 3.3.0 Synthesis of 2-[[3-(2,3-dioxo-2,3-dihydro-1H-indol-1-yl)-3H-indazol-6-yl]sulfanyl]-N-ethylbenzamide (3c)

Yield: 68.56% ; M.P. 178-181°C; IR: 3600, 3008-3140, 2770-2960, 2260-2400, 1660-1850, 1430-1620cm<sup>-1</sup>;

<sup>1</sup>H NMR (DMSO, 400 MHz): δ 2.75 (3H, t, J = 7.1 Hz), 3.33 (2H, (q, J = 7.1 Hz), 3.34 (2H, 3.63

(d, J = 11.3 Hz), 7.0 (1H, s), 7.02-7.16 (2H, 7.01 (dd, J = 1.2, 0.5 Hz), 7.26-7.46 (3H,dd, J = 7.8, 7.3, 1.3 Hz), 7.47-8.38 (6H, dd, J = 7.9, 7.5, 1.4 Hz), MS: Observed (m/z) 455.6 (M+)

#### 3.4.0 Synthesis of 1-(2-(4(aminomethyl)-1-((3-chloro-4-fluorophenyl)amino)isoquinolin-7-yl)acetyl)indoline-2,3dione (3d)

Yield: 75.96% ; M.P. 145-147°C; IR: 3550, 2820-3110, 1750-1780, 1580-1680, 1350-1410, cm<sup>-1</sup>;

<sup>1</sup>H NMR (DMSO, 400 MHz): δ 1.15 (3H, s), 1.18 (3H, s), 1.33-1.97 (14H, dd, J = 13.0, 10.2, 6.0 Hz), 2.50-2.72 (3H, dd, J = 15.1, 7.2 Hz), 5.27 (2H, dd, J = 7.3, 7.0 Hz), 6.17 (1H, dd, J = 3.7, 1.8 Hz), 7.30 (1H, dd, J = 7.8, 7.5, 1.4 Hz), 7.70-7.86 (3H, 7.78 dd, J = 8.7, 7.5, 1.3 Hz), MS: Observed (m/z) 417 (M+)

#### 3.5.0 Synthesis of 2-(2,3-dioxo-2,3-dihydro-1H-indol-1-yl) benzene sulfonamide (3e)

Yield: 81.2% ; M.P. 205-207°C; IR: 3460-3520, 3080-3120, 1770-1790, 1450-1600, 1310-1430, cm<sup>-1</sup>;

<sup>1</sup>H NMR (DMSO, 400 MHz): δ 7.29-7.39 (2H, dd, J = 8.0, 7.5, 1.4 Hz), 7.48-7.87 (4H, dd, J = 8.7, 1.4, 0.5 Hz), 7.96 (1H, dd, J = 8.0, 1.5, 0.5 Hz), 8.32 (1H, dd, J = 8.3, 1.4, 0.5 Hz). MS: Observed (m/z) 302 (M+)

#### 3.6.0 Synthesis of 1-(2-(4(aminomethyl)-1-((3-chloro-4fluorophenyl)amino)isoquinolin-6-yl)acetyl)indolin-2,3-dione (3f)

Yield 77.8 % ; m.p: 189-192°C; IR: 3380-3430, 2980-3150, 1760-1790, 1510-1602, 1340-1410, cm<sup>-1</sup>;

<sup>1</sup>H NMR (DMSO, 400 MHz): δ 3.79 (2H, s), 3.93 (2H, s), 7.27-7.44 (4H, dd, J = 8.5, 1.7 Hz), 7.47-7.75 (4H, dd, J = 1.7, 0.5 Hz), 7.79 (1H, dd, J = 7.8, 1.3, 0.5 Hz), 8.10 (1H, dd, J = 8.3, 0.4 Hz), 8.58 (1H, d, J = 0.5 Hz). MS: Observed (m/z) 486 (M+)

#### 3.7.0 Synthesis of 4-(2,3-dioxo-2,3-dihydro-1H-indol-1-yl)-4-oxobutanoic acid (3g)

Yield 74.7 %; m.p: 154°C; IR: 3500, 3090-3130, 2960-3020, 1750-1810, 1580-1590, 1420-1470 cm<sup>-1</sup>;

<sup>1</sup>H NMR (DMSO, 400 MHz): δ 2.83 (2H, t, J = 7.5 Hz), 2.96 (2H, t, J = 7.5 Hz), 7.36 (1H, dd, J = 7.8, 7.5, 1.3 Hz), 7.58-7.74 (2H, dd, J = 8.7, 1.3, 0.5 Hz), 7.87 (1H, dd, J = 7.8, 1.3, 0.5 Hz) MS: Observed (m/z) 261 (M+)

### 3.2 Antibacterial Activity Evaluation

The antibacterial activity is performed by placing a sterile disc ingested by the control sample on a bacterial mat at the start of its growth cycle and measuring the zone where the bacteria are unable to develop. As a result, the inhibition diameter, which measures the antibacterial activity of the tested substance, is calculated. The disc diffusion method was used to test the antibacterial activity of N-alkylated and N-acetylated derivatives and results

are demonstrated in **Table 1**. The synthesised compounds perform minimal inhibitory concentration (MIC) was measured using microdilution method with slight modifications. When compared to the positive control, the lowest concentration with no microbial growth was reported as the minimum inhibitory concentration (MIC). As a negative control, DMSO (2%) was used. In a Mueller Hinton broth mixed with bacteriological agar, the isatin derivatives were diluted to a final concentration between 5 mg / ml and 0.004 mg / ml, and 50 L of bacterial culture was added to each well at a final concentration of 106 CFU / ml. Our product's ultimate concentration ranged from 5 mg ml<sup>-1</sup> (3rd well) to 0.019 mg ml<sup>-1</sup> (well 11). The plates were incubated for 24 hours at 37°C. The conversion of the blue dye resazurin to pink resorufin after 2 hours of incubation demonstrated bacterial growth.

A bactericidal control is performed 24 hours prior to the CMB by streaking on platelet agar, followed by microdilution to the broth by spreading 5 l of the negative wells on Luria Bertani agar plates (Luria Bertani medium: Yeast extract 5.0 g, peptone 10.0 g, sodium chloride 5.0 g, distilled water 1000 ml). The MBC will be the lowest concentration with a germ development rate of less than or equal to 0.01 percent of survivors after transplantation.

**Table 1.** Antimicrobial screening results of the time-tested compounds.

Compound vulgaris	E. coli	P. MRS A	B. subtilis	A. Niger	C. albicans	A. flavus	M. furfur	
3a	-	10.34	-	-	9.45	14.21	17.26	6.96
3b	9.05	-	-	-	-	-	-	10.54
3c	-	-	10.21	8.07	-	-	-	11.67
3d	12.35	-	-	10.25	10.26	16.99	11.37	10.68
3e	6.95	17.25	-	8.76	9.98	18.06	19.08	9.55
3f	20.43	20.54	21.10	26.14	12.89	16.45	26.15	11.05
3g	8.66	7.22	11.09	8.92	8.77	9.15	10.65	9.69
Chloramphenicol	25.79	24.36	22.19	27.87	NA	NA	NA	NA
Amphotericin-B	NA	NA	NA	NA	30.35	35.21	33.26	37.56

Diameter in 'mm' calculated by Vernier Caliper '-' means no zone of inhibition, NA Not applicable

### 3.2.1 Antibacterial Study

The literature found that, methicillin-resistant Staphylococcus aureus (MRSA) causes serious public and human health problems. MRSA is defined as difficult-to-treat strain of Staphylococcus aureus which resists to almost all antibiotics [11]. However, infections caused by MTSA have been a major threat to public health in hospitals and the community during the past decade. The **Fig. 1** shows that, N-Acylated derivatives of isatin behaves and act to inhibit the growth of methicillin resistant Staphylococcus aureus and Bacillus subtilis gram positive bacteria [12]. Further results demonstrate that among the all except (3b,3c) shows highest anti-fungal activity.



**Fig.1** Antimicrobial zone of inhibition

Where, (1 = 3a, 2 = 3b, 3 = 3c, 4 = 3d, 5 = 3e, 6 = 3g, 7 = 3f, 8 = 3g, 9 = Amphotericin-B standard, 10 = chloramphenicol Standard)

The isatin N-alkylated and N-Acylated derivatives showed moderate anti-bacterial activities against Gram-positive *B. subtilis* and Gram-negative *E. coli* and *P. vulgaris* pathogens. The results indicated that the hybrids with halides, thiophene ring and amide functionality of isatin moiety were more potent than the corresponding unsubstituted analogs generally, and replacement of alkyl groups with phenyl or (substituted) benzyl groups couldn't improve the anti-bacterial activity apparently [13]–[16].

### 3.2.2 Anti-Fungal Activity

All synthesized isatin derivatives were evaluated for their antifungal behaviour among the most all N-alkylated and N-acylated performs better results *Malassezia furfur* as shown in **table 1**. In a series of focused studies on all N-alkylated and N-acylated, we have found some potent activity *Aspergillus niger*, *Candida albicans*, and *Aspergillus flavus*. Our results on N-alkylated and N-acylated derivatives encouraged us to extend our studies to isatin derivatives, which could be considered as a close analog of their isatin counterparts [17]–[19]. For the isatin N-alkylated and N-acylated hybrids (3b, 3c) conjugates with pyrazole-aromatic rings showed no potent anti-fungal activity against the tested pathogenic bacteria and fungi.

### CONCLUSION

The present study highlights the importance of novel N-alkylated and N-acylated derivatives of isatin due to structural features against the antibacterial and antifungal activity. The compounds having sulphur, nitrogen, halogens and five member diazoles exhibited promising antimicrobial activity. Since, on considering the structural activity relationships for this class of compounds and analysing the contribution of different groups at N- position of isatin to the antimicrobial efficiency. The recent trends in antibiotics have contributed enormously to treat bacterial and fungal infections, but bacterial resistance appeared gradually due to the long-term, wide-ranging, inappropriate use and even abuse of antibiotics. Therefore, novel anti-bacterial agents and heterocyclic compounds with isatin functionality are desired urgently. Isatin derivatives possess a variety of pharmacological properties including anti-bacterial activity, and some of isatin-based compounds have already used for clinical deployment in the control and eradication of various diseases. Thus, isatin derivatives are reasonable choice for the development of new anti-bacterial agents.

### ACKNOWLEDGEMENT

The authors would like to express their appreciation to the R.C. Patel College of Pharmacy, Shirpur for providing necessary facilities during the work and Department of Chemistry, S.S.V.P. S, L.K.Dr.P.R. Ghogrey, Science College, Dhule for Advanced Studies in Basic Sciences for granting access to the laboratory facility.

### REFERENCES

1. J. F. M. Silva, S. J. Garden, and A. Pinto, "The Chemistry of Isatins: A Review from 1975 to 1999," *J. Braz. Chem. Soc.*, vol. 12, pp. 273–324, May 2001.
2. M. Pal, N. K. Sharma, P. Priyanka, and K. K. Jha, "Synthetic and biological multiplicity of isatin," *ChemInform*, vol. 42, no. 44, p. no-no, 2011.
3. B. Bhargu, D. Pathak, N. Siddiqui, M. S. Alam, and W. Ahsan, "Search for biological active isatins: a short review," *Int J Pharm Sci Drug Res*, vol. 2, no. 4, pp. 229–235, 2010.
4. R. P. Sonawane and R. R. Tripathi, "The chemistry and synthesis of 1H-indole-2, 3-dione (Isatin) and its derivatives," *Int. Lett. Chem. Phys. Astron.*, vol. 7, 2013.
5. A. S. Grewal, "Isatin derivatives with several biological activities," *Int. J. Pharm. Res.*, vol. 6, no. 1, pp. 1–7, 2014.
6. V. Mashayekhi, K. H. M. E. Tehrani, S. Amidi, and F. Kobarfard, "Synthesis of novel indole hydrazone derivatives and evaluation of their antiplatelet aggregation activity," *Chem. Pharm. Bull.*, pp. c12-00597, 2012.
7. U. K. Singh, S. N. Pandeya, J. Sunil, P. Manoj, B. K. Srivastava, and S. Anamika, "Synthesis and antimicrobial activity of Schiff's and Mannich bases of 1H-indole-2, 3-dione derivatives.," *Der Pharma Chem.*, vol. 2, no. 2, pp. 392–399, 2010.
8. K. Kieć-Kononowicz and E. Szymańska, "Antimycobacterial activity of 5-arylidene derivatives of hydantoin," *Farm.*, vol. 57, no. 11, pp. 909–916, 2002.
9. R. P. Bhole and K. P. Bhusari, "Synthesis and 3D-QSAR of p-hydroxybenzohydrazide derivatives with antimicrobial activity against multidrug-resistant *Staphylococcus aureus*," *J. Korean Chem. Soc.*, vol. 54, no. 1, pp. 77–87, 2010.

10. K. N. Myangar and J. P. Raval, "Design, synthesis, and in vitro antimicrobial activities of novelazetidiny-3-quinazolin-4-one hybrids," *Med. Chem. Res.*, vol. 21, no. 10, pp. 2762–2771, 2012.
11. D. S. S. M. Uppu, S. Samaddar, C. Ghosh, K. Paramanandham, B. R. Shome, and J. Haldar, "Amideside chain amphiphilic polymers disrupt surface established bacterial bio-films and protect mice from chronic *Acinetobacteanii* infection.," *Biomaterials*, vol. 74, pp. 131–143, Jan. 2016, doi: 10.1016/j.biomaterials.2015.09.042.
12. N. D. Thanh, N. T. K. Giang, T. H. Quyen, D. T. Huong, and V. N. Toan, "Synthesis and evaluation of in vivo antioxidant, in vitro antibacterial, MRSA and antifungal activity of novel substituted isatin N-(2, 3, 4, 6-tetra-O-acetyl- $\beta$ -d-glucopyranosyl) thiosemicarbazones," *Eur. J. Med. Chem.*, vol. 123, pp. 532–543, 2016.
13. Z. Xu, C. Gao, Q.-C. Ren, X.-F. Song, L.-S. Feng, and Z.-S. Lv, "Recent advances of pyrazole-containing derivatives as anti-tubercular agents," *Eur. J. Med. Chem.*, vol. 139, pp. 429–440, 2017.
14. M. Özil, E. Mentеше, F. Yilmaz, F. İslamoğlu, and B. Kahveci, "Synthesis of novel triazol compounds containing isatin as potential antibacterial and antifungal agents by microwave and conventional methods," *J. Chem. Res.*, vol. 35, no. 5, pp. 268–271, 2011.
15. A. A. Farag, "Synthesis and antimicrobial activity of 5-(morpholinosulfonyl) isatin derivatives incorporating a thiazole moiety," *Drug Res. (Stuttg.)*, vol. 65, no. 07, pp. 373–379, 2015.
16. S. Tiwari, P. Pathak, and R. Sagar, "Efficient synthesis of new 2, 3-dihydrooxazole-spirooxindoles hybrids as antimicrobial agents," *Bioorg. Med. Chem. Lett.*, vol. 26, no. 10, pp. 2513–2516, 2016.
17. M. C. Rodríguez-Argüelles, R. Cao, A. M. García-Deibe, C. Pelizzi, J. Sanmartín-Matalobos, and F. Zani, "Antibacterial and antifungal activity of metal (II) complexes of acylhydrazones of 3-isatin and 3-(N-methyl) isatin," *Polyhedron*, vol. 28, no. 11, pp. 2187–2195, 2009.
18. K. H. M. E. Tehrani et al., "Synthesis and antimycobacterial activity of symmetric thiocarbohydrazone derivatives against mycobacterium bovis BCG," *Iran. J. Pharm. Res. IJPR*, vol. 12, no. 2, p. 331, 2013.
19. K. H. M. E. Tehrani, S. Sardari, V. Mashayekhi, M. E. Zadeh, P. Azerang, and F. Kobarfard, "One pot synthesis and biological activity evaluation of novel Schiff bases derived from 2-hydrazinyl-1, 3, 4-thiadiazole," *Chem. Pharm. Bull.*, vol. 61, no. 2, pp. 160–166, 2013.

## Bio-Polymer: Carboxy-Methyl Tamarind Kernel Gum

Ritu Malik

Rajdhani College, University of Delhi, Delhi, India

### 1. INTRODUCTION

The Greener approach to the utilization of Renewable Feedstocks is a step toward a sustainable future. Scientists and researchers are eyeing, the usage of natural polymers as raw materials as they possess distinctive characteristics viz. being environment-friendly, bio-degradable, bio-compatible, cost-effective, less toxic, easily accessible, and many more. The implication of the term “bio” in biopolymers is slated for the polymers that are engendered genetically from living components. Usually, made of monomers of nucleic acids or amino acids, or saccharides, these biopolymers have the capability of polymerization with various monomers (both synthetic and natural), to form tri-dimensional heteropolymers. Tamarind kernel Gum (TKG) is one of such biopolymers. To introduce desired properties into it for its efficient application in various fields, it is chemically modified into carboxy-methyl Tamarind Kernel Gum (CMTKG), through a simple derivatization method. CMTKG, owing to its multifunctionality and various other attributes, is being progressively exploited for different applications in different fields.

The plant-derived Biopolymer TKG is a polysaccharide consisting of D-glucose, D-galactose, and D-xylose in the molar ratio of 3:2:1<sup>[1]</sup>. Derivatization of carboxymethylated form renders anionic nature to CMTKG and aids in the development of a network of hydration. The numerous enhanced attributes of CMTKG as compared to TKG include enhanced stability, boosted swelling power, high drug loading capacity, broad pH tolerance, mucoadhesion, hydrophilicity, and slow-release kinetics as depicted in Fig.1. It also reveals enhanced life-shell, low degradation, and anti-bacterial properties. Due to these beneficial aspects, it is being applied in the field of oral drug delivery<sup>[2]</sup>, medicine<sup>[3]</sup>, tissue engineering<sup>[4]</sup>, waste-water treatment<sup>[5]</sup>, and agronomy<sup>[6]</sup>.

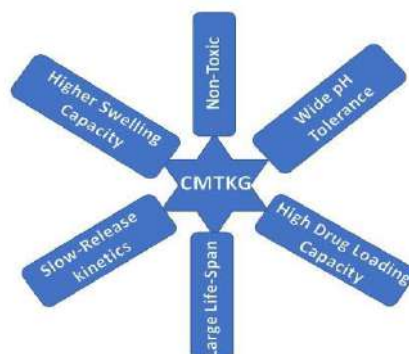


Fig.1. Various Aspects of CMTKG

### 2. SYNTHESIS OF CMTKG

Tamarind Kernel Gum, extracted from the seeds of Tamarindus Indica L, composed of Xyloglucans is the green feedstock applied in the synthesis of CMTKG.

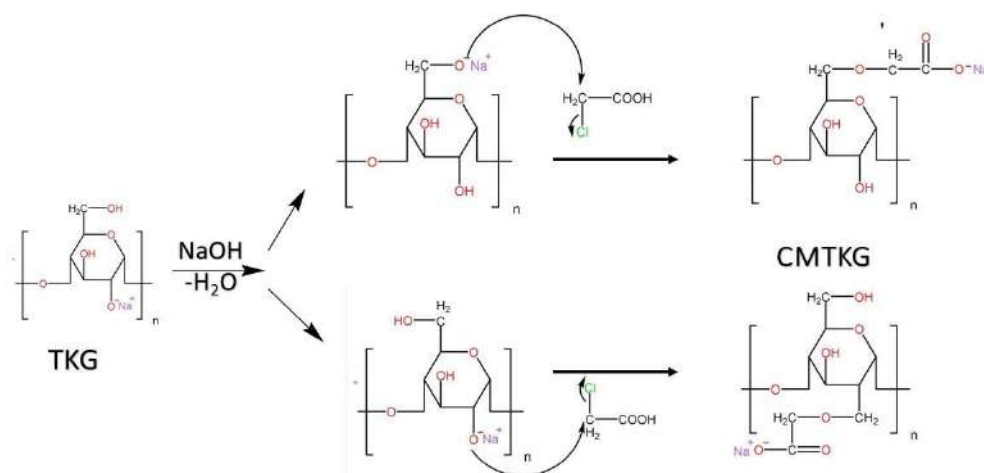
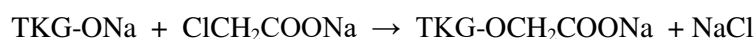
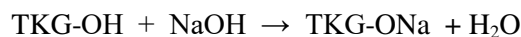


Fig.2. Mechanism of synthesis of CMTKG

Derivatization is accomplished by dissolution of TKG in aqueous alkaline methanol solution (0.15 mol of NaOH), followed by a reaction with monochloroacetic acid (MCA) (0.15 mol). The reaction is completed by keeping it in a hot water bath with a temperature maintained at 70°C for about an hour. The solution obtained is filtered on a G-3 sintered glass crucible. The residue obtained is dissolved in water and neutralized with dilute HCl (1:1 v/v). CMTKG in the solution is precipitated out with ethanol and cleaned up of the impurities by washing it first with aqueous methanol (Methanol: water:: 80:20), and then with pure methanol. The product is dried, initially at room temperature followed by vacuum dehydration in an oven at 40°C for about 4 hours<sup>[7]</sup>. Titrimetric method is usually employed to find the degree of carboxymethylation of TKG. The derivatization is a two-step process, in which sodium hydroxide converts the hydroxyl groups of TKG into alkoxide groups first, followed by Williamson's etherification (S<sub>N</sub>2 reaction) to introduce carboxymethyl groups between TKG-alkoxide and MCA.



The optimization of derivatization is done by varying various parameters viz. duration of reaction, temperature, the concentration of MCA, methanol-water ratio.

### 3. APPLICATIONS OF CMTKG

Different Bio-matrices of CMTKG have been fabricated viz. hydrogels, nano-particles, pellets, films, composites etc. and have been applied in several fields: tissue engineering (medicine, drug-delivery), wastewater treatment<sup>[5]</sup> agronomy and thickener.

#### 3.1) Tissue Engineering

The novel bio-matrices of CMTKG has been applied in Tissue Engineering.

Sanyasi et al.<sup>[8]</sup> synthesized a hydrogel from CMTKG and hydroxyethyl methacrylate and applied in the field of bone tissue engineering. The films of CMTKG loaded with drug (ciprofloxacin) revealed high microbial properties against E.coli.

Choudhary et al.<sup>[9]</sup> fabricated bio-compatible CMTKG scaffolds and applied them for skin tissue engineering.

Shaw et al.<sup>[10]</sup> synthesized drug (ciprofloxacin) loaded CMTKG based films and applied them in skin tissue engineering.

#### 3.2) Waste-Water Treatment

Sen et al.<sup>[11]</sup> synthesized novel flocculant for recycling of waste water by grafting polyacrylamide on CMTKG skeleton.

S. Pal et al.<sup>[12]</sup> synthesized CMTKG based nanocomposite which revealed high dye-absorption as well as flocculation.

C. Niu et al.<sup>[13]</sup> showed that CMTKG based bio-matrix can be effectively applied for the removal of Cu<sup>+2</sup> ions from the water.

#### 3.3) Agronomy

CMTKG has rarely been applied in agronomy. Khushbu et al. fabricated CMTKG hydrogel with sodium acrylate and applied it as a soil conditioner in the fields. Further, the same hydrogel was applied for the slow micronutrient (Boron) release.

#### 3.4) Thickener

The property as a thickener in CMTKG is exhibited due to TKG skeleton<sup>[14]</sup>.

N.R. Gupta et al.<sup>[15]</sup> grafted amino terminated poly(ethylene oxide-co-propylene oxide) onto CMTKG skeleton and applied them as thickeners in pharmaceuticals and cosmetics.

Wang et al. synthesized mixtures of CMTKG and carboxymethyl Starch (CMS) of varied concentrations and observed the mixture having higher concentrations of CMTKG, exhibited better double-sided printing effects on georgette with higher penetration and better colors.

### 4. CONCLUSION

From this article, it can be inferred that the bio-polymer CMTKG has been explored a little and due to its positive characteristics of bio-degradability, non-toxicity, abundant availability, bio-compatibility, and being green; scientists should target it's research for its efficient usage in different areas.

---

---

**REFERENCES**

1. J. Joseph, ... S. K.-... journal of green, undefined 2012, search.proquest.com
2. A. D. Kulkarni, A. A. Joshi, C. L. Patil, P. D. Amale, H. M. Patel, S. J. Surana, V. S. Belgamwar, K. S. Chaudhari, C. V. Pardeshi, *Int. J. Biol. Macromol.* **2017**, 104, 799–812.
3. A. Chilkoti, T. Christensen, J. A. MacKay, *Curr. Opin. Chem. Biol.* **2006**, 10, 652–657.
4. A. Di Martino, M. Sittinger, M. V. Risbud, *Biomaterials* **2005**, 26, 5983–5990.
5. D. Gomez-Maldonado, I. B. V. Erramuspe, M. S. Peresin, *BioResources* **2019**, 14, 10093–10160.
6. A. P. Gupta, in *J. Trace Elem. Med. Biol.*, Elsevier GmbH, **2005**, pp. 325–331.
7. P. Goyal, V. Kumar, P. S.-C. Polymers, undefined 2007, Elsevier
8. S. Sanyasi, A. Kumar, ... C. G.-C., undefined 2014, Elsevier.
9. P. Choudhury, S. Kumar, A. Singh, A. Kumar, ... N. K.-C., undefined 2018, Elsevier
10. G. Shankar Shaw, D. Biswal, I. Banerjee, K. Pramanik, A. Anis, K. Pal, *Taylor Fr.* **2017**, 56, 141–152.
11. G. Sen, S. P.-M. symposia, undefined 2009, Wiley Online Libr. **2009**, 277, 100–111.
12. S. Pal, S. Ghorai, C. Das, S. Samrat, A. Ghosh, A. B. Panda, *Ind. Eng. Chem. Res.* **2012**, 51, 15546–15556.
13. C. Niu, S. Li, F. L.-A. M. Research, undefined 2013, Trans Tech Publ
14. M. G.-F. hydrocolloids, undefined 1986, books.google.com.
15. N.R. Gupta, A. Torris A. T, P.P. Wadgaonkar, P.R.... - Google Scholar,” can be found under [https://scholar.google.com/scholar?hl=en&as\\_sdt=0%2C5&q=N.R.+Gupta%2C+A.+Torris+A.+T%2C+P.+Wadgaonkar%2C+P.R.+Rajamohanan%2C+G.+Ducouret%2C+D.+Hourdet%2C+C.+Creton%2C+M.+V.+Badiger%2C+Synthesis+and+characterization+of+PEPO+grafted+carboxymethyl+guar+and+carboxymethyl+tamarind+as+new+thermo-associating+polymers%2C+Carbohydr.+Polym.+1&btnG=](https://scholar.google.com/scholar?hl=en&as_sdt=0%2C5&q=N.R.+Gupta%2C+A.+Torris+A.+T%2C+P.+Wadgaonkar%2C+P.R.+Rajamohanan%2C+G.+Ducouret%2C+D.+Hourdet%2C+C.+Creton%2C+M.+V.+Badiger%2C+Synthesis+and+characterization+of+PEPO+grafted+carboxymethyl+guar+and+carboxymethyl+tamarind+as+new+thermo-associating+polymers%2C+Carbohydr.+Polym.+1&btnG=)

## Formulation and Evaluation of Guaifenesin Hard Candy Lozenges

Shailaja Pashikanti\*, Teja Sri Soumya Kari and G. Snehalatha

A.U. College of Pharmaceutical Sciences, Andhra University, Visakhapatnam 530003, Andhra Pradesh, India

### ABSTRACT

**Objective:** The objective of this study was to develop hard candy lozenge formulation of guaifenesin, a mucolytic expectorant, with sugar substitutes for effective management of productive cough to overcome disadvantages of guaifenesin such as poor flow properties, gastric irritation and bitter taste. These sugar free lozenges do not stimulate insulin that helps in reducing the risk factor for diabetics and also do not promote tooth cavities for young children which is a problem associated with normal sugar lozenges.

**Method:** Hard candy lozenges were formulated using heating and congealing technique by using a low-calorie sugar substitute, isomalt (Galen IQ 800) as base and hand rolled lozenges were formulated using a hand rolling technique with sucrose as sugar base.

**Results:** The optimized hard candy formulation OF1 with low plasticizer (Glycerol) concentration of 0.01% and high hydrocolloid concentration (Methyl cellulose) of 2.5% was formulated and the optimized formulation was evaluated for weight variation, % friability, hardness, thickness, moisture content, drug content, oral retention time and % in vitro drug release. Stability studies were conducted as per the ICH guidelines and finally the optimized formulations were compared to a marketed tablet and conclusion was drawn for the better dissolution rate between the lozenge and commercial tablet, hard candies were found to have more hardness stability and oral retention time.

**Conclusion:** Hard candy lozenges were better formulations than normal conventional tablet as they showed a release of 98% within 30 min.

Keywords: Isomalt, Oral retention time, Heating and Congealing, Factorial design.

### 1. INTRODUCTION

Buccal drug delivery system is a most promising route of drug delivery due to its rich vasculature and several advantages when compared to oral administration such as surpassing first pass metabolism, avoidance of pre-systemic elimination, effective drug localization in affected areas etc. [1] Lozenges are flavored medicated dosage forms intended to be sucked and held in the mouth or pharynx. They may contain vitamins, antibiotics, antiseptics, local anaesthetics, antihistamines, decongestants, corticosteroids, astringents, analgesics, aromatics, demulcents or combination of these ingredients [2]. Hard candy is a mixture of sugar and other carbohydrates that are kept in an amorphous or glassy condition. This form can be considered as solid syrup of sugars generally having from 0.5 to 1.5% moisture content. Out of all the types of lozenges hard candies are better known for their stability and oral retention time. Guaifenesin is a mucolytic expectorant that is commonly used in treatment of productive cough (cough associated with phlegm). It acts by increasing the output of phlegm (sputum) and by reducing the viscosity and adhesiveness of secretions, Guaifenesin increases the efficacy of the muco-ciliary mechanism in removing accumulated secretions from the upper and lower airway [3]. Guaifenesin suffers with various disadvantages such as bitter taste with poor flow properties causing lot of tableting problems and also results in poor flow properties causing lot of tableting problems and also results in poor patient compliance. Guaifenesin has some unwanted effects on gastric vagal receptors that cause many gastric disturbances. Commercially Guaifenesin is available as conventional tablets and sustained release formulations. It would be better to formulate guaifenesin into a hard candy lozenge to overcome all the disadvantages of the drug and have better patient compliance as the taste masking of the drug can be achieved.

### 2. MATERIALS AND METHODS

#### 2.1. Materials Used

Guaifenesin gift sample from Granules India Pvt. Ltd, Hyderabad, Methyl cellulose (OHO chemicals Pvt. Ltd), Isomalt (Galen IQ 800) (Triveni chemicals Pvt. Ltd) Glycerol (Qualigens fine chemicals Pvt. Ltd), Peppermint oil (Central Drug House Pvt. Ltd), Citric acid (Thermo Electron Pvt. Ltd), Amaranth (Thermo Electron Pvt. Ltd). These are the materials used for the preparation of Guaifenesin hard candy lozenges.

#### 2.2. Method of Preparation of Hard Candy Lozenges

**The Heating and Congealing technique [4]** : The syrupy sugar base was prepared in a beaker by dissolving isomalt in a little amount of water and was kept for heating on the hot plate till the temperature reached 150°C,



temperatures was checked throughout the process with the help of a candy thermometer. When the syrup became thick, beaker was removed from the hot plate and was let to cool till it reaches 80°C. After cooling slowly, the medicament, citric acid, polymer, color plasticizer and hydrocolloid were added with continuous stirring. Finally, peppermint oil was added at the congealing phase and the mixture was poured into pre-lubricated moulds. Moulds were kept aside for 10 min after cooling lozenges were removed from the mould and wrapped in an aluminium foil and stored in the desiccator.

**Table 1:** Formulae for preparation of Guaifenesin lozenges: (Quantity for 10 lozenges)

Ingredients (mg)	F1	F2	F3	F4	F5	F6	F7	F8	F9
Drug (mg)	2000	2000	2000	2000	2000	2000	2000	2000	2000
Isomalt (mg)	17083	17079	16983	17091	17179	17183	16987	17191	16991
Methyl cellulose (mg)	400	400	500	400	300	300	500	300	500
Glycerol (ml)	2	6	2	10	6	2	6	10	10
Citric acid (mg)	500	500	500	500	500	500	500	500	500
Amaranth (ml)	10	10	10	10	10	10	10	10	10
Peppermint oil (ml)	5	5	5	5	5	5	5	5	5
Total (gm)	20	20	20	20	20	20	20	20	20

#### 2.4 Evaluation tests for Hard Candy lozenges [5]

**2.4.1. Average weight and weight variation test:** 20 lozenges were selected and weighed collectively and individually on an electronic balance. From the collective weight, average weight was calculated. Each lozenge weight was then compared with average weight to assure whether it was within permissible limits or not. Not more than

**2.4.2.** An two of the individual weights deviated from the average weight by more than 5% for 2 g lozenge and none by more than double that percentage.

Average weight = weight of 20 lozenges / 20

% Weight variation =  $\frac{\text{Average weight of lozenges} - \text{weight of each lozenge} \times 100}{\text{Average weight of lozenges}}$

#### 2.4.3. Friability Test

The friability of the 20 lozenges from each batch was tested by a friabiliator. At a speed of 25 rpm for 4 min. The lozenges were then de-dusted, re-weighed and percentage weight loss was calculated by the equation.

% Friability =  $\frac{\text{initial Wt.} - \text{Wt. after friability}}{\text{initial. Wt.}} \times 100$

#### 2.4.4. Hardness Test

To evaluate the diametrical crushing strength, 3 lozenges from each formulation were tested using Monsanto hardness tester. The mean  $\pm$  SD values were calculated.

#### 2.4.5. Lozenge Thickness

The thickness of lozenges was measured by vernier calipers and it is a significant feature in reproducing appearance. The average thickness for lozenges was measured in mm and presented with standard deviation.

#### 2.4.6. Oral Retention Time [6]

Oral retention time was determined for each batch of formulation using USP disintegration apparatus, where lozenges were placed in each tube of the apparatus and time taken for the lozenges to retain or time taken to dissolve completely was noted by using 100 ml of simulated salivary fluid at 37 °C.

#### Preparation of Simulated Salivary Fluid

Sodium chloride (0.9 g) was dissolved in 95 ml distilled water and the volume was made up to 100 ml with human saliva. This preparation makes provision for isotonicity of actual human saliva, as well as necessary presence of resident salivary enzymes which may impact on lozenge activity in normal clinical use condition. The mixture was sterilized by autoclaving at 121 °C at 15 lb. pressure for 30 min.

#### 2.4.7. Drug Content

Lozenges were powdered and equivalent powder was dissolved in 100 ml of pH 6.8 Phosphate buffer. From this solution 1 ml taken filtered using filter paper. The absorbance was measured at 273 nm. The drug content of Guaifenesin lozenges was calculated using calibration curve.

#### 2.4.8. Moisture Content Analysis

##### Loss on Drying Method

The sample was weighed and crushed in a mortar. From this, one gram of the sample was weighed and placed in desiccators for 24 h. After 24 h the sample is weighed. The moisture content is determined by the subtracting the final weight from initial weight of lozenges.

#### 2.4.9. In Vitro Dissolution Studies

The rate of the drug absorption was determined by the rate of drug dissolution from the lozenges. Thus, the rate of dissolution and bioavailability may be directly related to the efficacy of the lozenge. The USP type II dissolution apparatus was used and the dissolution medium was pH 6.8 phosphate buffer, 900 ml was placed in the beaker containing the lozenges and stirred at 50 rpm. 5 ml aliquot samples were withdrawn at 5 min. interval and replaced immediately with an equal volume of fresh buffer. Each aliquot was diluted and they were analyzed at 273 nm, by UV Visible spectrophotometer.

#### 2.4.10. Stability Study [7]:

Accelerated stability study was carried out as per ICH guidelines Q1A (R2). The optimized formulation was wrapped in aluminium paper and was sealed. It was stored at accelerated ( $40^{\circ}\text{C} \pm 2^{\circ}\text{C} / 75\% \text{RH} \pm 5\% \text{RH}$ ) condition for a period three months. After every month lozenges were evaluated for drug content, weight variation, colour, hardness and moisture content.

#### 2.4.11. Comparison of Lozenges With Marketed Conventional Tablets

Optimized formulation was compared with normal marketed tablets of Guaifenesin (Cervclear tablets manufactured by Forts India Laboratory).

#### Specifications of Commercial Guaifenesin

**TabletName:** Guaifenesin tablet I.P

**Strength:** 200 mg

**Brand name:** Cervclear

**Company:** Forts India laboratory

**Weight:** 200 mg

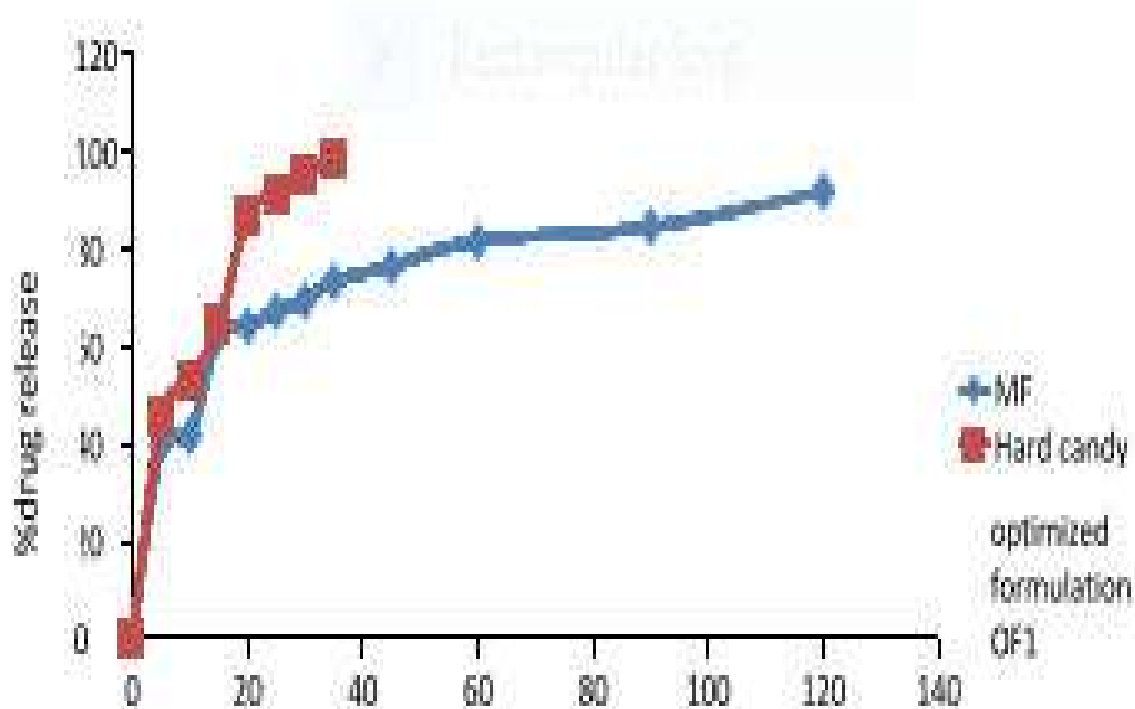


Figure 1: Comparative dissolution graph of hard candy lozenges vs Cervclear tablets

Time (Sec)

### 3.0. Evaluation Test Results

#### 3.1. FT-IR Results For Impurities

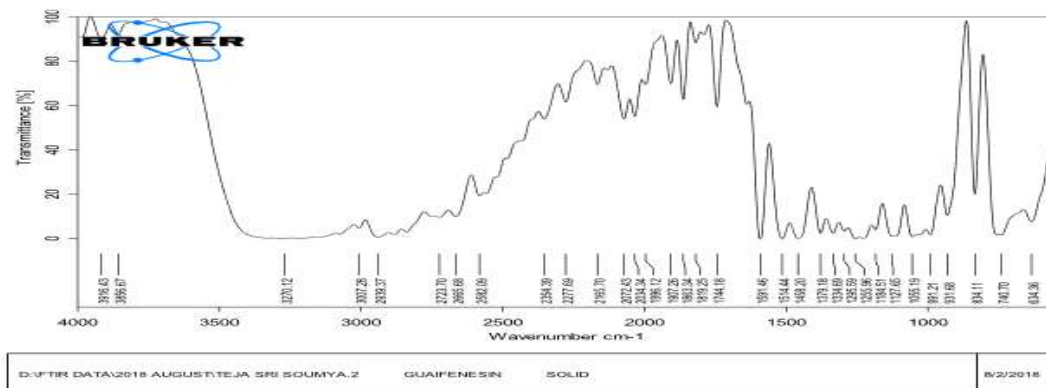


Figure 2: Guaifenesin FT-IR Result

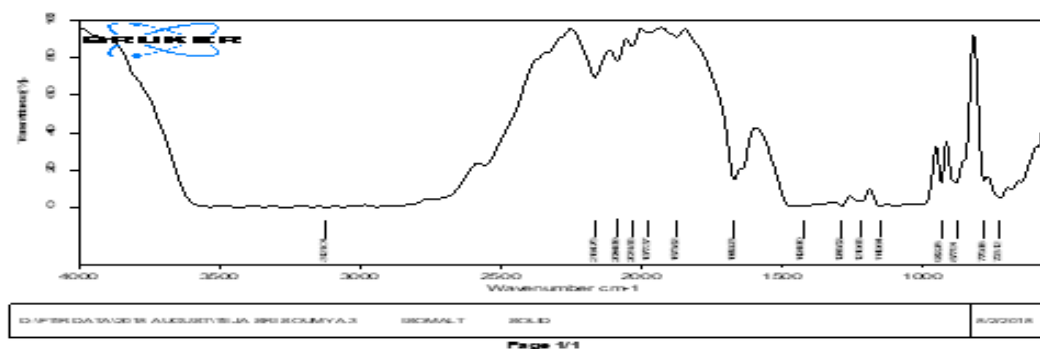


Figure 3: Isomalt FT-IR Result

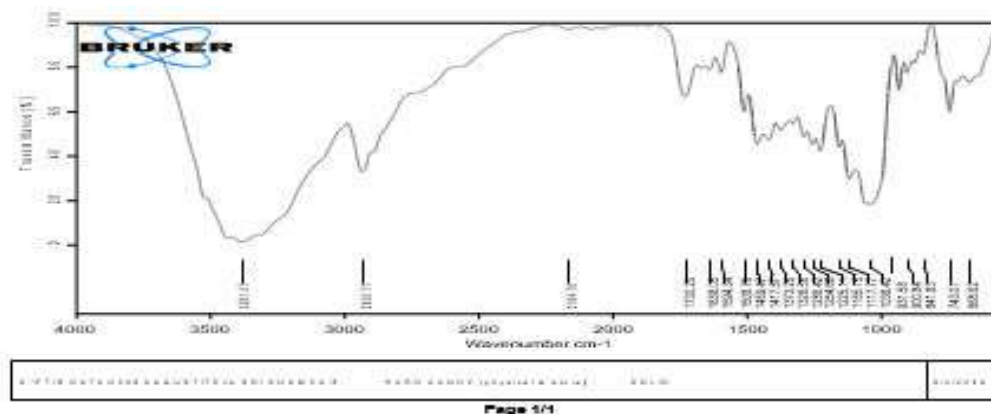


Figure 4: Physical mixture of hard candy lozenges

#### 3.2. Physical Evaluation Tests for Hard Candy Lozenges

Table 2.0: Evaluation tests for hard candy lozenges formulations

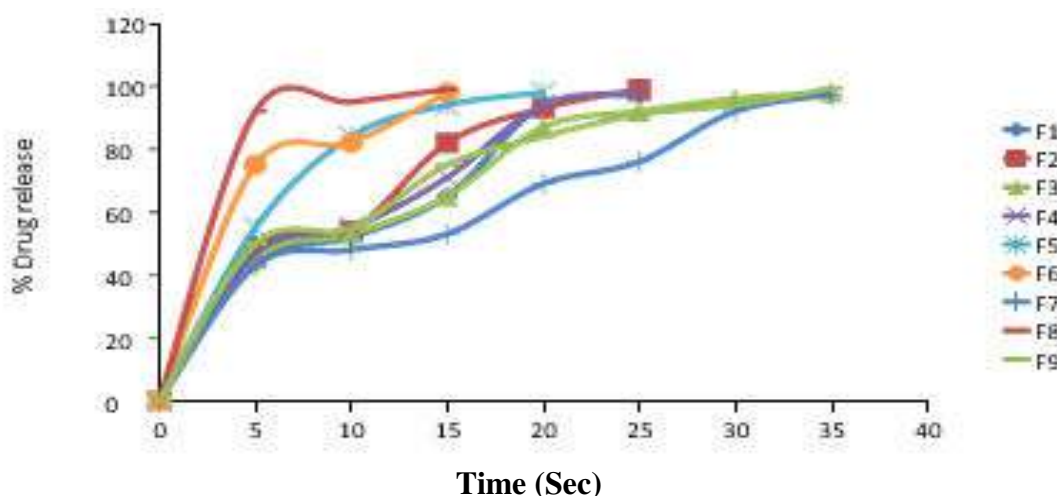
Formulation code	Hardness Kg/cm <sup>2</sup>	Thickness (mm)	Weight variation%	% Friability	Oral retention (min)	% Drug content	Moisture content analysis %
F1	11.84±0.05	3±0.01	2.21±0.002	0.69±0.01	15±0.05	96.7±0.05	0.053±0.01
F2	8.93±0.05	3.1±0.05	2.03±0.005	0.23±0.028	20±0.002	99.3±0.05	0.27±0.06
F3	12.05±0.02	2.9±0.05	2.18±0.1	0.5±0.05	27±0.02	98.3±0.02	0.05±0.08
F4	7.35±0.08	3.1±0.02	2.09±0.03	0.73±0.01	21±0.1	97±0.4	0.86±0.05
F5	9.53±0.05	3±0.002	2.06±0.02	0.4±0.02	12±0.05	97.8±0.02	0.28±0.01
F6	11.98±0.02	3.07±0.03	2.15±0.05	0.1±0.08	10±0.05	98.5±0.25	0.055±0.02

<b>F7</b>	9.37±0.05	3.12±0.02	2.23±0.08	0.48±0.01	26±0.05	97.2±0.17	0.23±0.05
<b>F8</b>	7.48±0.02	3.05±0.002	2.08±0.002	0.28±0.01	11±0.02	98.5±0.02	0.88±0.06
<b>F9</b>	7.46±0.005	3.13±0.05	2±0.02	0.29±0.01	25±0.02	98.3±0.02	0.84±0.02

All values are expressed as mean±SD, n=3

**Table 3.0:** In vitro dissolution studies of Hard candy formulations F1 to F9.

Time(min)	% Drug released								
	F1	F2	F3	F4	F5	F6	F7	F8	F9
5	43.70	49.10	45.11	46.91	54.78	75.375	43.08	91.68	50.06
10	51.75	53.71	52.53	54.9	84.37	82.125	48.20	94.5	54.90
15	65.25	81.56	64.68	71.43	93.93	98.4375	53.43	98.66	75.37
20	93.9	92.81	86.62	93.93	97.8	-	69.18	-	84.37
25	96.7	99.33	91.68	98.78	-	-	76.5	-	91.12
30	-	-	95.62	-	-	-	92.25	-	93.93
35	-	-	98.43	-	-	-	97.31	-	99.33



**Figure 5:** % Combined dissolution profiles of hard candy lozenge formulations from F1 to F9

**Table 4.0:** Evaluation tests of optimized formulation OF1.

Formula code	Hardness Kg/cm <sup>2</sup>	Thickness (mm)	Weight variation %	% Friability	Oral retention (min)	Drug Content %	Moisture content analysis %
<b>OF1</b>	12±0.02 kg/cm <sup>2</sup>	3.07±0.005 mm	0.95±0.002 %	0.35±0.055 %	25±0.008 min	98±0.05 %	0.045±0.138 %

All values are expressed as mean ±SD, n=3.

**Table 5.0:** Stability test for optimized formulation of hard candy lozenges.

Evaluation parameters	Time period			
	0 day	1 <sup>st</sup> month	2 <sup>nd</sup> month	3 <sup>rd</sup> month
<b>Organoleptic examination</b>	No Change	No Change	No Change	No Change
<b>Hardness</b>	12±0.002 Kg/cm <sup>2</sup>	12±0.005 Kg/cm <sup>2</sup>	11.98±0.0028 Kg/cm <sup>2</sup>	11.95±0.001 Kg/cm <sup>2</sup>
<b>Weight variation</b>	0.95±0.002%	0.95±0.002%	0.94±0.0028%	0.94±0.005%
<b>% Friability</b>	0.35±0.055%	0.35±0.05%	0.34±0.002%	0.33±0.106%
<b>Oral retention time</b>	25±0.008 m	25±0.005 m	24±0.0028 m	24±0.005 m
<b>Drug content</b>	98±0.006%	98±0.0028%	97.5±0.008%	97±0.007%
<b>Moisture content</b>	0.045±0.138%	0.045±0.002%	0.046±0.001%	0.05±0.213%

(mean±SD, n=3)

### 3.3. Kinetic Plots

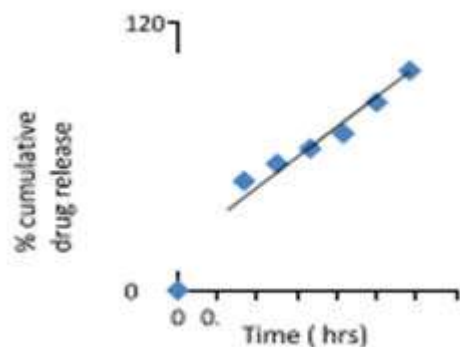


Figure 6: Zero order Plot

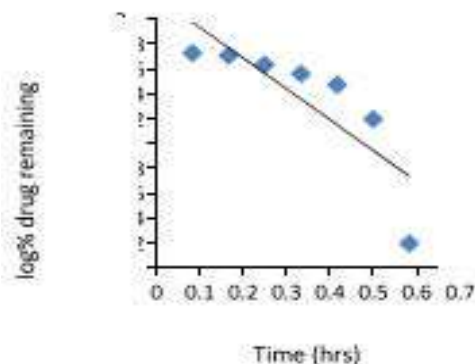


Figure 7: First Order Plot

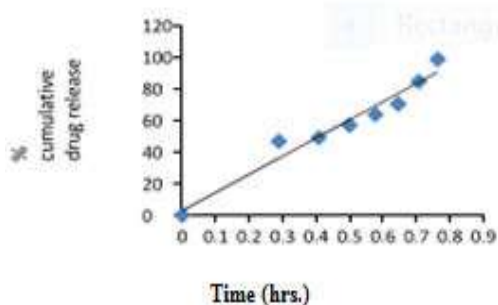


Figure 8: Higuchi Curve

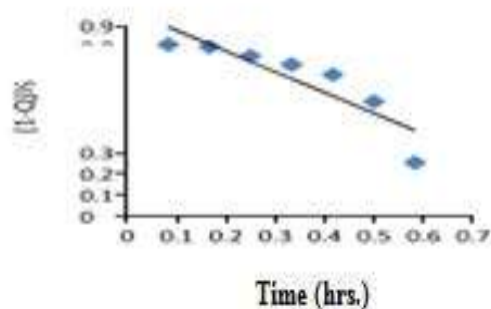


Figure 9: Hixon Crowell Plot

#### Kinetic Model Transport for Hard Candy and Hand Rolled Lozenges

Different release characterization models were applied to data obtained from *in vitro* studies. The kinetic plots for optimized formulation OF1 were represented in **Figure 6 to Figure 9**. The hard candy lozenges followed zero order kinetics because the correlation coefficient for plot was higher when compared to first order and it followed diffusion model kinetics because Higuchi plot got higher correlation coefficient and linearity when compared to other plots it was 0.955.

## 4. DISCUSSION

**4.1 FT-IR Studies:** Infrared spectra for pure drug, Isomalt, and physical mixture were determined to find the compatibility of the drug in the mixture using FTIR-Spectrophotometer by KBr pellet method. The FTIR were performed and the spectra obtained are represented from **Fig 2 to Fig 4**, and no incompatibilities were found.

#### 4.2 Evaluation Tests for Hard Candy Lozenges<sup>[8]</sup>:

The prepared hard candy formulations were tested with various evaluation procedures such as organoleptic examination, hardness, weight variation, friability, thickness, moisture content, oral retention time, drug content, % *in vitro* drug release the results obtained were summarized in **Table 3 to Table 4**. All the formulations were meeting the requirements as per official standards. It was observed that all the lozenges with lower glycerol content had more hardness values which was a suitable result and the lozenges with higher methyl cellulose concentration showed more oral retention time that helps the lozenge to improve localized effect of drug and its bioavailability. The evaluation tests for optimized formulation OF1 were summarized in **Table 4** it showed a maximum hardness of 12 kg/cm<sup>2</sup> a better oral retention time of 25 min and a very minimum moisture content of 0.04% that was fulfilling stability criteria.

**Stability Studies of lozenges:** For a period of three months the formulations were tested for all the evaluation parameters. The results for stability studies on hard candy lozenges were given in **Table 6**. There was not much significant difference in the lozenges parameters that were evaluated.

### Comparison with Marketed Formulation

The optimized formulations OF1 was compared with the normal conventional commercial Guaifenesin tablets for *in vitro* dissolution the dissolution profile was represented in the Figure 1. The maximum drug release of marketed tablet was about 91.6% in 2 h this may be due to the higher amount of lubricants used during tableting process to overcome poor flow properties of Guaifenesin. Whereas lozenges showed a better release of 98% in a maximum of 30 min this is beneficial because we can localize the drug before its elimination.

### 5. CONCLUSION

Taste masking, stability enhancement and oral retention of drug are the current area of research. Increased drug retention increases the oral bioavailability and effective localization of drug was achieved in affected throat tissues. Gastro intestinal side effects of the drug can also be reduced. It was observed that the hard candies showed a better oral retention time, hardness and stability and drug release than and marketed tablet. Thus, by this work, we could conclude that lozenges can be used as efficient means of formulation to enhance palatability, oral retention and localization and avoiding tableting problems with drugs.

### 6. ACKNOWLEDGEMENT

I sincerely acknowledge my university for providing me all facilities in fulfilling my research work.

### 7. REFERENCES

1. Ramasamy N, Gopal V. Mucoadhesive Buccal Drug Delivery System-A Comprehensive And Promising Novel Drug Delivery. *International Journal of Pharmaceutical Sciences and Research*. 2014 Apr 1; 5(4):1146.
2. Pothu R, Yamsani MR. Lozenges formulation and evaluation: A review. *IJAPR*.2014; 1:290-4.
3. Deng S, Huang W, Ni X, Zhang M, Lu H, Wang Z, Hu J, Zhu X, Qiu C, Shang D, Zhang Y. Pharmacokinetics of guaifenesin, pseudoephedrine and hydrocodone in a combination oral liquid formulation, administered as single and multiple doses in healthy Chinese volunteers, and comparison with data for individual compounds formulated as Antuss®. *Xenobiotica*. 2017 Oct 3; 47(10):870-8.
4. McNally D, Simpson M, Morris C, Shephard A, Goulder M. Rapid relief of acute sore throat with AMC/DCBA throat lozenges: randomized controlled trial. *International journal of clinical practice*. 2010 Jan 1;64(2):194-207
5. Nagoba SN, Rao KP, Sameer S, Gujrati DS, Nagoba BS. Studies on candy-based Ketoconazole Pediatric Tablet Lozenges. *Int J Res Ayurveda Pharm*. 2011; 2(1):239- 43.
6. Esimone CO, Okoye FB, Odimegwu DC, Nworu CS, Oleghe PO, Ejogha PW. In vitro antimicrobial evaluation of lozenges containing extract of garlic and ginger. *International Journal of Health Research*. 2010; 3(2):105-10.
7. Vidyadhara S, Sasidhar RL, Deepti B, Wilwin E, Sowjanyaalakshmi B. Formulation and Evaluation of Amoxicillin Trihydrate Lozenges. *Dhaka University Journal of Pharmaceutical Sciences*.2015; 14(1):61-70.
8. Vidyadhara S, Sasidhar RL, Deepti B, Wilwin E, Sowjanyaalakshmi B. Formulation and Evaluation of Amoxicillin Trihydrate Lozenges. *Dhaka University Journal of Pharmaceutical Sciences*.2015; 14(1):61-70.

---

---

## A Review on Leadership Vs Management

**N. Shesha Malini**

Lecturer in Department of Commerce, Hindustan College of Arts and Science, Chennai, Tamil Nadu, India

### **ABSTRACT**

Different people have used management and leadership in different ways. While some people use them interchangeably, others see them as two distinct words. The majority, on the other hand, recognizes certain similarities and distinctions between them. The goal of this investigation is to see if management and leadership are effective. Are they distinct? The conclusions of this investigation revealed that management and leadership are important. They are two completely different functions. Although management and leadership have certain similarities, many similar responsibilities that include interacting with people and persuading others to do something. Organizational management abilities are used to plan, construct, and direct the organization. Mechanisms to achieve missions and goals, and leadership abilities to keep people focused. Establishing direction, aligning individuals, and persuading and inspiring people on a prospective shift are inspirational.

Keywords: Management, Leadership, Skills, Differences

### **AN OVERVIEW**

Some managers do not exert leadership, and some people lead without holding any management responsibilities, hence it is a common misconception that all managers are leaders. As a result, there is ongoing debate concerning the distinction between leaders and managers. Although management and leadership overlap, some scholars contend that they are not the same thing (Bass, 2010). In addition, the degree of overlap is a topic of contention (Yukl, 1989). In fact, some people regard them as polar opposites, believing that a strong leader cannot be a successful manager and vice versa (Ricketts, 2009).

Leadership and management include a distinct set of tasks or responsibilities.

While leaders and managers have certain parallels in that they both use specialised powers to influence others in order to achieve specific goals, they also have some significant variances (Northouse, 2007). While managers keep the workplace running smoothly, leaders put the current position to the test and stimulate new functions, therefore they are looking for long-term objectives (Yukl, 1989). For optimal performance in today's fast-paced workplace, organisations require both efficient management and effective leadership (Kotterman, 2006). The fundamental definitions of leadership and management, as well as the specific sorts of skills required of managers and leaders, will be discussed in this review article, as well as the parallels and contrasts between management and leadership.

### **Paper Issues**

What is the difference between management and leadership?

### **The Purpose of the Paper**

To investigate if leadership and management are the same or different

### **ANALYSIS METHODOLOGY**

The following electronic databases were used to conduct a thorough literature search: EBSCO, EMBASE, and Google Scholar. The goal of the search was to find all previous papers that highlighted the distinctions between management and leadership. There was no time constraint, but the study was limited to English-language papers exclusively. The title should include the terms "management" and "leadership." The research used the keywords and phrases (leadership) and (management), or (differences), or (similarities). This review looked at original and peer-reviewed literature.

The search turned about 231,000 articles about management and leadership. After removing the duplicates, there were 25,700 items left. replicated throughout the three databases and on Google Scholar. The eligibility and relevancy of the identified articles' titles and abstracts are examined. Only 200 articles were chosen from the 25,700 that met the search criterion by including both "management" and "leadership" phrases. Inside the title finally, 37 articles were considered for our review due to their high quality. Original, peer-reviewed content

---

---

**Embase, Google Scholars, Ebsco 2,31,000 Articles**

- Excluded the Duplicated Articles- 25,700 Articles
- Excluded Articles which do not meet the Inclusion criteria – 200 Articles
- Non- Original / Peer reviewed Articles were excluded – 37 Articles

**FINDINGS/RESULTS**

The bulk of authors in a review of literature attempted to uncover distinctions by comparing management and leadership in terms of definition and abilities. The terms management and leadership shall be defined in this paper. First, the manager and leader's skills were discussed, followed by the manager's and leader's needs, and finally the manager's

**MANAGEMENT**

Leadership is a multifaceted, complex phenomenon (DePree, 1989). It's been a while a process; a responsibility; an experience; a behaviour; a style; a skill; a procedure; a responsibility; an experience; a management role; a position of authority; a connection of influence; a quality; and an aptitude (Northouse, 2007). Leadership was characterised by John Maxwell as persuasion (Maxwell, 1998). "Leadership is the ability for change," according to Kotter (1990). "to revitalise collective activity" Effective leadership, according to Robert Greenleaf, is characterised by people who follow others while serving them (Bennis and Nanus, 1997). Furthermore, Peter A leader, according to Drucker, is someone who has followers (Drucker, 1999). However, some theorists consider leadership to be a type of social influence mechanism. (1997, House and Aditya). Although there are many different definitions of leadership, majority.

The focus of leaders is on motivation and inspiration (Kotter, 1990). Leaders want to inspire others to follow their vision, set long-term goals, and take risks in order to achieve them. similar objectives, and challenge the status quo (Bennis and Nanus, 1997). The People follow the leader because he keeps an eye on his followers' benefits. voluntarily, and the leader uses a transformative method to direct the follower (Bass, 1990). Integrity, vision, and tenacity are essential attributes for leaders. selflessness, creativity, risk-taking, toughness ability to communicate and visibility (Capowski, 1994). Furthermore, leaders must have charisma; a sense of purpose; the ability to influence others in a favourable way; and problem-solving abilities (House, 1977).

Furthermore, research shows that common behaviours and characteristics such as confidence, service mentality, good coaching skills, reliability, expertise, responsibility, good listening skills, and being a good leader are all important. visionary; realistic; clear sense of priorities; honesty; readiness to contribute; high self-esteem; technical or contextual expertise; and recognition (Bennis and Nanus, 1997).

**LEADERSHIP**

Katz (1955) defined management as "executive, administrative, and supervisory positions that exercise direction over a group or organization." Management tasks, according to Katz, are usually task-oriented and include training personnel, mentoring high-potential individuals, and resolving disagreements while maintaining ethics and discipline (Katz, 1955). According to Kappa, the goal of effective management is to provide community services in an efficient and long-term manner (Kappa, 1991). Furthermore, Kotter described management as a position that is responsible for the planning, organising, budgeting, coordinating, and monitoring of operations for a group or organisation (Kotter, 2001). Northouse described management as a process through which certain goals are met by making efficient use of resources (Northouse, 2007). As a result, management in general. distinctions between management and leadership

**Management Vs Leadership**

Leadership and management are similar but not identical (Kotterman, 2006). Influence, collaboration, and achieving common goals are all aspects of leadership and management (The Guardian, 2013). Leadership and management, on the other hand, are thought to be completely separate fields (Kotterman, 2006). According to Katz, leadership is a two-way influence connection, whereas management is a one-way authority relationship (Katz, 1955).

Abraham Zaleznik published the first scholarly and seminal study on the distinction between leaders and managers in 1977. (Zaleznik, 1977). Zaleznik stated that the organisation requires both competent managers and effective leaders to achieve its objectives, but that managers and leaders contribute differently (Zaleznik, 1977). Managers encourage stability, wield authority, and seek to get things done, whereas leaders promote change, innovative ways, and work to understand people's beliefs in order to acquire their commitment. As a result, different types of people are required for management and leadership (Zaleznik, 1977).



Watson noted in 1983 that managers are concerned with structure and procedure, but leaders are concerned with communication, inspiration, and shared goals. In addition, Watson stated that leaders are more effective than managers when using the 7S strategy, which includes strategy, structure, systems, shared values, skills, and style. Bryman went on to say in 1985 that leadership is about strategic motivation. In one line, Bennis and Nannus (1985) summarise the distinctions between leaders and managers: "Leaders do the right things; managers do the right things." (p. 33). Furthermore, Bennis declared in 1989 that "we will need a new generation of leaders to survive in the twenty-first century."

- Not managers, but leaders The distinction is significant. Managers yield to the context, which is the dynamic, chaotic, unclear environment that often seems to conspire against us and will surely smother us if we let it."

### Comparison between Manger and Leader

Process	Management	Leadership
Vision	<ul style="list-style-type: none"> <li>Plans and budgets</li> <li>Develop processes and set timelines</li> </ul>	<ul style="list-style-type: none"> <li>Establish the strategic direction and refines the vision</li> </ul>
Human Development	<ul style="list-style-type: none"> <li>Delegate responsibility</li> <li>Implement the vision</li> <li>Display low emotion</li> <li>Limit employee choices</li> </ul>	<ul style="list-style-type: none"> <li>Align the organization to vision</li> <li>Communicate the vision, mission, and strategic direction</li> <li>Display driven, high emotion</li> <li>Increase choices</li> </ul>
Execution	<ul style="list-style-type: none"> <li>Control processes</li> <li>Identify problems, and solutions</li> <li>Monitor results</li> <li>Take a low-risk approach to problem-solving</li> </ul>	<ul style="list-style-type: none"> <li>Motivate and inspire</li> <li>Aim to satisfy basic human needs</li> <li>Take high-risk approach to problem-solving</li> </ul>
Outcome	<ul style="list-style-type: none"> <li>Provide expected results to leadership and other stakeholders.</li> </ul>	<ul style="list-style-type: none"> <li>Promote useful and drastic changes</li> </ul>



### AUTHORS PERSPECTIVE

From my perspective, I believe that some people are capable of performing both leadership and management functions. Leaders, in my experience, Managers were in charge of implementing the new modifications. New, though, Because implementing changes is difficult, managers may be hesitant to do so. changes. Furthermore, I completely agree with those who call for a balance between the two. Managerial and leadership responsibilities are critical to achieving the greatest results. Furthermore, I feel that leadership is becoming increasingly important in every company, particularly in the public sector. To cope with the rapid changes and diverse needs in the corporate world, this is required century.

## CONCLUSIONS

Managers and leaders are required in every organisation, and their jobs should be considered as complementary. An organization's maximum efficacy can only be achieved if it has strong leadership and management. Leaders are needed in today's changing workplace to deal with new issues and alter firms in order to gain a competitive advantage in the marketplace. Organizations also require managers to keep the workplace running smoothly and to make optimal use of resources. Finally, in order to flourish, a well-balanced organisation should contain a mix of leaders and managers (Kotterman, 2006).

## REFERENCES

1. The Guardian. (2013). what's the difference between leadership and management?. Available at <http://careers.theguardian.com/difference-between-leadership-management>
2. Lunenburg, F. C. (2011). Leadership versus Management: A Key Distinction—At Least in Theory. *International Journal of Management, Business, and Administration*, 14 (1), 1-4.
3. <https://www.peplematters.in/article/leadership/management-or-leadership-two-sides-of-the-same-coin-23067>
4. <https://www.lifehack.org/674254/leadership-vs-management-is-one-better-than-the-other> Kotterman, J., (2006), "Leadership vs Management: What's the difference?", *Journal for Quality & Participation*, Vol. 29 Issue 2, p.13-17

## Heavy Metals Accumulations (Mn, Zn and Cd) of *Lantana camara* for the Phytoremediation of Contaminated Soils

K. Sanghamitra

Department of Chemistry, Aarupadai Veedu Institute of Technology, VMRF, Paiyanoor, Chennai-603104

### ABSTRACT

Contamination with heavy metals is an acute threat to both the environment and health of human beings. Phytoremediation, or the use of plants to restore a polluted environment, is a new and promising green alternative to traditional physical and chemical approaches. Native plant species, such as weeds, grow rapidly on metal-contaminated soils and have the ability to captivate high metal concentrations with a unique tolerance, making them suitable candidates for phytoremediation of contaminated soils.

The purpose of this study was to see if the weed species *Lantana camara*, which grows naturally in the field near Visakhapatnam, A.P., India, might accumulate heavy metals. Metal build up was shown to be heterogeneous, varying amongst plant tissues such as root and shoot. At diverse sites, such as control, commercial, and industrial, metal concentrations of Zn, Mn, and Cd changed with seasons. Zn concentrations ranged from 6.1 to 133.2  $\mu\text{g/g}$  in roots and 23 to 643.5  $\mu\text{g/g}$  in shoots, Mn concentrations ranged from 10.2 to 61.27  $\mu\text{g/g}$  in roots and 31 to 120  $\mu\text{g/g}$  in shoots, while Cd concentrations ranged from non-detectable to 11.95  $\mu\text{g/g}$  in roots and 16.44  $\mu\text{g/g}$  in shoots. The Bioconcentration factor (BCF) of root and shoot for the metals Zinc(Zn), Manganese(Mn), and Cadmium(Cd), as well as the Translocation factor (TF) of the test species for these metals being  $>1$ , indicate that hyperaccumulation is a possibility. The findings imply that the weed species' ability to store and transport metals, as well as its tolerance to metal-polluted conditions, indicating that it has potential for soil phytoremediation.

**Keywords:** *L.camara*, phytoremediation, BCF, TF and heavy metals.

### 1. INTRODUCTION

Among the pollutants in the environment, heavy metals are a major source of worry. Almost every human activity has the possibility to accord to the production of the heavy metals as a by-product. These toxins spread through the soil as dust or leachates, contaminating ecosystems (Gaur and Adholeya, 2004). The sewage sludge containing heavy metals also migrate into areas which are not contaminated as leachates or dust.

There are different procedures for the elimination of harmful metals from the degraded environment, be that as it may, the green technology phytoremediation has developed as an eco-accommodating, proficient, and exquisitely satisfactory method (Wei et al., 2002). However ongoing examinations have shown recognizable proof of eatable and verdant vegetables for phytoremediation uses isn't reasonable as they apply direct harmful impacts to people and other living organisms on entering into the food chain (Kumar Narendra, et al., 2013). Weed species are a fair choice for metal uptakes as these intense receptive species can fill in most vicious circumstances over vast areas and give a huge quantity of biomass. It is essential to use nearby or local plants as they are consistently better in perseverance, development and reproduction. The current study targets to recognize metal accumulator weeds and a hyperaccumulator developing normally on polluted soils to evaluate its prospective in phytoremediation.

### 2. MATERIALS AND METHODS

#### 2.1 Description of the Site

The sampling locations were chosen based on the influential areas, core areas and activities, i.e. an industrial site (Hindustan Zinc Ltd), a commercial site (in the city centre with a lot of commercial activity), and a control site (University) during all four seasons, i.e. winter, summer, northeast monsoon, and southwest monsoon. *Lantana camara*, a weed species, was randomly gathered in replicates of five from the various sites of sampling in the city of destination Visakhapatnam.

The plants were harvested by uprooting in reproduces of five after which they were taken to the laboratory and washed thoroughly with fresh water followed by deionised water to wipe out the unnecessary matter. The plant material was detached into two portions the shoot and root, then dried at 65°C for 72 hours in an oven (Xian and Shokohifard, 1989). The dried materials were ground and kept in a dessicator for chemical analysis.

## **2.2 Analysis of Physiochemical parameters in soils and determination of heavy metals in soils and the plants species**

Standard methodologies were used to examine the physical parameters of soils, as well as the chemical parameters of soil and plant material (APHA, 1989, Sims and Heckendorn, 1991, Stewart, 1974, ICAR, 1997, Ovington, 1963). The biomass and studies on growth of the species have been conducted. All of the chemical reagents used were of high quality, and the double deionised water was used throughout the experiment. Atomic Absorption Spectrophotometer (AAS ZEE nit 700 # 150Z 70222) was used to measure heavy metals in soils and the weed species.

For metal analysis, 0.5 g of the air and oven dried soil and plant samples were obtained, mixed in a long necked flask (Kjeldahl flask) with a mixture of 5 ml of 60 percent HClO<sub>4</sub>, 10 ml of Con.HNO<sub>3</sub>, and 0.5 ml of H<sub>2</sub>SO<sub>4</sub> progressively over moderate heat increasing subsequently using the Mixed Acid Digestion method (Stewart, 1974). After the white fumes appeared, the process was continued for 10-15 minutes, cooled and double deionised water was added, and separated using the filter paper (Whatman No.44) and diluted to 50 ml with DDW. Also a blank was prepared in the same manner. The metals were measured using the AAS instrument.

### **2.3 BCF and TF**

The bioconcentration factor (BCF) shows the viability of the plant to gather the toxin in its tissues. It is determined as the proportion of the toxin in the reaped plant to that of the soil (Wu, et al., 2018; Zhuang, 2007).

BCF = Metal concentration in roots/shoots

Metal concentration in the soil

The translocation factor (TF) addresses the plant's capacity to move the contamination from the roots to the aboveground parts and is determined as shoot to root ratio (Zhuang, 2007; Zacchini, 2009; Gupta, 2008).

TF = Metal concentration in plant shoots

Metal concentration in plant root

## **3. RESULTS AND DISCUSSIONS**

### **3.1. Characteristics of Physiochemical parameters and metal accumulations in the soils**

The pH values were in the range of 5.778 to 6.976 at the industrial site. The lower pH values during winter at this site were because of the industry activities and the highest were shown during north east rainy season (Table 1). The results of the industrial site for conductivity fluctuated from 0.193 to 0.336 ms/cm shows enough dissolved solids and ionic matter, the least seen during the north east rains and the most elevated during winter (Table 1). The range of organic matter varied from 2.76 to 11.06, the most minimal revealed during summer and most noteworthy during the southwest rains. The high quantities during southwest rainy season are because of high litter, defoliation, its quicker decomposition, animal faeces, other biological debris from the foliage (Table.1). The values of nitrate-nitrogen fluctuated from 0.032 to 0.194 mg/100g at the industrial site, the most reduced recorded was during summer and the most noteworthy during the north east rainy season (Table 1). The values of nitrates are low because of the transformation of nitrates into nitrites by the soil microbes. The values of phosphorus at the commercial site were maximum and fluctuated in the range of 0.056 and 0.202 mg/100g. The nitrates and phosphorus are deficient in soil samples since the plant species utilize enormous quantities for the development and sustenance and particularly the nitrate deficiency is because of the transformation of nitrate nitrogen to nitrites by microbes of the soil. The potassium levels were viewed as the least at the control site and the maximum and same as the commercial and industrial sites (Table 1). The levels of potassium at the industrial site were in the range of 16.96 and 50.21 mg/100g, The significant levels during north east rains at the commercial site is because of the infiltration from the groundwater close to septic tanks during downpour and high excreta from various other points.

The statistical investigation has shown that the soils pH related to the weed species has not shown any huge distinction with the seasons ( $p=0.249$ ) yet a huge contrast with locations ( $p=0.000$ ) by two-way ANOVA. The contrast within the sampling locations is because of the pH in acidic range at the contaminated or industrial site contrasted with different sampling locations. The soil conductivity in comparison to the test species has shown no huge seasonal distinction ( $p>0.05$ ) yet noticeable contrast with destinations ( $p=0.007$ ). The distinction with locations is due to the huge quantities at the contaminated (industrial) site when contrasted with different locales. The nitrate-nitrogen content of the soils related to the weeds have shown a noteworthy contrast with seasonal variation ( $p=0.026$ ) yet a huge distinction with locales is not observed ( $p=0.935$ ). The potassium and phosphorus contents of the soils haven't show any noteworthy difference with the seasonal variation and

locations ( $p > 0.05$ ). This is on the grounds that the quantities didn't show a significant change and in some cases the same (Table 1).

The values of the total Mn content at the industrial point were the most noteworthy and fluctuated from 364.2 to 541.9  $\mu\text{g/g}$ , the least recorded during the north east season and the most elevated during winter (Table 1). The maximum levels during winter are because of the low dilution and negligible uptakes of the metal by the plant. The values of the available Mn content differed from 74 and 89  $\mu\text{g/g}$  again the most noteworthy at the industrial point. The industrial point has shown the maximum content of the total Cd and fluctuated from 14.42 to 30.66  $\mu\text{g/g}$  and the available Cd was maximum at the industrial point and fluctuated in the range of 4.5 and 15.66  $\mu\text{g/g}$ .

The results of the Zn total content in the soils at the industrial location differed in the range of 653 and 4011  $\mu\text{g/g}$ , winter season showing the least and the most noteworthy during the north east rains (Table 1). The low levels during winter are because of the significant accumulations by the plants. A similar pattern of higher quantities of the available Zn were observed at the industrial point and differed from 7 to 74.03  $\mu\text{g/g}$ .

**Table -1. Physiochemical characteristics in soils at various sampling sites with seasonal variations**

Sampling Sites & Seasons	p <sup>H</sup>	Conductivity (mS/cm)	Organic matter (%)	Nitrate nitrogen (mg/100gm)	Phosphorus (mg/100gm)	Potassium (mg/100gm)
Site –I	8.402 ± 0.030	0.167 ± 0.006	1.7 ± 0.13	0.102 ± 0.065	0.083 ± 0.005	24.8 ± 0.556
Season 1						
Season 2	8.374 ± 0.098	0.185 ± 0.005	0.65 ± 0.1	0.074 ± 0.005	0.064 ± 0.004	4.0 ± 1.702
Season 3	8.628 ± 0.039	0.213 ± 0.009	1.46 ± 0.09	0.022 ± 0.002	0.134 ± 0.005	16.96 ± 0.722
Season 4	8.53 ± 0.057	0.174 ± 0.004	1.58 ± 0.11	0.123 ± 0.002	0.042 ± 0.002	12.72 ± 0.612
Site II	8.31 ± 0.04	0.184 ± 0.004	1.46 ± 0.13	0.054 ± 0.004	0.202 ± 0.271	38.2 ± 0.556
Season 1						
Season 2	7.826 ± 0.05	0.232 ± 0.036	1.8 ± 0.14	0.104 ± 0.005	0.14 ± 0.052	16.96 ± 0.722
Season 3	8.518 ± 0.093	0.239 ± 0.032	1.18 ± 0.11	0.035 ± 0.005	0.154 ± 0.005	25.22 ± 0.545
Season 4	8.634 ± 0.075	0.165 ± 0.005	1.85 ± 0.10	0.138 ± 0.068	0.056 ± 0.005	50.21 ± 0.551
Site III	5.778 ± 0.196	0.336 ± 0.4	10.67 ± 0.12	0.084 ± 0.002	0.044 ± 0.005	50.21 ± 0.551
Season 1						
Season 2	6.612 ± 4.679	0.234 ± 0.036	2.76 ± 0.14	0.032 ± 0.002	0.035 ± 0.006	16.96 ± 0.722
Season 3	6.432 ± 0.302	0.248 ± 0.044	11.06 ± 0.25	0.045 ± 0.002	0.094 ± 0.002	16.96 ± 0.702
Season 4	6.976 ± 0.397	0.193 ± 0.004	7.94 ± 0.15	0.194 ± 0.002	0.094 ± 0.004	16.96 ± 0.722

Results are means ± SE (n=5)

Andhra University → Site 1  
 (Control Site), Old Jail Road  
 (Commercial Site → Site 2),  
 Hindustan Zinc Ltd (Industrial Site)  
 → Site 3

Winter → Season-I

Summer → Season-II

Southwest Monsoon → Season-III

Northeast Monsoon → Season-IV

Table 2. Heavy metal accumulations ( $\mu\text{g/g}$ ) in soils

Sampling Sites & Seasons	Total metal content in soils			Available metal content in soils		
	Zn	Mn	Cd	Zn	Mn	Cd
Site -I						
Season 1	136.4 $\pm 0.002$	377.8 $\pm 0.022$	25.10 $\pm 0.001$	38.1 $\pm 0.005$	42.79 $\pm 0.011$	11.2 $\pm 0.002$
Season 2	114.9 $\pm 0.001$	171.9 $\pm 0.002$	5.085 $\pm 0.004$	25 $\pm 0.011$	66.0 $\pm 0.02$	0.5 $\pm 0.001$
Season 3	62.33 $\pm 0.031$	305.8 $\pm 0.013$	5.036 $\pm 0.003$	1 $\pm 0.012$	53.0 $\pm 0.011$	0.4 $\pm 0.000$
Season 4	396.9 $\pm 0.002$	216.8 $\pm 0.015$	5.70 $\pm 0.02$	55 $\pm 0.004$	52.0 $\pm 0.018$	0.6 $\pm 0.003$
Sites II						
Season 1	50.97 $\pm 0.019$	187 $\pm 0.05$	4.852 $\pm 0.005$	16.20 $\pm 0.043$	44.68 $\pm 0.04$	11.2 $\pm 0.003$
Season 2	66.52 $\pm 0.02$	167.6 $\pm 0.005$	5.068 $\pm 0.019$	7.0 $\pm 0.016$	67 $\pm 0.082$	0.3 $\pm 0.000$
Season 3	65.99 $\pm 0.005$	224 $\pm 0.026$	4.959 $\pm 0.022$	1.5 $\pm 0.044$	72 $\pm 0.033$	0.05 $\pm 0.003$
Season 4	52.87 $\pm 0.01$	217.5 $\pm 0.001$	5.809 $\pm 0.06$	1 $\pm 0.001$	46 $\pm 0.022$	0.7 $\pm 0.004$
Sites III						
Season 1	653.7 $\pm 0.003$	541.9 $\pm 0.01$	23.5 $\pm 0.032$	74.03 $\pm 0.013$	81.41 $\pm 0.36$	15.66 $\pm 0.001$
Season 2	1966 $\pm 0.011$	394.2 $\pm 0.058$	30.66 $\pm 0.055$	7 $\pm 0.003$	89 $\pm 0.048$	4.5 $\pm 0.01$
Season 3	3400 $\pm 0.02$	444.3 $\pm 0.09$	23.67 $\pm 0.001$	8 $\pm 0.011$	77 $\pm 0.019$	7 $\pm 0.023$
Season 4	4011 $\pm 0.049$	364.2 $\pm 0.001$	14.42 $\pm 0.035$	73.0 $\pm 0.016$	74 $\pm 0.12$	5 $\pm 0.000$

Results are means  $\pm$  SE (n=5)

The total content of Zn in the soils related to the test species showed no huge distinction between the seasons ( $p=0.400$ ) however a noteworthy difference with locations was noticed by two-way ANOVA due to the enormously high quantities at the industrial point. The available content of Zn in the soils related with the test species showed no noticeable difference with the seasons and locales ( $p>0.05$ ) as a significant change was not observed in the values and sometime the same. The total content of Mn in the soils showed no huge contrast between the seasons ( $p=0.095$ ) yet a noteworthy distinction with locations was noticed ( $p=0.002$ ). This is due to a better accumulation at the industrial point and lower accumulations at the commercial point. The available Mn content in the soils showed no huge contrast between the seasons ( $p=0.084$ ) yet a noticeable difference with locations was noticed ( $p=0.005$ ). The total content of Cd in the soils related with the weeds haven't shown any huge seasonal variation ( $p=0.479$ ) yet a huge distinction with locations was noticed ( $p=0.027$ ). This is because of the tremendously high accumulations at the industrial point when contrasted with different locales. The available Cd in the soils related to the weed species has shown a profoundly huge seasonal variation and variation at the locales as well ( $p=0.000, 0.000$ ). This is because of elevated levels during winter when contrasted with different seasons and at the industrial site when contrasted with different locales. This is a direct result of the high accumulations at the industrial site.

### 3.2. Accumulation of Zinc, Manganese and Cadmium in the weed species *Lantana camara* at different sites and seasons

The shoot accumulations of Zn changed from 23 to 643.5  $\mu\text{g/g}$  and that of the root at the control site shifted from 17 to 133.2  $\mu\text{g/g}$  at various locations fluctuating with seasons [Fig.1.a-l]. The most elevated values were seen at the industrial point independent of the seasons. The uptakes shoot of the 643.5  $\mu\text{g/g}$  without showing any injury which is in concurrence with prior studies (Brown, 1995). The accumulations in the plants are found to be much higher than that of the soils which are in great concurrence with prior studies (Joonki Yoon, 2006). The shoot concentrations of the Mn metal at the control point changed from 31 to 120  $\mu\text{g/g}$  and that of root fluctuated from 13 to 61.27  $\mu\text{g/g}$  [Fig.1.a-l]. The species has shown a lower Mn accumulation and better uptake potential for Zn and is tolerant to the metal. The shoot accumulations of Cd fluctuated from non-detectable to

16.44 $\mu\text{g/g}$  and the root accumulations differed from non-detectable to 11.95 $\mu\text{g/g}$  [Fig.1.a-l]. The values of both Mn and Cd have shown maximum amounts at the industrial site regardless of the seasons. Cd doesn't play any vital role in plant metabolism but is recognized to be a cumulative poison. The roots and shoots accumulations of Cd were negligible which could be due to its occurrence in the non-absorbable form. A Cd uptake of 0.1-91 g g<sup>-1</sup> was accounted for in the various plants (Kabata-Pendias, 2011). The root uptakes of the metal is mainly represented by the absorbable form of the metals in the soil (Baker, 1981; Burman et al., 2000).

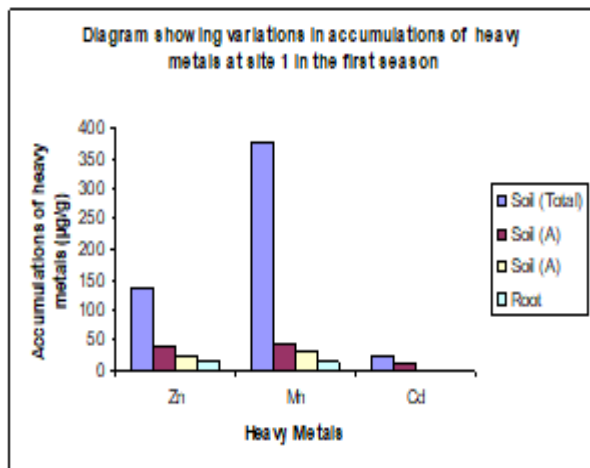


Fig.1.a

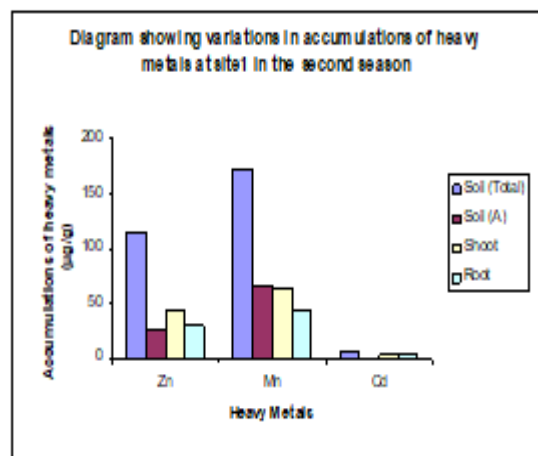


Fig.1.b

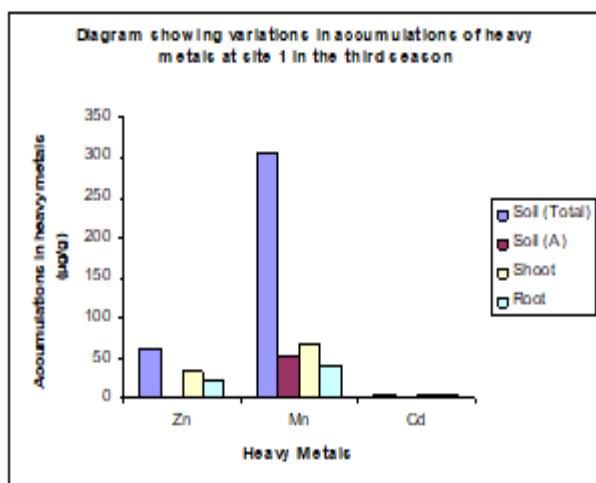


Fig.1.c

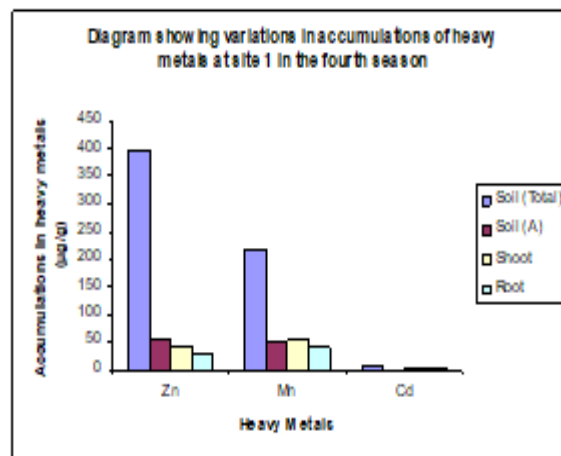


Fig.1.d

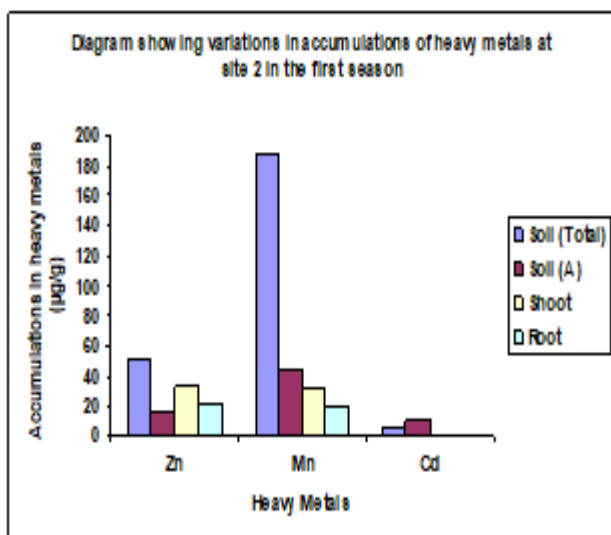


Fig.1.e

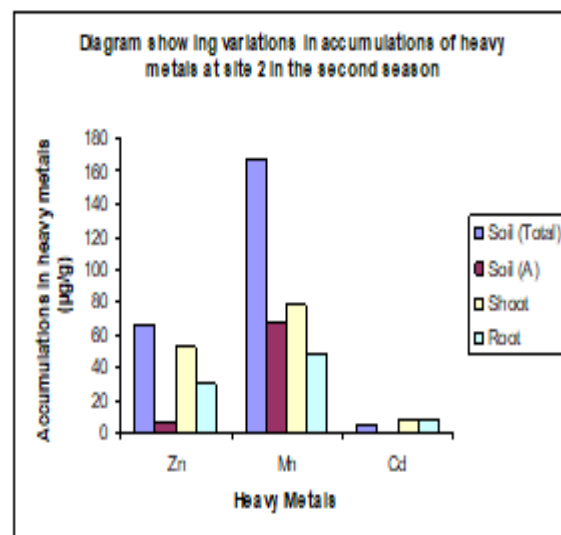


Fig.1.f

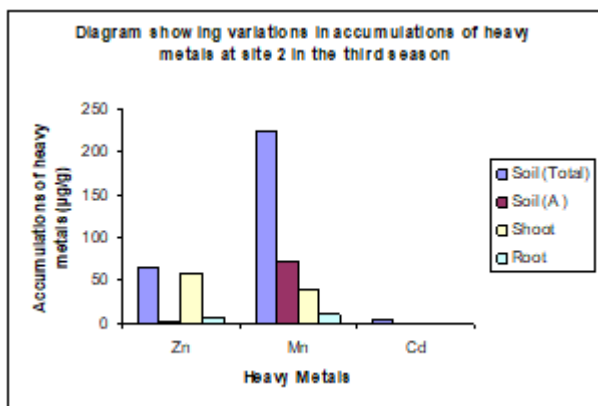


Fig.1.g

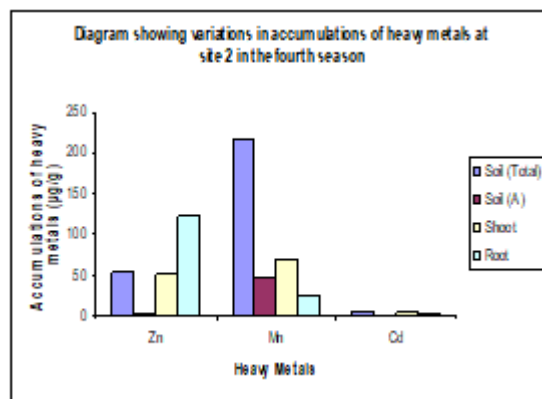


Fig.1.h

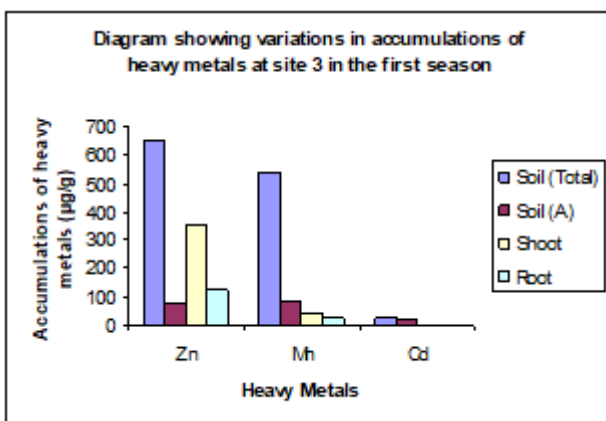


Fig.1.i

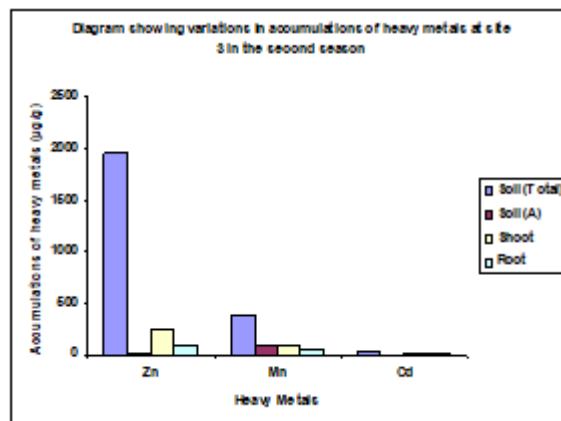


Fig.1.j

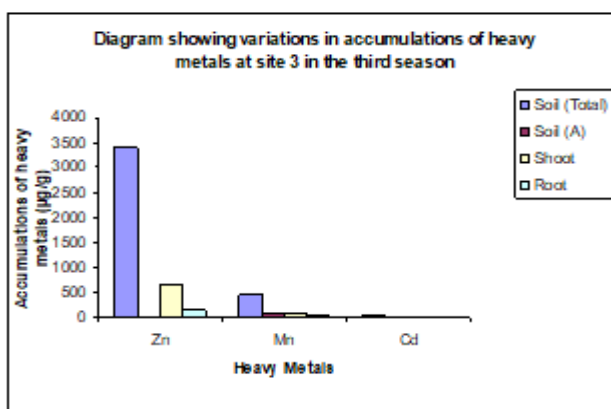


Fig.1.k

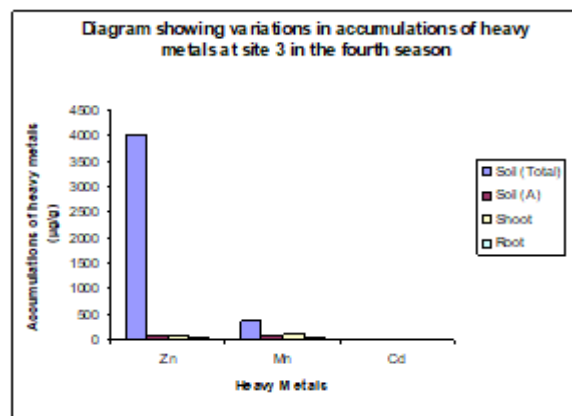


Fig.1.l

Fig.1.a-l. Zn, Mn, and Cd metal accumulations in the weed *Lantana camara* at three sites in three seasons

### 3.3. Bioconcentration Factor (BCF) and Translocation Factor (TF)

The BCF is a significant measure to evaluate the level of metal accumulation in the underground and above ground parts of the weed in relation to their accumulations in the growing substrate. In the current study, the BCF of the weed for all the test metals was found to be >1 (Table 3).

Table 3. The Bioconcentration factors (BCF) of shoots and roots of the heavy metals and the Translocation factors (TF) of the plant.

Sampling Sites & Seasons	BCF of shoots			BCF of roots			TF		
	Zn	Mn	Cd	Zn	Mn	Cd	Zn	Mn	Cd
Site -I Season 1	0.604	0.724	-	0.446	0.304	-	1.352	2.38	-



Season 2	1.762	0.960	5.552	1.183	0.67	4.74	1.489	1.43	1.171
Season 3	34.16	1.276	8.16	22.2	0.886	7.83	1.587	1.44	1.042
Season 4	0.749	1.035	6.182	0.495	0.774	5.282	1.511	1.33	1.17
Sites II	2.037	0.716	-	1.296	0.448	-	1.57	1.6	-
Season 1									
Season 2	7.467	1.165	24.867	4.358	0.729	31.377	1.713	1.598	0.79
Season 3	39.067	0.542	4	1.067	0.142	0.8	9.606	3.823	5
Season 4	51.9	1.514	5.701	30.23	1.059	4.589	1.71	1.42	1.242
Site III	4.794	0.549	0.064	1.644	0.287	0.102	2.916	1.91	0.625
Season 1									
Season 2	36.914	1.005	3.267	14.857	0.688	2.562	2.48	1.46	1.274
Season 3	80.438	0.953	1.559	16.65	0.674	1.707	4.83	1.412	0.913
Season 4	1.316	1.644	3.288	0.813	0.655	2.382	1.61	2.477	1.382

Results are means  $\pm$  SE (n=5)

The BCF of shoots shifted from 0.604 to 80.438 and of roots fluctuated from 0.446 to 22.2 for Zn for various seasons at various locales (Table 3). The TF of the plant for the metal Zn fluctuated from 1.352 to 9.606 most elevated seen during rainy seasons (Table 3). The high BCF and TF values specify that the species is a Zn hyperaccumulator which is in concurrence with the earlier studies (Dixit et al., 2015). The BCF of shoot for Mn fluctuated from 0.542 and 1.644, varied from 0.142 to 1.059 and the TF shifted somewhere in the range of 1.33 and 3.823 (Table 3). The species can be considered a hyperaccumulator of Mn from the values because the BCF and TF ratios were mostly  $>1$  (Dixit et al., 2015). The BCF of shoots for the metal Cd fluctuated from 0.064 to 24.867 and from 0.80 to 31.377 for roots. Whereas, the TF differed from 0.625 to 5 which demonstrates that *L. camara* has the hyperaccumulation potential for Cd and is in concurrence with the earlier studies (Dixit et al., 2015).

#### 4. CONCLUSIONS

The various activities taking place at the HZL have added to the maximum accumulations of Zn, Mn and Cd as well to a certain degree. The high cadmium levels in soils are because of the steel production, incineration processes and zinc manufacture are the cause of very high Cd emissions into the atmosphere. The Mn levels are high because of its utilization in the processes of hardening and strengthening of the steel. This manganese transported by particles of ash which dissolves in water and enters the ground by rain and snow. Due to the corrosion of the rocks Mn also enters into water and soils (<http://www.hoosierenergy.com/tri/manganese.htm>). The Zn and Mn accumulations of the soil and plant are in concurrence with the earlier studies. The high metal concentrations in the plants when compared to the total metal concentrations in soils might be because of the plant's bioconcentration as is observed in the majority of the hyperaccumulators revealed in the earlier studies.

Metal accumulations in the test species' of the roots and shoots was consistently higher than the corresponding soil (Table 3). The BCF ratio the for root and shoots of the metals Zn, Mn & Cd was  $>1$ . The bioconcentration factor (BCF) indicates the plant's ability to efficiently to accumulate and store the metals in tissues. Hyperaccumulators (Brooks et al., 1977) are plants that are extremely tolerant and may accumulate large groups of heavy metals in their above ground tissues at amounts significantly beyond those seen in the soil. They have stronger resistance and accumulation capabilities which improve the phytoremediation viability (Dixit et al., 2015) and they should have a BCF and TF ratios of greater than unity. The translocation factor represent the ability of the plant to translocate the metal contaminant from the roots to the above ground parts of the plant and is taken as the ratio of the metal contaminant accumulated in the above ground parts to the root (Zhuang, 2007; Zacchini, 2009). These characteristics aid in the identification of new hyperaccumulator species. A variety of plant species have exhibited different degrees of metal translocation from roots to shoots. Findings suggest that the weed species *Lantana camara* growing wild in the contaminated environment has adapted to the enormous amounts of the metals and can accumulate the metals Zn, Mn and Cd to a higher level in its body parts. Hence, the plant can be promising in the recovery of the soils contaminated by metals.

The TF ratio of metals in various weeds varied from 0.119 to 3.86 (Cd in *T. procumbens* and Cd in *T. procumbens*) (Pb in *S. oleracea*). Both the accumulator and excluder plant species have a TF  $>1.0$  and  $<1.0$ , according to the authors (Singh, 2010; Wei, 2002). The degree of transfer of the metal from roots to the above ground parts has been observed to vary with the plant species. The findings suggest that the weed species *Lantana Camara*, which thrives well in the contaminated/ polluted environment, has adapted to the very high metal accumulation which can take up and store the metals Zn, Mn, and Cd at a higher level in its body parts. This weed could be used to phytoremediate metal-contaminated soils.

---

---

## REFERENCES

1. American Public Health Association (APHA), 1989. *Standard Methods for the examination of water and waste waters*. 17<sup>th</sup> edn. Washington DC. Part 1000-4500.
2. Gaur, A. and Adholeya, A., 2004. Prospects of arbuscular mycorrhizal fungi in phytoremediation of heavy metal contaminated soils. *Current Science*, 86(4), pp. 528–534.
3. Baker, A.J.M., 1981. Accumulators and excluders strategies in the response of plant to heavy metal, *J. Plant Nutr.*, 3, pp. 643–654. doi: 10.1080/01904168109362867.
4. Barman, S.C., Sahu, R.K., Bhargava, S.K., Chatterjee, C., 2000. Distribution of heavy metals in Wheat, Mustard and weed grown in field irrigated with industrial effluents, *Bull. Environ. Contam. Toxicol.*, 64, pp. 489–496. doi.org/10.1007/s001280000030.
5. Brooks, R.R., Lee, J., Reeves, R.D., Jaffre, T., 1977. Detection of nickeliferous rocks by analysis of herbarium specimens of indicator plants, *J. Geochem. Explor.*, 7, pp. 49–57. doi.org/10.1016/0375-6742(77)90074-7.
6. Brown, S. L., Chaney, R. L., Angle, J. S. and Baker, A. J. M., 1995. Zinc and cadmium uptake by hyperaccumulator *Thlaspi caerulescens* grown in nutrient solution, *American Journal of Soil Science*, 59, pp. 125-133. doi.org/10.2136/sssaj1995.03615995005900010020x.
7. Dixit, R., Wasiullah, Malaviya, D., Pandiyan, K., Singh, U.B., Sahu, A., Shukla, R., Singh, B.P., Rai, J.P., Sharma, P.K., et al. 2015. Bioremediation of heavy metals from soil and aquatic environment: An overview of principles and criteria of fundamental processes. *Sustainability*, 7, pp. 2189–2212. doi.org/10.3390/su7022189.
8. Gupta, N., Khan, D.K., Santra, S.C. 2008. An assessment of heavy metal contamination in vegetable grown in waste water irrigated areas of Titagarh, West Bengal, India, *Bull. Environ. Contamin. Toxicol.*, 80, pp. 115–118. doi: 10.1007/s00128-007-9327-z.
9. Indian Council of Agriculture Research (ICAR), 1997. In Hand Book of Agriculture, Directorate of Publications and Information on Agriculture, Krishi Anusandhan Bhavan, Pusa, New.
10. Joonki Yoon, Xinde Cao, QIXING ZHOU, Lena Q. Ma., 2006. Accumulation of Pb, Cu, and Zn in native plants growing on a contaminated Florida site. *Science of Total Environment*, 166, pp. 456-464. doi: 10.1016/j.scitotenv.2006.01.016.
11. Kabata-Pendias, A., 2011. Trace Elements in Soils and Plants, 4<sup>th</sup> edn. Boca Raton, London, New York: CRC Press.
12. Kumar Narendra, Kuldeep Baudh, Sanjeev Kumar, Neetu Dwivedi, Singh, D.P., Barman Sujib., 2013. Accumulation of metals in weed species grown on the soil contaminated with industrial waste and their phytoremediation potential. *Ecological Engineering*, 61, pp. 491–495. doi: 10.1016/J.ecoleng.2013.10.004.
13. Ovington, J.D., Dale Haitkamp, Donald B. Lawrence, 1963. Plant biomass and productivity of prairie savanna, oakwood and maize field ecosystem in Central Minnesota. *Ecology*, 44, pp. 52-63. doi.org/10.2307/1933180.
14. Sims, J. T. and Heckendorn, S. E., 1991. Methods of Soil Analysis, University of Delaware, College of agricultural Sciences, New York. pp: 1-117.
15. Singh, R., Singh, D.P., Kumar, N., Bhargava, S.K., Barman, S.C., 2010. Accumulation and translocation of heavy metals in soil and plants from fly ash contaminated area, *J. Environ. Biol.* 31, pp. 421–430.
16. Stewart, E.A., Grimshaw, M., Parkinson, J.A. and Quarmby, C., 1974. Chemical analysis of ecological materials, Blackwell Scientific Publications, Osney Mead, Oxford, pp. 1-234.
17. Susarla, S., Medina, V.F., Mc Cutcheon, S.C., (2002), Phytoremediation: an ecological solution to organic chemical contamination, *Ecol. Eng.*, 18, pp. 647–658. doi: 10.1016/S0925-8574(02)00026-5.
18. Wei, C.Y., Chen, T.B., Huang, Z.C., 2002. Cretan Bake (*Pteris cretica* L.): An arsenic accumulating plant, *Acta Ecologica Sinica*, 22, pp. 777–782.

19. Wu, M., Luo, Q., Liu, S., Zhao, Y., Long, Y., Pan, Y., 2018. Screening ornamental plants to identify potential Cd hyperaccumulators for bioremediation, *Ecotoxicol. Environ. Saf.*, 162, pp. 35–41. doi: 10.1016/j.ecoenv.2018.06.049.
20. Xian, X., and Shokohifard, G., 1989. Effect of pH on chemical forms and plant availability of cadmium, zinc and lead in polluted soils. *Water, Air and Soil Pollution*, 45, pp. 265-273. doi:10.1007/BF00283457.
21. Zacchini, M., Pietrini, F., Mugnozza, G.S., Iori, V., Pietrosanti, L., Massacci, A., 2009. Metal tolerance, accumulation and translocation in poplar and willow clones treated with cadmium in hydroponics, *Water Air Soil Pollut.*, 197, pp. 23–24.
22. Zhuang, P., Yang, Q.W., Wang, H.B., Shu, W.S., 2007. Phytoextraction of heavy metals by eight plant species in the field, *Water Air Soil Pollut.*, 184, pp. 235–242. doi:10.1007/s11270-007-9412-2.
23. <http://www.hoosierenergy.com/tri/manganese.htm>.

## A Study on Recent Trends in Life Insurance Business

Bhupesh V. Rane, Raj M. Mhatre and Khoj Agarwal  
Rohidas Patil Institute of Management Studies

### ABSTRACT

Life insurance sector in India is growing at a fast pace. This Sun-Rise industry has given a solid platform for economic growth as well as employment. Post liberalisation many companies are in insurance business, thus the IRDA came with innovative and constructive guidelines for all the products and services.

Customer preference, stiff competition and regulatory control are being a catalyst for innovative products and services. When the policy is procured from advisors, internal marketing and motivation is must to them. Claim management also requires a viable and vigorous system.

Internet and online policy purchase have created a new trend and has become a new focus for all the insurance companies. Low Margins but high volume is the way towards policy sourcing. Rural, social and Micro insurance is a new avenue to be looked at.

This paper discusses the present trends and future prospects of Life insurance business. The study is limited to life insurance sector. The conclusions of this paper will enable both academicians and industry personnel to re-examine their way of thoughts & execution in life insurance business.

Keywords: Life Insurance, Life Insurance Business, Recent Trends.

### INTRODUCTION

Aspects of Life Insurance Industry have been consistent and grown over the years with premiums. In today's low interest rate environment, however customer finds traditional savings for the future policies unattractive. It is very difficult to convince the importance of life insurance to the young individuals & specifically allow time to the insurance agents.

The proportionate size of the young adulthood population is growing. Life expectancy is up. The gig economy is expanding. All these factors are influencing the insurance needs of today's customer. In addition to insurers' traditional "Payer role", they are evolving to take on "partner & risk preventer role" by integrating wealth, health & lifestyle products with life insurance policy.

New agile entrants in life insurance business are leaving their mark with innovative and unique solutions. Policyholders expect more convenient, digital, personalized and engaging experience. They want 24/7 services via the channel of choice. So today there is a paradigm shift to newer business & engagement models. They are managing the emerging industry landscape by looking at the latest technology advancements-AI, data science & blockchain to improve their business efficiency.

The total insurance penetration in India in 2019 was 3.76% (life insurance 2.82% & non-life 0.94%) which is now 4.2% (life insurance is 3.15% & non-life insurance is 1.05%) in FY 2021. In terms of the size of insurance industry in India, the share of life insurance in total premium in India is 74.94% (2019-2020). In life insurance business, India is ranked 11<sup>th</sup> among the 88 countries, for which data is published by Swiss Re. India's share in global life insurance market was 2.73% during 2019-2020.

### Recent Trends in Life Insurance Business



---

## STATEMENT OF THE PROBLEM

The study is done briefly to analyze the recent trends of the life insurance business.

## REVIEW OF LITERATURE

**Sinha and Tapen (2005)**, in their research article “The Indian Insurance Industry: Challenges and Prospects” have stated that India is among the most promising emerging insurance markets in the world.

**Subir Sen (2008)**, in his article “An Analysis of Life Insurance Demand Determinants for Selected Asian Economies and India”, has highlighted that in India the economic variables such as income, savings, prices of insurance product, inflation and interest rates & demographic variables like dependency ratio, life expectancy at birth, crude death rate and urbanization are few significant determinants which effect the insurance consumption.

**Nagaraja Rao, K. (2010)**, in his article “Challenges in Designing Need Based Products in Life Insurance for Inclusive Growth in India”, analyses the challenges faced by the insurers in designing need-based products in insurance for inclusive growth, and concludes that the policies of life insurance companies are still not rural-centric, catering to the specific needs of the people. With a view to popularizing life insurance, he recommends that the consumers need to study the rural market, analyse the specific needs of each segment and design innovative products, to suit the requests of the people to the objective of inclusive growth.

**Sonika Chaudhary, Priti Kiran (2011)**, in their paper “Life Insurance Industry in India - Current Scenario” discussed that life insurance in India’s trend from the year 2005-06 to 2010- 2011.

**Upadhyaya and Badlani (2011)**, in their research, attempt to identify the key success factors in the life insurance industry, in terms of customer satisfaction so as to survive intense competition and to increase the market share.

**Vijay Kumar (2012)**, in his PhD thesis, “A Contemporary Study of Factors Influencing Urban and Rural Consumers for Buying Different Life Insurance Policies in Haryana”, The study outlines that the insurance agent was the most influential factor for selecting the life insurance policy among rural and urban policyholders. The other crucial determinants of buying behaviour were also identified such as income, economic status, product attributes, agent attributes, and price. The result indicates that there was a significant difference in the buying behaviours of rural and urban policyholders.

**Yogesh Jain (2013)**, in his article, “ Economic Reforms and World Economic Crisis: Changing Indian Life Insurance market place” reviews on life insurance scenario in India, the challenges of the sector and the issues .

**Dr Sunayna Khurana (2013)**, in her article, “Analysis of Service Quality Gap in Indian Life Insurance Industry” analysed the gap between customer expectation & customer perception in the life insurance industry.

**Mouna Zerriaa and Hedi Noubbigh (2015)**, in their research paper, “Determinants of Life Insurance Demand in the Middle East and North Africa (MENA) region using a sample of 17 countries over the period 2000- 2012. This research states that consumption increases with income, interest rates and inflation and also it highlights that country’s level of financial development, life expectancy and educational attainment stimulates life insurance demand in a nation.

**Sachin Surana & Amar(2013)**, in the research article lapsation of policy; a threat or curse for life insurance industry. This research has attempted to find out the cause and effects relationship of the Lapsation of policy.

## OBJECTIVES OF THE STUDY

1. To study the present trends in life insurance business.
2. To understand future prospects of life insurance business.

## RESEARCH METHODOLOGY

Exploratory research methodology is used here to analyse the data. Data was collected from multiple sources such as books, journals to understand the Life insurance industry, visited different websites and professional magazines. So, it is purely based on available secondary data.

## DATA ANALYSIS & FINDINGS

Overview & Implications of the top trends that are shaping the insurance industry and how digital technologies are driving irreversible change.

---

---

### **Trend-1: New Models, Personalized Products**

**Overview:** Life Insurers are becoming a partner to policy holders by accessing their data to provide personalised value-added services. They are also playing role of a preventer by coaching their customers to make better health and lifestyle choices.

ICICI Pro Raksha, HDFC life, Max life, India first life, Kotak life, excide life, TATA AIA life insurers are collaborating with third parties so that they can bundle wellness programme policies as value added services to provide customers a holistic health management experience.

By including health & wellness initiatives into a bundled insurance product, insurers create a market opportunity. As wellness initiatives encourage a healthier population, insurers loss ratio should improve due to lower claim pay-outs-it's a win-win situation for both insurers and policyholder.

### **TREND-2: AI & Automation for Faster Claims**

**Overview:** Increasingly, life insurers are turning to analytics & AI to generate insights from vast amount of data to improve underwriting accuracy & speed.

Bermuda based re-insurer Partner-Re & data analytics company VERISK collaborated to develop a life insurance underwriting solution that uses advanced voice analytics & AI technologies to identify applicants requiring further testing.

Canadian insurer MANULIFE beefed up its internal data & analytics with an AI algorithm that speeds up the underwriting process.

MUNICH RE automation solution predictive modelling technique & Machine learning algorithm is used to automate underwriting.

### **TREND-3: Advanced Analytics & Proactiveness**

**Overview:** Life-insurers are leveraging facial analytics to offer customers a fast, efficient & more engaging onboarding experience. In 2019, US based Re-insurer Gen Re introduced "NOW" a mobile App that uses facial analytics to estimate the age, gender & BMI of a prospect. Because of these policies can be issued quickly & without medical examination or

paperwork.

With the connected devices market poised to a strong growth over the next 5 years, Property and Casualty (P&C) insurers will be able to inform the exact value of loss real time of individual consumers. This will help them proactively respond with timely and highly personalized interventions.

There was a partnership between a Europe-based insurance company and Panasonic. A mobile alert was provided to the insurer and its customers for quick and informed mitigation of issues by Panasonic's sensors

Upcoming technology will increasingly enable insurers to obtain high-definition images via drones for remote and accurate estimation & analysis of property. A few leading U.S. auto insurers deployed drones to assess Hurricane Harvey's damages. With the help of the drone technology, 90% of the claims were settled by an Australian company in 90 days. U.K.-based insurance company leverages predictive analytics to model complex customer behaviour, achieve enhanced pricing accuracy and significantly reduce decision time. A U.S. insurer deploys a telematics device to provide drivers real-time feedback to encourage safe-driving. This has helped customers save up to 40 percent on insurance premiums.

Advanced analytics will be deployed to dynamically segment users and needs, model behaviours and identify exceptions, adjust policy prices, optimize business strategies, and identify new growth opportunities. Scale can be further incorporated through automation, AI and machine learning to transform insurers into active risk managers.

### **TREND-4: Insurtech Partnerships**

Supported by Robo advisors, insurers are creating intuitive procedures that offer consumers interactive, personalised advice along the buying journey & decision-making process.

Clark- a German insurer Tech offers robo advisory services via mobile App that can analyse gaps & help insurers improve coverage.

North America company for life & health insurance simplifies the application process by leveraging publicly available data and short telephone interview to eliminate the lengthy application procedure and medical exam requirement.

Insurers are becoming more customer centric by utilising advanced and widely accepted digital channels to beef up engagement. Future Generali under life insurance delivers policy documents instantly & directly via whatsapp to enhance convenience & accessibility.

Overall, it will be a win-win situation — the traditional insurance company will be at advantage take tech support for faster result also the same will lead to larger customer base, funding and domain expertise. It will enable fresh model of revenue streams for higher profitability and reduced operational costs. Lastly consumer benefit would be the ultimate goal looking into consumer experience. A digital enhanced life-insurance premium will allow policyholder with greater convenience and an improved experience which leads to customer satisfactory.

#### **Trend-5: Mainstreaming Blockchain**

The application of block chain in life insurance may range from selling, distribution, underwriting & fraud detection, to claim initiation & settlement. Some life insurance companies are leveraging blockchain to streamline the death claims process & make it more customer centric to mitigate instances of unclaimed benefits.

METLIFE incubator lumera lab in collaboration with Singapore press holdings in building a smart contracts platform “LIFE CHAIN” to help families quickly determine whether the deceased had a policy & to file a claim automatically.

The Institutes risk stream collaborative, & LIMRA have developed a block chain App-“Mortality Monitor” to leverage social security data, Policy holder records, and other data sources to help insurers quickly notify eligible beneficiaries about pending life insurance death benefits.

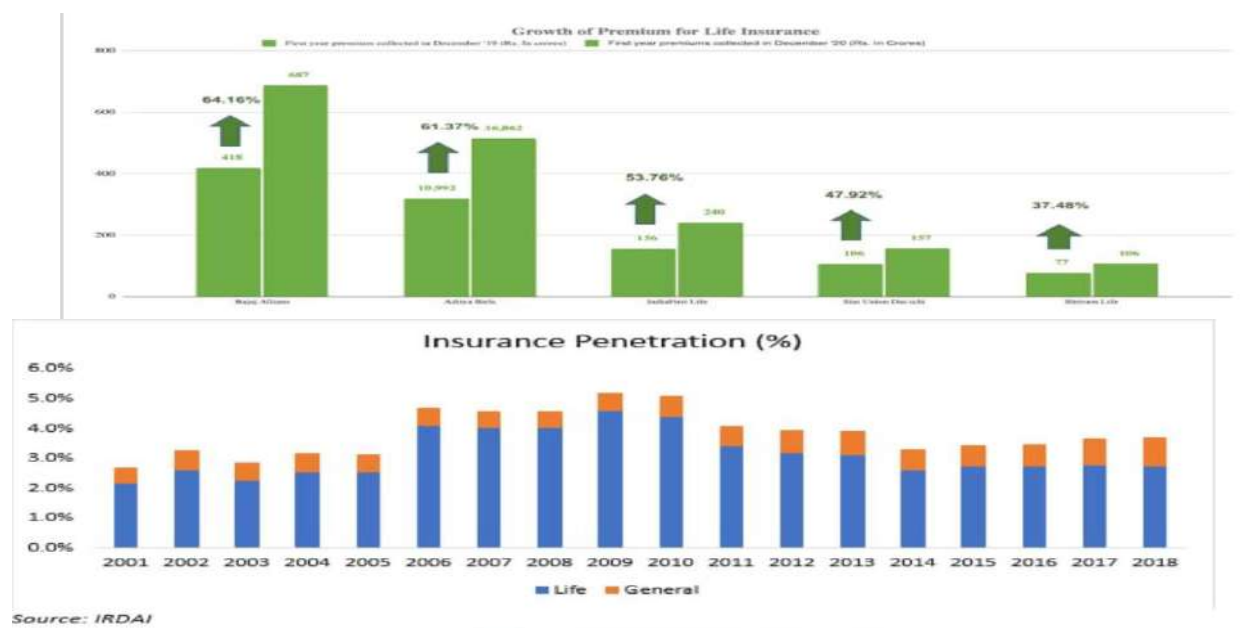
The above information clearly indicates that insurance business is a multibillion business. There is no rocket science attached to it but to understand how and when to assess potential leveraging existing and new technologies.

#### **Indian Industry Scenario**

- India's premium share in global life insurance and non-life insurance market was at 2.73% and 0.79% respectively, during 2019.
- The total insurance penetration in India was at 3.76% in 2019 (life insurance 2.82% and non-life 0.94%) and the total insurance density in India was at \$78 in 2019-20 (life insurance density: \$58, non-life insurance: \$19).
- In terms of the size of insurance industry in India, the share of life insurance in total premium in India is 74.94% and the share of non-life premium is 25.06% (2019-20)
- Life insurers recorded new business premium of INR 2.78 tn (\$38 bn) in FY21 growing at 7.49% over the last year with private life insurers growing at 16.29%. Private Life Insurers account for 33.8% of the industry's new business premium (FY21) with the rest being accounted for by the Life Insurance Corporation of India (LIC).
- The Life Insurance Industry in India recorded a total premium of INR 5.73 tn (\$81.3 bn) in FY20 witnessing a growth of 12.75% over the previous year and the private insurers accounted for 33.7% of total premium underwritten by the industry. New business premium contributed 45.25% of the total premium and witnessed a strong growth of 20.59% over FY19. 60% of the new business premium was derived from single premium with remaining 40% accounted for by first year premiums
- During the last year (FY20), life insurers issued 288.47 lakh new individual policies, out of which LIC issued 75.9% of policies and the private life insurers issued 24.1% of policies.
- Health insurance witnessed 13.3% growth in GDPI in FY21, while fire insurance and liability insurance observed 28.1% and 16.4% growth respectively in the same period
- AB PM-JAY is an entitlement-based scheme under Ayushman Bharat and is fully funded by the Government. It is the largest health assurance scheme in the world and aims at providing a health cover

of INR 500,000 (\$6,900) per family per year for secondary and tertiary care hospitalization to over 107 million vulnerable families (approximately 500 million beneficiaries).

- The insurance regulator IRDAI has played a pivotal role in amplifying the Insurance sector, such as permitting insurers to have KYC on video calls, in order to discriminate other motives, have standardised plans and allowing insurers to offer rewards for low-risk behaviour.
- Strong growth in the automotive industry over the next decade is expected to boost the motor insurance market. Meanwhile, the steep yield curve will give advantage to the life insurance sector, with low short-term rates and higher long-term rates.
- Continuous growth can be expected from digital insurance & online sectors, the share of web aggregators within digital insurance has been consistently increasing and web-aggregators currently originate 30-40% of digital insurance.
- The total mortality protection gap in India stands at \$16.5 tn (as of 2019) with an estimated protection gap of 83% of total protection need. This offers a huge opportunity to life insurers with an estimated additional life premium opportunity of average \$78.2 bn annually over 2020-30
- India is the 2nd largest InsurTech market in the APAC region, accounting for 35% of the \$3.66 bn capital invested in this region. The online individual insurance market opportunity is estimated to be \$1.25 bn by FY25 more than tripling from \$365 mn in FY20.
- The increase in the FDI in Insurance from 49% to 74% announced in the Union Budget (Feb'21) shall further help in driving increased penetration and coverage by enabling additional avenues for capital support required for the expansion of the insurance industry in India.
- The recent pandemic has emphasized the importance of healthcare on the economy, and health insurance would play a critical role in the effort to strengthen the healthcare ecosystem.



## SUGGESTION

Life insurance in India is in a growing stage and to maintain it, the following points should be considered:

- To develop flexible product solutions suitable for a challenging regulatory and interest-rate environment.
- To personalise every aspect of the customer experience.
- To initiate more of InsurTech start-ups operating in India to reinvent skills & capabilities.
- To boost growing awareness of the need for protection and retirement planning wrt demographic factors such as growing middle class, young insurable population

## CONCLUSION

- The life insurance industry is one of the **most profitable** industries in the world.



- This industry has to be **ready for more challenges** due to ongoing changes in the economy and modes of employment.
- More number of players around the world have planned to enter into India looking to the potential available here.
- They must be prepared to build a customer centric approach, support product agility, adopt intelligent processes & foster an open ecosystem.

#### REFERENCES

1. <https://www.businessinsider.in/the-insurtech-report-how-financial-technology-firms-are-helping-and-disrupting-the-nearly-5-trillion-insuranceindustry/articleshow/60258913.cms>
2. <https://www.itnews.com.au/news/qbe-deploys-drones-to-assess-insurance-claims-452739>
3. <https://www.nationwide.com/smartride.jsp>
4. Balaji, C. (2015). "Customer awareness and satisfaction of life insurance policy holders with reference to Mayiladuthurai town." *International Journal of Multidisciplinary Research and Development*.
5. Dr. Sonal Nena et al. (December 2013 ). "'Performance Evaluation of Life Insurance Corporation (LIC) of India'." *International Journal of Advance Research in Computer Science and Management Studies* Volume 1(Issue 7): pg.113-118.
6. Dragos, S. L. (2014). "Life and non-life insurance demand: the different effects of influence factors in emerging countries from Europe and Asia." *Economic Research*.
7. Harpreet Singh Bedi, D. P. S. (November 2011). "An Empirical Analysis Of Life Insurance Industry In India." *International Journal of Multidisciplinary Research* Vol.1( Issue 7).
8. Jain, D. Y. (Jan. - Feb. 2013). "Changing Indian Life Insurance market place". *IOSR Journal of Business and Management (IOSR-JBM)* Volume 8, (Issue 1 (Jan. - Feb. 2013)): PP 106-115.
9. Jindal, S. (2014). "Ethical Issue in Insurance Companies: A Challenge for Indian Insurance Sector." *International Journal of Computer Science & Management Studies* Vol. 14(Issue 09).
10. Kumaraswamy, S. (2012). "Swot Analysis For Bancassurance: Application Of Confirmatory Factor Analysis: Review Of Research " Vol.1,(Issue.11). 14. Kumbhar, V. M. (2013). "A Study of FDI in Life Insurance Sector in India." [www.researchgate.net/publication/235923557](http://www.researchgate.net/publication/235923557).
11. Luqman Adedamola Sulaiman, S. M. T. Y. (2015). " "Investigating the factors influencing the life insurance market in Ethiopia". " *Problems and Perspectives in Management* Volume 13( Issue 2).

---

---

## **Dr. Babasaheb Ambedkar's Contribution to the Emergence of the Reserve Bank of India**

**Bhupesh Rane, Shalu Chanana and Kaustubh Kamble**  
Rohidas Patil Institute of Management Studies

### **ABSTRACT**

Below we are discussing the Contribution of the Greatest Indian Ever Vishwa Ratna Dr Babasaheb Ambedkar in the emergence of the reserve bank of India. His Initial Economic Thesis the problem of rupee, its origin & Solution, in which elaborating the SoE Statement of Evidence on the basis of which he argued with The Royal Commission on Indian Currency and Finance (Hilton Young Commission).

### **Dr. Ambedkar – An Economist Extraordinaire**

Dr Ambedkar's basic training was in Economics. He got his MA-PhD from Columbia University, the USA in 1915 & 1917 respectively. The Doctor of Science (DSC) which the

London School of Economics conferred on him in 1923 was also for his research in Economics.

### **His 3 Books on Economics:**

1. Administration & Finance of the East India Company
2. The Evolution of Provincial Finance in British India &
3. The Problem of the Rupee: Its Origin and Its Solution.

The first two represent his contributions to the field of public finance, the third book represents his major contribution to the field of Monetary Economics in which he crossed swords with influential economist John Maynard Keynes!!!

### **How Reserve Bank of India Was Established?**

The Royal Commission on Indian Currency and Finance (Hilton Young Commission) came to India and submitted its report in 1926. Dr Ambedkar submitted a Statement of Evidence (SOE) to the Commission in response to their Questionnaire. Dr Ambedkar's unchallenged authority in Monetary Economics is reflected in this SOE.

Finally, RBI was established nine years later in 1935 based on the SoE submitted by Dr Ambedkar

### **What Did Dr Ambedkar Argue In His Soe?**

"The Gold Exchange Standard cannot be continued with any advantage to India and for the following reasons: It has not the native stability of the Gold Standard. It is economical. But for that very reason, it is insecure. You cannot therefore both economize gold and also use it as a standard. If you want to economize gold, then you must abandon gold as a standard of value, in other words, the economy of the Exchange Standard is incompatible with its security. The choice therefore can never be between a Gold Standard and an Exchange Standard. I think the Gold Standard must be accepted as the only system of currency that is "knave proof" and "foolproof."

Turning to the most important question of "the ratio between gold and rupee", Babasaheb observed:

"There is but this difference between India and the other countries. The other countries have yet to reach pre-war parity. India, on the other hand, has overreached the pre-war parity. As a result of the difference, the problems before India and the other countries are different. In European countries the problem is one of deflating the currency, i.e., appreciating it; in other words of bringing about a fall in prices. In India, the problem becomes one of inflating the currency, i.e., depreciating it; in other words, bringing about a rise in prices. For a change from 15 6d. gold to 1s. 4d. gold means this and nothing else... Some people are under the impression that the restoration of pre-war parity would give justice and would also give us the old price level to which we were so long accustomed...

Both these views are fallacious. First: the restoration of pre-war parity is not a restoration of the pre-war price level. For it is to be remembered that 1s. 4d. gold in 1925 is not the same thing as 15s. 4d. gold in 1914 if measured in terms of purchasing power. The same ratio of exchange does not necessarily mean the same level of purchasing power. The ratio between the two currencies may remain the same through their respective volumes have undergone enormous changes. provided the variations in volumes are equal and in the same sense. This is

exactly the result of a mere nominal restoration of the pre-war parity. If restoring pre-war parity is meant the restoration of the pre-war level of prices then the ratio instead of being lowered from 15. 6d. in the direction of 1s. 4d. must be raised in the direction of zs. gold.

In other words, instead of inflation, there must be a further deflation of the currency. Second: the restoration of pre-war parity even nominally would be unjust. As a standard of deferred payment, a currency should not disturb monetary contracts. Given these two facts the best solution would be to strike an average between 1s. 4d. and 15. 6d., and to see that it is nearer 15.6d. and away from 1s. 4d... if it is realized that low exchange means high internal prices, it will at once become clear that this gain is not again to the nation coming from outside, but is again from one class at the cost of another class in the country.

Now the class that suffers is the poor labouring class, which pays the bounty to the richer or the business class. Such a transference of wealth from the poor to the rich can never be in the general interest of the country. I am therefore strongly opposed to high prices and low exchange, and no righteous Government should be a party to such clandestine picking of the pockets of the poorer classes in the country"

**His Contributions as an Economic Philosopher:**

Though Dr Ambedkar didn't write any book on economics after 1923, he was active in implementing his economic philosophy into action. As a nominated member of the Bombay Provincial Legislative Council (1926) and later as an elected member of the Bombay Legislative Assembly (1937-1939), he offered a critical appraisal of the provincial budgets presented then.

He dealt with the problems of Indian Agriculture, Poverty and fought against oppressive institutions like Kothi System and Mahar Vatan. He founded Independent Labour Party (ILP) with a significant economic philosophy.

As a Labour Minister at Viceroy's Executive Council, he emerged as an Economic Administrator par excellence with contributions to labour, employment, skill development and welfare of labour. He worked remarkably in the field of power, water management, mineral resource management and public works

Even the fact that the Constitution of India is said to have embodied more economic and financial provisions than any other constitution in the world can be attributed to the influence of Dr Ambedkar as an economist in the Constituent Assembly.

As a Democrat, he spelt out his views on the ideal strategy for India's economic development in his Memorandum States and Minorities (1947).

**Sources:**

- 1) Dr Ambedkar, An Economist Extraordinaire by Dr Narendra Jadhav.
- 2) SoE to Hilton's Commission, Volume 6 of BAWS.

---

---

## **Concealed Compensations: A Missing Facet of HR in the Indian Banking Sector**

**Bhupesh V Rane, Abhinandan Kumar and Abhishek Budhkar**  
Rohidas Patil Institute of Management Studies

### **ABSTRACT**

In today fast paced world with growing technological & Intellectual growth education, Agriculture, FMGC, Automobiles, NBFC, Hospitality & many more. Private banking sector is not far from attracting lucrative compensation & benefits in India. Salary, monetary & Non-Monetary benefits places crucial role on employee performance while working in private banking sector. The study aims to private banking factor that impact the employees in selecting private banking jobs keeping in mind salary, CTC, compensation & perquisites. The Data is collected using structure questionnaire & using basic statical tools & data analysis tools for conclusion. The study is an attempt to find our various compensation packages offered and problems related to same in Indian private banking sector.

Keywords – Salary, CTC, Payroll & Problems.

### **INTRODUCTION**

Indian Banking Industry had experienced tremendous growth in last 2 decades with technological & conveying improvement with system & customers. Banking Industry are in very stiff competition among the other banks. Banks had introduced Automatic teller machine (ATM), Internet Banking which had helped many Unorganized & Organized Employer as well as employees to transfer their salaries directly to their following bank accounts. Banks also came up with plastic money (Debit cards & Credit cards) these helped workers & employees to get their salary in cash for handling their personal finance, managing finance is also done with Mobile banking for personal use so that they do not need to visit banks on regular basis

According to employee's performance, Compensation and benefits or pay represents exchange between the organization & employee. The study on compensation management gives the brief information about the employee compensation in the organization as it explains employee rewards system and it determine the performance of employee on their work.

The present definition of compensation, shows both intrinsic & extrinsic components of CTC, Basic, DA, other allowance, hike, bonus, award & public recognition. While intrinsic & extrinsic compensation covers both monetary & non-monetary rewards, reflects the employee's mental satisfaction with their job accomplishments.

### **LITERATURE REVIEW**

Ms. Nidhi (2015), The Author studied research paper on "A Comparative study of compensation & Benefits packages satisfaction of Indian public versus private banks employees". Whenever a candidate joins a company or an organization for job, there has been employment contract between employer & employee. This contract act as a relationship among both of them, in this contract the employer pays a remuneration to employee for rendering services to employer. Hiring the right talent for right position as understanding the requirement for employment work & providing attractive package for new talent. On the basis of study both private bank employees have different reasons for work structure & culture, for offering their employment service to bank.

Mr. Vamshidhar Reddy (2017), The Author studied research paper on "A Study on Compensation Management with Reference to Bank employees working in Hyderabad". The Study helps to aim & find out the impact of compensation on employee proficiency & job satisfaction towards compensation. The study was done at Hyderabad and the sources was primary & secondary source, the response was asked to fill the questionnaire and the data was collected from various other sources like books, survey reports & websites etc. In this study some employees only notice Rewards & Increment of salary, but some employees get motivate and enthusiastic towards their work and job. So that they can maintain their work ethics towards the organization.

Dr. Vijaya Lakshmi Pothuraju (2016), The Author studied research paper on "Compensation & Benefits for Employees in Banking Sector" (With reference to SBI & Axis Bank at Guntur, A.P.). In this study the aim was to examine the outcome of compensation & benefit on employee performance in Banking Industry, Compensation plays a crucial part for employees. The point of study is to investigate the standardization of compensation & benefits among employees of banking sector. Compensation & benefits has become leading feature of modern life.

Prof. Nawab Khan & Ms. Suhalia Parveen (2012), The Author studied research paper on “Salary and Promotion– Predictors of Job Satisfaction A Comparative Study of Public and Private Sector Banks in India”. Beyond the research studies, job satisfaction is really considered a need. There is some issue addressed on the bases of multifarious aspect of job satisfaction, which all includes salary, develop organization and techniques, turnover etc. This study is explanatory and the data has collected from self-questionnaires. As known a self-satisfied employee is strength of an organization,

### OBJECTIVE

- To study the factors that affects the performance of employee related to salary & benefits
- To identify the compensation structure of 2 private banks in Mumbai region
- To analysis problems related to compensation & benefits provided by private banks in India.

### RESEARCH METHODOLOGY

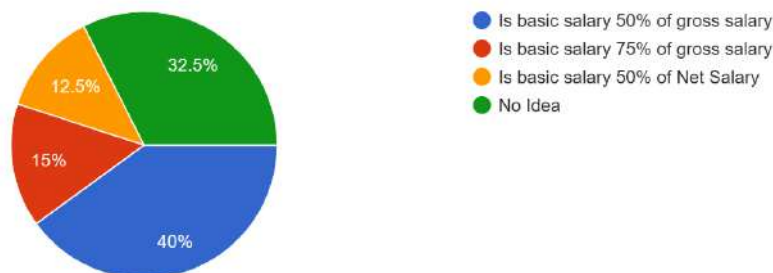
The Study was based on survey method. The data for the study has been collected through two sources – the Primary Data & Secondary Data.

**Primary Data** – We have asked many people from our class as well as from our working friends regarding salary breakout & compensation, maximum was not aware of basic components of salary structure. We had circulated some questionnaire of google form related to the topic, hence to collect data from their perspective we had found around 87% wasn't aware of the salary break up & minimum percentage of components.

**Secondary Data** – As we had referred several research papers and websites articles, we had analyzed that in every research maximum numbers were not aware of the process.

What do you know about salary structure & Components percentage?

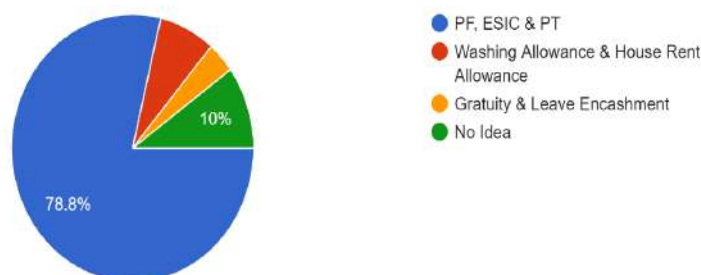
80 responses



### FINDINGS

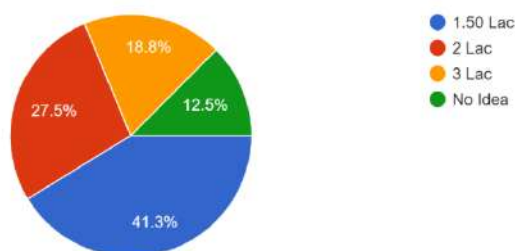
What are the Deductions known under Salary?

80 responses



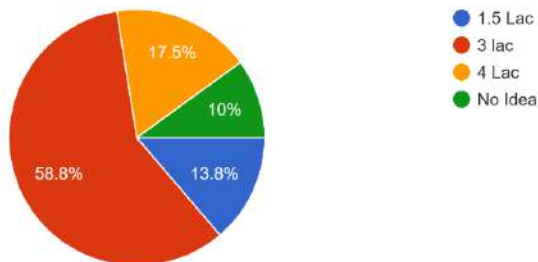
Expectation of Salary for freshers on their basis of Qualification (Under Graduate) PA?

80 responses



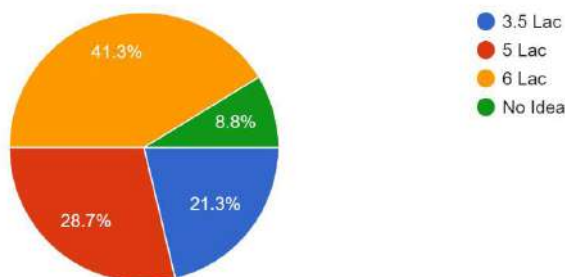
Expectation of Salary for freshers on their basis of Qualification (Graduate) PA?

80 responses



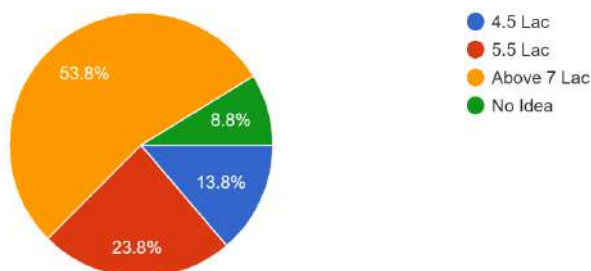
Expectation of Salary for freshers on their basis of Qualification (MMS / MBA/ PGDM) PA?

80 responses



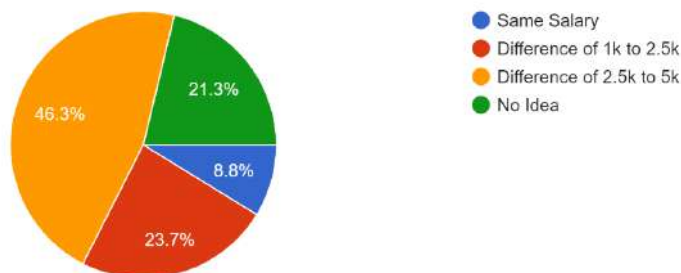
Expectation of Salary for freshers on their basis of Qualification (CA/ CS/ LLB) PA?

80 responses



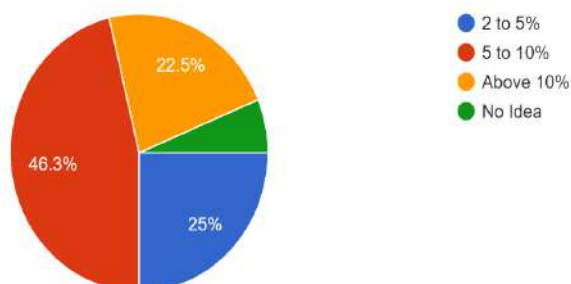
what is the Salary difference of uneducated person & graduate Person?

80 responses



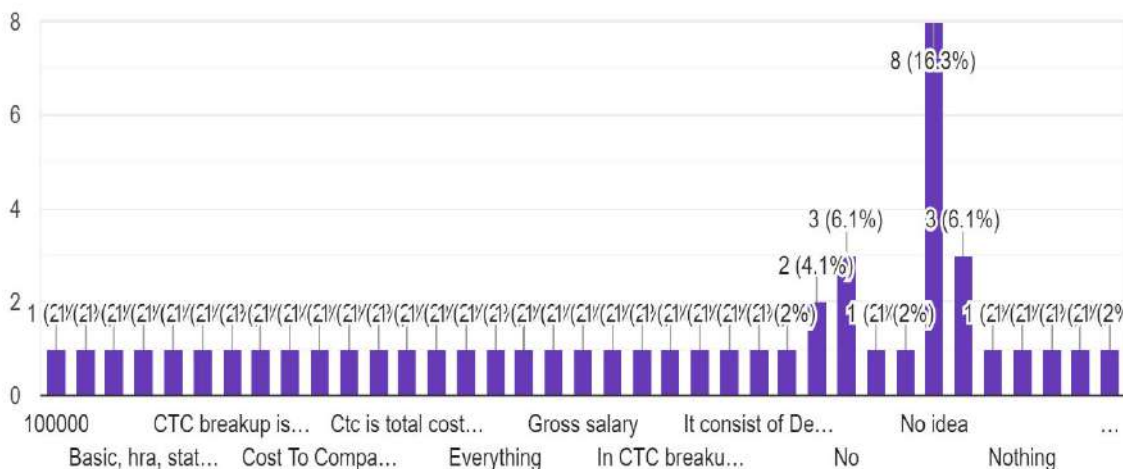
What are the Salary increment percentage

80 responses



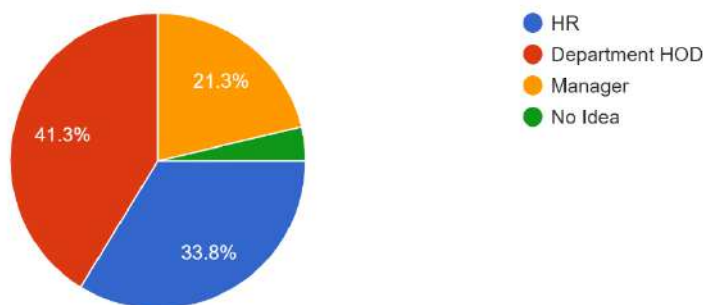
What you know of CTC breakup?

49 responses



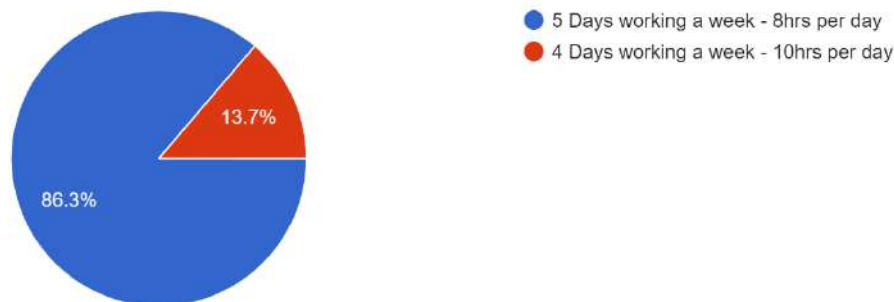
Who should be responsible for increment in salary & Compensation?

80 responses



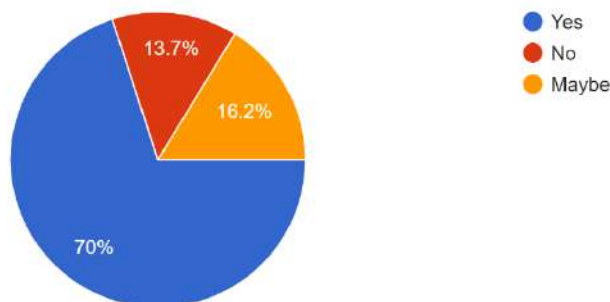
What should be the working schedules?

80 responses



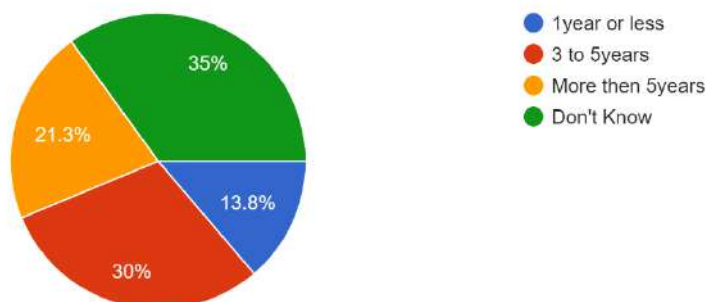
Do you keep invoice, vouchers & receipt of all payments?

80 responses



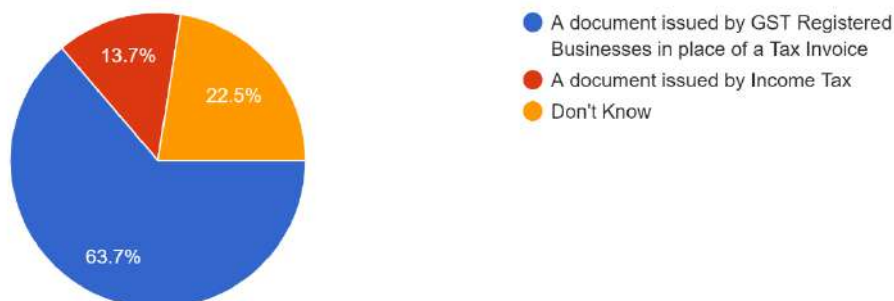
Does your organization keep accounting records including invoices, vouchers, receipts and timesheets for how many years?

80 responses



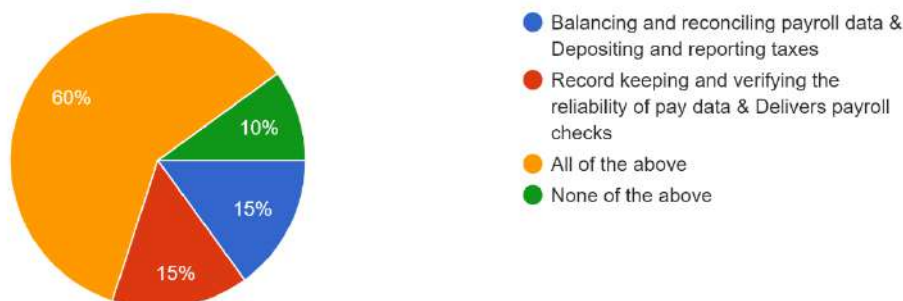
What is bill of supply?

80 responses



what functions are involved in Payroll?

80 responses



## DATA ANALYSIS

In this survey we can understand most of them aren't aware of CTC, Salary break up & there are few responses which states they have some basic knowledge of salary structure. We can also refer the charts some aren't handling invoices, vouchers & receipts for future reference, as working in corporate every invoice, bills, vouchers & receipts should be maintained and kept for reference whether soft copy or hard copy. We can see most of the responses have no idea on CTC break up, the HR should be responsible to make a candidate understand his CTC break, statutory bonus, compensation benefits along with the percentage, as this are the basic rights of the candidate or employee.

## CONCLUSION

Under this research we study about the Indian private banking standardization of compensation & benefits among employees of banking sector. The working factors which determines the job satisfaction & performance effects their work culture & work schedule. Work overload, benefits, pressure & confliction are the factors responsible for job Performance. Some employees only notice rewards from their salary, when the HR or employer communicate with them regarding their increment & the day received their paycheck including their increase salary, but there are still some people's organization that have strong work ethics & continue to stay motivated regardless of their compensation package provided.



---

In our detailed analysis, we had done to understand and results showed up the less accuracy in Human Resource Laws, Compensations & salary breakouts. The high compensation level of private sector banks has different criteria to judge the performance level as compared to public sector banks.

**REFERENCE**

1. Balakrishna, M. (2015). Compensation Management Practices and its Impact on Work life of Private Bank Employees with reference to Hyderabad City-A Study. eISSN:2455-4464, 55 - 61.
2. Kanchana, D. K. (2019). Comparative Study on Quality of Work Life of Bank . (ISSN-2349-5162, 695 - 709.
3. Nidhi. (2015). A comparative study of Compensation & Benefits packages satisfaction of Indian public versus private banks employees. IJAR , 117 -228.
4. Parveen, P. N. (2013). Salary and Promotion - Predictors of Job Satisfaction: A Comparative Study of Public and Private Sector Banks in India. JEL Code: J3, J5, M5, 1 - 20.
5. Pothuraju, D. V. (2016). COMPENSATION AND BENEFITS FOR EMPOLYEES IN BANKINGSECTOR. International Research Journal of Human Resources & Social Science, 83 - 95.
6. YADAV, S. G. (2018). A COMPREHENSIVE REVIEW OF FACTORS. Indian Journal of Economics & Business, 401-410.
7. (Balakrishna, 2015)(Nidhi, 2015) (Pothuraju, 2016) (Parveen, 2013) (Kanchana, 2019) (YADAV, 2018)

## A Review of Supply Chain Challenges in Indian Steel Industry

Suneet Mathur and Prasanta Kumar Mohanty  
Centurion University of Technology and Management, Odisha

### ABSTRACT

Steel Industry of India contributes nearly 2% to India's GDP of USD 10 trillion during the year 2015-16, and stands to be very important for the development of the country. However, with opening up of economy, international competitive sales threats and technological challenges are being faced constantly by this industry. This comes at a time when Indian Steel producers happens to be the lowest in terms of cost, in the world. New ways of absorbing cost over-runs while keeping cost of production under control remains a constant challenge for Indian Steel Manufacturer's. Research is about exploring the possibility of cost reduction through adopting supply chain techniques like inventory management and vendor optimization.

Keywords: Supply Chain Management, Steel Industry, Inventory Management, Cost Reduction, Vendor Optimization.

### 1. INTRODUCTION

Indian Iron and Steel industry has had its presence for a long time and has graduated to a status of being the second largest steel producer in the world (111.2 million metric ton). China being the world's largest steel producer (996.3 MT). India has made significant strides in updating its steel technology through global partnerships, merger and alliances. India is blessed with a significant reserves of Iron ore and other minerals, which could provide enough of raw material in years ahead. With the onset of globalization, the industry is facing a unique challenge of mitigating low-priced, high-quality steel from imported steel manufacturers. New avenues of cost cutting are being looked at by steel manufacturers and Steel Ministry to nullify the effects of imported steel availability to Indian markets. As with every other competition, survival of the industry will solely depend on how the operations team would innovate to bring in new methodologies to mitigate cost overruns.

#### 1.1 History of Indian Iron and Steel

The history of India's Iron and Steel industry dates back to 3rd and 4th century BC when Sushruta a great authority on medical science in ancient India described in his book a 100 surgical instruments made out of caste iron. Ancient wars weapons were made of corrosion resistant iron using a patented knowhow which the Hindus knew praised then by Arab Edrisi. The rise and fall is a part of any civilization and India was no different to it. Its iron and steel upsurge really began when "against tremendous odds and with great tenacity of purpose, Jamshedji Tata realised his grandiose dream of erecting India's First Steel Plant at Jamshedpur in 1911" The era between 1911 and 1947 witnessed World Wars and the great economic depression globally, while the ruling East India Company left India as an independent nation in 1947. The successful establishment of this concern was "a happy historical accident" because the odds were formidable. At the time of Independence (1947) Indian steelmaking capacity was standing at a mere 1 million ton. Though now it challenges to be the world's second largest steel producing nation in the world. The country had a controlled policy regime then, and therefore restricted itself to a very slow rate of progress as the years advanced. Some the policy restrictions inflicted to the industry then were:

- Import restrictions on capital items, finances and exports
- Rail freight equalization policy for equalized overall growth parity
- Quantitative restrictions and high tariff barrier
- Production capacity control and licensing procedures Dual pricing procedures for large and small steel producing sectors

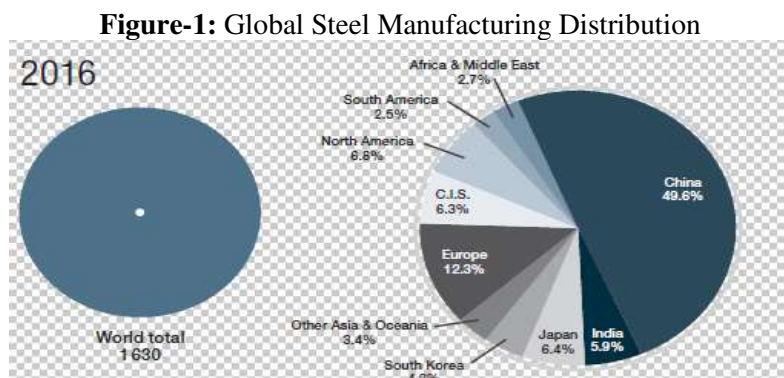
However, these Governmental restrictions were reversed, during the market glut of the 80's and 90's. Most of the restriction were now aimed at spurring the steel sector growth. Post 1992 saw a new era of Indian steel industry growth, where private steel manufacturers like m/s ESSAR, JINDALS, ISPAT and TATA group went up to plant their flagship of steel manufacturer's presence. Even public sectors like SAIL(Steel Authority of India Limited) and RISNL(Rashtriya Ispat Nigam Limited) went ahead in importing technology to create more value added products for the market demands, with increase in their exports. However, 1996-1997 started revealing a decline in the domestic economy with glut in the sales both in internal and external markets.

Post 2002, the steel market did a turnaround, where in huge demands for steel was happening with overall change in the market scenario. This again took a turn around 2010 where the market went into a slump leaving behind a more matured manufacturers who used their ingenuity to create base for themselves in terms of setting up their own markets, products and R &D to cater to their customers.

**1.2 OBJECTIVES OF RESEARCH:**

The objective of the study includes:

1. To study the inventory strategies of VMI of three top steel manufacturers'
2. To examine the Vendor Managed Inventory as right fit for steel industry in cost savings.



Source: World steel Association 1967-2017

The Indian Steel producers have been struggling to remain profitable and growth oriented. The market could open up the increased sales and profitability provided major constraints are put in order including new Government and private investment in infrastructure. The steel anti-dumping laws coupled with MIP (Minimum Import pricing) would have to be reviewed from time to time by the ministry of steel, while new tariff barriers may have to be incorporated in order to prevent international steel producers to sell their products below the local market rate.

While all of these controls are known and adopted, steel companies have also been looking internally into their operations to curtail the undesired cost. The supply chain function of an organization provides a fair ground in terms of optimization of the value chains across the line of production with respect to planning, internal and external sourcing, asset utilization, marketing, customer deliveries and services, logistics, quality control, research and development, process re-engineering, cost recoveries through salvaging and recycling.

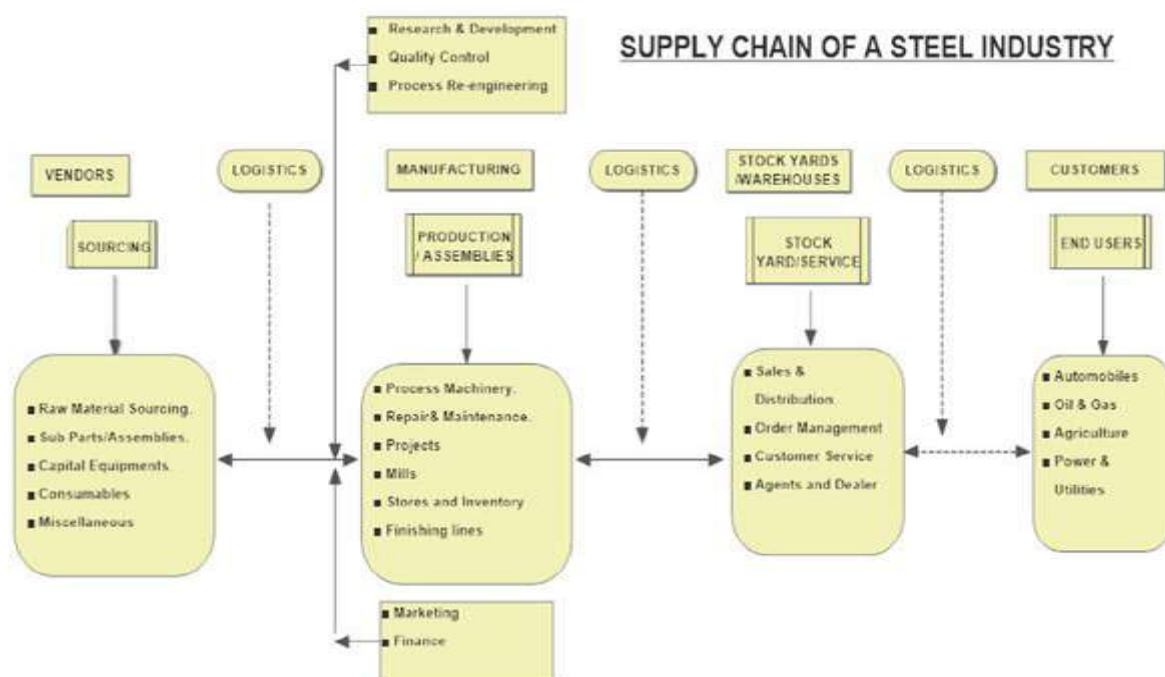


Fig. 2: Supply Chain Basic Model

### **1.3. Supply Chain Applications in Indian Steel Industry A Review:**

The Indian Steel Industry supply chains are as complex as any steel industry in the world. It is laden with high demands of raw material, power, and water, which have to be continuously replenished, while the customer demand pattern fluctuates coupled with input material prices fluctuating based on the demand and supply scenarios. The raw material, oil and energy cost, logistics plays on a huge impact while the steel producers have a tough time balancing their production and cost. For thought clarity supply chain deals with procurement, vendor development, manufacturing, quality and marketing. Logistics on the other hand focuses on in-bound and out-bound material movement, material storage and their management.

Shapiro (2004) defined SCM(Supply Chain Management) as a new business paradigm was motivated by interest in integrating procurement, manufacturing, and distribution activities-Integration made possible by advances in IT(Information Technology)

Mohanty and Deshmukh (2005) defined SCM as a loop which starts with customer and ends with customer. Through the loop flows all the materials, finished goods, information and transactions. It requires looking at business as one continuous seamless process. This process absorbs distinct functions such forecasting, purchasing, manufacturing, distribution, sales and marketing into a continuous business transaction.

### **1.4 Supply Chain Challenges**

The supply chain challenges are very critical in nature. While Governmental support is crucial in a developing economy, there is a limitation to that support, while internal operational changes would be paramount in retaining both growth and profitability.

Some of the identified remedial to shape the future of steel industries have been listed below

- Reshaping governmental regulatory frame work
- Raw material security
- Infrastructure and logistic
- Sustainability and environmental reforms
- Asset management and reliability
- Trade agreements
- Research and development for innovation in new technologies
- Supply chain optimization
- Hydrology /Utility sector
- Energy sector
- Talent retention
- Hedging

All of these remedials could be contributing towards Steel industry growth and GNP/GDP. Quality Control Order(s) is a step by the ministry of steel towards control of seconds and defects in India. This is vital to the fact that Indian steel industry has been through a lot of glut and margin dilution owing to heavy dumping of cheap steel in the country (2014-2015). Both China and the Russian Steel started to dump steel at the price which gave the Indian Steel manufacturer's a hard time. Even though the Indian Government imposed anti-dumping duties and minimum import prices, the same came a big respite to the ailing steel industry.

A similar situation is also being faced by the US where in, it imposed tariff barriers on China and Canada. Owing to such dumping policies, almost all Indian Steel companies invested heavily in updating their technologies and ventured into brown and green field expansion to be cost competitive and quality steel manufacturers striving for the status of a world class manufacturer.

### **1.5 State of Market in Indian Economy for Iron and Steel in India:**

The current state of World economy has begun to show signs of recovery while the Indian economy has a challenging target of 7.4 % in 2018 against a previous year figures of 6.8 %. The domestic demand for steel would continue to rise, while it would be a flatter projectile for China and countries of Russian belts. The

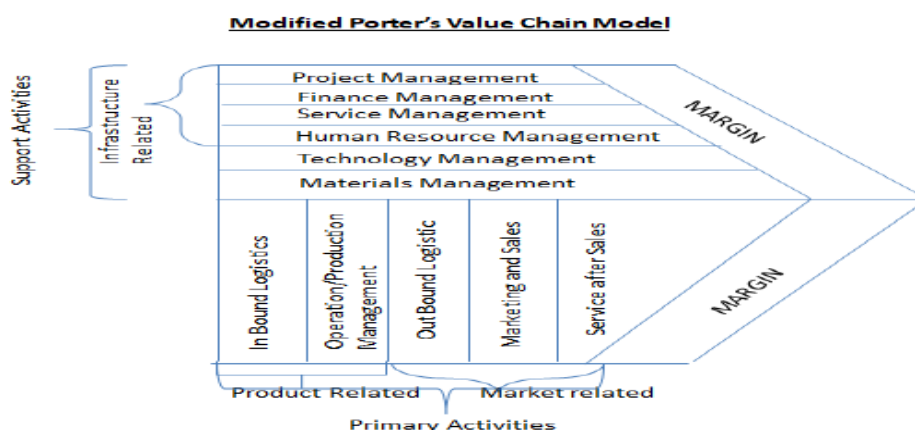
global economy is poised at a growth of 3.8%. (Source: International Monetary Fund) The major internal consumers of steel for India would be:

- Road and housing construction
- Capital machineries and tools
- Consumer goods
- Automobile manufacturing

Earlier, Michael E Porter(1985) had developed a value chain model for the manufacturing sector identifying five activities and four support functions. A “Value Chain” as defined as a chain of value-added activities: products pass through the activities and in a chain, gaining value at each stage. The value chain in real terms affect the cost of an activity along with existing support functions. A steel industry fits the concept, with additional special activities as have been identified by Acharyalu et al (2015) in their paper: Value Chain Model for Steel Manufacturing Sector: A Case Study.

As per Acharyalu et al the value chain devised by Porter has five primary activities and four supporting activities, while this model cannot be used in steel industry directly owing to the dynamic nature of a steel industry. Acharyulu et al modified the model by inducting five primary activities and six supporting activities, while naming it Value Chain for Steel Manufacturing Sector(VACSMS)

**Fig 3: Porter’s Value Chain Model**



### 1.6 Vendor Management:

The profitability of a steel company is based on both primary and supporting activities, as can be seen in the Porter model, as a way to drive margins in a Steel organization. While study of the Porter’s entire model activities is beyond the scope of this study, we will be targeting the supporting vendors, a part of material management as model to show areas of cost improvement. One of the components of supply chain is the supplier or the vendors offering their merchandise, which acts as a basic raw material to the manufacturing of product or services.

Vendor’s supplies to both manufacturing and services in keeping the cost of operations in check is a paramount thing of operations control, and gross margin improvement

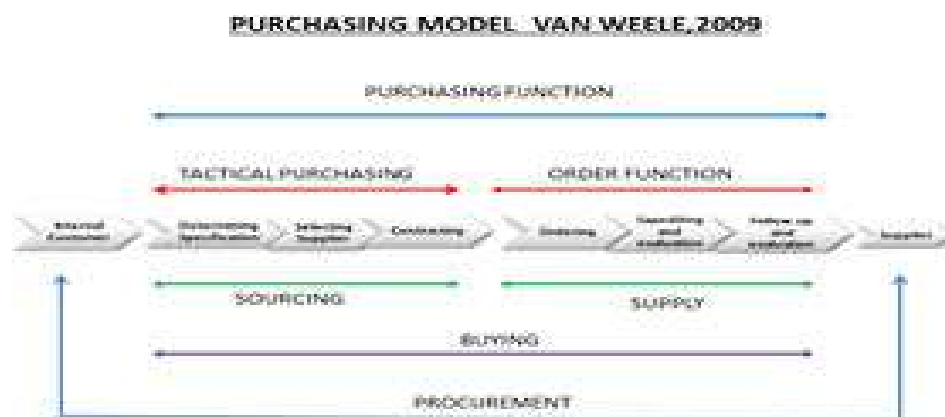
In order to get clarity on vendors, it is important to understand three basic concept of sourcing, procurement and purchasing.

Vendor selection begins by first sourcing the availability of the material itself. Sourcing basically implies the utilization of means to access resource requirements. According to Lew G: Sourcing = Procurement + Purchasing, while according to Solomon K, Procurement=Sourcing + Purchasing (LinkedIn 2014)

Procurement refers to the management of business partnerships between vendors and sourcing. While purchasing is the acquisition of an approved good, and is part of material management. As per Van Weele (2009) in his book Purchasing and Supply Chain Management agreed that:

“In practice, as well as in literature, many terms and concept nowadays are used in the area of purchasing. However, no agreement exists about the definition of these terms. Terms like procurement, purchasing, sourcing and supply management are used interchangeably”

Fig 4: Purchasing Model



**1.7 Vendor Selection Criteria's:**

As the economy progressed most researchers seriously went after researching the requirements for vendor selection and their performance analysis. This was crucial and vital for the demanding industry which was seeking higher quality and workmanship with a greater emphasis on its cost of production.

Various authors have suggested ways of vendor selection within the complexity of procurement. Various Purchasing authors have expressed views on purchasing strategies. While, the list goes on, some of the well known authors like Webster and Wind(1972), Dobler et al (1996), De Boer(1998), Cousins(2008), Van Weele(2009) and Monczka et al (2011), have had different sets of ideologies in terms of freezing a common agenda of vendor selection.

The major criteria extended by these authors have been quite diverse, while in current state of affairs called for risk elimination, continuous improvement, cost reduction, quality, timely deliveries. Dickinson (1966) proposed 23 criteria's regarding vendor selection. However, as the technologies progressed and business environment changed. As a contradiction to the findings of Dickinson and Weber, their work was proven irrelevant in newer context by Cheragi et al(2004).

A cost based and policy-based approach method was proposed by Ford et al (1993) which included reliability in delivery, technical capability, cost effective, and financial stability of a supplier. Banker and Khosla extended a strategic standard element. Similarly, Talluri and Narsimhan (2004) identified some further elements like cost reduction performance (CRP)

Researchers like Vasina (2004) identified eight main categories and sub-categories beginning from discounting, Quality, Service levels, global presence, flexibility and commitment, Terms of delivery and payments, modes of delivery and transportation including adoption of INCOTERMS, vendors financial strengths, in house Research & Development, Information Technology deployment, Information sharing, Environmental commitment, Corporate Social Responsibility (CSR), Sustainability.

In this mammoth and complicated jargon of selection criteria's, the selection methodology gets complicated, thus requiring and mix of both quantitative and qualitative evaluation. The selection criteria could be analysed by quantitative techniques as per Vasina (2004)

**Table -1:** Different Techniques Used

Type and Use	Pre-Qualification	Final Selection
Statistical/Probabilistic	Cluster Analysis	Fuzzy Set Theories and other models
MADM	Categorical Model	AHP ANP TOPSIS Outranking (ELECTRE & PROMETHE)
Mathematical programming	DEA	
Methods based on cost		ABC TCO

In final selection of vendors, AHP (Analytical Hierarchical Process) an algorithm developed by Thomas L.Saaty in 70's has been a popular one since time in accessing vendor attribute ranking. A typical ranking is shown in figure below.

**Table -2:** Supplier Selection Criteria

CRITERIA	DESCRIPTION
PRICE	<ul style="list-style-type: none"><li>• Unit Price</li><li>• Pricing terms</li><li>• Exchange rates</li><li>• Taxes</li><li>• Discounts</li></ul>
QUALITY	<ul style="list-style-type: none"><li>• Quality features: material, design, dimension, durability</li><li>• Variety: range of product selection</li><li>• Production Quality: production line, manufacturing techniques, machinery</li><li>• Quality Systems</li><li>• Continuous improvement</li></ul>
SERVICE	<ul style="list-style-type: none"><li>• Customization: size, shape, colour, design, packaging</li><li>• Minimum Order Quantity</li><li>• Communication: Respond time, information, respond time</li><li>• Industry knowledge</li><li>• Agility, Warranties</li></ul>
DELIVERY	<ul style="list-style-type: none"><li>• Lead-time</li><li>• On time performance</li><li>• Fill Rate</li><li>• Reverse processing</li><li>• INCOTERM compliance</li></ul>
RELIABILITY	<ul style="list-style-type: none"><li>• Reference: Buyers feedback</li><li>• Financial stability</li><li>• Reputation</li><li>• Strategic partners</li><li>• Organizational personnel</li><li>• Diversity of ownership</li><li>• Cultural awareness</li></ul>
TECHNOLOGY	<ul style="list-style-type: none"><li>• R &amp; D facility</li><li>• IT software</li><li>• e-commerce</li><li>• Security</li></ul>
BUSINESS ETHICS, ENVIRONMENT & SUSTAINABILITY	<ul style="list-style-type: none"><li>• Green Supply Chain</li><li>• Environmental Quality Standards</li><li>• Safety compliance</li><li>• CSR</li></ul>

In meeting the supply chain challenges, vendor selection offers a better way to manage resource and mitigate risk of sourcing. However, one of the issues of cost control remains a challenge to most of steel mill operations which could be also looked out by way of looking at inventory control, most steel mills operate in today. To take the research further, I look at the roles of vendor taking up the role of managing inventory at customer end via Vendor Managed Inventory (VMI)

### 1.8 Global Competitiveness:

As per WORLD STEEL DYNAMIC report (2018) the cost or production for Indian Hot Rolled coils was \$349 per ton, being the lowest in the world compared to \$428 in China, \$429 in South Korea with a global average of \$418 per ton. Ironically, the Chinese made steel, out sold Indian Steel in Indian market by selling at \$80 below their margins leading to the worries of Indian Steel manufacturer who have been struggling to keep up with additional cost of logistics, which is three times higher than China (as per Director General – Institute for Steel Development and Growth) with additional Capital cost of 10-12 % against 1-2% in China. This has led to an

import jump of 58% for imported Steel in spite of Indian Government imposing an import safe guard duty of 20 % on imported Steel.

Considering the above cost issues and the real time deployment of capacity utilization, Indian steel industry could work on lean inventory management as way of reducing total cost of operations (TCO reduction) A vendor managed inventory (VMI) involves a seller taking over the part of supplying and managing the inventory of its manufactured product at customer site. It's a high-profile topic in a supply chain, while this model works around improving service levels and optimizing inventory.

VMI model relationship began in the 90's stimulated by highly visible arrangements between Wal-Mart and some of its suppliers like Proctor and Gamble (P&G) and Rubbermaid. Later the success of Wall Mart /P& G led to other success stories worldwide :Fasson MPD , a division of Avery-Dennison and Worselys, Baxter International and large number of hospital customer in North America and YCH Singapore. With availability of technologies like EDI (Electronic Data Interchange), Bar Coding, and economical computational power, it was easier to launch on VMI. This concept of VMI though was more prevalent with retail sector, it also drew attention of industrial marketing.

### **1.9 VMI Challenges and Benefits to a Steel Industry**

Simple as it may seem, VMI needs a relook into both strategic and operational side of any business function. Getting the right vendors and opening up the internal company information to vendors within a dynamic business environment becomes a strategic challenge, while targeting performance metrics, human resource deployment, and process designing became the operational challenge to incorporating a VMI in industry.

While the goal of any business is to expand business with increased sales, internally they would be enthused to make supply chain their competitive tool for expense control in order to "pick the spot, and do it right" A VMI can be useful in meeting these goals by using customers for information, while inducing suppliers to make a choice of production and effective delivery.

Reading some of the case studies of Vendor Managed Inventories, I am encouraged to take my research forward to major Indian Steel Companies like Tata Steel, JSW Bellary and SAIL collective to find the strategies for VMI adoption and the future procurement modifications to such strategies. The current undergoing study would include reasons for approaching VMI, the feasible areas and the improvement in TCO (total cost of operations) for customer and profit/revenue improvement for the vendor. Areas of improvement as far as supplier or user (customer) is concerned would include the following:

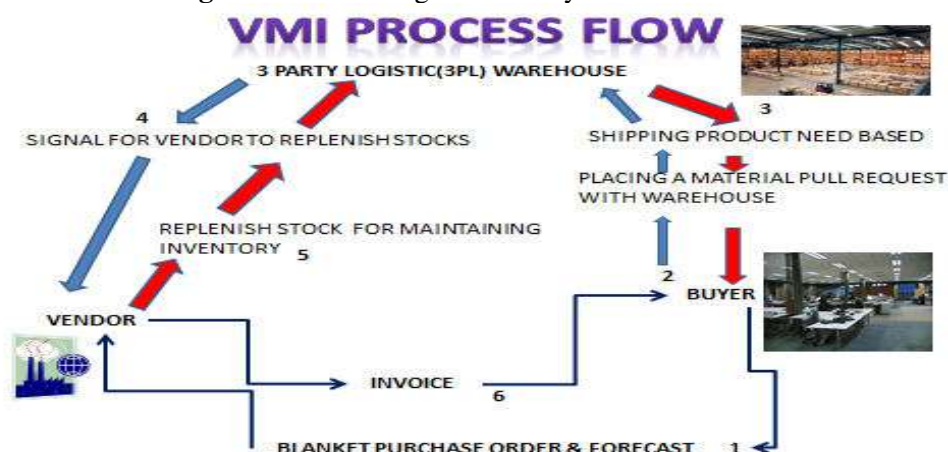
- Improved inventory management as the role of inventory management is taken over by the supplier with reduced lead times.
- Fewer stock outs which tend to increase production/sales
- Controlled replenishments which tend to induce faster inventory turns
- Reduced administrative and transactional cost.
- Cash flow reductions.
- Savings on Acquisition cost
- Stronger Supplier relationship leading to improved collaboration and reliable supplies.

Areas of improvement as far as the supplier (Vendor) is concerned may include parameters like:

- Demand Sensing being more accurate and therefore easier to set production budget targets
- Day Sales outstanding (DSO) reduction
- Cost control
- Business consolidation
- Assured revenue with chances of billing more delivering efficiencies.
- Improved relationship with customer and chances of future growth



Fig 5: Vendor Managed Inventory Process Flow



### 1.10 Vmi Modelling Framework:

The conceptual frame work would include emphatical studies including TOPSIS to model an algorithm to determine the best fit for steel industry to incorporate VMI in items and their inventories based on the a wide variety of low and high volumes, perish ability and durability, criticality and non-criticality, and varied demand patterns. This in turn would add up the TCO (total cost of operations)

### CONCLUSION

While VMI or the SOI (Supplier Owned Inventory) system is getting popular in the industries both service and retail/industrialist has been adopted in a very measured way. Undoubtedly, the customer tends to gain financial benefits off by removing the entire inventory of holding cost or carrying cost, the burden of the inventory shifts to the supplier. Given an environment of competition, strategic customer relationships, bulk long-term business relationships would the vendor take a decision to offer its terms towards extending a VMI program to its customer. The next step of research would be to examine what strategies have the steel companies taken to adopt a concrete VMI program for themselves. How could that in turn relate to a change in operational savings

### REFERENCES

1. Acharyulu S G, Subbaiah K Venkata and Rao K Narayana, (2015), Value Chain Model for Steel Manufacturing Sector: A Case Study, International Journal of Managing Value and Supply Chains (IJMVSC) Vol. 6, No. 4, December, pp. 45-53
2. Annual Report 2016-2017, Ministry of Steel, Government of India. Pp 11-29
3. HurkensKrisje, Valk van der Wendy, Wynstra Finn, (2006), Total Cost Of Ownership In Service Sector: A Case Study, The Journal of Supply Chain, Winter Feb 2006: 42,1: ABI/INFORM Global, pp 27-37
4. KrishanchaiSineenart, MacCarthyBart L., Cost Performance Of Traditional And Vendor Managed Inventory Approaches In Hospital Pharmaceutical Supply Chains. Operations Management and Information Systems Division. Nottingham University Business School, United Kingdom
5. Pavithra.J, Kavitha S Fabiola, Gowtham.D, A Study Of Inventory Management System At Tata Steel Processing And Distribution Ltd., International Journal Of Pure And Applied Mathematics, Volume 116 No 18 (2017) PP 155- 161
6. Piplani. R., CordinationIn Supply Chain: Vendor Managed Inventory Is The Way To Go. Centre for Supply Chain Management, Nanyang Technological University, Singapore (2006), Serbian Journal of Management 1(1)2006 pp 41-47
7. Varma.Siddhart, Wadhwa.Subhash, Deshmukh.S.G, Implementing Supply Chain Management in a firm: issues and remedies. Vol-18 No.3,2006 pp.223-224.Asia Pacific Journal of Marketing and Logistics.
8. Vasina Ekaterina,(2014), Analyzing the Process of Supplier Selection. The Application of AHP Method Thesis Centria University of Applied Sciences Degree Programme in Industrial Management.May, pp 83
9. World Steel Dynamic Annual Report, 2018

## To Identify Emerging Trends and Competitive Strategies Adopted by the Hospitality and Tourism Industry during Covid-19 Pandemic

Dhanraj Kalgi, Pralhad Botre and Arvind Sonkamble

Dr. D. Y. Patil Institute of Hotel Management & Catering Technology, Pune

### ABSTRACT

The Industry of Hospitality and Tourism, unquestionably has been a powerful pillar as a trustworthy and consistent source of income and resources for many countries. Majority of the nations have been raised from poor to considerable financial standings as a consequence of the irreplaceable influences their sectors of tourism have flourished in addition to their complete growth of economy. Tourism is a chief contributor to the economy of India. The industry of tourism in India has a stake of 0.52% of global tourism as well as the earnings as 0.89% of the global earnings. There have been substantial developments in the sector of Indian tourism of aggregating capacity of air seats, trains as well as connectivity of railway to imperative destinations of tourism, with linking roads. Facilities of accommodation have been improved for the accessibility of the travelers. By means of the industry in viewpoint, there is relatively an immense array of key players such as businesses, modern technology as well as trends of hotel marketing etc., which are set to take source as well as impact the industry as a whole in 2022 as well as the years to arrive. This research primarily, aims as well as look for to recognize as well as inspect the paradigm shifts in the industry of tourism over the apparent years as well as how the trends have performed in India. It pursues to scrutinize the present trends in the sector of hospitality and tourism, carry to light the obstacles encountered by the sector of hospitality and tourism as well as finally analytically understand the forthcoming predictions of the Indian sectors of hospitality and tourism. The study carried out from the secondary data to discover the conclusions and discoveries. It was nevertheless discovered that worldwide of activities hospitality and tourism are aggregating by leaps as well as bounds therefore a comparable rise in spending equally not only for tourists but also service. *The hospitality and tourism industry is very competitive, as well as businesses required to possess up with the most recent trends of hospitality and tourism to escape being missing behind. Furthermore, keeping leap with the industry of hospitality and tourism as a complete is a good approach to confirm your business supplies the kind of quality experience traveler want as well as expect. Nevertheless, the requirements as well as main concern of traveler have likewise transformed because of Covid-19 pandemic. In this research, done the exploration about emerging trends and competitive strategies adopted by hospitality and tourism industry in Covid-19 pandemic.*

Keywords: Hospitality, Tourism, Covid-19 pandemic, trends, strategies

### INTRODUCTION

The global economy was impacted badly because of COVID -19 pandemic. In the year of 2020, it has been foreseen that the worldwide GDP will be constricted by 5.2 %. One of the economic areas like the hospitality and tourism sector of developing countries like India was the affected the most. Due to policies to reduce the rate of infection, majority businesses of hospitality have been for the time being closed. Social distances, home orders, travel bans as well as travel restrictions have been enforced as a preventive measures during lockdowns. Furthermore, demand for hospitality and tourism businesses that are permitted to carry on has dropped substantially. In a nutshell, the hospitality and tourism sector has come into conditions of uncertainty and chaotic in the fear of COVID19. Like in other developing countries, the sector of hospitality and tourism is a crucial instrument for sustainable financial development in India. In 2019, it delivered 6.8 % of entire GDP as well as 8 % of the entire employment. The most profitable sum of capital is earned from the revenue from domestic trips in India. Nevertheless, with the expansion of COVID-19 at the commencement of 2020, there is a substantial collapse in the hospitality and tourism sector. On March 25, 2020, the lockdown started which carried out till May 31, 2020, because of postponement of the lockdown. The lockdown was lifted on June 8, 2020 and hotels, restaurants as well as tourist destinations were permitted to reinstate. Despite the fact, it is not imaginable to assess the range of the commercial influence of the COVID-19 eruption in the hospitality and tourism sector due to the course as well as period of the eruption are still ambivalent. As the health and lives of the individuals are quiet at stake, it is implausible that the optimistic indications in this hospitality and tourism sector will be reestablished instantly. With regard to, there is a requisite for comprehensive study as well as exploration of the consequence of COVID-19 in the Indian hospitality and tourism sector. So in this research we have tried to find out, emerging trends and competitive strategies adopted by the hospitality and tourism industry in Covid-19 pandemic. It goes with undoubtedly that the pandemic as well as resulting trade and industry downturn larger than the recession occurred in the year of 2008 as well as anarchy triggered by

changeability in requirement have had a substantial influence on hospitality and tourism sector during the years of 2020 and 2021 certainly with persistent consequences. So, some inventive responses to this unexpected circumstances like make an effort to attract clientele back into outlets of food and beverage as well as reassure vacationers that it is certainly harmless to relish a stay in the hotels, have augmented prevailing industry of hospitality and tourism inclinations as well as initiated enduring transformation. For the moment, there has been a transference in the general public, comparatively because of changes in the needs afterward the severe period of the pandemic. Even though in the year of 2020 and 2021, the reputation of staycations, hygiene procedures as well as contactless automations, all nowadays resolutely entrenched in the regular activities of hospitality and tourism industries has increased suddenly, so because this some innovative trends and competitive strategies are emerging. An augmented awareness of hotel guests of all effects purposeful, sustainable as well as health with happiness has fixed innovative yardsticks for enterprises of hospitality and tourism. This research offers the emerging trends and competitive strategies adopted by the hospitality and tourism industry in Covid-19 pandemic in the year of 2022.

### REVIEW OF LITERATURE:

**Baum et al., (2020)** 96% of the travel destination around the world enforced partial as well as full lockdown limiting travel to avoid and hold the spread of the virus, by governments of because of the beginning of COVID-19 initial in the year of 2020. These limitations such as social distancing, lockdowns as well as quarantine measures endure to severely damage the sector of hospitality and tourism.

**Goodwin, (2020)** Service suppliers such as hotels, Airlines as well as event's organizers have grieved massive damages because of the decline in response of the business as majority vacationers withdraw their bookings as well as events get revoked. Pandemic of COVID-19 has significantly obstructed the DNA of the industry of hospitality and tourism at its central.

**Haywood, (2020)** The ambiguity in arrears to the pandemic has enforced the industry of hospitality and tourism to revive as well as gear up to endure sustainably in the forthcoming era. The business previously the pandemic was more unwilling to accept latest technology as well as partner with inventive startups, post pandemic nevertheless the inclinations propose a more cooperative methodology to stand in the upcoming era

**Baum and Hai, (2020)** The industry of hospitality and tourism is the first to be suffer as well as the last to recuperate when damaged by disasters or crises. Even though seriously damaged by COVID-19, the sector of tourism and hospitality will progressively overcome itself, nonetheless, the rapidity of retrieval as well as to what range it will continue its previous magnificence is unidentified.

**Dehler, (2020)** The Pandemic of COVID-19 has individuals be anxious for fortification and security of not only their external physical healthiness but also for the internal safeguard of their immunity; accordingly, the industry of hospitality and tourism observance this characteristic in cognizance are gearing up for the forthcoming since even though the pandemic will diminish the clientele of the industry of hospitality and tourism will imagine advanced criterions of hygiene as well as wellbeing.

**PricewaterhouseCoopers, (2021)** Customer perceptions, customers have progressed for the enhanced throughout the pandemic; they are nowadays additional than forever into digitalization, technology as well as enhancing more globally responsive. The report likewise piercing out that customers are fetching more sensible about expenses, healthiness and statistics.

### OBJECTIVES

- To identify the impact on hospitality and tourism industry during Covid-19 pandemic
- To recognize Emerging trends and competitive strategies adopted by the hospitality and tourism industry during Covid-19 pandemic

### RESEARCH METHODOLOGY

Secondary data was gathered through several sources such as references materials, newspapers, magazines, internet, books etc.

### RESULTS AND DISCUSSIONS

**Emerging trends and competitive strategies adopted by the hospitality and tourism industry in Covid-19 pandemic**

➤ **Bleisure Travelers and Hotel Work Spaces**

Bleisure travel is a term used to define travel that blends features of both business as well as leisure. It characteristically takes the form of business travelers lengthening the period of their journey, so in order to relish activities of leisure, which may range from relaxation and sightseeing, through to visiting venues of entertainment, hiking, or attending events. For many employees, working remotely has today turn into very normal as well as is predicted to become more than just a transitory trend. A shift speeded by the international crisis of public health, an unparalleled number of prominent establishments with gigantic tech enterprises like Twitter, Facebook, as well as Amazon leading the way proclaimed that they will accept a not only hybrid approach or but also flexible approach to working remotely. In the year 2021 itself, the ratio of workforces all over the globe that are perpetually working remotely was estimated to increase a lot. This means that for bleisure travelers the sectors of hospitality are being used as make-shift offices as well as natives looking for a modification in environment of work. This is an immense opportunity for not only for the hotels but also for the venues of food and beverage to capitalize on the inclination and acclimate their contribution to encounter the needs and wants of this evolving segment; such as free high-speed WIFI, ample plug sockets and great tea or coffee are worthy beginning services.

➤ **Holistic Hospitality, Health and Well-Being**

Wellness tourism can be described as ‘all travel linked with the quest of retaining or improving one’s individual wellbeing’. Due to the COVID pandemic, precautionary medicine as well as self-care are all together influencing right now. The industry of wellness is transmuting into a flourishing market of trillion dollar as well as sectors of hospitality are well capable to take a huge piece of the pie, particularly those with current facilities of spa. In addition to the common spa offering relaxation, there is speedily increasing request for health diagnostic expertise as well as personalized plans of treatment provided by specialists who organize personal or group assemblies to develop healing, vitality, emotional balance, stress management, mindfulness as well as improved sleep.

➤ **Digitalized Experiences of Guest**

Apps are progressively significant in the way hoteliers succeed to provide services to their guests as well as can now regulate many features of the guest cycle as well as experience. Inessential to say, the inclination headed for digital as well as contactless services has expanded new motion from the year of 2020. By tradition, hotel guest fronting services are being offered an overhaul acknowledgements to the further extensive use of technology driven benefits, such as mobile check-in, voice control with biometrics as well as contactless payments. Hotel guests who have become used to to unlocking their laptops as well as smartphones using recognition of facial and fingerprint will almost immediately come to anticipate the same expediency in gaining access to their rooms in the hotel. Inopportunately for the hotel companies eyeing to comfortable them, these advancements may be expensive to connect as well as uphold. If you wish to stay ahead of the moment of time, we recommend you make the investment in digitalization.

➤ **Personalization**

In present era, guests have matured enough to anticipate to be acknowledged as individuals. Hotel companies are going the long way to individually welcome their guests, while devices such as Mailchimp as well as Zoho have created personalized e-mail marketing easily reached to the masses, confirming greatly communications for target viewers. Far beyond simply adding the customer’s name to email greetings, data provides insight into past buying habits, enabling hotels to tailor their offers and promotions, and automatically provide similar services to previous stays. Platforms of technology such as CRM as well as CEM use big data to build one-to-one connections amongst the guest as well as the host at very good scale. AI-powered chatbots have confirmed to be a hotel guest service asset both throughout the process of booking as well as in replying to recurrent questions. Operations of hotel more commonly are progressively designed by the usage of management systems to monitor as well as maximize revenues, relationships with customer, channels, property as well as prominence. In addition to, the increasing significance of predictive analytics, integrated messaging, customer profiling as well as middleware, which strive for to associate any dissimilar systems.

➤ **Experience Economy and Essentialism**

Good quality personalization as well as distinctive experiences is a need of today’s hotel guest. The growth of the independent traveler, impact to the less involvement of the travel agency as well as. Travel guiltiness is absolute. “Less is more”, is somewhat dusty saying, because Minimalism has modernized. The hotel guests are now days very less looking for extravagant shows of wealth, desiring instead to expend wisely, decisively as well as make a constructive influence on the globe. Exceptional experiences that give back to native societies in significant conducts are in request, as are adventurous holidays, relaxation retreats as well as niche hotel properties.

➤ **Strategy of Asset Management**

The approach of asset-light has become predominant in the hospitality sector. The segregation among the operations management as well as assets of real-estate now agrees companies of hospitality to emphasis on their principal business, therefore cultivating competence. It nevertheless encourages surplus difficulty as well as prospective agency obstacles, enlightening the appearance of new varieties of work profiles, such as asset managers. Additionally, new work profiles have appeared succeeding the growing difficulty of the hospitality industry. Similarly, the requirement for competencies of quantitative analysis such as forecasting, budgeting, etc. has also heightened.

➤ **Reality of Virtual and Augmented**

Successively on from the positioning concerning content of visually appeal, it appears only expected that hospitality industry businesses should search for to take advantage of on technologies such as virtual tours, which will artifice up a digital atmosphere for hotel guests to portrait themselves in. Videos which offers 360-degree views of café terraces, ambiance of restaurant, enclosed in locations of hotel beachfront or greenery or, for occasion, are fair the mode to create a hotel company stand out in the competition. As consistently, creating the admittance threshold low is crucial factor to success as broad a viewers as conceivable with material of virtual reality, creating content reachable on a range of appliances, beyond the prerequisite for a VR headset. The hotel guests should be able to use their smartphone with merely point it at true-world artefacts to conjure up further information. Graphical or informational overlays are used by augmented reality usages to enrich in-situ atmospheres. Once the hotel guests have downloaded the relevant app, they can usage this device to entree on opening times of restaurants, analyses or even construct user-generated content or collaborating tourist information maps.

➤ **Take-Away and Ghost Kitchens**

Because of the pandemic here to remain, so majority of the hotels and restaurants are revolving to take away as well as home delivery as an alternative to withstand amongst the lockdown restrictions as well as social distancing. The restaurants of the five-star hotels have all engaged up this alternative to withstand in the Business. Establishments such as Wal-Mart and Amazon and are investigating drone delivery also understood that it was a much economical as well as environmentally responsive alternate to delivery vans. The Industry of hospitality is even not far late with numerous food distributions being execute through drones. Majority startups that were associated to food distribution as well as virtual restaurants succeeded with the beginning of the pandemic. One of such invention for restaurants which is the conception of Ghost Kitchens, in this conception each restaurant compensations a assured fee as rent payment for the kitchen space as well as furthermore compensations commission for each food delivery. Startups such as Karma Kitchen and Doordash are exceptional examples of this conception. Therefore, Ghost Kitchens have a great chance to develop even later the pandemic as online distribution is a customer behavior which will stick from place to place much extended.

➤ **Traveling Less and Staycations**

In 2020 and 2021, travel restrictions have enabled the growth of the staycation. As it may be with global travel is starting back up, among price hikes airlines, requirements of Covid testings as well as the very convoluted bureaucracy which is engaged in going abroad nowadays, various presumed foreign travel either too costly for a huge family holiday or not value the disturbance for the breaks of the weekend of the preceding. Therefore, deciding in preference of the trend of staycation rather, or merely travelling much fewer than levels in pre-pandemic. Actually, there is a numerus of motives vacationists may also be selecting to stay nearby to home, such as for reasons of budget or environment, because of this the current time having seen an increase in outings spent more in local places. It is very fortunate for the people who live in at present picturesque and tourism-rich nation with a pleasing conditions. New experiences are desires of the modern day travelers, because of the speedy advancements of global technology, change in climate as well as remaining dynamics, the industry of hospitality tourism is continuously revolutionize. According to the World Tourism Organization (UNWTO), in the year of 2018, recording the utmost arrival of international tourists, having experienced an extraordinary past in a decade, the hospitality and tourism sector is nowadays definitely faced with immense challenges as well as uncomfortable fluctuations in the aspect of the COVID-19 pandemic. Nevertheless, there are quiet expanding hospitality and tourism trends that can benefit Destination Marketing Organizations (DMOs), tour operators as well as other suppliers of industry to overhaul their businesses as well as witnessing attainment as industry develop into the new normal.

➤ **Sustainable Tourism**

Majority of the tourists consider that individuals make choice of sustainable travel in order to protect the planet as well as preserve it for forthcoming generations. New holidaymakers are accepting this attitude hereafter

making their travel resolutions with the environment in consciousness. For instance, Carbon offsetting, is flattering more prevalent by the day particularly meanwhile holidaymakers want to benefit lessen the influence of the crises of environment. Tourism establishments be able to too back this mission by creating minor but noteworthy modifications. Holidaymakers can leave the use of single-use plastics or else choose to simply use solar for all there requirements of energy. Nevertheless, it's imperative to understand that sustainability is not only related to the environment, it's similarly about constructing a progressive influence on cultures and economies as well as the individuals at the destinations that clientele like to visit. Sustainable tourism is furthestmost expected going to develop, in the period of Covid-19 pandemic. If hospitality and tourism industry play major share in safeguarding sustainability, industry can build the trust as well as loyalty of the group of holidaymakers who are spearheading this movement.

#### ➤ **Transformative Travel**

This is a new trend of tourism that's rapidly achieving a huge popularity. The concept of transformative travel is not just about traveling for leisure but also directing to create a modification in the lives of both others as well as individual. Volunteering expedition are an instance of the involvements which have expanded popularity from this movement. Holidaymakers vacation as well as furthermore fixed separately period to volunteer at their tourism destinations. While it originates to creating a transformation in their individual lives, customers can determine to drive for wellness long weekends where they relish as well as either relax at a nature-filled destination, join a yoga class otherwise join some classes of apprenticeship to acquire a different expertise. There is similarly a remarkable alteration in the holidaymakers' diet, because of this trend. As an alternative of satiate in unhealthy eatables, those who've merged the movement of organic food desire spaces that provides extremely nutritious as well as organic food products. One of the foremost purposes for transformative travel is to be elaborate in something which is noteworthy as well as enhances determination to the journey. Majority of worldwide holidaymakers would consider contributing in cultural interactions to acquire a new expertise, followed by a volunteering trip as well as worldwide job placements. Centered on this inclination, travel companies can emphasis on proposing purposeful and unique activities laterally with their usual or typical products and services.

#### ➤ **Experience Tourism**

The trend of experience tourism is on the upswing now days. This trend is around having an experience of once-in-a-lifetime or acquisition of association of sensation with not only cultures but also nature. As holidaymakers get bored or tired of regular holidays in travel destination, they commence eyeing for an authentic services in their destination of travel. Holidaymakers can without difficulty go for a trademark that will permit them to intermingle with the natives as well as involvement the culture of the individuals. Holidaymakers favor spending extra currency on exceptional services relatively than on material things, thus, if hospitality and tourism sector provides these services, then you're well on your means to attaining this cumulative breed of clientele. Food sampling is considered as one of the best popular experiences. Culinary or food tourism permits holidaymakers to delight in diverse local cuisines, maybe even acquire by what method to prepare some of the recipes as well as intermingle with the individual's customs and traditions in the manner. Rather than staying in hotels, holidaymakers need to experience their travel destinations is by residing with native people. This holidaymakers them an opportunity to intermingle even closer with the native people as well as perceive their approach of life.

#### ➤ **Solo Travel**

Solo traveling is a is considered as delightful as well as self-rewarding that powers you to not only grow but also leaves you pleasure of fully recovered as well as more optimistic. But more individuals are going to travel solo for diverse priorities. Many holidaymakers may need the independence to do whatsoever they need, each time they need, comparatively than be "tied down" to a group of family or friends, or a companion. And holidaymakers may like to traveling alone for their specific individual progress, as well as exploring to some degree profounder from their solo exploration. Majority of solo travelers are moreover choosing for tours which professionally conducted, which is virtuous news for operators of tour and activities. Majority of travelers are dreaming to take full advantage of their "me-time." The hospitality and tourism industry can gain benefit of this by having distinctive proposals to provide to these solo explorers. Maybe hospitality and tourism industry can deliver them a further individual service with one-on-one cooking classes or one-on-one tours. Solo Traveling every so often lonely, but can be eye-opening, uplifting, as well as entertaining. Industry can even think of provides for two individuals where you have the occasion to pair them with an unfamiliar person that may converted their new finest associate. These so travelers even delight in get-together with new folk as well as frequently make long-lasting bonds throughout their travels since impending someone who is alone is much

at ease than impending a group of people. For solo travelers, safety is also a great worry for. The solo traveler should be sure to worry that offers provided by an industry are reliable as well as trustworthy. The notion of being Solo Travel even worse during the journey is not ever amusing for any kind of vacationer.

### **CONCLUSION AND RECOMMENDATIONS**

The essentials of sector of hospitality such as courtesy to detail, personalization as well as offering a distinctive guest services have not transformed and remain to be the potentials accentuated in the business. The retrieval outline displays that individuals are quiet choosing to travel in spite of the constraints not only in domestic travel but also international travel. Travelers are eagerly waiting to spend their reserves on tourism as well as distinctive services at the similar period they have progressed as well as their worries are intensified with respects to healthiness, safety and security as well as environment-friendly choices. As a result, it is very essential to keep contemporary with the business trends, even if you are a traveler coming up to expend your gathered revenue on involvements or a business owner tiresome to remain on best of the cut throat competition. This research investigating over the modern scholarly articles as well as articles on applicable websites collected appreciated understanding as well as data concerning current expansions in the industry of hospitality and tourism during COVID-19 Pandemic, offering 360-degree view of the modern expansions to the readers. Even though research in this arena is comparatively different, upon investigative the progressing tendencies digitalization as well as technology was establish to be a controlling tendency to regulate the provisions of the worldwide industry of hospitality and tourism in the forthcoming. Numerous technologically ambitious startups are associating with organizations of hospitality and tourism as well as serving them prepare for the forthcoming post the pandemic. Every single segment of the business has seen progresses in relations of technology, such as contactless check-in or checkout and payment, contactless distribution of food and beverage to the customer's doorstep, housekeeping service with atomized sanitation, modified service blueprint, cleaning procedures as well as 5 Star Kitchens and Restaurants revolving to progressive techniques of rent out out ghosts kitchens to associating with third-party vendors.

Establishments are captivating a more all-inclusive methodology as well as not only regarding into the safety plus hygiene requirements of the vacationers but are also considering into improving the confidence as well as healthiness of their workforces not only physical but also mental through different training assemblies, this would have been undeveloped in some circumstances if not for the forewarning from the pandemic. As the industry move advancing to the beginning of 2022, the accessibility of vaccines specifies an upgrading concerning towns lifting lockdowns as well as most of the establishments reopening, prohibition on travel being raised as well as social assembly once yet again recommence. Reevaluating the forthcoming of sectors of hospitality and tourism is not comprehensive beyond addressing the advancements of technology in all sectors of the hospitality and tourism industry as well as brand innovative concepts retain developing each single day around the world, this in amalgamation through previously prevailing technology creates to an innovative techniques of impending the disaster of COVID-19. Through quickening these concepts as well as relating them to transform the traditional methods of attending the worldwide nations, the hospitality and tourism industry is assertive itself further into the forthcoming period. Hospitality and tourism companies around the world are being enforced to familiarize otherwise they will have to witness elimination. The authors anticipates that the readers are prepared with the most recent inclinations around the world that are restructuring as well as altering the appearance of hospitality and tourism industry with this research work. In the COVID-19 period, the authors discovered that, traditional styles of welcome as well as standard operating procedure have been switched with precautionary procedures of scanning, sanitizing as well as social distancing. Even though the personal touch is repeatedly misplaced in these measures it is what is anticipated as new normal as well as suitable to not only forefront workforces but also customers.

Nevertheless, personalization continues one of the influential aspects for the sustenance of any service industry, the business has set up techniques to monitor the safety procedures as well as nonetheless quiet provide a distinctive personal service for the customers, industries point out in this research have used numerous procedures of familiarizing to the altering appearance of hospitality and tourism as well as are not only perpetuation but acquisition of modest improvement performance so. The authors even deliver a vision into the behavior of innovative customers this will assist in the estimate of forthcoming inclinations that will modify the appearance of the industry of hospitality and tourism in the coming forthcoming era.

### **BIBLIOGRAPHY AND REFERENCES**

1. Baum, T. and Hai, N.T.T. (2020), "Hospitality, tourism, human rights and the impact of COVID-19", *International Journal of Contemporary Hospitality Management*, Vol. 32 No. 7, pp. 2397-2407.

2. Baum, T., Mooney, S. K. K., Robinson, R. N. S. and Solnet, D. (2020), "COVID-19 impact on hospitality workforce – new crisis or amplification of the norm?", *International Journal of Contemporary Hospitality Management*, Vol. 32 No. 9, doi: 10.1108/IJCHM-04-2020-0314.
3. Dehler, N., 2020. Hospitality's New Normal Must Include Hi-tech, Self-service Tech. <https://hospitalitytech.com/hospitalitysnew-normal-must-include-hi-tech-self-service-tech>.
4. Goodwin, H. (2020), "Latest developments in responsible tourism. Responsible tourism partnership", available at: <https://responsibletourismpartnership.org/2020/04/12/latest-developments-in-responsible-tourism-04-2020/> (accessed 9 September 2021).
5. Haywood, K. M. (2020), "A post COVID-19 future-tourism reimagined and re-enabled" *Tourism Geographies*, Vol. 22 No. 3, pp. 599-609.
6. PricewaterhouseCoopers. (2021, June). PwC's Global Consumer Insights Survey 2021. Retrieved October, 2021, from <http://www.pwc.com/gx/en/industries/consumermarkets/consumer-insights-survey.html>



## Women Entrepreneurs in India-What Chains Their Success?

Satish Kumar and Kanika Thakur

School of Education, Lovely Professional University, Phagwara, Punjab, India

### ABSTRACT

The advent of 21<sup>st</sup> century witnessed the surge in entrepreneurial activities amongst the female sex of India. Where on one side the patriarchy, gender prejudices, low family assistance and cultural biases were still prevailing, women on the other side were taking their entrepreneurial intensities to next level and lifting the veils of entrepreneurship forever, what come may. This paper reviews the changes seen in the perspectives of society in reference to women and their entrepreneurship in past twelve years and the reasons still prevailing in societal mindsets which chain the successful setups of women. It also discusses about number of schemes and governmental supports being taken up to promote and help women entrepreneurs at a large scale.

Keywords: Women entrepreneurship, Indian society/culture, current challenges, governmental support

### INTRODUCTION

Entrepreneurship can be stated as a process of building value through recognition of business opportunities, management of risk taking appropriate to the opportunity and using communication along with management to utilize human resources, financial resources to build a fruitful project. Any individual who owns and hones the skills of bearing greater risk and uncertainties to set up and run a venture can be termed as an entrepreneur. **Robert D. Hisrich and Michael P. Peters (1998) defines**, "Entrepreneurship is the process of creating something new with value by devoting the necessary time and effort, assuming the accompanying financial, psychic and social risks and receiving the resulting rewards of monetary and personal satisfaction and independence."

Entrepreneurship traces back to centuries when the obsidian trading took place amongst various hunter-tribes. This continued for other millennia when the first Neolithic (agricultural) revolution happened and a gigantic shift in the entrepreneurship scale was witnessed. By 3000 BC, when cities started rising and entrepreneurs were specialising in areas like pottery, masonry, carpentry etc, only then people realized how exchanges and trading culture can be formulated in between cities and cultures. Since then, trading of salt, gunpowder, coffee, lemons etc came into existence and resumed for good.

Much before the money invention, barter system was the key but afterwards currency took it by storm. After a long gap of discoveries and transformations, initiation of industrial revolution caused a surge in entrepreneurial activities from small-scale in towns to large-scale in cities. Availability of labor and energy production promoted the activities to large extent and trade became global. Finally, the hit of modern times changed the meaning of entrepreneurship drastically but keeping the core values similar.

Entrepreneurship has been proved to be the catalyst of change specially for the economic reforms and supportive growth. The commencement of the 20<sup>th</sup> century saw the rise in feminism which finally began to make real changes in the female working environment. Female entrepreneurs like Coco Chanel, Olive Ann Beech, and Ma Perkins got a breakthrough. These powerful women built their own brands while fighting for success against discrimination, taboos, unfair remunerations and stigmas plaguing female business owners. Today these brands survive to tell the legacy of some of America's earliest female-preneurs. In India, womanhood has always been suppressed by the male dominated patriarchal society. However, 1960s laid down the foundation of realisation for women to see themselves as bread makers from bread earners. Pottery, home-made eatables' business (papad, spices and pickles etc) and bangle manufacturing etc developed as small-scale business in the homes of thousands of females and artistic skills became a blessing. 1970s also brought in a wave of feminist activism and raising voices against issues like gender inequality, rape, domestic violence faced by women, sati, divorce laws, political representation and land rights could be heard. The wave of women asking for their rights began and the term 'women entrepreneurship' came into existence.

In 1980s, men made it harder for women to survive in the market but still the fames like Vandana Luthra, CEO of VLCC and Kiran Majumdar Shaw, CEO of Biocon were blooming. 1990s came out to be the golden period of independence and around 2 lac women entrepreneurs paved way for themselves, concealing men entrepreneurs in the small box. Due to the shadow of liberalization, globalization and privatization, women were able to build their fortunes in every sector of service and trading in the economy. Eight five-year plans,

**EDP (Entrepreneurship development programmes) and KVIC (Khadi and Village Industries Commission)** were the major governmental supports to empower women in this era.

21<sup>st</sup> century has seen a colossal surge in the numbers of women entrepreneurs, no matter the competition has rose to much higher levels amidst the workplace discriminations, gender inequalities and wage struggles in comparison to the male counterparts. Women are creating benchmarks in the fields of business, media, politics, administration, fashion, social work, research, law and many others. Payment ecosystem, e-commerce, travel, beauty, clothing are some main sectors where women have created verticals for themselves.

The Government of India has defined a women entrepreneur enterprise as, "An enterprise owned and controlled by women having a minimum financial interest of 51% of the capital and giving at least 51% of the employment generated in the enterprise to women"

Women empowerment can be said as a change in the women's life, which enhances her capacity of leading a fulfilling human life. It gets reflected in external qualities (viz. health, mobility, education and awareness, status in the family, participation in decision making, and also at the level of material security) and internal qualities (viz. self-awareness and self-confidence) [Human Development in South Asia (2000)] as quoted by Mathew (2003).

"Empowering women is a prerequisite for creating a good nation, when women are empowered, society with stability is assured. Empowerment of women is essential as their thoughts and their value systems lead to the development of a good family, good society and ultimately a good nation." - APJ Abdul Kalam, Former President of India.

## REVIEW OF LITERATURE

Nayak and Mahanta (2009) revealed the disempowered and inferior status of women as compared to men despite of the consistent governmental interventions and empowerment attempts. The study brought out the reasons like huge gender gap in education and employment, zero or low household decision making power and low mobility of women as the major factors contributing to low social status of women. Two indices, namely, Gender related Development Index (GDI) and Gender Empowerment Measure (GEM) were introduced to calculate the overall improvement and gender disparity. It was found out that the unchangeable attitude of women pertaining to injustice and unfair treatment as a right concept is the stem to their degradation. Consequently, acceptance of unequal gender norms by women are still prevailing in the society where domestic violence, low participation in everything and zero decision making power is terribly affecting women's living standards. A large gender gap exists in political participation also. The study, thus, infers an observation that access to education and employment are the only powerful causes to empowerment and achievement towards the aims. Although, it largely relies on the attitude of the people towards gender equality.

Arora (2012) discusses the relation of globalization and state level openness with per capita income and gender inequality. It studies whether gender inequality is 'lower' in various more open and globalized states in India and showcases potential effects of great liberalization on women like employment issuance, public services, wage gap reduction and price effects. She found that though there might be increased employment in terms of numbers, yet the education access and health still remain inferior to them. Even if the latter are provided, only the equal rights to participate in labour and overall mending of social perspectives will help bring a change.

Khatter and Sapra, (2013), laid emphasis on the correlation of demographic variables and their impact on financial performance of Indian women entrepreneurs. The conducted research assumed a hypothesis that financial performance of women entrepreneurs is independent of the demographic variables and studied a population of 100 women entrepreneurs, while considering the variables like age, education, marital status and family income. The findings obtained using Pearson's chi-square test clarified the extent of dependence, making it visible that financial performance is highly dependent on marital and family status, normally dependent on the age and has zero dependence on educational levels.

Kumbhar (2013) studied the critical aspects of women entrepreneurship in the remote parts of India. The author concluded some major causes responsible for the setback of the women in rural areas like unrealized definite life agenda, imbalance in family and career obligations, zero financial freedom for women, no direct property ownership or collateral; absence of risk bearing capabilities, entrepreneurial skills, awareness, confidence, professional education, mobility; negligence by financial institutions, no contact with successful entrepreneurs and a huge gender inequality issue. He further suggested that making women as mediators of economic growth, consistent hammering of their inspirational minds and conducting awareness programs on a gigantic scale can help curb the situation.

An exploratory study conducted by Reddy and Bade, (2015), presents a detailed description on how SMEs (small medium enterprises) become the backbone of an economy and how Indian women entrepreneurs multiply it by promoting SMEs. This paper is built on assumptions that if motivational factors have any significant influence on women entrepreneurship development and statistics proved the significant impact of motivational factors on development of women entrepreneurs along with suggestions on fostering wealth creation by women entrepreneurs for high economic growth.

Kakkar et al., (2019) conducted a comparative analysis of Indian entrepreneurs with entrepreneurs of top three countries viz. New Zealand, Sweden and Canada as per Master card Index of Women Entrepreneurs (MIWE). The statistics shown low gender discrimination with more supportive financial and emotional structure in the three countries where as India being a developing country still struggles to maintain the decorum because of lack in finance, leadership, inequalities, resource scarcity and low infrastructural developments. New Zealand is found to be the top-ranking nation whose women entrepreneurs are overshadowing men globally.

In the next paper, Korreck (2019) explores the situation and low success rate of female entrepreneurs mainly because of minimal safety, a huge gender gap, biased treatment of women as entrepreneurs, low confidence, very less or no family and financial support and lack of child-care options. This paper studies the factors affecting the performance and interests of women to enter startups and entrepreneurship and lays emphasis on what holds them even after certain technological advancements which is basically

Falguni (2019) mentions the potential recognition or demotivation factors that work in women entrepreneurs' lives. Increase in awareness of personal and social needs amongst women stemming the need of self-dependence in them and thus ultimately boosting economic growth is being talked upon in the paper. Struggles of initial stage like funding, low freedom in movement, dual responsibilities or work and family contribute to the hardships whereas technological and societal revolutions truly are helping in the upliftment of women by building a platform.

As per World Bank (2021) the entrepreneurship indicator built by the expert researches upon several reasons devoting to the stoppage of setting and running of a venture by a woman. In spite of the high score, basic causes like collateral constraints and social norms shape up the choices of women. However, they suggest the enhancement of women's control over finances, bank accounts alongside training them in skills will definitely help in a colossal surge of women entrepreneurs setting their foot in business and shifting the conservative perspectives to modern approaches.

#### **CHALLENGES IN CURRENT SCENARIO**

India has the third largest ecosystem for startups and expecting around 150 unicorns by 2025, as per TOI (Times of India). Women entrepreneurs have seen no growth. Only about 14 percent of Indian women own or run businesses, according to the 'Highlights of sixth economic consensus', conducted in 2014. More than 90 percent of companies run by women are microenterprises, and about 79 percent are self-financed. The question that arises here is what is still chaining the growth of women in a century of full female activism and feminist thoughts prevailing everywhere. As per the findings from a mix of past twenty-year studies and around 30 research papers, some of the current issues that are still a wall in between potential women entrepreneurs and their success and still are found to exist could be;

- Slow processing of governmental assistance
- Women's lack of awareness on legal and provisional constitutions and rights in existence
- Low to zero decision making power in hands of women
- Stigmas like gender discrimination and inferior treatments at every place
- High crime rate and low mobility leading to safety issues at work/public places
- Collateral unavailability, funding problems and no capital
- Absence or low rate of educational provisions in remote areas till date
- Low Managerial capacities or zero skills in effective business management
- Societal stereotyping of good and bad woman and cultural pressures creating negative self-perception.
- Socio-personal problems like economic backwardness, societal attitude, low risk bearing.

- Family support absent in totality, child care issues like juggling between home and family where only women is expected to handle the household chores alone, without family help. If not emotional, then financial issues like low income of parents, basic occupation and basic salary ergo low chances of opting business occur.
- Production and marketing issues for small scale business holders as in low market knowledge, cut throat competition, exploitation by middlemen, corruption in material, labour, trading; lack of export market support, due collection issues etc.

**World bank** built eight indicators as per the 'Women, business and laws,2022' report to measure gender equality globally and different countries were labelled with different indicators in the field of improvement and reforms. Women still suffer because of absence of these indicators worldwide and India lacks in establishment of fair marital grounds, where patriarchy dominates the justice in the institution of marriage.

"We are still highly patriarchal, and disobeying the husband is not possible in most households. Domestic violence is very high, and most matters go unreported" is the verdict of a legal expert who is explaining the gaps in implementation of legislation in India, as stated by the World bank (2021).

### **Governmental Support- Current Scenario**

The main issue responsible for low success rate of women is found to be absence of financial support and most of the startups do not begin or flourish for the reason that funding is a major drawback. Ramesh.B, (2018) explains how women entrepreneurship is being promoted by GOI in current era and the role played by various autonomous, charitable and financial institutions is helping the inspired women seek help and accomplish impossible targets. As per his study, some of the organizations contributing in this direction are,

- National Resource Centre for Women (NRCW)
- Women's India Trust(WIT)
- Development of Women and Children in Urban Area (DWCUA)
- Women Development Cells (WDC)
- FINANCIAL INSTITUTIONS
  - (i) National Small Industries Corporation (NSIC),
  - (ii) All-India Development Banks (AIDBs), viz. IDBI, IFCI scheme of interest subsidy of women entrepreneurs, ICICI, IIBI, IDFC and SIDBI,
  - iii) Specialised Financial Institutions (SFIs), viz. Exim Bank and NABARD,
  - iv) Investment Institutions, viz. LIC, GIC, NIC, NIA, OIC, UII and UTI,
  - v) Regional/ State-Level Institutions, viz. NEDFI, SIDCs and SFCs,
  - vi) Commercial Banks,
  - vii) Co-operative Banks, etc.

Some other programs and governmental loan schemes have also been initiated for the similar purpose as Saraswat and Lathabahn, (2020) also mention these under the schemes for upliftment;

- Annapurna Scheme
- Assistance to Rural Women in Non-Farm Development (ARWIND) schemes
- Bhartiya Mahila Bank Business Loan
- Cent Kalyani Scheme
- Dena Shakti Scheme
- Entrepreneurial Development programme (EDPs)
- Indira Mahila Kendra
- Indira Mahila Yojana

- 
- Integrated Rural Development Programme (IRDP)
  - Khadi and Village Industries Commission (KVIC)
  - Mahila Vikas Nidhi and Mahila Samiti Yojana
  - Management Development programmes
  - Marketing of Non-Farm Products of Rural Women (MAHIMA)
  - Micro & Small Enterprises Cluster Development Programmes (MSE-CDP).
  - Micro Credit Scheme
  - Mudra Loan for Women
  - National Banks for Agriculture and Rural Development Schemes
  - NGO's Credit Schemes
  - Orient Mahila Vikas Yojana Scheme
  - Prime Minister's Rojgar Yojana (PMRY)
  - Priyadarshini Project by Bank of India
  - Rajiv Gandhi Mahila Vikas Pariyojana (RGMVP)
  - Rashtriya Mahila Kosh
  - SBI's Stree Shakti Yojana
  - SIDBI's Mahila Udyam Nidhi Yojana
  - The Women Entrepreneurship Platform (WEP) [Niti Aayog, an ecosystem provider for budding and existing entrepreneurs, partner with SIDBI]
  - Trade Related Entrepreneurship Assistance and Development (TREAD)
  - Training of Rural Youth for Self-Employment (TRYSEM)
  - Udyogini Scheme
  - Working Women's Forum
  - National Level Standing Committee on Women Entrepreneurs
  - National Association of Women Entrepreneur and Executives
  - Kerala State Electronics Development Corporation Limited
  - Kerala Financial Corporation (KFC)
  - Women Industries Programme
  - District Industries Centres

## **CONCLUSION**

Women are the very base of the family as well as nation and can surely contribute to the economic growth in a humongous way. Women entrepreneurs tend to have a highly realistic approach towards the establishment and running of the venture as well as the national institutions. Every human mind, state and country needs to understand the pure concept of how women entrepreneurship can drift the national and global growth to a new space while building various assets for any economy. The leech of traditional mindset still lurking in the conservative human minds needs to be vanished for a better future of women as well as the whole nation. The certain obstacles found out in the paper, mostly involved issues from the patriarchal and financial worlds which consequently effect the personality and business minds of women. Consistent and innovative attempts on the part of family at first, then educational institutions, government and society are mandatorily required for better inspiration, efficient skills, freedom of choice and successful outcomes of the women entrepreneurs yearning to build a fortune.

---

---

**REFERENCES**

1. Arora, R. U. (2012). GENDER INEQUALITY, ECONOMIC DEVELOPMENT, AND GLOBALIZATION: A STATE LEVEL ANALYSIS OF INDIA. *The Journal of Developing Areas*, 46(1), 147–164. <http://www.jstor.org/stable/23215428>
2. Assistant Professor, Falguni. (2019). "Size of Dependent Members in a Family as a Factor Responsible for Women Entrepreneurship".
3. Belingheri P, Chiarello F, Fronzetti Colladon A, Rovelli P (2021) Twenty years of gender equality research: A scoping review based on a new semantic indicator. *PLoS ONE* 16(9): e0256474. <https://doi.org/10.1371/journal.pone.0256474>
4. Bowen, D. D., & Hisrich, R. D. (1986). The Female Entrepreneur: A Career Development Perspective. *The Academy of Management Review*, 11(2), 393–407. <https://doi.org/10.2307/258468>
5. Bullough, A., Guelich, U., Manolova, T.S. et al. Women's entrepreneurship and culture: gender role expectations and identities, societal culture, and the entrepreneurial environment. *Small Bus Econ* 58, 985–996 (2022).
6. Coleman, I. (2010). The Global Glass Ceiling: Why Empowering Women Is Good for Business. *Foreign Affairs*, 89(3), 13–20. <http://www.jstor.org/stable/25680912>
7. Evans Korang Adjei, Rikard H. Eriksson, Urban Lindgren & Einar Holm (2019) Familial relationships and firm performance: the impact of entrepreneurial family relationships, *Entrepreneurship & Regional Development*, 31:5-6, 357-377, DOI: 10.1080/08985626.2018.1514074
8. Fazalbhoy, Sabiha and Menon, Urmila, OECD's Policy for Women Entrepreneurs - A Comparative Analysis for the Indian Scenario (May 01, 2015). *Transnational Entrepreneurs and International SMEs in Emerging Economies: Drivers and Strategies*; ISBN 978-93-84743-81-9 (2015).
9. Hart, Myra & Gatewood, Elizabeth & Brush, Candida & Carter, Nancy. (2003). *Women Entrepreneurs: Moving Front and Center: An Overview of Research and Theory*.
10. Kakkar, Kareena & Chauhan, Akansha. (2019). Challenge for Women Entrepreneurship: A Comparative Study of India with other countries. 6. 472-477.
11. Kumbhar, Vijay Maruti, Some Critical Issues of Women Entrepreneurship in Rural India (May 1, 2013). *European Academic Research*, Vol. 1, Issue 2, May 2013, Available at SSRN: <https://ssrn.com/abstract=2043821> or <http://dx.doi.org/10.2139/ssrn.2043821>
12. Ministry of Statistics and Programme Implementation, "Highlights of the Sixth Economic Consensus", 2014.
13. Moreira, Joana & Marques, Carla & Braga, Alexandra & Ratten, Vanessa. (2019). A systematic review of women's entrepreneurship and internationalization literature. *Thunderbird International Business Review*. 61. 10.1002/tie.22045.
14. Nayak, Purusottam and Mahanta, Bidisha, Women Empowerment in India (December 24, 2008). *Bulletin of Political Economy*, Vol. 5, No. 2, pp. 155-183, 2012, Available at SSRN: <https://ssrn.com/abstract=1320071> or <http://dx.doi.org/10.2139/ssrn.1320071>
15. Ramesh, B. (2018). Problems and prospective of women entrepreneurship in India. *International Journal of Research and Analytical Reviews*, 5 (1), 452-460.
16. Sabrina Korreck (2019). *Women Entrepreneurs in India: What is Holding Them Back?* Observer Research Foundation. 317.
17. Saraswat, Ritwik & Lathabhavan, Remya. (2020). A study on Women Entrepreneurship in India.
18. Shrivastava, R. (2013). Political entrepreneurship of Indian women: challenges and possibilities. *The Indian Journal of Political Science*, 74(2), 233–244. <http://www.jstor.org/stable/24701106>
19. Singh, S., & Saxena, S. C. (2000). Women Entrepreneurs of Eastern UP: Challenges and Strategies of Empowerment. *Indian Journal of Industrial Relations*, 36(1), 67–78. <http://www.jstor.org/stable/27767698>

- 
20. Sruthy. R, Surya Das R., Dr E. Shirley Elizabeth(2019) "IMPACT OF WOMEN ENTREPRENEURSHIP IN INDIA", International Journal of Emerging Technologies and Innovative Research (www.jetir.org), ISSN:2349-5162, Vol.6, Issue 3, page no.178-182, March-2019, Available :<http://www.jetir.org/papers/JETIRAT06024.pdf>
  21. Vadjal, Mateja. (2018). The Influence of Parents on Female Entrepreneurs in Three Career Development Phases. *Management*. 13, 247-263. 10.26493/1854-4231.13.247-263.
  22. World Bank. 2022. *Women, Business and the Law 2022*. Washington, DC: World Bank. doi:10.1596/978-1-4648-1817-2. License: Creative Commons Attribution CC BY 3.0 IGO
  23. Yadav, Vanita & Unni, Jeemol. (2016). Women entrepreneurship: research review and future directions. *Journal of Global Entrepreneurship Research*. 6. 10.1186/s40497-016-0055-x.

## Contribution of Women from North-East India in the Field of Science and Technology

**Biplab Banik**

Department of Chemistry, Tinsukia College, Tinsukia-786125, Assam, India

For decades in India, the field of Science and Technology was primarily in control of males, however, since past few years, several women have contributed significantly in science and have also stimulated others to act in accordance with them. In Indian Agricultural Research Institute (IARI), 50% of the departments—including biochemistry, plant pathology, entomology, nematology, microbiology, agricultural physics, agricultural chemicals and agricultural economics are led by women. As per United Nations particulars, the research & development institutions in India are comprised of only 14% of the total 280,000 scientists, engineers and technologists. Nevertheless, in the research programmes, a third of the PhD awardees is women. Women Scientists are contributing significantly for the rapid progression of the country in all disciplines. For celebrating International Women's Day on March 8, 2020, the Indian government has acknowledged its women scientists to encourage more women participation in the field of science. It's a magnificent course of action to commemorate the great women scientists of India.<sup>1</sup> From cytogenetics to organic chemistry and social sciences, the ministry of women and child development, Govt. of India will establish 11 chairs across various universities in India in the honour of 20<sup>th</sup> century women scientists, including eminent anthropologist Irawati Karve and mathematician Raman Parimala.<sup>1</sup>



Women's Science Congress is a significant step towards nation building and remarkable endeavor to motivate and encourage women to have a powerful existence in the field of science and technology. Women's Science Congress is the most important part as it reflects a range of areas where the intellectual attributes, innovations, ideas and many other things of and for women are given a vibrant platform in promoting science and technology. Let us not forget that behind the simple, docile and humble identity of every woman there is a razor-sharp brain and an uncanny ability to execute and converts thoughts into actions without much effort. If women are given the opportunity and support, they would excel in any field. Through the Women's Science Congress more young female minds can be inspired to be a part of scientific community and to engage themselves in active scientific research. North-east Indian women have significant contributions in the field of science and technology. North-east Indian women are brave, courageous and enterprising and they contribute in maintaining peace and harmony in the region. They take major role in economic activities with local and traditional markets being run by women only. Stating that history has always proven the bravery and courageous nature of North-east Indian women right from the British rule in India. Even in times of turmoil or unrest in the region, the women have always come to the forefront to resolve and bring peace. If such brave women are provided with scientific and technological awareness, then they can contribute immensely in the outstanding development of the nation as a whole. Women's Science Congress is being held to salute the enthusiasm of Indian women and commemorate their contribution in the society. Women empowerment is immensely important for the development of the country. However, in spite of women performing exceedingly well in schools and colleges, very few women make science and technology, very few women make science and technology as their chosen career and due to certain limitations raised by our society, they opt out of their



professional career. The most important step to empower women is remove the gender disparity. Indian women can contribute magnificently both in personal life by nurturing and taking care of their children, sharing experience and knowledge with their children and also in professional life by augmenting scientific skills and temperament and hence developing our society. Now a days, women are getting more conscious of their rights, hence making their best efforts to enhance and upgrade their intellectual capability, positive ethics affirmation to fabricate her own definition resolution of herself and consider herself as a perfect human being without any gender prejudice. Women empowerment through science and technology, has the ability to accredit them to realize comprehend their talents, and power and structure their life in agreement with their innovations and creativity. In this modern era, particularly in the 21<sup>st</sup> century, Scientists, Engineers and Medical professionals play a pivotal role. These professionals in these fields, in turn, will explore ways and means in solving the problems faced by people such as problems in energy, sustainability, the environment, water, food, disease and most importantly in the healthcare sector. Since the percentage of the scientific and technological workforce has been increasing day by day, women at this juncture, need to participate and explore solutions to technical problems as well as for generating employment in Scientific and Entrepreneurship. Women in India face several challenges in moving up the academic and administrative ladder due to systemic barriers and structural factors. Gender equality in scientific laboratories and institutions of higher education is not only about numbers but also about various micro and macro level factors operating at institutional level. There exist various policies and enabling environment in different institutions in India but a common approach or guiding principles to bridge the gender gap is still lacking. In science and technology sector it is difficult to assess and evaluate the merit of existing process/procedures from gender lens. This clearly demonstrates a need for multi stakeholder interventions. While gender equality in science is an important consideration, it is also in the larger interest of scientific progress and society.

Women faced great challenges to get education in science subjects, as there was no college or university in those days to provide science education to female students. They had to request from college to college and university to university to get admission to BSc, MSc, and PhD courses. Table I provides the list of lady crusaders, who could achieve their endeavour despite several hurdles.<sup>2</sup>

**Table-I:** Chronology of Indian Women Achievers in Science and Technology<sup>2</sup>

Sl.No.	Year	Name	Degree/Achievement	Name Institute/Organization
1.	1921	E K Janaki Ammal	BSc (Honours) (Botany)	Presidency College, Madras
2.	1931	E K Janaki Ammal	DSc	University of Michigan, Ann Arbor, USA
3.	1933	Kamala Sohonie	BSc	Bombay University, Bombay
4.	1934	Radha Pant	BSc	University of Delhi, Delhi
5.	1935	E K Janaki Ammal	First Woman Fellow	Indian Academy of Sciences
6	1936	Asima Chatterjee	BSc (Chemistry)	Scottish Church College, Calcutta
7.	1939	Anna Mondiyal	BSc(Honours)	Presidency College, Madras
8.	1939	Kamala Sohonie	PhD	Cambridge University, Cambridge
9.	1944	Asima Chatterjee	DSc	Calcutta University, Calcutta
10.		Radha Pant	First Woman Faculty	Science Department,

	1945		Member	Allahabad University, Allahabad
11.	1947	Urmil Eulie Chowdhury	B Arch	University of Sydney, Australia
12.	1948	Rajeshwari Chatterjee	MS (Electrical Engineering)	University of Michigan, Ann Arbor, USA
13.	1953	-do-	First Woman Faculty Member	Engineering Department, Indian Institute of Science, Bangalore
14.	1953	Shakuntala Bhagat	BTech (Civil)	Veer mata Jeejabai Technical Institute, Bombay
15.	1957	E K Janaki Ammal	First Woman Elected Fellow	Indian National Science Academy (INSA)
16.	1961	Asima Chatterjee	First Woman to get Shanti Swarup Bhatnagar Award (Chemical Sciences)	CSIR, India
17.	1968	Hiriyakkamavar Ilah	PhD	Indian Institute of Technology, Kanpur
18.	1968	Priti Shankar	First Woman Graduate	Indian Institute of Technology, New Delhi
19.	1975	Asima Chatterjee	First Woman General President	Indian Science Congress Association.
20.	1983	Sudipta Sengupta	First Woman Member	The Indian Antarctic Expedition
21.	1984	Sneh Bhargava	First Woman Director	All India Institute of Medical Sciences, New Delhi
22.	1985	Urmil Eulie Chowdhury	First Asian woman to get her name registered to IAWA, USA	Academy to International Archive of Women Architecture (IAWA), Virginia Tech., USA.
23.	1990	Bimla Buti	First Indian Woman Fellow	Third World Academy of Sciences (TWAS), Trieste, Italy
24.	1994	Satyavati, Gawdagere Vedanti	First Woman Director General	Indian Council of Medical Research (ICMR), New Delhi.
25.	2005	Raman Parimala	First woman to be awarded in Mathematics and Physics	Third World Academy of Sciences (TWAS), Trieste, Italy

There has been visible gender discrimination across the globe to accept the active involvement of women in the discipline of science and technology. It took a long time to get admission of women in the scientific community. Initially, women were denied membership and fellowship in the scientific academies. However, the situation improved when women gained admission to higher education. More than 50% of the world's population is constituted of women, yet in most developed countries the achievements of women in science are invisible.

Some of the significant contributions made by women of North-East India in the field of science and technology are briefly highlighted in this paper.

**1. Joyanti Chutia:**



This Indian physicist did her specialization in the field of solid-state physics and plasma physics. Among all Indian women, she was the first women to lead scientific institutions in India. In 2005, she became the Director of the Institute of Advanced Study in Science and Technology (IASST) in Guwahati, Assam, which is the first premier research institution established in North East India. She is an Emeritus Scientist at the Department of Science & Technology in the Government of India as well as the fellow of National Academy of Sciences. She was born in 1948 at Sivasagar, Assam, India.

Dr. Chutia was one of the first girls in her school to opt for mathematics as a main subject. Later on, she completed her B.Sc in physics from Cotton University, Assam in 1967 and completed her MSc in 1969 and Ph.D on a fellowship in 1981 from Dibrugarh University, Dibrugarh. Dr. Chutia taught for some time as a lecturer at Cotton College, eventually deciding to continue with research. Her research focused on the conduction mechanism of thin polymer films After the completion of her Ph.D, Chutia continued her research at Dibrugarh University for another year as a CSIR-postdoctoral fellow. She plunged into the area of plasma physics at the Physical Research Laboratory in Ahmedabad and thereafter connected with the Institute for Plasma Research in Gandhinagar. After few years, she returned back to the Institute of Advanced Study in Science and Technology as a faculty member and established the Plasma Physics Laboratory. She was awarded the Japanese government fellowship in 1988 to work at the Plasma Laboratory of the Institute of Space and Astronautical Science, Tokyo. Chutia's research interests mainly includes biomedicine, material science and biotechnology. Her research has lead the way for the growth and evolution of a long-lasting and compostable cut stitching material from Muga Silk. She is a recipient of various awards such as Durlav Deka Memorial Award, Basanti Bordoloi Award, Sadhani Saurya Award, Ghanashyam Goswami Award, and K K Barua National Award.

**2. Priyanka Das Rajkakati:**



Priyanka Das from Assam has been appointed as the ambassador of “For Girls and Science”, an initiative launched in 2014 that will now see her encouraging girls to take up scientific careers and pursue it to higher education levels. Priyanka Das is breaking the conventional thinking of the society that science is always been dominated by males and science and women are often considered as an unfamiliar coalescence. From all over

the world, 75 high-quality women are selected for the prestigious Homeward Bound Antarctica Mission's fifth edition and Ms. Das has also been chosen along with them. The aim of the mission is to provide support to women from STEMM (science, technology, engineering, mathematics and medicine) background for enhancing their skill in policy-making capacity and leadership ability. Das was brought up in New Delhi and currently settled in France. She is the daughter of Manoj Kumar Das and Dr Ajanta Baruah Das, who hails from Assam. Her both parents have a science background, and due to their efforts, she got exposure into the field at an early age. Das was having interest in various co-curricular activities like dancing, playing violin, sports etc. She also received the best all-rounder award just prior to leaving school. Das remains to be an all-rounder till date and the labels which describe her are, "Aerospace engineer, data scientist, artist, language enthusiast and ambassador for the L'Oréal-UNESCO girls in Science Initiative." Currently, Das is pursuing her Ph.D studies in satellite navigation, in an aerospace company called Safran in France. The topic for her Ph.D is "how to make positioning by GNSS (an example that we all know of is GPS) more precise, in the order of a few centimetre (it is in reality a few metre)". This technology can be highly useful from security point of view level in autonomous cars which are present at one meter distance from each other. Meanwhile, she is also continuing her studies on the feasibility of using Earth-based satellite systems for navigating on the Moon. Apart from this, her role as the ambassador for L'Oréal-UNESCO for Girls in Science Initiative in France is breaking all stereotypical rigid thinking about women working in scientific fields. For example, she said, "I do not spend entire time in a laboratory with a lab-coat-I actually get to be an artist on the side and travel to my heart's content." The scientist is very dynamic and energetic even in her late 20s and is certainly setting an example, for all the girls who are reluctant of selecting the stream, she said, "If you are curious about life, science should naturally come to you." She was also promoted by Gorgeous You India campaign, which kicked off under the initiative of the Shirin Latif, to reach out and to public light the stories of 100 successful Indian women, who could serve as role model for the young generation. Das completed her graduation in physics from St Stephen's College, New Delhi, where she ascertained that her aerospace dream could literally become a reality. After then, she completed her postgraduation from École Polytechnique in Paris and obtained a double diploma exchange from ISAE- Supaéro. With the advancement of her career in the field of science, Das did not surrender her affection for art. She said she always desired to become a professional artist, but due to confusion at the early stage of her career, she couldn't make a balance between both the fields. Another significant milestone in her life was the Caltech Space Challenge 2015, which was a five-day long international student space mission design competition bringing 32 talented and highly-motivated students to the Caltech campus, Pasadena, USA, to take part in a week-long space mission design competition. The participants worked very hard under the guidance of experts from the industry, NASA and academia to design their mission concept from scratch to final proposal. Furthermore, Das also got the opportunity to visit the NASA Jet Propulsion Laboratory (JPL).

### **3. Rural Women From Assam Prepare Products Like Hand Sanitizer, Homemade Mask To Combat covid-19:**

Rural women of Jorhat, Assam have played a significant part in the preparation of various products such as hand sanitizer, homemade mask, and liquid disinfectant with the help of Rural Women Technology Park (RWTP) under CSIR-North East Institute of Science and Technology, Jorhat, supported by SEED Division, Department of Science and Technology (DST), the products distributed freely among family members and poor people in the neighbouring villages to help combat COVID-19 in the area. Professor Ashutosh Sharma, Secretary, DST said, "Meeting a challenge such as COVID-19 needs strong community participation and support. Self-help groups and dedicated NGOs are perfect vehicles in the current scenario for awareness creation, introducing relevant solutions, making and distributing the low-tech items such as masks and disinfectants". Rural women from the region were imparted training in the production of homemade mask from traditional 'Gamocha' (a traditional Assamese cotton towel) by RWTP, Jorhat. For this purpose, around 150 Gamochas were procured and two sewing machines were organized (6 homemade masks can be prepared from one Gamocha). It has been put forwarded that the homemade mask should be distributed to at the rate of Rs.15/- per mask. Beside this, 200 liters of liquid disinfectant (prepared from the raw materials like dettol, ethanol, glycerine, essential oil) is also being produced. The disinfectant will also be distributed freely among the family members and poor people in the nearby village. The women of RWTP were fully trained and later on they prepared about 50 litres of hand sanitizer, 160 litres of liquid disinfectant, which have been distributed among the 60 women participants and their family members. The RWTP also prepared posters and leaflets on 'COVID-19: Do's and Don'ts' in Assamese language for making people conscious about the Corona Virus and precautionary measures to be taken during the pandemic situation.



Liquid Disinfectant



Hand Sanitizer



Homemade Mask from Gamocha

#### 4. Jubilee Purakayastha:



When the Defence Research and Development Organization (DRDO) evolved the anti-COVID drug, there was extra reason for Assam residents to feel joyous and cheerful. A scientist from the Karimganj District of Assam, Jubilee Purakayastha, was among the scientists who pioneered the anti-COVID drug in the DRDO lab. The breakthrough research of the Institute of Nuclear Medicine and Allied Sciences (INMAS)- a lab of Defence Research and Development Organization (DRDO)- in collaboration with Dr Reddy's Laboratories (DRL), Hyderabad has led to the discovery of an oral drug 2-deoxy-D-glucose (2-DG) for the treatment of moderate to severe coronavirus patients. Clinical trials have proved that this molecule assists in the faster recovery of hospitalized patients and reduces supplemental oxygen dependence.

Jubilee did her schooling at Mahisasan School, followed by Karimganj College. She did her PhD from the North East Institute of Science and Technology (NEIST) in Jorhat, Assam and joined the Defense Research Laboratory of DRDO in Tezpur as a scientist in 2008. The daughter of Lt Sudarshan Purakayastha and Mrs Binoy Kumari Purakayastha, Jubilee said she was inspired by her mother's smile and she would continue to serve the nation. Pursuing the Prime Minister's address to the nation for the discovery of drug made in India,

which can fight against the pandemic, DRDO started the great initiative of evolving of an anti-COVID drug and later on they could successfully implement the therapeutic application of 2-DG drug. In April 2020, during the first wave of the pandemic, INMAS-DRDO scientists conducted laboratory experiments and observed that 2-DG drug performs at high rate against the SARS-CoV-2 virus and inhibits viral growth of disease. Based on these results, the Drugs Controller General of India's (DCGI) Central Drugs Standard Control Organization (CDSCO) permitted a Phase-II clinical trial of 2-DG in COVID-19 patients in May 2020. As per the efficacy trends, the patients treated with 2-DG showed faster symptomatic cure and recovery than Standard of Care (SoC) on various endpoints. Compared to SoC, a remarkably commending drift (2.5 days difference) was observed with reference to the median time for attaining regulating of specific particular necessary symptoms parameters.

## 5. Amiya Rajbongshi:



On International Day of Women and Girls in Science, Dr Deepa Agashe, Assistant Professor, National Centre for Biological Sciences, Tata Institute of Fundamental Research, Bengaluru, tweeted a touching message, saying, "Science is for everyone and needs everyone. I love being a scientist and waking up every day with the opportunity to ask questions to understand the world. Join us in appreciating, inspiring and supporting female scientists." In her small speech, Agashe, summarised her pride, passion and also subtly hinted at how our world needs science, and science needs women and girls. The pride and passion pointed out by Agashe is the connecting bridge among all the other nine acclaimed women performers in the field of science and technology whose achievements were acknowledged and were felicitated by the President last year. The awardees included Dr Amiya Rajbongshi, retired vice-principal, North Lakhimpur College, Lakhimpur, Assam, who won the National Award for magnificent efforts in Science and Technology Communication through print media in 2020, and Dr Uma Kumar, Professor and Head, Department of Rheumatology, AIIMS, New Delhi, who was honoured with the National Award for Outstanding Efforts in Science and Technology Communication in the electronic media. Apart from Agashe, Dr Niti Kumar, Scientist, Central Drug Research Institute, Lucknow, and Dr K Geetharani, Assistant Professor, Department of Inorganic and Physical Chemistry, Indian Institute of Science, Bengaluru, were honoured with the SERB Women Excellence Award last year. Dr Shalini Gupta, Associate Professor, Department of Chemical Engineering, IIT, Delhi, and Dr Shweta Rawat, Scientist, Defence Institute of Physiology and Allied Sciences, DRDO, Delhi, were conferred the national award for young woman showing excellence through application of technology for societal benefits. The three women researchers who were honoured with the Augmenting Writing Skills for Articulating Research (AWSAR) Award included Dr Joyita Sarkar (in the Post Doctoral category), S. Chris Felshia and ML Bhavya (both in the Ph.D Scholar category). Many other women from all over India were AWSAR awardees in the PDF category.

Rajbongshi owes it all to her parents - father Biren Phukan and mother Lakhima Phukan. After matriculation, she joined cotton college in guwahati, graduated in 1968 and obtained first class and also secured first position in Assam. She did her master's degree from Gauhati University in 1970 in first class, again obtaining the first position in the state and Ph.D from Osmania University, hyderabad." She was inclined towards teaching and so joined the North Lakhimpur college as a teacher. She enjoyed teaching profession by visiting different villages and bringing science to the common people by being associated with science societies. She was trying to inculcate scientific temperament in young minds of students. Rajbongshi mentions her husband, Dr. Mukunda Rajbongshi, as her main support system. "His active involvement in the pursuit of knowledge and his

commitment towards serving the society has always been an inspiration for me," she says, beaming with pride. Rajbongshi has a vital point to add to the role that women have played in science. "From Marie Curie, Rosalind Franklin to Kalpana Chawla, history speaks of the success stories and the unfailing attitude of women and their commitment towards science. If observed at the grassroots level, women's role in science has challenged society's narrow shackles. Women uphold the responsibility of moulding the family, the society and then the nation at large. Therefore, we must try and imbibe a scientific temper in them early on so that they can mould the younger ones. Women can also use science to challenge superstitious and help make the society move forward. "Further, when women are actively involved in scientific endeavours, they act both as pioneers and role models for thousands of other women," says Rajbongshi. accordingly." Humbled at receiving the national award, Rajbongshi says, "It is indeed a great honour for me. It recognises my consistent efforts in building a scientific temper among the masses. This recognition is also an inspiration that instils the courage to commit to the goal." The pandemic was a challenging one, both mentally and physically, for all of us. But Rajbongshi got ample time to complete the remaining part of the translation of "Origin of Species" by Charles Darwin and is currently working on the publication process. She plans to work more on spreading scientific awareness among the masses and reaching out to more people through her efforts.

#### 6. Nidhi Sharma:



Nidhi Sharma, a woman scientist from Assam has brought laurels to the state as she is associated with India's ambitious lunar mission **Chandrayaan-2**. The young scientist hails from Tinsukia's Na-Pukhuri area in Assam. She is a space scientist in the Indian Space Research Organization (ISRO) and she played a pivotal role in the successful launch of **Chandrayaan-2**. She is holding a very important position in ISRO. Nidhi married Dipakar Deb who is an engineer by profession in the month of January 2019 and since then they have been staying in Bengaluru. It may be mentioned, ISRO's lunar mission started on July 22<sup>nd</sup>, 2019 and as per schedule, the Vikram lander was about to soft-land in the southern part of moon's surface on September 7<sup>th</sup>, 2019 at around 1:30 to 2:30 am. On September 8<sup>th</sup>, 2019 the orbiter of Chandrayaan-2 located the lander on the moon's surface. After Chandrayaan-1, Indian Space Research Organisation (ISRO) developed the second lunar exploration mission, Chandrayaan-2. All three components of Chandrayaan-2 consisting of a lunar orbiter, the Vikram lander, and the Pragyan lunar rover, were developed in India. The primary scientific purpose is to survey the location and abundance of lunar water via Pragyan, and ongoing analysis from the orbiter circling at a lunar polar orbit of 100×100 km. The mission was launched to the Moon from the second launch pad at Satish Dhawan Space Centre on 22 July 2019 at 2.43 PM IST (09:13 UTC) by a Geosynchronous Satellite Launch

Vehicle Mark III (GSLV Mk III). The craft reached the Moon's orbit on 20 August 2019 and began orbital positioning manoeuvres for the landing of the Vikram lander. Vikram and the rover were scheduled to land on the near side of the Moon, in the south polar region at a latitude of about 70° south at approximately 1:50 am on 7 September 2019 and conduct scientific experiments for one lunar day, lasting two Earth weeks. However, at about 1:52 am IST, the lander deviated from its intended trajectory at around 2.1 kilometres (1.3 mi) from landing, and lost communication.

#### 7. Sudeshna Boro Saikia:



For as long as civilisation has existed, human beings have looked upon the cosmos with wonderment. Over time, our questions about the cosmos have evolved to consider our little place in the universe. Truly, why is Earth special? It is the only planet we know that harbours life. Scientists are trying to figure out properties that make Earth habitable. One such astrophysicist, Dr Sudeshna Boro Saikia, is studying the atmospheric conditions for habitability. Currently, at the Institute for Astrophysics (IAU) in Vienna, she studies space weather to uncover clues to this question. The exploration started with her PhD research. Sudeshna described her work on 'stellar magnetic cycles' at the Georg August University of Göttingen. What is a stellar magnetic cycle? Stars are largely made of gas and plasma that constantly move to create a magnetic field. The magnetic field of a star often changes polarity in cycles! These polarity changes are accompanied by violent storms and volatile activity in the stars. This is true for our Sun too! Every 11 years or so, the magnetic field turns over after 11 years or so and the North and South poles of the Sun shift. These changes on the Sun's surface affect the Earth too. Volatile activity on the Sun's surface may cause disruptions to electrical grids and radio on Earth and damage satellites, limiting their lifetime. They can also mean exposure to harmful radiation for the astronauts in space. By studying the solar cycles, we can forecast disruptions in time and safeguard satellites and astronauts in space. Sudeshna worked on detecting the magnetic cycle of stars similar to our Sun, with a focus on the effect of the rotation of a star. Using complex techniques in astrophysics, Sudeshna and her team were the first to detect a sun-like magnetic cycle in 61 CygA, a dimmer and smaller Sun-like star, with a cycle that lasts 7 years. When Sudeshna was around seven, a local boy from her town went to Trinity College, University of Cambridge, to study mathematics. When he returned with the distinction of Wrangler (the highest honour for undergraduates with a Mathematics degree from Cambridge), he drew a large crowd at the local auditorium for his talk. Sudeshna was in the audience that day. Today, Dr Anupam Saikia is a Professor of Mathematics at IIT Guwahati. Sudeshna recalls that it was a rather inspirational moment for her. Someone from her town achieving the highest honours from Cambridge helped her believe that she could follow the same path too. The adulation and praises from the crowd also helped!

Fortunately for her, Sudeshna was always surrounded by science and STEM. Since both of her parents were academics, she was surrounded by books on science right from childhood. She remembers reading about the Special Theory of Relativity and time travel in an Assamese book for the first time. Prof. J. Narliker's books further caught her eye. Sudeshna recalls an annual mobile book fair where they could find all kinds of books. She could get her hands on international publications, publications from the Soviet Union and Assamese science magazines, to feed her curiosity. A turning point for her was obtaining access to Google in its infancy, in the late 90s and early 2000s. A new world of knowledge had opened up for her! Although the local language magazines evoked curiosity, they would leave unanswered questions. She remembers calling up the publisher to find out more about the European Space Agency and was directed towards Google. Soon after, she would frequent cyber cafes and look for answers to her queries. Sudeshna mentions, "When I found that I could find information about anything, I was overjoyed!"



Sudeshna acknowledges that she is uncommonly privileged. “I have been particularly lucky to find amazing and helpful mentors, right from my early days”. She recalls one of the largest influences in her was a professor at Glasgow who helped her apply for PhD positions during her master’s. With time, her interests grew and she moved from studying stellar magnetic cycles to searching for clues on what makes a planet habitable. Her focus shifted to stellar winds and space weather. Stellar winds are a high-speed flow of material ejected from the stars. Consisting of a wide variety of materials, these winds are complex phenomena and not yet understood. Stellar winds are often studied using advanced computational techniques and sophisticated telescopes. Sudeshna also studies UV radiation; a heavy contributor to atmospheric loss. In the upper planetary atmosphere, high energy UV photons help atmospheric molecules escape more easily. Her experience in multi-wavelength physics as well as the skills she picked up during her PhD serve her well in her quest for her answers today. Sudeshna is a part of multiple working groups for young researchers at IAU. One of these is building a platform for young researchers to unite. Reading stories about Marie Curie revealed sociological impacts of gender identity to Sudeshna. Her identity as a woman researcher remains important to her. She advises young women researchers to overcome inhibitions towards networking. She says, “there are a lot of good people and opportunities out there and we need to be proactive in finding them.” Sudeshna is hopeful for the future of Indian Science, especially for students coming from the NE. She feels that while there are still gaps in the systems (better curricula and teaching methodologies are needed), she can see some progress being made. She feels the system needs to work on its flexibility to adapt to new things. “We need to stop being stuck in the past and limit students to textbooks written decades ago.” She also believes there is a need to move beyond marks and scores as judgement criteria. She says, “These changes will take time, but as long as we are on the path ahead, the future of Indian science is in good hands!

#### 8. Anwasha Borthakur:



The young scientist hails from Tinsukia’s Gellapukhuri area in Assam. Anwasha Borthakur is a Marie Skłodowska-Curie Postdoctoral Fellow at KU Leuven, Belgium from January 2019. Her research focuses on electronic waste policies in India, South Africa and the EU. Prior to joining KU Leuven, she completed her PhD at Jawaharlal Nehru University (JNU), New Delhi in 2017. Anwasha has been working on electronic waste in the global South for the past ten years. She co-teaches the course on Global Environmental Politics with Prof. Katja Biedenkopf. She has published 67 Research papers in various National and International Journals of repute. She has authored various books on Environment related issues. She has excellent skills and expertise on Environment, Sustainability, Environmental Management, Sustainable Development, Environmental Pollution, Environmental Studies, Environmental Impact Assessment, Environmental Analysis, Environment Protection. Her father, Dr. Achyut Borthakur retired as Head, Department of History, Tinsukia College and her mother Ms. Anjana Goswami retired as Vice-Principal of Tinsukia College. Her husband Dr. Pardeep Singh is Assistant Professor at University of Delhi. Dr. Borthakur has contributed immensely in the awareness and management of Electronic waste (E-waste) and bioremediation of Petrochemical wastes.

#### 9. Mausumi Goswami:



A young scientist from the Karimganj District of Assam, she did her schooling from Girl's Higher Secondary School, Karimganj. Then after doing her graduation from Karimganj College, she joined IIT Guwahati for M.Sc. She completed her PhD from Indian Institute of Science (IISc) Bangalore. She did her Post-doctoral studies from Canada. She has been trained in techniques of Physical Chemistry including instrumentation and microwave spectroscopy with research interest which spans from the discipline of atmospheric chemistry, helium nanodroplets to interstellar chemistry. Currently she has been working as Assistant Professor at VIT, Vellore, Tamil Nadu. Her husband Dr. Banikanta Sarma, is Assistant Professor in the discipline of Chemistry at Jawaharlal Centre for Advanced Scientific Research (JNCASR), Bangalore.

**10. Sarungbam Bimola Kumari Devi:**



Bimola Kumari (left) receiving Padma Shri Award from President Pranab Mukherjee

Sarungbam Bimola Kumari Devi was born in Manipur, India. She is a doctor and the Chief Medical Officer of Imphal west region, Manipur. Since 1979, she has been serving in the Manipur state medical service, substantially functioning in the rural areas and has led the food safety office when Narendra Modi, the Prime Minister of India, visited the state. Kumari was honoured by Dr. B. R. Ambedkar International Award in 2014 and with the Padma Shri, the fourth highest Indian civilian award by the Government of India in 2015.

**11. Jenita Mary Nongkynrih:**



In 2011, ISRO had awarded the prestigious Young Scientist Merit Award to Jenita Mary Nongkynrih, a space scientist at the North Eastern Space Application Centre (NESAC), Umiam (Barapani), for her urban information system project in the North East. The award carries a citation and cash of Rs 50,000. Jenita is a resident of Mawlai Mawroh locality of Shillong city. She did her primary schooling at St. John Bosco Girl's High School, Cherrapunjee and continued her study at St. Mary's High School and College. She completed her Master from North Eastern Hill University. She has specialized in Urban studies, Disaster Management and Natural resources management. She has contributed to the project on National Urban Information System-10K for the North Eastern region. Her technical contributions in urban planning for towns in Meghalaya are worth to mention. She is also involved in national projects for natural resources management in Meghalaya. Her major accomplishments in disaster management are the vulnerability and risk analysis for different hazards in three different urban areas and one district of Assam. She has also chipped in for the project on National Urban Information System-10K for the Northeast as the principal investigator. Nongkynrih's other contributions are in urban planning and national projects for natural resources management in Meghalaya. She has inspired young people to build their career in space-based applications.

**12. Sangeena Salam:**



She completed her Master's degree from University of Mysore, India and PhD from McMaster University, Canada. She has PhD research experience in development of drug screening platform for the neurodegenerative Parkinson's disease model. Currently she is Postdoctoral Associate from Rutgers University, USA and she has Postdoctoral Associate research experience in aging. She is a dynamic and versatile scientist, contributed in a successful collaborative multidisciplinary project - performed drug assays, molecular experiments and fabrication of prototype chip devices. Excellent understanding of molecular biology, drug metabolism, physiology and pharmacokinetics. Her research interests include understanding molecular mechanism of aging, molecular biology experiments, molecular cloning, imaging, microscopy, PCR, sequence analysis, CRISPR technologies, microscopy looking at the neuronal cells, characterizing aging morphology of the neurons.

**13. Role of Tripura Women in Agroforestry**

Agroforestry was recognised as a marked area in agricultural science due to the profits acquired from sustainable combinations of woody perennials and annual crops amalgamated with animal husbandry.<sup>4</sup> It is the most self-contained and sound system as it involves the growing of crops either together or in rotation maintaining the ground cover permanently. Involvement of women is essential to agricultural production and is responsible for preserving the small stock husbandry. Women are also the prime users of various forest products from fuel wood collection to the knowledge about the medicinal value. Women group are considered to be crucial in the agroforestry system. Women are playing noteworthy activities in managing the family needs by participating in various agroforestry practices. The involvement of women in conservation management shall bring profit for overall conservation of forest resources. The components which provide higher benefits must be introduced and practiced in a sustainable way. The problems and recommendations are heard and put into action for better development and to ensure better health and harmony. The versalities and compatibility of agroforestry practices has provided better welfare of the society for overall community development. Women's involvement is also fundamental for maintaining the agricultural production and other management activities. Thus, women are seen to take part in vital activities in fulfilling the family needs by engaging in various works. For women empowerment in the state, their significant contribution in agroforestry should be stimulated and motivated. The investigation of role of women in the traditional agroforestry system has become very popular as the dissimilarities are observed in the deflection of labor and management and receiving various types of products. Many had conducted a successful uncovering on the contribution of women in the success of any system from planting to final destination for self-applu or for sale.

**14. Sapam Ranjita Chanu:**



She has completed her PhD from Indian Institute of Science (IISc) Bangalore in 2013. She was Post-Doctoral Research Fellow Ulsan National Institute of Science and Technology, South Korea. She was also Post-Doctoral Research Associate at University of Strathclyde, Glasgow, United Kingdom. Her research work is based on designing of vacuum chambers for miniaturized cold atom experiments, characterisation of instruments, building different class of lasers, optics and magnetic, electro-optics etc. A young Manipuri woman physicist, Dr Sapam Ranjita Chanu, who is currently a postdoctoral fellow at the Atomic and Optics Lab, UNIST, Korea, has been awarded the prestigious Marie Curie Postdoctoral Fellowship working on precision inertial measurement with cold atom group at Paris, France instituted by the European Commission. Dr Ranjita is the daughter of Sapam Babu of Khongman Okram Chuthek, Imphal East, and the wife of Dr Tomba of Yumnam Huidrom, who is also a scientist working in South Korea. The Marie Curie Fellowship will grant her an opportunity to work in a leading laboratory in Paris for a monthly remuneration of 4500 Euros along with allowance of 600 Euros (approximately 3.62 lakh INR in total). She has worked mainly on the development of optical resonators and realisation of frequency control system of high stability. I enjoy testing and designing as well as characterisation instruments including optical, electronics etc. Image analysis from cavity and optical interferometers, laser spectroscopy. Currently she is working at Centre for Quantum Technologies, Singapore on Barium ion precision measurement and developments of the Lu ion atomic clock. Surface ion trap in Cryogenic environment for Quantum Computation.

**15. Mingkee Achom:**



She completed her B.Sc from Assam agricultural University, Jorhat, Assam. She did her M.Sc from University of Agricultural Sciences, Bangalore in Plant Biotechnology and Plant Molecular Biology. She completed her PhD in Molecular Plant Genes from University of Warwick, United Kingdom. She did one project on analysis of 3D confocal images of plant roots using Morphographx to investigate cellular patterning and generated cellular level atlases of developing roots with network analysis using Cytoscape and graph theory at University of Birmingham, United Kingdom. Currently, she is pursuing her Postdoctoral Research at Cornell University Ithaca, New York, United States.

**16. Bijjalaxmi Athokpam:**



She completed her PhD in Theoretical Chemistry from Indian Institute of Science (IISc) Bangalore. Currently she is doing her Post-doctoral research at Ecole Normale Supérieure de Paris, France.

**17. Grace Lhaineikim Chongloi:**



She did her M.Sc from Delhi University and PhD from Indian Institute of Science (IISc) Bangalore. Currently she is pursuing her Post-doctoral studies from Weizmann Institute of Science, Weizmann, Israel.

**CONCLUSION**

It is a painful commentary on traditional prejudice against women, where their identity and rights have been marginalized in every country and at every level of society. It is a story of changing status of women in the modern world. The paper is a fascinating blend of history, biography, science and gender studies. It will serve as a platform to showcase the glory of Women Scientists in North-East India. It will serve as a source of inspiration to younger generation to be more creative and innovative. Author sincerely hopes that the document will be able to initiate passion and spark for future budding scientists to transform their dreams in to reality.

**REFERENCES**

1. <https://www.shethepeople.tv/news/11-chairs-women-scientists-names/>
2. Chattopadhyay A., Women Scientist in India-Lives, Struggles & Achivements, **2020**, ISBN-978-81-237-8144-0, 1<sup>st</sup> Ed., 1-504.
3. [https://www.ias.ac.in/Initiatives/Women\\_in\\_Science/The\\_Women\\_Scientists\\_of\\_India](https://www.ias.ac.in/Initiatives/Women_in_Science/The_Women_Scientists_of_India)
4. Debbarma J., Taran M., Deb S. Oct. Jour. Env. Res. **2015**, Vol. 3(4): 343-351.

## Di-Biotin-RGD: A Novel ARG-GLY-ASP Derivative with Diagnostic and Therapeutic Potentials against Breast Cancer

Bonaventure Mujiyambere<sup>1</sup>, Priyadharshini Thangavelu<sup>1</sup>, Kaavya Gunasekaran<sup>1</sup>, Viswanathan Sundaram<sup>1,2</sup>, Anusuya Nagaraj<sup>1</sup>, Akshayadharshini Kariselvan<sup>1</sup>, Sreelakshmy Sureshkumar<sup>1</sup>, Sangita Sharma Mehta<sup>3</sup>, Suja Samiappan<sup>\*1</sup> and \*Suja Samiappan

<sup>1</sup>Department of Biochemistry, Bharathiar University, Coimbatore, India

<sup>2</sup>Bharathiar Cancer Theranostics Research Centre – RUSA 2.0, Bharathiar University, Coimbatore, India

<sup>3</sup>Department of Pathology, KMCH Hospitals, Coimbatore, India, Professor and Head, Department of Biochemistry, Bharathiar University, Coimbatore – 641 046, Tamil Nadu, India

### ABSTRACT

Breast cancer is the foremost cause of cancer-related death in women worldwide. To improve its diagnosis and treatment beyond conventional tools, molecular analysis was adopted and resulted in various successful applications. But their limitations are dependent on the type of ligands chosen to interact with the cellular receptors, the strength of binding and most importantly, the involvement of the receptor in various stages of cancer development. One pair of ligand and its receptors has a high chance of success as this combination ticks most of the requirements. RGD motif and RGD recognizing integrins have been targeted for both diagnosis and treatment. The common molecules used for cancer diagnosis and treatment are cilengitide an angiogenic inhibitor, fluciclatide a PET radiotracer and iRGD a delivery tool for anti-cancer agents. But, even though RGD tripeptide is promising, it needs to be modified to bypass its natural limitations including the need for a fourth amino acid to stabilize the binding and give specificity to their interaction. A high flexibility in its conformational structure results in unstable interactions with integrins and the possibility to be digested by exopeptidases if the terminal ends are free. In this study, we used RGD tripeptide and then blocked the free terminal ends using biotin tags. The presence of biotin tags was targeted by using streptavidin attached HRP enzyme and FITC as fluorophore to perform qualitative and quantitative analyses including diagnosis both in-vitro and ex-vivo. The therapeutic analyses showed improved cytotoxic effects against MDA-MB-231 cells with an IC<sub>50</sub> of 28.3 ± 4.21 μM and the main type of cell death was found to be apoptosis.

Keywords: RGD tripeptide; peptide biotinylation; molecular diagnosis; molecular treatment.

### ABBREVIATIONS

DMSO	-	Dimethyl sulfoxide
EDC	-	1-Ethyl-3-(3-dimethylaminopropyl)carbodiimide
FMO	-	Frontier molecular orbital
HOMO	-	Highest occupied molecular orbital energy gap
IC <sub>50</sub>	-	50% inhibitory concentration
ITGB1	-	Integrin beta 1
LUMO	-	Lowest unoccupied molecular orbital energy gap
MTT	-	3-(4, 5-dimethylthiazol-2-yl)-2, 5-diphenyl tetrazolium bromide
OD	-	Optical density
RGD	-	Arginyl glycyl aspartic acid
TMB	-	3,3', 5,5'-Tetramethylbenzidine

### 1. INTRODUCTION

Breast cancer is the most diagnosed cancer with the highest mortality among women in India and worldwide (Siegel et al., 2018). It also occurs in men who are more frequently hormone-receptor positive. It is diagnosed in men at an older age than in women (Gupta et al., 2015). The initiation of the breast carcinogenesis usually involves a combination of environmental, genetic and epigenetic alterations and begins from the malfunctioning of ducts leading to invasive ductal carcinoma or also begins in the glandular lobules or other tissues in the breast (Sadikovic et al., 2008; Safdar et al., 2019).

The epithelial cells of mammary gland are anchorage dependent cells and they need integrin-mediated attachment to extracellular matrix (ECM) or cell-cell interactions for the cell wall to proliferate in response to the growth factors (Schwartz et al., 2001). The luminal cells that lines alveoli and ducts are surrounded by the myoepithelial cells that form basal cell layer which are in contact with the basement membrane composed of laminins and collagen IV (Nelson et al., 2006). This has a complicated integrin expression and is regulated temporally and spatially as gland develops through involution, pregnancy and lactation (Taddei I et al., 2003). In the absence of the cell adhesion, it can undergo a form of apoptosis – anoikis (Frisch et al., 1997). Myoepithelial cells make more contact with ECM and their integrin expression levels are higher in this lineage (Taddei et al., 2003).

Integrins are heterodimeric adhesion molecules and receptors of an extracellular matrix ligands. They are required for the cell-substratum and cell-cell communications for the correct functioning of cells. Besides this they have a greater role in tumor cell migration, invasion, proliferation, and survival of tumor cells (Desgrosellier et al., 2010). Integrins are found on the surfaces of both the tumor cells and all other cells in the tumor microenvironment (TME) and also play a role in cancer progression. Their expression levels are altered in breast cancer cells (Pignatelli et al., 1992).

The Arg-Gly-Asp (RGD) tripeptide, fully noted as Arginyl-Glycyl-Aspartic acid, was discovered in 1984 where it was described as the ‘highly conserved minimal integrin recognition sequence’ in fibronectin (Pierschbacher et al., 1984). RGD is the most expressed binding motif in interactions of ECM proteins with the integrins (Nieberler, M et al., 2017). The finding of RGD sequence has stimulated the search for peptidic molecules to inhibit interaction of the ECM proteins with integrins and to control the pathophysiological features of integrin subtypes (Pierschbacher et al., 1984; Heckmann et al., 2007; Kapp et al., 2017).

Studies have shown that tumor cells like MCF-7 cells and MDA-MB-231 expresses RGD-receptor integrins on the surface and the RGD peptide specifically binds on their surfaces and in return increases apoptosis and cell cycle arrests in G1 to S phase (Hong et al., 2000). This is because the peptide acts as integrin analogue, inhibits ligand-binding and blocks integrin functions (Wanhua et al., 2006). It can bind to tumor endothelial cells, tumor cells in-vivo and tumor cells in-vitro, it can also be internalized by the tumor cells (Hong et al., 2000; Zitzmann et al., 2002). The selectivity and activity of the peptide ligands to various integrin subtypes was controllable by RGD flanking residues, cyclization, N-methylation of the peptide bonds and chirality of amino acids (Gurrath et al., 1992; Haubner et al., 1997; Chatterjee et al., 2013). The different functions of RGD-binding integrins in cancer biology and availability of small molecule ligands made it an attractive in-vivo target for molecular imaging of cancer (Niu et al., 2011).

## 2. MATERIALS AND METHODS

### 2.1. Synthesis of a Di-Biotinylated RGD Derivative

The synthesis of RGD derivative with 2 biotin tags attached on each of its terminal ends was accomplished in two phases. First phase, the attachment of biotin tag on C-terminal end was performed as previously described (Nakajima and Ikada, 1995). RGD tripeptide solution was prepared in 0.1 MES (2-N-morpholinoethanesulfonic acid) buffer at pH 5.5 (5mg/ml) and mixed with biotin hydrazide solution prepared in DMSO (13 mg/ml). The two solutions were mixed, then EDC solution (10 mg/1 ml in distilled water), and the mixture was incubated overnight at room temperature with constant agitation. The formed C-biotinylated RGD derivative was purified in PBS buffer using a single-sided magnetic biodialyzer and a cellulose acetate membrane with a molecular weight cutoff of 500 Da.

Second phase, the attachment of biotin tag on the remaining N-terminal was carried using a modified method previously reported (Miller et al., 1997). The solution of C-biotinylated RGD derivative was mixed with Biotin-NHS solution (20 mg/ml in PBS) and the mixture was incubated overnight at 4°C. The separation of biotinylated RGD derivatives with other byproducts and unreacted samples was done by washing with ether and recrystallized with 2-propanol then filtered and stored 4°C.

### 2.2. Physicochemical Characterization of Biotinylated RGD Derivatives

#### 2.2.3. Reverse-Phase High Performance Liquid Chromatography

The purification of Di-Biotin-RGD was performed using preparative high-performance liquid chromatography (RP-HPLC) with PDA detector (Shimadzu LabSolutions, USA). HPLC solvent was prepared using 0.1% TFA in HPLC grade water and acetonitrile in the ratio of 60:40 (v/v). After the filtration of the Di-Biotin-RGD solution with 0.45 µm membrane filter, the sample was injected and the solution was eluted at the flowrate of 1 mL/min. The column eluate was monitored at 215 nm and the final eluted fraction was collected.

### 2.2.1. Fourier Transformation Infrared Spectroscopy

The particular absorbance of various groups was used to confirm the attachment of biotin to the terminal ends of RGD tripeptide by using FTIR spectroscopy (FT/IR-4700 type A, Jasco, Japan). The sample of Biotin, RGD tripeptide and Di-Biotin-RGD were prepared in deionized water. The FTIR spectra were analyzed by scanning between 4000 and 400  $\text{cm}^{-1}$  with a resolution of 4  $\text{cm}^{-1}$ .

### 2.2.2. UV-Visible Spectroscopy

The optical absorbance of Di-Biotin-RGD was analyzed using Multiskan™ FC Microplate Photometer (Thermo Fisher Scientific, India) and then compared to those of Biotin and RGD tripeptide. After the dissolution of the samples in deionized water, the solutions were transferred in a 96-well and scanned using wavelengths ranging from 200 to 800 nm. The graph of absorbance against the wavelength was then plotted and the difference in optical absorbance was determined.

## 2.3. In-Silico Characterization

### 2.3.1. Frontier Molecular Orbital Analysis

Quantum mechanical descriptors such as highest occupied molecular orbital (HOMO) and lowest unoccupied molecular orbital (LUMO) are used to validate experimental data and to predict the chemical reactivity of the complex. The calculated HOMO-LUMO energy gap is the conventional measure of kinetic stability of the molecule and is calculated using Becke, 3-parameter, Lee-Yang-Parr (B3LYP) correlation function of DFT with 6-31G\*\* basis set. Other quantum mechanical descriptors were calculated using the BIOVIA Discovery studio Visualizer (v2019). The output data, such as the optimized geometry, density, potential and HOMO-LUMO were visualized.

### 2.3.2. Molecular Docking Analysis

The 3D structures of Di-Biotin-RGD and RGD tripeptides were designed and imported from AC/D ChemsSketch. The ligands were optimized using ligprep in Schrodinger Maestro 11.8. and their tautomers were computed using the specific OPLS3e force field energy. The crystal structure of ITGB1 with resolution 1.85 Å was imported from the Protein Data Bank (PDB ID: 4WJK). The docking analysis was performed in Maestro (Schrodinger LLC, 2018) with default settings. Following a series of ligand-receptor complexes with all the water molecules removed, hydrogen atoms were added to the 3D-coordinates and the H-bond assignment was optimized. Then the lowest binding energy which conforms to the best structure of the docked complexes was selected.

## 2.4. Binding affinity

The binding affinity of Di-Biotin-RGD on MDA-MB-231 cells was analyzed as previously described (Coussens et al., 2018).  $2 \times 10^4$  cells of one-cell suspension in DMEM with 10% (v/v) FBS were plated overnight in 96-well plate. Next day, the media was removed and the cells were washed with PBS, fixed with 4% formalin, blocked with 5% BSA and treated overnight at 4°C with increasing concentration (0 - 100  $\mu\text{M}$ ) of Di-Biotin-RGD and d-biotin solutions in Dulbecco's Phosphate Buffered Saline (130 mM NaCl, 0.03 mM KCl, 7.5 mM  $\text{KH}_2\text{PO}_4$ , 1.5 mM  $\text{Na}_2\text{HPO}_4$ , 1 mM  $\text{CaCl}_2$ , 0.5 mM  $\text{Mg}_2\text{SO}_4$ , pH 7.4). The cells were washed with PBS, stained with Streptavidin-HRP (1:500 v/v in deionized water) for 1 hour and incubated with TMB solution (1 mg/ml in DMSO mixed with 9 ml phosphate-citrate buffer at pH 5.0 and 2  $\mu\text{l}$  of fresh 30% hydrogen peroxide) for 30 minutes. The enzyme activity was stopped by the addition of the stop solution of 0.16 M sulfuric acid and the optical densities were read at 450 nm using a multiplate reader (Multiskan Go, Thermo Fisher Scientific, USA).

## 2.5. Diagnostic Potentials of Di-Biotin-RGD

### 2.5.1. Cytological Staining

The staining of receptors responsible for the interaction of Di-Biotin-RGD and MDA-MB-231 was carried as previously reported (Coussens et al., 2018).  $2 \times 10^4$  cells of one-cell suspension in DMEM with 10% (v/v) FBS were incubated overnight at 37°C in a 6-well plate. The media was removed, the cells were washed with PBS, fixed 4% formalin, blocked with 5% BSA and 1  $\mu\text{M}$  Di-Biotin-RGD in DPBS was added and the placed incubated overnight at 4°C. After washing with PBS, the cells were incubated with Streptavidin-FITC for 1 hour, washed visualized using ECLIPSE Ti2u inverted fluorescent microscope (Nikon, Japan).

### 2.5.2. Histological Staining

The histological studies with patient samples were approved and cleared by KMCH hospitals, Coimbatore with human ethical clearance (Ref: EC/AP/884/02/2022).



### 2.5.2.1. Hematoxylin Staining

Hematoxylin staining of cancer biopsies was performed using formalin-fixed paraffin-embedded blocks obtained from KMCH Hospitals, Coimbatore, India. The biopsy blocks were cut using a microtome into 4-micron thick sections using a rotary microtome MT1090a (Weswox Optik, India), and applied onto micro slides. The fixed sections were deparaffinized in three changes of xylenes and the sections were rehydrated in three changes of xylene and three changes of ethanol (100%, 90% and 75%) for 15 minutes each change. The hydrated sections were washed with deionized H<sub>2</sub>O then, 300 µl of hematoxylin solution was added in a humidified chamber and the slides were rinsed with tap water and dehydrated in three changes of ethanol (75%, 90% and 100%) and three changes of xylene for 2 minute each change. The slides were air dried then one drop of DPX mountant was placed immediately on top of the section and it was covered using a coverslip. The covered slides were observed using Lx 300 Labomed microscope (Lablink Instruments, India) attached with Ultrascope 9.1v (Arche Biologics, India)

### 2.5.2.2. Peroxidase Staining

Peroxidase staining of formalin-fixed paraffin-embedded cancer biopsies was performed on 4-micron thick sections obtained with rotary microtome MT1090a (Weswox Optik, India). The fixed sections were deparaffinized using xylenes and the sections were rehydrated in ethanol (100%, 90% and 75%). The hydrated sections were washed with deionized H<sub>2</sub>O. The non-specific binding sites were blocked with 3% BSA in PBS before the addition of 10 µM of d-biotin and Di-Biotin-RGD followed by overnight incubation at 4°C. The slides were treated with streptavidin-HRP then washed with PBS and incubated in TMB solution. After sufficient color formation occurred, the stop solution was added, the sections were then washed with deionized H<sub>2</sub>O. After drying of the slides, one drop of DPX mountant was placed and immediately the coverslip was placed on top of the slide. The slides were imaged using Lx 300 Labomed microscope (Lablink Instruments, India) attached with Ultrascope 9.1v (Arche Biologics, India)

## 2.6. Therapeutic Potentials of Di-Biotin-RGD

### 2.6.1. Cytotoxicity Assay

The cytological effect of Di-Biotin-RGD on MDA-MB-231 was carried out by the method described by **Yang et al., 2006**.  $2 \times 10^4$  cells of one-cell suspension in DMEM with 10% (v/v) FBS were incubated overnight at 37°C in a 96-well plate. The media was removed, the cells were then incubated for 24 hours at 37°C with increasing concentration (0 – 100 µM) of RGD tripeptide and Di-Biotin-RGD in serum-free DMEM. The images were taken with inverted microscope (ECLIPSE Ti2u, Nikon, Japan) at 10x magnification. The media was removed and the cells were incubated with 100 µl MTT solution (0.25mg/ml) for 4 hours. The formazan crystals were solubilized with 100 µl DMSO and the optical densities were obtained at 590 nm using a multiplate reader (Multiskan Go, Thermo Fisher Scientific, USA). The cytotoxic effects of RGD tripeptide and Di-Biotin-RGD were calculated according to the following equation:

$$\text{Cell death \%} = \frac{\text{OD control} - \text{OD sample}}{\text{OD control}} \times 100$$

Where, **OD control** and **OD sample** represented the absorbance values of the untreated and treated cells respectively.

### 2.6.2. Apoptosis Assay

The apoptotic effect of Di-Biotin-RGD on MDA-MB-231 was carried as previously reported (**Buckley et al., 1999**).  $2 \times 10^4$  cells of one-cell suspension in DMEM with 10% (v/v) FBS were incubated overnight at 37°C in a 96-well plate. The media was removed, the cells were incubated for 24 hours at 37°C with 30 µM of d-biotin, RGD tripeptide and Di-Biotin-RGD in serum-free DMEM. The media was removed and the cells were trypsinized, centrifuged and the pellet was mixed with Annexin V & Dead Cell Reagent and incubated in the dark for 20 minutes. The early, late apoptotic and dead cells percentage was determined by Muse Cell Analyzer (Millipore, Billerica, MA, USA).

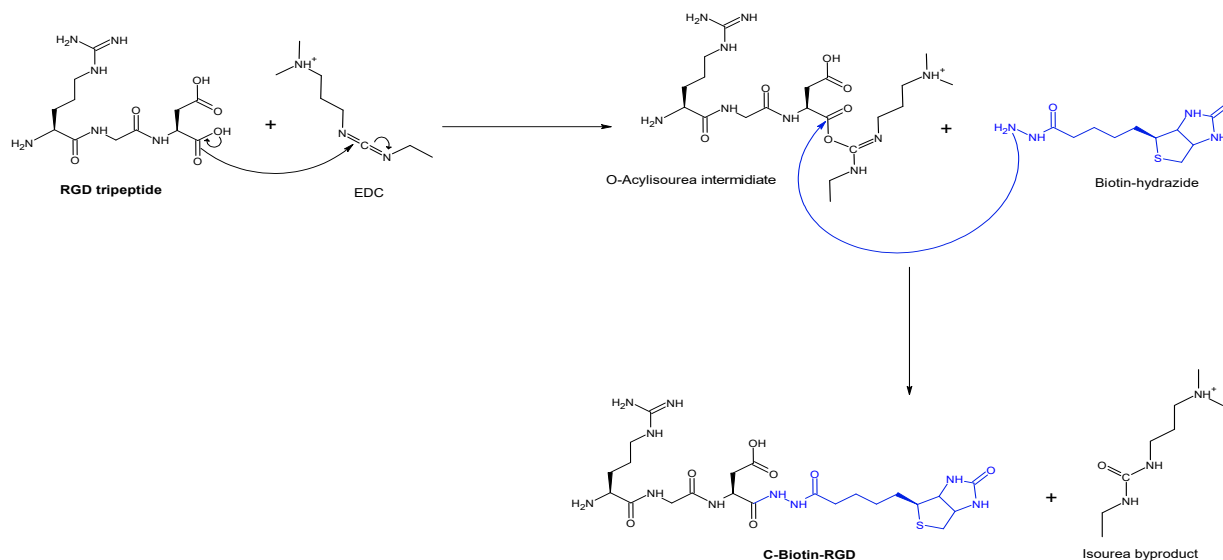
## 2.7. Statistical Analysis

All the values are expressed as mean  $\pm$  S.D. The results were computed statistically by one-way analysis of variance (ANOVA) followed by a Dunnett's test (using Graphpad InStat version 3.00 for windows XP; GraphPad Software, Inc., La Jolla, CA). A p-value  $\leq$  0.05 was considered significant.

## 3. RESULTS

### 3.1. Synthesis of Di-Biotin-RGD

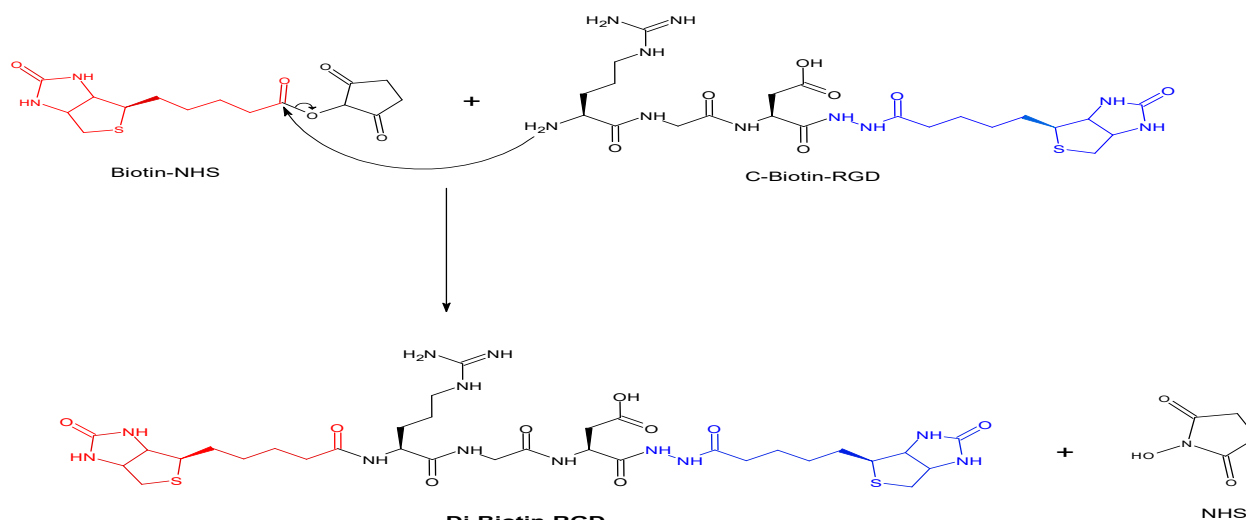
The synthesis of C-biotinylated RGD was done first by a nucleophilic attack between primary carboxylic group of aspartic acid residue of RGD tripeptide and EDC resulted in the formation of an unstable O-acylisourea intermediate. Second, a  $S_N2$  reaction between the activated carboxyl group of the unstable intermediate and N-terminal amino group of biotin hydrazide which yielded C-Biotin-RGD and isourea as a byproduct (**Figure 1**). The buffer exchange and product separation were done in PBS through dialysis with a cellulose acetate membrane with a molecular weight cutoff of 500 Da.



**Figure 1.** The synthetic mechanism of C-Biotin-RGD.

EDC-mediated coupling between the primary carboxylic group of RGD tripeptide followed by a nucleophilic attack by biotin-hydrazide resulted in a hydrazine bridge between RGD tripeptide and biotin.

The synthesis of Di-biotinylated RGD was finished by tagging biotin to N-terminal end of C-biotinylated RGD with Biotin-NHS through a nucleophilic attach from RGD tripeptide to displace NHS resulting in the formation of amide bond between the amino group of C-biotinylated RGD and carboxyl group and the release of NHS as the byproduct (**Figure 2**).



**Figure 2.** The synthetic mechanism of Di-Biotin-RGD.

A nucleophilic attach from N-terminal amino group of C-biotinylated RGD towards the carbonyl group of biotin-NHS resulted in a displacement of NHS and the formation of Di-Biotin-RGD.

### 3.2. Characterization of Biotinylated RGD Derivatives

#### 3.2.1. Fourier Transformation Infrared Spectroscopy

FTIR spectra of d-biotin, Di-Biotin-RGD and RGD tripeptide were used to confirm the synthesis of Di-Biotin-RGD (**Figure 3**). Di-Biotin-RGD shared similar peaks with RGD tripeptide at  $1011.48\text{ cm}^{-1}$  which corresponded to the N-H deformation and C-N stretching vibration characteristic of the new amide II bond. The

imidazole band confirmed the presence of biotin at the absorbance peak of  $950.734\text{ cm}^{-1}$  and was shared between Di-Biotin-RGD and d-biotin (Ho et al., 2020; Balan et al., 2012).

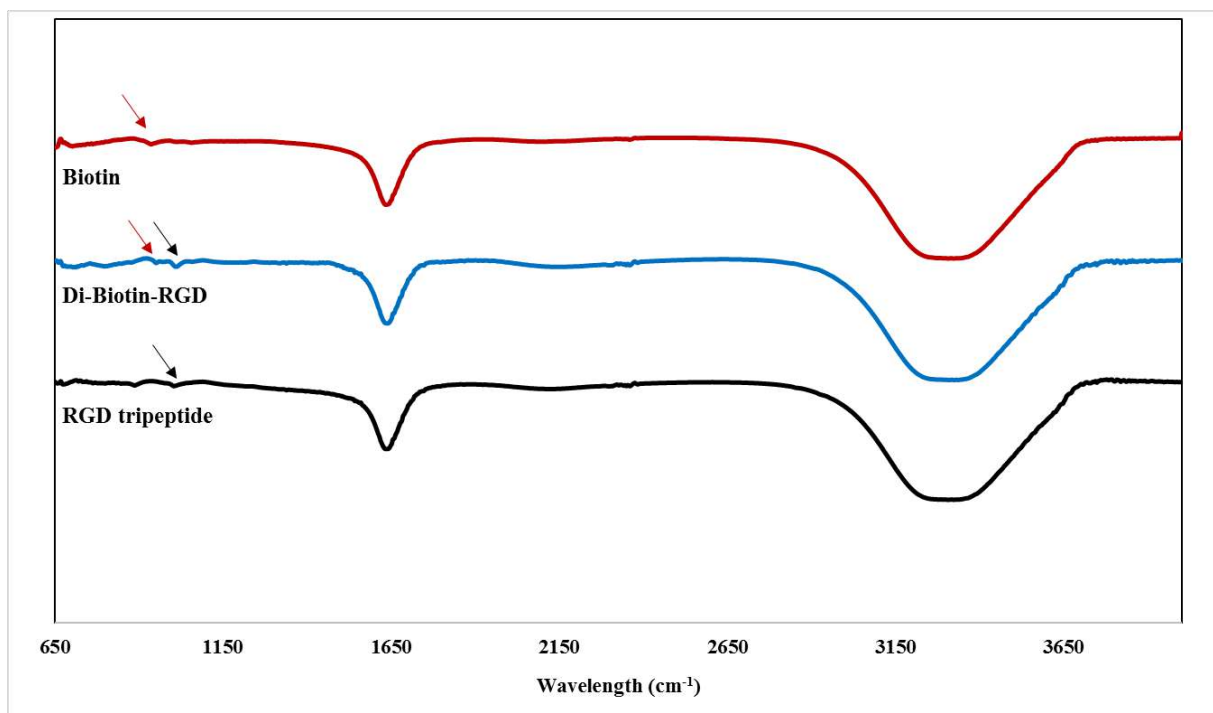


Figure 3. FT-IR spectra of d-biotin, Di-Biotin-RGD and RGD tripeptide.

### 3.2.3. UV-Visible Spectroscopy

UV-Visible spectral analysis of Di-Biotin-RGD showed that the addition of biotin tags on the terminal ends of RGD tripeptide resulted in increased absorbance between 270 and 320 nm. The absorbance of the derivative was more similar to that of d-biotin than that of RGD tripeptide (Figure 4).

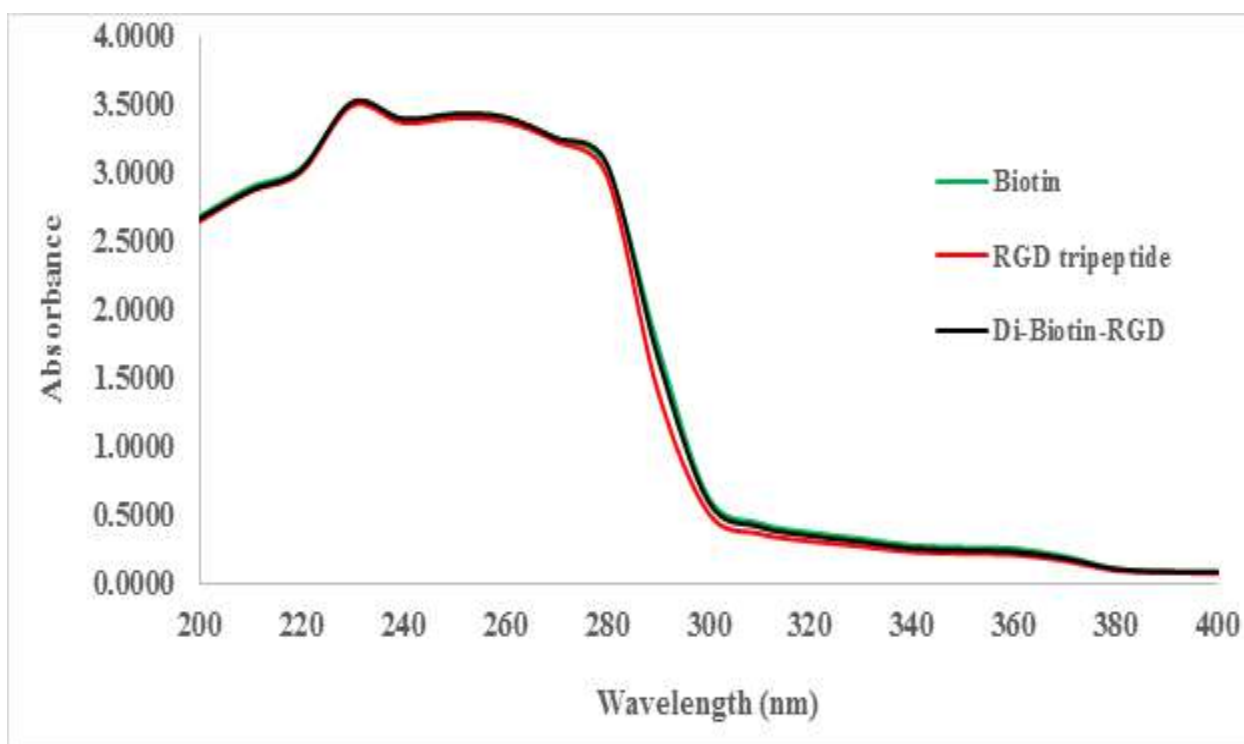


Figure 4. The UV-Visible spectrogram of biotinylated RGD derivatives.

### 3.2.4. Reverse-Phase High Performance Liquid Chromatography

The retention time for RGD tripeptide was 3.505 minutes while it was 2.728 minutes for Di-Biotin-RGD (Figure 5).

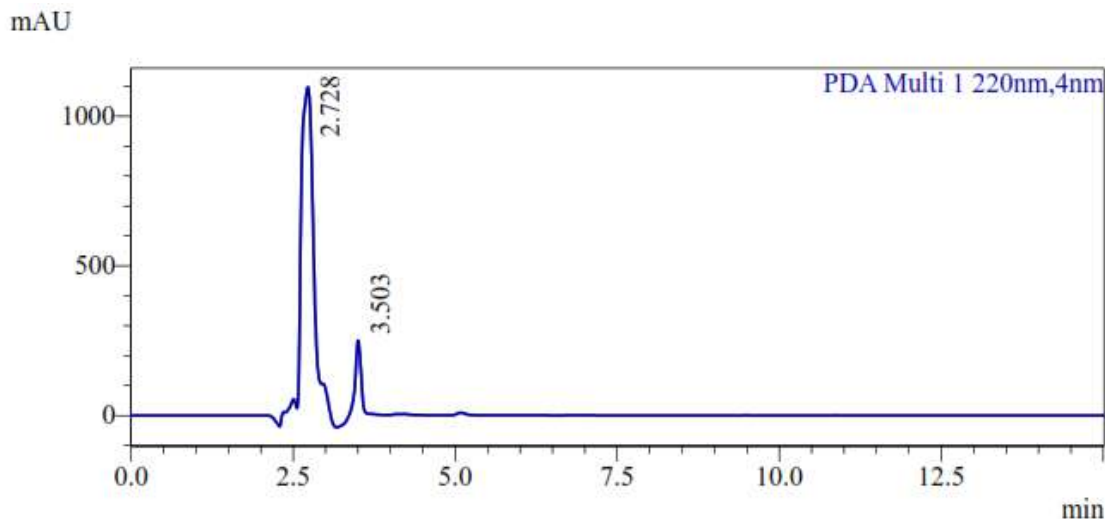


Figure 5. The RP-HPLC analysis of Di-Biotin-RGD

### 3.2.5. Frontier Molecular Orbital (FMO) Analysis

The large HOMO-LUMO gap related to high kinetic stability and low chemical reactivity and lower HOMO-LUMO gap is important for low chemical stability, because addition of electrons to a high-lying LUMO and/or removal of electrons from a low-lying HOMO is energetically favorable in any potential reaction (Tighadouini, 2018). Di-Biotin-RGD displayed lower binding energy of -16.1495 in comparison to RGD tripeptide which predicted a better interaction at the cellular level as substantiated in MDA cell lines (Figure 6 and Table 1).

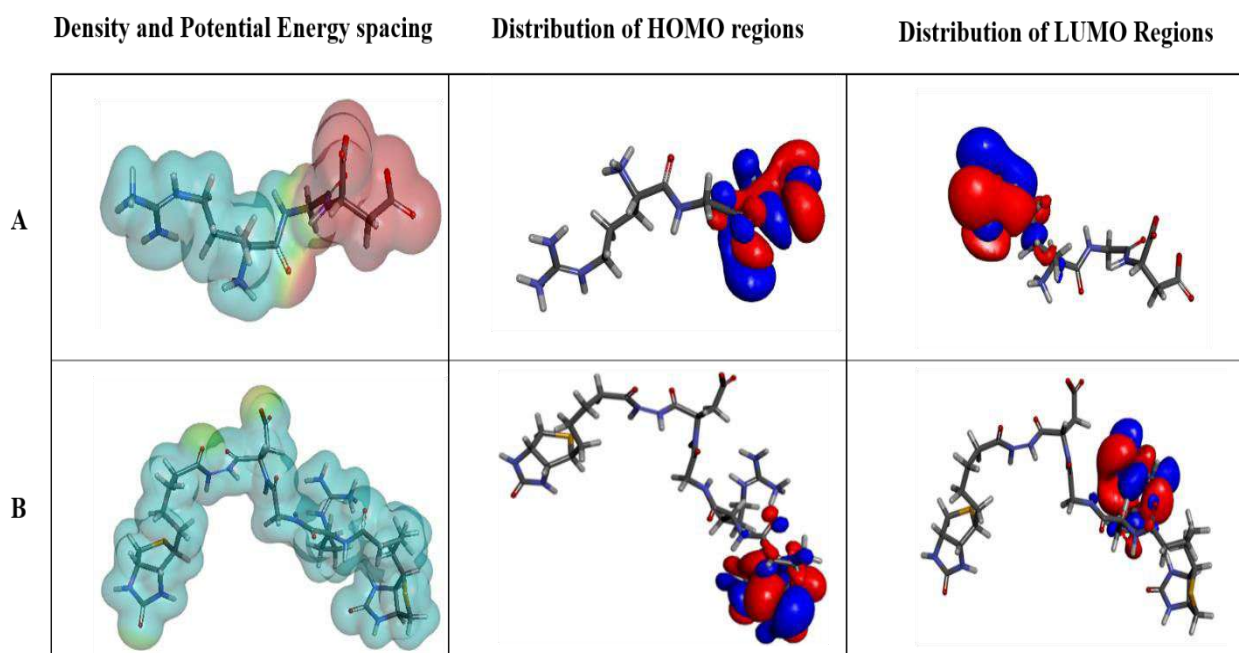


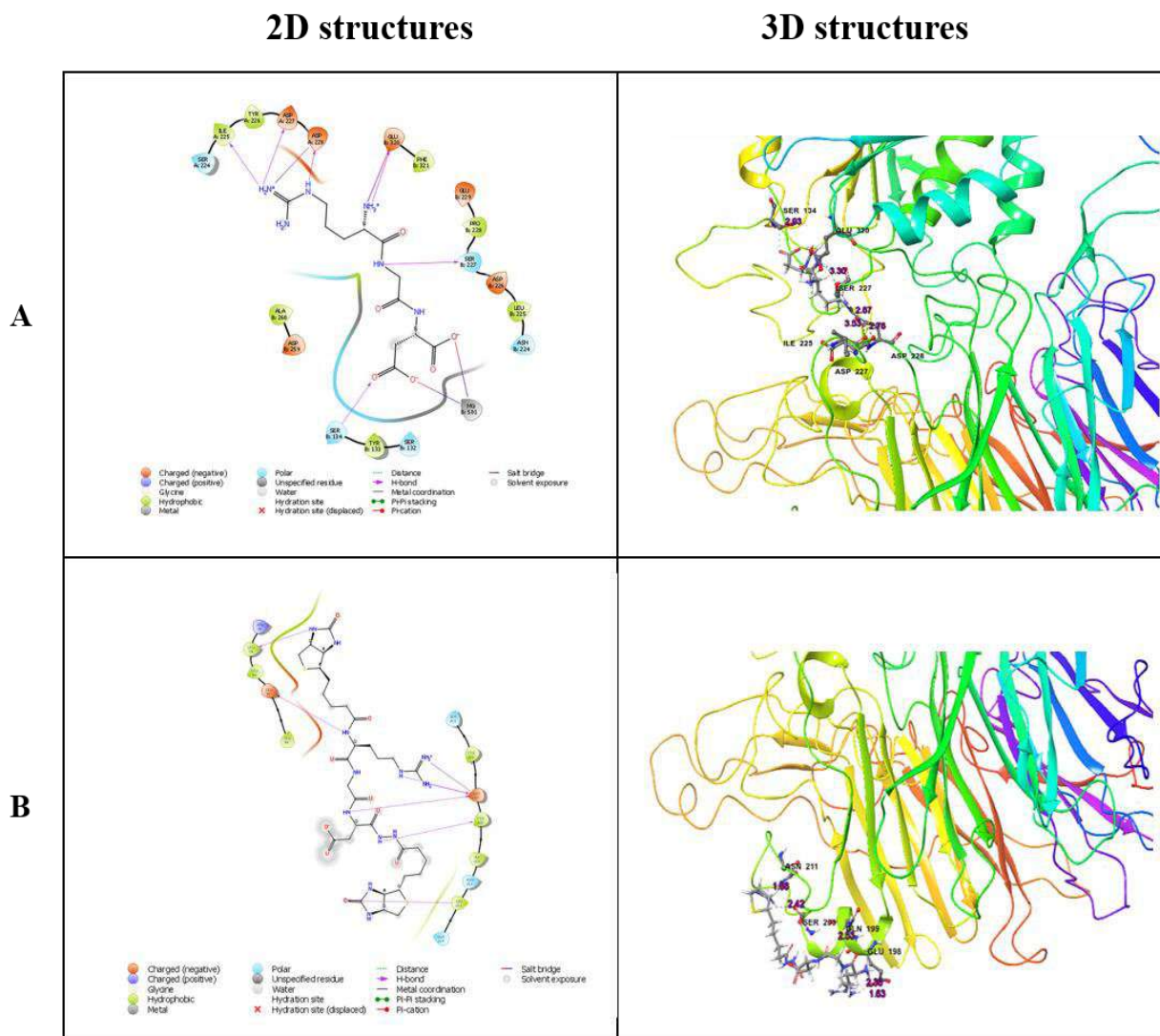
Figure 6. The FMO analysis: A. RGD tripeptide and B. Di-Biotin-RGD.

Table 1 - FMO Analysis

Compounds	Total energy (Ha)	Binding energy (Ha)	HOMO Energy	LUMO Energy	Band Gap energy ( $\Delta E$ )
RGD	-1250.53	-7.10236	-0.118165	-0.0371228	0.0810424
Di-Biotin - RGD	-3380.39	-16.1495	-0.224974	-0.135936	0.0890383

### 3.2.6. Docking Analysis of RGD and Its Biotinylated Derivatives against ITGB1

Docking structures, both 2D and 3D conformations, showed that the interaction between RGD tripeptide or Di-Biotin-RGD against ITGB1 had its unique conformational structure and that the receptor involved different amino acids and a different conformational structure while interacting with each ligand (Figure 7).



**Figure 7.** Molecular docking analysis against ITGB1: A. RGD tripeptide; B. Di-Biotin-RGD.

The bonds formed between each ligand and the receptor were also unique. Even though RGD tripeptide had higher number of bonds involved in interaction, DI-Biotin-RGD had higher docking and glide score. This may be due the involvement of both biotin rings in the interaction with ITGB1 (**Table 2**).

**Table 2.** Molecular docking analysis

### 3.3. Binding Affinity Assay

The increase in concentration of biotin and Di-Biotin-RGD resulted in increased interaction. The plotted graph

Ligand	Bonds involved	Involvement of amino acid Residues	involvement of Biotin ring	Involvement of ionizable Side Chains	Docking Score	Glide Score
<b>RGD</b>	10	SER B:227 GLU B:320 (2) MG B:501	-	SER B:134 ILE A:225 ASP A:227 ASP A:228 (2) MG B:501	-7.53	-7.66
<b>Di-Biotin-RGD</b>	8	GLU81 GLU207 TYR208	LEU79 LEU212	GLU207(3)	-7.276	-50.017

showed that Di-Biotin-RGD had higher binding interaction compare to d-biotin (**Figure 8**). The presence of an extra biotin tag as well as RGD motif may suggest that either on of them or both are involved in the binding affinity of Di-Biotin-RGD on the cancer cell surface receptors.

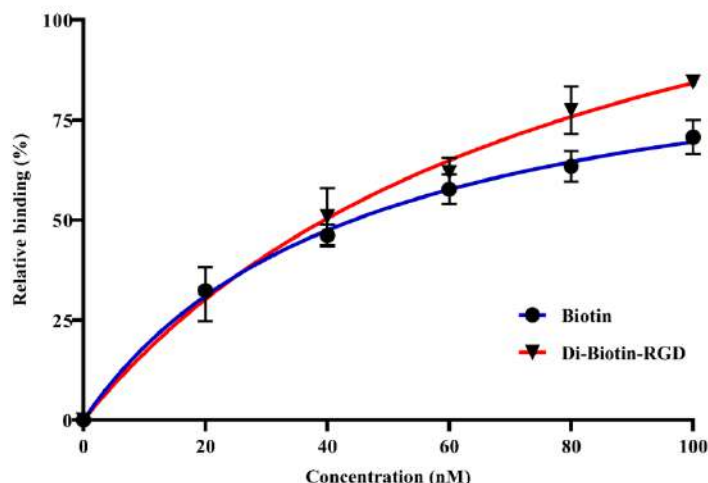


Figure 8. Comparison of binding affinity of Di-Biotin-RGD and d-biotin in DPBS

### 3.4. Diagnostic Potential of Di-Biotin-RGD

#### 3.4.1. Cytological Staining

The bond between biotin and streptavidin is one of the strongest non-covalent interaction known in the nature with a dissociation constant of biotin-streptavidin is around  $10^{-14}$  mol/L (Chalet and Wolf, 1964). This interaction is resistant to organic solvents, denaturants, detergents, proteolytic enzymes, and extremes of temperature and pH make it a perfect diagnostic tool for peptide analysis (Bayer et al, 1986). Fluorescein isothiocyanate (FITC) as a fluorophore with a maximum absorption 494 nm and a maximum emission at 518 nm can be excited using the blue color spectrum (450-495 nm) and would emit the green color spectrum (495-570 nm). This behavior of FITC allowed us to minimize the background noise caused by the interference of other color spectra observed in white light microscopy (Haugland, 1990). Fluorescent staining of MDA-MB-231 cells further confirmed the superiority in interaction of Di-Biotin-RGD against d-biotin. The fluorescent intensity was observed to be higher for Di-Biotin-RGD in comparison to d-biotin. The lack of fluorescent in control confirmed the fact that the interaction between biotin tags and streptavidin-FITC was responsible for the fluorescence (Figure 9).

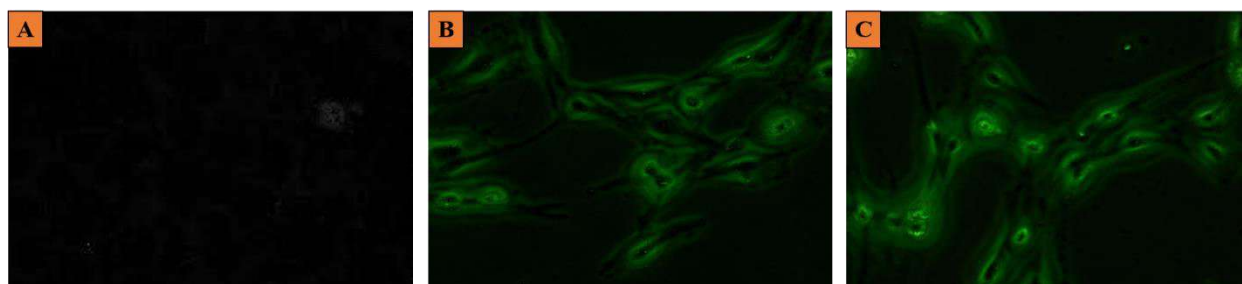


Figure 9. Cytological staining: A. Control; B. Biotin and C. Di-Biotin-RGD

#### 3.4.2. Histological Staining

The histological images showed the difference in the binding between hematoxylin, biotin and Di-Biotin-RGD. While for hematoxylin, the staining occurred with the nuclei, for biotin and Di-Biotin-RGD, the cell membrane was the mostly stained. Biotin had a weakly stain, whereas Di-Biotin-RGD staining was stronger and more intense with a perfect indication of the contours of the cell shape (Figure 10).

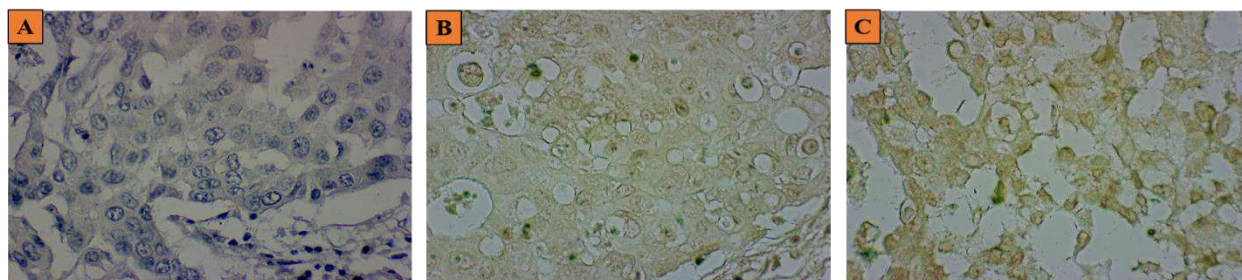


Figure 10. Cytological staining: A. Hematoxylin alone; B. Biotin and C. Di-Biotin-RGD

### 3.5. Therapeutic Effects of Di-Biotin-RGD

#### 3.5.1. Cytotoxicity Assay

The ability of Di-Biotin-RGD to inhibit the cell viability was tested by incubating MDA-MB-231 cells with increasing concentrations of Di-Biotin-RGD. Biotin and RGD tripeptide were used also to determine which part of the derivative is responsible for the interaction. After 24-hour incubation, the graph of cell death percentage against concentration was plotted and the  $IC_{50}$  value of  $28.3 \pm 4.21 \mu\text{M}$  was found for Di-Biotin-RGD. RGD tripeptide had a slight inhibition on the cell viability, even at  $100 \mu\text{M}$ , the cell death was below  $15.57 \pm 2.7439\%$  (Figure 11). To determine the structural changes caused by the presence of Di-Biotin-RGD, the images were taken after 24 hours incubation with  $30 \mu\text{M}$ . The cells incubated with Di-Biotin-RGD showed a change in shape, from well-spread cells to round cells and a reduction in size for some cells with RGD tripeptide representing some of these effects. Biotin as a vitamin has no inhibitory effect on cell viability (Figure 12). The blocking of N-terminal and C-terminal ends of RGD tripeptide by biotin tags resulted in Di-Biotin-RGD which cannot be digested by exopeptidases thus, their bioavailability increased during the treatment while the improved binding of Di-Biotin-RGD to RGD-recognizing integrins may explain the increased cytotoxic activities against MDA-MB-231 cells.

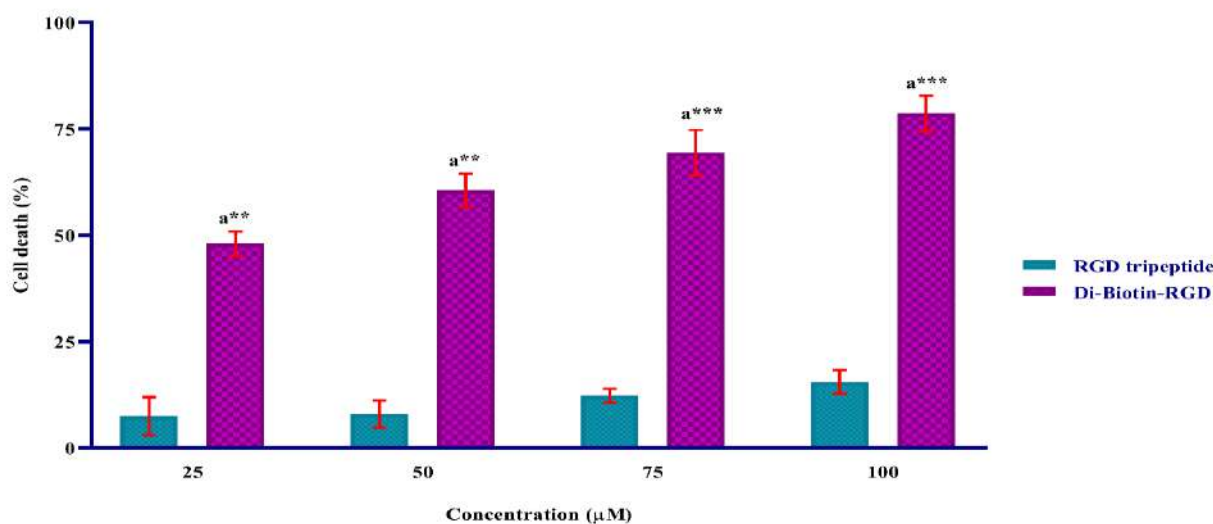


Figure 11. The percentage of dead cells after treatment of MDA-MB-231 cells with Di-Biotin-RGD:

Percentage of dead cells after 24-hour incubation with biotinylated RGD derivatives. The data represent the mean percentage  $\pm$  SD of total dead cells ( $n = 3$ ); a denoted RGD tripeptide vs Biotinylated RGD derivatives.  $p < 0.01$  was represented with \*\*,  $p < 0.001$  was represented with \*\*\*.

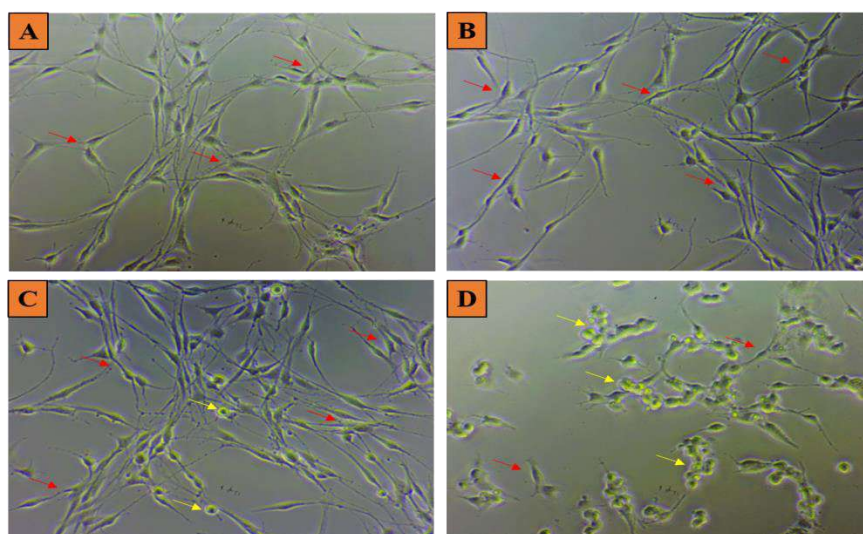


Figure 12. The cytotoxic effect of Di-Biotin-RGD against MDA-MB-231 cells. A. Control; B. Biotin; C. RGD tripeptide and D. Di-Biotin-RGD. The live cells are represented by red arrows while the dead cells were represented with yellow arrows.

### 3.5.2. Apoptosis Assay

Anoikis is a form of apoptosis caused by the lack of communication between the cell and its surrounding, in the form of the interaction between RGD-containing ligands and RGD-recognizing integrins, either due to the absence of endogenous ligands or the presence of a strong competitive inhibitor (Ulrich et al, 2003). To determine whether cell death was caused by the inhibitive strength of Di-Biotin-RGD thus preventing the interaction between RGD-containing ligands and RGD-recognizing integrins, apoptosis assay was carried out in this study. The results confirmed that Di-Biotin-RGD had higher apoptotic effect on MDA-MB-231 cells compare to RGD tripeptide (Figure 13). The increased stability of RGD motif due to the presence of biotin tags improved the interactive strength of RGD sequence towards RGD-recognizing integrins thus, preventing the interaction of RGD-containing ligands and RGD-recognizing integrins (Desgrosellier et al., 2010). Biotin lacked any inhibitory effect on cell viability and as a vitamin, it had a protective effect on the viability of cells. The cells treated with d-biotin were healthier than the cells in control (Figure 14). This may be due to the absence of serum during the treatment and the involvement of biotin in gluconeogenesis, lipogenesis, amino acid metabolism and energy transduction may explain the increased viability of cells treated with d-biotin (McMahon, 2002).

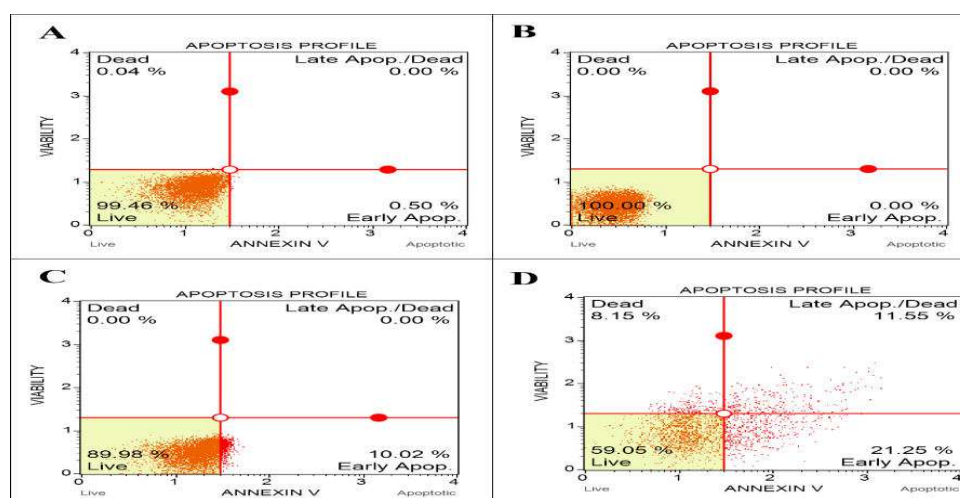


Figure 13. The apoptotic effect of biotinylated derivatives against MDA-MB-231 cells: A. Control; B. Biotin; C. RGD tripeptide; D. Di-Biotin-RGD.

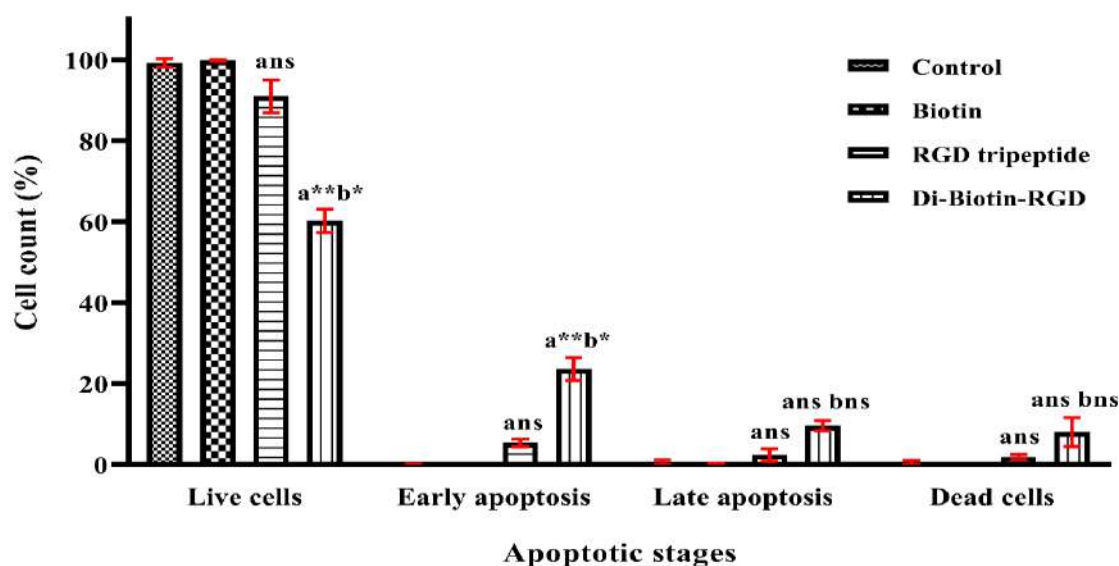


Figure 14. The apoptotic effect of biotinylated derivatives against MDA-MB-231 cells:

Percentage of cell count depending on the apoptotic stages after 24-hour incubation with biotinylated RGD derivatives. The data represent the mean percentage  $\pm$  SD of total dead cells (n = 3); a denoted Biotin vs RGD tripeptide or Di-Biotin-RGD while b denoted RGD tripeptide vs Di-Biotin-RGD. P > 0.05 was represented by ns, p < 0.05 was represented with \*, p < 0.01 was represented with \*\*.



#### 4. DISCUSSION

RGD derivatives can be classified based on their structures into linear and cyclic (Hirano et al., 1991; Kumagai et al., 1991). Cyclic RGD peptides showed an increased IC<sub>50</sub> value mainly due to rigidity formed by the cyclization process but most importantly this lack of flexibility made the resultant peptides more specific to certain integrins not others (Kapp et al., 2017).

The presence of RGD sequence in a polypeptide linear chain limit the overall specificity of RGD motif to all RGD-recognizing integrins. This is because the binding of RGD-containing ligands to their respective integrins requires a fourth amino acid to have a specificity of binding in form of RGD<sub>X</sub> with X as a flanking amino acid residue. The fourth amino acid is serine for fibronectin and fibrinogen; Valine for Vitronectin; Cysteine for pro-von Willebrand factor and Phenylalanine for fibrinogen (Tranqui et al., 1989). To increase the overall number of RGD-recognizing integrins that are able to interact with RGD sequence, in our study we chose RGD tripeptide as it is the common sequence that all integrins that recognize RGD motif use.

Linear amphiphilic RGD peptides have shown to be prone to exopeptidase digestion due to the presence of free N-terminal and C-terminal ends which makes them easy target for aminopeptidases or carboxypeptidase or both. To bypass this issue, various linear peptides were then tagged with Acetyl on N-terminal followed by alteration of carboxylic group at C-terminal into amide group, thus blocking the charged end of the peptide; Ac-RGDV-NH<sub>2</sub> and Ac-RGDC-NH<sub>2</sub> (Horton et al., 1993). But this resulted in a reduced IC<sub>50</sub> value even though their stability against exopeptidase increased. In our study, we confirmed both with in-silico studies but also with binding affinity and cytotoxicity assays that in comparison with RGD tripeptide, Di-Biotin-RGD had an increased interaction with RGD-recognizing integrins resulting in inhibition of biological activities that these integrins are known to preserve in cancer, including proliferative effects and resistance to apoptosis.

Exopeptidases are enzymes that removes the amino acid residues from the terminal ends of peptides by digesting the peptide bonds between the residue and the rest of the peptide. They are of two types, aminopeptidases and carboxypeptidases. Aminopeptidases removes the amino acid that represent the N-terminal end of peptide while carboxypeptidases digest the amino acid that represent the C-terminal end of the peptide. For RGD tripeptide, Aminopeptidase B (APB) and Carboxypeptidase O (CPO) are the exopeptidases responsible for digestion of arginine and aspartic acid residues for RGD tripeptide (Taylor et al., 1993; Langner and Anson, 2002). The blocking of both N-terminal and C-terminal ends of RGD tripeptide using biotin tags prevented the resulting derivative, Di-Biotin-RGD, to be digested by neither APB nor CPO, which increased the availability of RGD motif to inhibit the interaction between RGD-containing ligands and RGD-recognizing integrins.

Biotin as a vitamin has a proliferative effect on cancer cells, thus, to analyze the cytotoxicity effect of RGD motif, we chose biotin as it would not have antiproliferative effect on cells. This meant that any inhibitory activities observed after incubation with Di-Biotin-RGD is a result of the RGD sequence only. Another reason of choosing biotin tags as the conjugates is that biotinylated biomolecules can be performed using streptavidin conjugated to either a colorimetric enzyme or a fluorescent tag (Chalet and Wolf, 1964). This specific interaction was used to perform in-vitro as well as ex-vivo diagnostic tests. The interaction between Di-Biotin-RGD and surface receptors of MDA-MB-231 cells as well as those present in cells within formalin-fixed paraffin-embedded tissues confirmed the diagnostic potential of Di-Biotin-RGD against breast cancer. The fact that there is clear difference between the binding of d-biotin and that of Di-Biotin-RGD may suggest that Di-Biotin-RGD rely more on the RGD motif than biotin tag to interact with surface receptors.

Cell viability is one of the effect that the interaction between endogenous ECM ligands and integrins are involved in (Cindy et al., 2002). The competitive inhibition of this interaction by Di-Biotin-RGD would have an inhibitive effect on cell viability. This was confirmed with the IC<sub>50</sub> value of Di-Biotin-RGD of 28.3 ± 4.21 μM. RGD tripeptide had a slight inhibitory effect while d-biotin had the preserving effect of cell viability, as seen in apoptosis assay. Biotin as a vitamin showed no inhibitory effect on the cell viability while RGD tripeptide showed a very low inhibition of cell viability. This low effect on cell viability may be because of the low interaction between RGD tripeptide and RGD-recognizing integrins due to high flexibility in structural confirmation of RGD which results in the formation of weak bonds. But also, the increased expression of exopeptidases such as APB or CPO responsible for the digestion of amino acids present on N-terminal and C-terminal ends of RGD tripeptide may be responsible for this reduced interaction.

As a diagnostic prospect, Di-Biotin-RGD showed to interact with cancer cell surface receptors both in-vitro against MDA-MB-231 cells and ex-vivo against formalin-fixed paraffin-embedded breast cancer tissues. As a therapeutic prospect, Di-Biotin-RGD had a significant inhibitory effect against MDA-MB-231 cells in

comparison to both RGD tripeptide and d-biotin. In conclusion, it is evident that Di-Biotin-RGD as a novel molecule has both diagnostic potentials and therapeutic potentials against breast cancer and it may be a well-deserved candidate as a theragnostic tool for the clinical phase trials in the future.

## REFERENCE

1. Balan V, Petrache I, Popa IM, Butnaru M, Barbu E, Tsibouklis J et al. Biotinylated chitosan-based SPIONs with potential in blood-contacting applications. *Journal of Nanoparticle Research*. 2012;14. doi:10.1007/s11051-012-0730-y.
2. Buckley CD, Pilling D, Henriquez NV, Parsonage G, Threlfall K, Scheel-Toellner D et al. RGD peptides induce apoptosis by direct caspase-3 activation. *Nature*. 1999;397(6719):534-9. doi:10.1038/17409.
3. Chatterjee, J., Rechenmacher, F., Kessler, H. (2013). N-Methylation of peptides and proteins: An important element for modulating biological functions. *Angewandte Chemie*. 52, 254–269.
4. Cindy, K. M and Joan, S. B. (2002). Sensing the environment: a historical perspective on integrin signal transduction. *Nature Cell Biology* 4, 83-90.
5. Desgrosellier Jay S. & David A. Cheresh ;Integrins in cancer: biological implications and therapeutic opportunities; *Nature Reviews Cancer* volume 10, pages9–22(2010), January 2010
6. Desgrosellier, J. S., Cheresh, D. A. (2010). Integrins in cancer: biological implications and therapeutic opportunities. *Nature Review Cancer* 10(1), 9–22.
7. Frisch, S. M., & Ruoslahti, E. (1997). Integrins and anoikis. *Current opinion in cell biology*, 9(5), 701-706.
8. Gupta KS and Dhillon PK. A review of breast cancer awareness among women in India: Cancer literate or awareness deficit?; *European Journal of Cancer, Elsevier*, 2015 Sep.
9. Gurrath, M., Müller, G., Kessler, H., Aumailley, M., Timpl, R. (1992). Conformation/activity studies of rationally designed potent anti-adhesive RGD peptides. *European Journal of Biochemistry* 210, 911–921
10. Haubner, R., Weber, W. A., Beer, A. J., et al: (2005). Noninvasive visualization of the activated alpha v beta 3 integrin in cancer patients by positron emission tomography and [(18)F]galacto-RGD. *PLoS Medicine* 2, e70
11. Heckmann, D., Kessler, H. (2007). Design and chemical synthesis of integrin ligands. *Methods Enzymology* 426, 463–503
12. Hirano Y., Kando Y., Hayashi T., Goto K. and Nakajima A. (1991) Synthesis and cell attachment activity of bioactive oligopeptides: RGD, RGDS, RGDV and RGDT. *J. Biomed. Mater. Res.* 25: 1523 – 34
13. Ho SL, Garam C, Yue H, Kim H-K, Jung K-H, Park J et al. In vivo neutron capture therapy of cancer using ultrasmall gadolinium oxide nanoparticles with cancer-targeting ability. *RSC Advances*. 2020;10:865-74. doi:10.1039/C9RA08961F.
14. Hong, F. D and Clayman, G. L. (2000). Isolation of a peptide for targeted drug delivery into human head and neck solid tumors. *Cancer Research* 60, 6551-6556.
15. Horton MA, Dorey EL, Nesbitt SA, Samanen J, Ali FE, Stadel JM, Nichols A, Greig R, Helfrich MH. Modulation of vitronectin receptor-mediated osteoclast adhesion by Arg-Gly-Asp peptide analogs: a structure-function analysis. *J Bone Miner Res*. 1993 Feb;8(2):239-47. doi: 10.1002/jbmr.5650080215.
16. Kapp TG, Rechenmacher F, Neubauer S, Maltsev OV, Cavalcanti-Adam EA, Zarka R et al. A comprehensive evaluation of the activity and selectivity profile of ligands for RGD-binding integrins. *Sci. Rep.* 2017, 7, 39805.
17. Kapp, T.G., Rechenmacher, F., Neubauer, S., Maltsev, O.V., Cavalcanti-Adam, A.E., Zarka, R., Reuning, U., Notni, J., Wester, H.-J., Mas-Moruno, C., et al. (2017). A comprehensive evaluation of the activity and selectivity profile of ligands for RGD-binding integrins. *Scientific Reports* 7, 39805
18. Kumagai H, Tajima M, Ueno Y, Giga-Hama Y, Ohba M. Effect of cyclic RGD peptide on cell adhesion and tumor metastasis. *Biochem Biophys Res Commun*. 1991;177(1):74-82.
19. McMahon RJ. Biotin in metabolism and molecular biology. *Annu Rev Nutr*. 2002;22:221-39. doi: 10.1146/annurev.nutr.22.121101.112819.

20. Miller BT, Collins TJ, Rogers ME, Kurosky A. Peptide biotinylation with amine-reactive esters: differential side chain reactivity. *Peptides*. 1997;18(10):1585-95. doi:10.1016/s0196-9781(97)00225-8.
21. Nakajima N, Ikada Y. Mechanism of amide formation by carbodiimide for bioconjugation in aqueous media. *Bioconjugate chemistry*. 1995;6(1):123-30. doi:10.1021/bc00031a015.
22. Nelson, C. M., VanDuijn, M. M., Inman, J. L., Fletcher, D. A., & Bissell, M. J. (2006). Tissue geometry determines sites of mammary branching morphogenesis in organotypic cultures. *Science*, 314(5797), 298-300.
23. Nieberler, M., Reuning, U., Reichart, F., Notni, J., Wester, H.J., Schwaiger, M., Weinmuller, M., Rader, A., Steiger, K., Kessler, H. (2017). Exploring the role of RGD-recognizing integrins in cancer. *Cancers* 9, 116.
24. Niu, G., Chen, X. (2011). Why integrin as a primary target for imaging and therapy. *Theranostics* 1, 30-47.
25. Pierschbacher, M.D., Ruoslahti, E. (1984). Cell attachment activity of fibronectin can be duplicated by small synthetic fragments of the molecule. *Nature* 309, 30-33
26. Pignatelli, M., Cardillo, M. R., Hanby, A and Stamp, G. W. H. (1992). Integrins and their accessory adhesion molecules in mammary carcinomas: loss of polarization in poorly differentiated tumors. *Human Pathology* 23(10), 1159-1166.
27. R. L. Siegel, K. D Miller and A. Jemal, " Cancer statistics,2018,"CA: A Cancer Journal for Clinicians,vol. 68,n0. 1npp. 7-30,2018
28. Rebek J, Feitler D. Mechanism of the carbodiimide reaction. II. Peptide synthesis on the solid phase. *Journal of the American Chemical Society*. 1974;96(5):1606-7. doi:10.1021/ja00812a061.
29. Ren WX, Han J, Uhm S, Jang YJ, Kang C, Kim JH, Kim JS. Recent development of biotin conjugation in biological imaging, sensing, and target delivery. *Chem Commun (Camb)*. 2015 Jul 4;51(52):10403-18. doi: 10.1039/c5cc03075g.
30. Sadikovic, B., Al-Romaih, K., Squire, J. A., & Zielenska, M. (2008). Cause and consequences of genetic and epigenetic alterations in human cancer. *Current genomics*, 9(6), 394-408.
31. Schwartz, M. A and Assoian, R. K. (2001), Integrins and cell proliferation:regulation of cyclin-dependent kinases via cytoplasmic signaling pathways. *Journal of Cell Science* (114)14, 2553-2560.
32. Siegel RL, Miller KD, Jemal A. Cancer statistics, 2018. *CA Cancer J Clin*. 2018 Jan;68(1):7-30. doi: 10.3322/caac.21442.
33. Syed Jamal Safdar. G,Ahmed. E, Baying . L and Tianfu Wang :Breast Cancer Detection and Diagnosis Using Mammographic Data: Systematic Review, 2019: *Journal of Medical Internet Research*,
34. Taddei, Faraldo, M. M., Teuli`ere, J., Deugnier, M. A., Thiery, J. P. and Glukhova, M. A. (2003). Integrins in mammary gland development and differentiation of mammary epithelium. *Journal of Mammary Gland Biology and Neoplasia* 8(4), 383-394.
35. Tighadouini, S., Benabbes, R., Tillard, M., Eddike, D., Haboubi, K., Karrouchi, K., & Radi, S. (2018). Synthesis, crystal structure, DFT studies and biological activity of (Z)-3-(3-bromophenyl)-1-(1, 5-dimethyl-1H-pyrazol-3-yl)-3-hydroxyprop-2-en-1-one. *Chemistry Central Journal*, 12(1), 1-11.
36. Tranqui L, Andrieux A, Hudry-Clergeon G, Ryckewaert JJ, Soye S, Chapel A, Ginsberg MH, Plow EF, Marguerie G. Differential structural requirements for fibrinogen binding to platelets and to endothelial cells. *J Cell Biol*. 1989;108(6):2519-27.
37. Ulrich Hersel, Claudia Dahmen, Horst Kessler\*, RGD modified polymers: biomaterials for stimulated cell adhesion and beyond, RGD modified polymers: biomaterials for stimulated cell adhesion and beyond
38. Wanhua, Y., Li, M., Hui, W., Rui, C., Rui, W., Xiangyi, M. A., Gang, X. U., Jianfeng, Z., Shixuan, W., Yunping, L. U and Ding, M. A. (2006). Inhibition of proliferative and invasive capacities of breast cancer cells by arginine-glycine-aspartic acid peptide in vitro. *Oncology reports* 15, 113-117

39. Yang W, Meng L, Wang H, Chen R, Wang R, Ma X et al. Inhibition of proliferative and invasive capacities of breast cancer cells by arginine-glycine-aspartic acid peptide in vitro. *Oncology reports*. 2006;15(1):113-7.
40. Zitzmann, S., Ehemann, V and Schwab, M. (2002). Arginine-glycine-aspartic acid (RGD)-peptide binds to both tumor and tumor endothelial cells in vivo. *Cancer Research* 62, 5139-5143.

**Table file**

**Table 1:** Pka Values Of N- And C-Terminal Residues Of Rgd Tripeptide

Amino acid	pKa		
	(-COOH)	(-NH <sub>2</sub> )	R group
Arginine (R)	2.0	9.0	12.5
Aspartic acid (D)	2.0	9.0	3.9

**Table 2.** FMO Analysis of biotinylated RGD derivatives

Compounds	Total energy (Ha)	Binding energy (Ha)	HOMO Energy	LUMO Energy	Band Gap energy (ΔE)
RGD tripeptide	-1250.53	-7.10236	-0.11816	-0.03712	0.08104
C-Biotin-RGD	-2316.35	-11.7279	-0.21544	-0.11516	0.10027
N-Biotin-RGD	-2297.23	-11.7875	-0.02216	-0.00925	0.01291

**Table 3.** The docking analysis of RGD and its Biotinylated Derivatives against ITGB1

Ligand	Bonds involved	Involvement of amino acid Residues	involvement of Biotin ring	Involvement of ionizable Side Chains	Docking Score	Glide Score
RGD tripeptide	10	SER B:227 GLU B:320 (2) MG B:501	-	SER B:134 ILE A:225 ASP A:227 ASP A:228 (2) MG B:501	-7.53	-7.66
C-Biotin-RGD	6	GLN 199	SER203 ASN211	GLU198 (2) GLU202	-6.427	-45.498
N-Biotin-RGD	7	SER203 GLU207 TYR208 ASN211	SER203 ASN211	GLU207 (3)	-5.86	-39.601

**Table 4:** Comparative analysis of the biological effects of charged biotinylated RGD derivatives

Biological activities	Control	RGD tripeptide	N-Biotin-RGD	C-Biotin-RGD
Attachment	+	-	---	--
Adhesion	+	-	---	--
Spreading	+	-	---	--
Cytotoxicity	-	+	++	+++
Apoptosis	-	+	++	+++

The biological effects were symbolized with “+” for the positive effects and “-” for negative effects; “+ +” for more positive; “+ + +” for the most positive effects; “- -” for more negative and “- - -” for the most negative effects.

## A Comprehensive Study on Biomass Derived Carbon Dots

<sup>1</sup>Mohd Abdullah Sheikh, <sup>2</sup>Khan Abida and <sup>3</sup>R S Chandok

<sup>1</sup>Bhagwant University, Ajmer

<sup>2</sup>Degree College for Women Anantnag J&K

<sup>3</sup>Sri Guru Tegh Bahadur Khalsa College Jabalpur, India

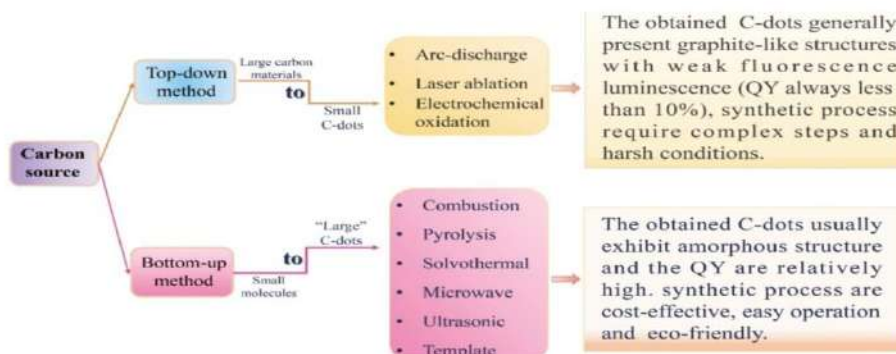
### ABSTRACT

I am writing this review paper on carbon dots, their basic structure, PL mechanism, new ways of synthesizing processes, factors influencing their characteristic properties, and how to use them in today's challenges; such as overcoming energy crises, monitoring pollution, biocompatible (in situ and ex situ) imaging, and drug delivery. There are two procedures for the production of carbon dots: top-down and bottom-up. The bottom-up approach includes: laser ablation, oxidation, and arc discharge methods, while the bottom-up approach includes: HTC, microwave-assisted and other methods. One must select a bottom-up approach for the uniform size control of carbon dots, which is a non-toxic preparation method that requires a lower cost of production. Nanostructured luminescent carbon dots created from biomass waste are a novel type of carbon-based microstructure with a number of benefits, including excellent photostability, cytocompatibility, and nontoxicity. In addition, the ease of surface functionalization provides them with a diverse spectrum of applications in biological imaging, energy storage, chemo-sensing, environmental control, diagnostic testing, and photocatalytic degradation, compared to semiconductor quantum dots and fluorescent biological groups. From an environmental point of view, biomass precursors can be used for the production of carbon dots because of their fair quantity, global availability, environmental benignity, and ability to degrade biological waste. They also contain a plethora of spontaneous components, such as lignin, cellulose, lignocellulose, carbohydrates, proteins, triglycerides, and naturally occurring minerals, such as iron, phosphorus, zinc, magnesium, and manganese, which are effective self-dopants and are mainly responsible for the improved quantum yield efficiency.

Keywords: Nano dots, Nano scale, Decomposition, De-hydrolysis, Carbonization, Bottom Up, Top Down, Super Sensitive, Tauc Method, Quantum Yield.

### INTRODUCTION

First, we must understand the origins of these nanocarbon dots as well as their immediate properties. We know that the physical and chemical characteristics of materials vary dramatically as their size; changes from bulk to nanoscale; therefore, the same phenomena occur in carbon dots, which are prepared through pyrolysis (decomposition, de-hydrolysis, and carbonization) of carbonaceous materials and exhibit photoluminescence and, photocatalytic properties. They were unintentionally discovered by Xu and others in mid-2004 [1], during the refinement of carbon NT'S and in 2006 [2], they got their name as "Carbon Dots" after Sun and his colleagues confirmed their synthesis route and associated structure. Carbon dots (C-dots) are a form of luminous carbon nanomaterials that are frequently explored in the carbon nanomaterial family. They are quasi-spherical particles with a particle size of less than 10 nm and provide a variety of benefits, including a high quantum yield and tunable emission wavelength. C-dots offer a variety of other desired qualities, including high photostability, low cytotoxicity, great biocompatibility, ease of (surface modification, and chemical inertness) and have drawn a lot of attention in recent years. Consequently, more work has been conducted to find new ways of preparation and to open new dimensions from an application point of view. C-dots are being used in a multitude of scenarios, including the fabrication of multicolored light-emitting diodes (LEDs), energy production and storage, live cell imaging, in-vivo studies, photocatalytic degradation, drug delivery, fluorescence sensing and so on [3–21], still Carbon dots are in its early phases of development. There are two synthetic approaches for fabricating nanomaterials top-down and bottom-up techniques, as shown in figure below.

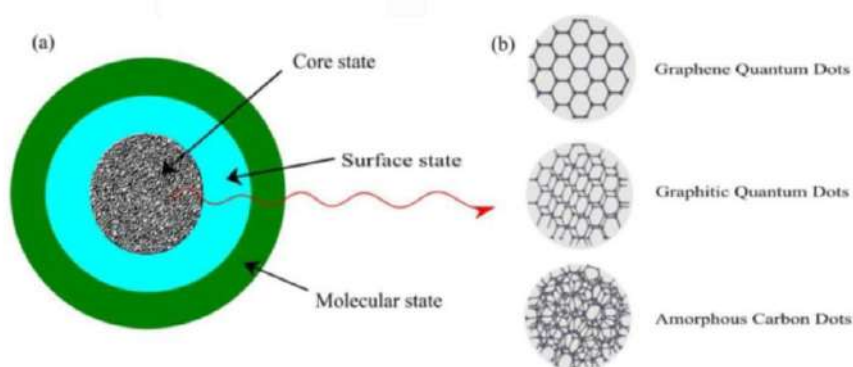


**Figure 1.** Top-Down technique and Bottom-Up way showing how to produce C-dots via different procedures (QY named as quantity of quantum yield) [22-40].

As the Top-Down technique, includes laser ablation, arc discharge and electrochemical release [22–28], it uses the procedure of breaking significantly larger carbon composites (for example, graphite, large graphene, synthetic carbon nanofibers and activated commercial charcoal) into small nanometric C-dots. According to the literature, difficult operational processes such as acid solutions, electrical discharges, expensive equipment and time-consuming steps are commonly employed in the synthesis of C-dots by top-down approaches limiting their usefulness. Bottom-up methods such as pyrolysis, hydrothermal techniques, convection methods, solvothermal methods and ultrasonic methods [29–40] go through hydrolysis, carbonization and passivation to transform tiny molecules into fluorescent C-dots. They have been frequently used in the production of C-Dots because of their minimal equipment requirements, ease of operation and cost-effectiveness; to be accurate we have two types of carbonaceous raw materials that might be utilized for the production of C-Dots [41]: biological and chemical carbon sources and for higher quantum yield efficiency [42] pure carbon dots must be passivated with heteroatoms on the edge surfaces. As biological sources naturally contain heteroatoms, therefore C-dots are now extensively produced from organic carbon composites such as natural organic products, organic chemicals and biological wastes [43, 44, and 45].

### Structural Morphology Of Carbon Dots

The structural characteristics of CDs are influenced by the source precursor material as well as the preparation techniques [46–49], however CD's can be separated into three zones based on photoluminescence emission, as shown in Figure 2a.



**Figure 2:** (a) Carbon dot structure and (b) carbon dot structural core analysis.

Starting with the innermost part, the CD core, which is made up of graphene-like sp<sup>2</sup>-bonded carbon atoms [50], as illustrated in Figure 2-b, has further classified the CDs into graphene quantum dots, graphite CDs, and heterogeneous CDs owing to their variations in the core sp<sup>2</sup> configuration. Graphitic carbon dots are composed of multiple layers of sp<sup>2</sup> hybridized carbon packed together; however, graphene quantum dots are two-dimensional materials consisting of a single layer of carbon atoms that share sp<sup>2</sup> hybridization binding. Apart from homogeneous graphitic nuclei, only a few papers have reported sufficiently high levels of N-doped structures and carbon nitride doped nanostructures as their core in graphitic or crystalline layouts [49]. The amorphous carbon dot is one of the most pervasive types of carbon dot structure and indeed the objective of this very study as the central core is composed of variable amounts of carbon to carbon graphene type sp<sup>2</sup>

hybridization, distributed in a gem type sp<sup>3</sup> conjugated carbon framework resulting in structural chaos [46-49], having semi-spherical structure with a diameter up to 10 nm, vertical dimensions of less than 5 nm are widely recognized [51] and the lattice spacing is typically 0.34 nm [51,52]. The surface state and the molecular state are two sub-sections of the CD framework that are positioned away from the centre, and the surface state of the sp<sup>2</sup> hybridized CD's core is mainly composed of heteroatomic binding sites of the following types: hydroxylic, carboxylic, amino, and amine groups. The molecular state is made up of individual chromophores that operate like organic dyes. These molecules are merely residual moieties that are coupled well to the CD outer edge, mostly during the occurrence of carbonization and dehydration reactions of the antecedent [53]” may be significantly improved and finally alkyl groups (polar) on carbon dots provide them with water solubility and dissolution rate and allow them to be functionalized with natural chemical, elemental and polymeric molecules [46,51,52]. In general, synthesis route comprises oxidation steps that spontaneously impart oxygen-containing entities to the CD edge, such as carboxylic, phenyl and OH groups [55]. In addition to that the CDs need to be passivated with more complicated compounds like hydrophilic polymers or polyethylenimine for very strong photoluminescence [49].

### Photoluminescence Mechanism (PI)

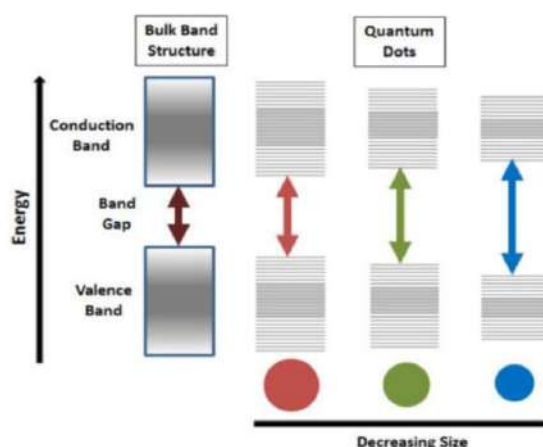
Several mechanisms have been proposed over the years to understand the PL character of CDs, just like quantum confinement effect, surface states or defects, molecular effects and interlinked molecular effects, but no consensus has been reached till now [46-56]. The following section gives a basic overview of the most widely understood concepts.

#### (a) Phenomena of Quantum Confinement

We know that if a structure's physical dimensions are close to that of a typical electron orbit, the whole system is quantum-confined; this phenomenon is known as quantum confinement [57]. When the system is in quantum confinement; the electronic and optoelectronic characteristics of the structure differ from those of the base material [57], which means that if the measurement of the specimen is larger than the wavelength of the particle, the particle may be regarded as free; and the quantum theory predicts that it would have a line spectrum but not a continuous spectrum, as we know that the particle's spectrum will just become sharper and increase the band gap of the carbon dots[57,58] when shifting, from the bulk to the nanometer scale. The following equation predicts the energy of a particle in a three-dimensional box model and can be used to explain the above statement:-

$$E(N_x, N_y, N_z) = (\hbar^2 \pi^2 / 2m) * [(N_x/L_x)^2 + (N_y/L_y)^2 + (N_z/L_z)^2] \quad \dots 1$$

It can be clearly observed from equation (1) that reduction in material dimensions correlates with an increase in energy. The blue shift in optical response owing to an increase in energy as the material transits from bulk to quantum structure as seen in Figure (2.1).



**Figure 2.1:** As the dimension gets smaller, the band gap increases. The blue shift in optical characteristics is caused by the bigger energy difference.

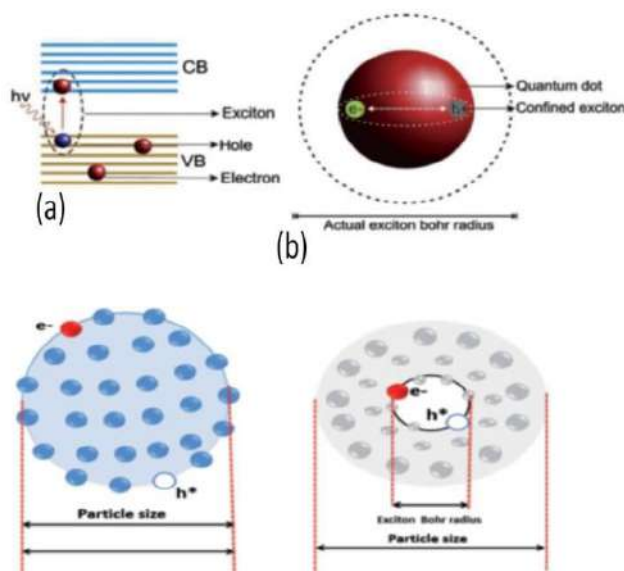
There are many other confinements; the layered structure includes restrictions on a single axis and is referred to as a quantum well or 1-D confinement structure, nanowires with 2-D constriction, and quantum dots with perfect 3-D restriction. When one or more dimensions of a nanocrystal are reduced to the size of an exciton, (commonly known as the Bohr exciton radius), a quantum-confinement effect occurs. As we already know [57,58,59], a quantum well is a two-dimensional structure with an average height of

approximately the Bohr exciton radius [57,58,59], despite the fact that the length and breadth might be rather large, whereas a quantum wire is a one-dimensional framework with a limited height and width but a considerable length, and a quantum dot is a zero-dimensional layout with all dimensions closer to the Bohr exciton radius, all showing a quantum confinement effect. Thus, quantum confinement has a unique effect on the nanostructure, and increasing number of confined charge carriers are generated, resulting in a wider gap between the separate energy states and an upper zero threshold energy. For example, charged particles constrained to a ball with diameter  $d$  have a larger zero-point energy than those restricted to a cube with a side length equivalent to  $d$ . This is due to the fact that such a sphere has a lesser volume ( $\pi/6d^3$ ) than a cube ( $d^3$ ) [57,58,59,60].

The exciton Bohr radius is:  $a_B^* = \epsilon_r (m_e/m) a_B$ .

Where  $a_B = 0.53$  Angstrom is the Bohr radius,  $\epsilon_r$  is the relative permittivity,  $m_e$  is the electron mass, and  $m = (m_e^* * m_h^*) / (m_e^* + m_h^*)$  is the electron-hole system's effective reduced mass. The effective mass of the electron and a hole are  $m_e^*$  and  $m_h^*$  respectively.

In an insulator (or semiconductor), an exciton is a virtual interaction of an electron and a mythological particle known as a void, produces electron-hole pair or a Physically interrelated electron-hole pair as depicted in (fig 2.2).



**Figure 2.2:** (a) Exciton formation (b) Resemblance of exciton diameter to QD size

This state is known as elementary excitation [57,58], a photonic particle excites one electron in an atom into the conduction band every time it interacts with semiconductor material, these excited electrons in the valence band leaves a space behind of opposite electric charge with which it is bounded via electrostatic force and thus exciton is formed, but has somewhat less energy than the unpaired electron and hole and it has a hydrogenic wave function (the "exotic atom" state is closer to that of a hydrogenic atom) because of the effective masses of the components and screening effects of the nucleus as the respective system size is substantially greater but the binding energy is much lower than a hydrogen atom [57,58,59]. At low temperatures (energies less than the exciton energy bands), the formation of exciton is the primary source of luminescence in semiconductors overtaking free electron-hole mixing at higher temperatures. Excitons can be treated in two ways, depending on the electromagnetic nature of the material, which means in a very low conductivity material the electrostatic Coulomb bonding between electron and hole pairs becomes very intense, resulting in a size deformation of the exciton nearly equivalent to the single crystal; hence, the electron and hole sit within the same basic cell called as the Frenkel exciton, which was named by J. Frenkel [59,60]. In another case when the permittivity is high enough just as in semiconductors, the electrostatic coupling between electron and hole pairs is reduced by the screening impact resulting in the Mott-Wannier exciton with a diameter much bigger than the lattice cell parameter; hence, a direct consequence of the lattice potential can be included in the beneficial effective masses of the electron/hole bound state, with an energy gap usually lower than that of a hydrogenic atom of the order of 0.1 eV.



### Electron - Hole Confinement

$E_g$  is the minimal energy necessary for an electron-hole pair in a nanoparticle and it is composed of numerous contributions, such as the bulk material band gap energy  $E_g$  and confinement energy [60, 61] for an electron-hole pair in a spherical quantum dot of diameter 'd'.

The total confinement energy is calculated as follows:

$$E_{con} = \pi^2 \hbar^2 / 2\mu d^2$$

Where  $\mu$  is excitons reduced mass & given as

$$\mu = (m_e^* \cdot m_h^*) / (m_e^* + m_h^*). \quad m_e^* = \text{effective Electrons mass. } m_h^* = \text{effective hole mass.}$$

Coulomb interaction is another effective term for this mutual interaction of the electron - hole pairs.

The Coulomb interaction is taken into consideration via  $E_{coul}$  as follows.

$$E_{coul} = -1.8 \cdot e^2 / 2\pi\epsilon\epsilon_0 d.$$

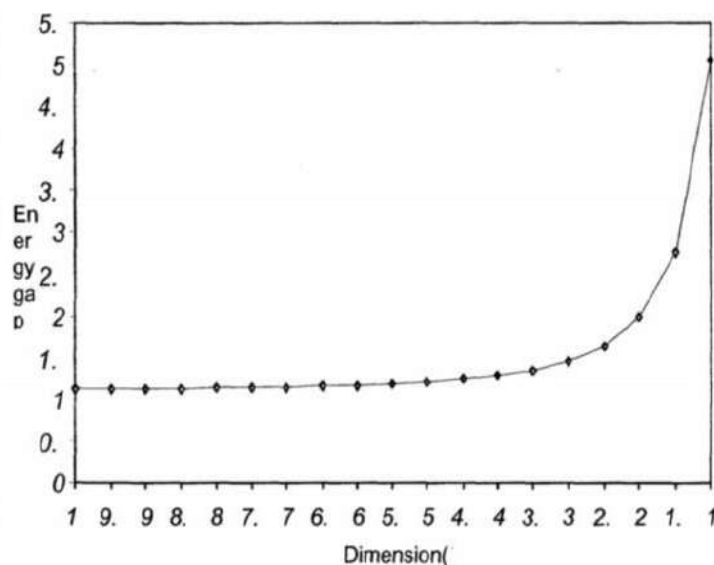
$\epsilon$  = Dielectric constant of the semiconductor CD.

The Brus equation, which describes the size-dependent energy gap of a spherical semiconductor quantum structure is represented as under;

$$E_g(\text{dot}) = E_g(\text{bulk}) + E_{con} + E_{coul}.$$

$$\Rightarrow E_g(\text{dot}) = E_g(\text{bulk}) + \pi^2 \hbar^2 / 2\mu d^2 - 1.8e^2 / 2\pi\epsilon\epsilon_0 d.$$

Using this Eq. for silicon semiconductor band gap variation is calculated and the calculated values are plotted against the dimension of cluster in below figure (2.3).



**Figure (2.3) ;** Silicon Energy band gap variation with Dimension. For Silicon bulk band gap  $E_g = 1.12$  eV,  $\epsilon = 1.19$ , electrons effective mass  $m_e^* = 1.18m_0$ , effective mass of hole  $m_h^* = 0.49m_0$ ,  $m_0$  electrons rest mass.

To check whether we are in the quantum confinement regime or not, we must have compared the radius of the material (R) with the Bohr exciton radius  $\alpha^*_B$  [61], which we define as small, moderate and strong confinement.

### The Weak (Mild) Confinement Concept

To see this realm the dimensions (R) of a nano crystallite structure ought to be higher than the bulk exciton Bohr radius ( $\alpha^*_B$ ) and the larger energy term of weak confinement is the electrostatic term, which is already present in size quantification of the exciton's movement. The confinement effect moves the excitons overall energy levels to higher energies and thus pushes energy,  $\Delta E$  proportionate to  $1/R^2$  [60,61]. The exciton ground state's energy " $\Delta E$ " shift is approximately given by;

$$\Delta E \approx \hbar^2 \pi^2 / 2MR^2.$$

Where  $M$  is the excitons effective mass and is written as  $M = m_e^* + m_h^*$ , whereas the effective masses of the electron and hole are  $m_e^*$  and  $m_h^*$  respectively.

### The Moderate Confinement Concept

In another aspect of quantum confinement, particularly in the II–VI semiconductor group, the Bohr radius ( $\alpha^*B$ ) is equal to the nanocrystallite structure diameter ( $R$ ) is a necessary condition for the moderate confinement rule and the following terms must be satisfied for the moderate confinement regime process [61,62]. In this regime well-restricted motion of a photo-excited hole were observed in tiny QDs.

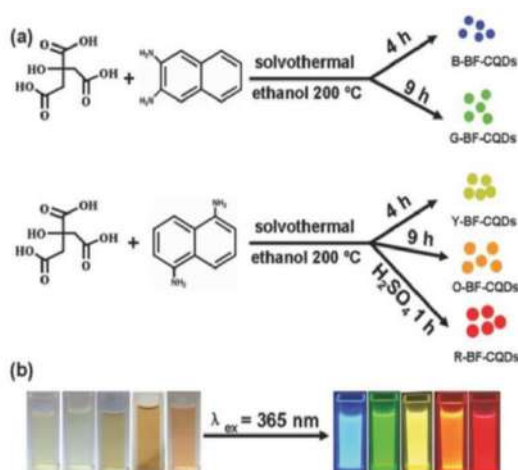
### The Strong Confinement Concept

Ultimately, this strong confinement rule has been verified by satisfying the requirements of  $\alpha^*B \gg R$  and  $\alpha^*h \gg R$  under the aforementioned circumstances, and the isolated size quantizations of an electron and a void may be the dominant part [62,63]. For a strong confinement regime, two basic conditions must be satisfied: the electrostatic part of the electron–hole pair interaction is slight and acts as a disruption, whereas the other shows self-sufficient electron/hole behavior as the aforementioned criteria are fulfilled. The visual spectrum was later confirmed scientifically, consisting of a series of lines entirely due to transitions between the sub-bands [61,62,63]. The fundamental model predicts a change in energy as a function of crystallite size as follows:

$$\Delta E \approx \frac{\hbar^2 \pi^2}{2\mu r^2}$$

Where the exciton's mass  $M$  is replaced by a decreased exciton's mass, and  $\mu = (m_e^* \cdot m_h^*) / (m_e^* + m_h^*)$ .

In a summary, the quantum confinement phenomenon occurs when the particle size is so small that it physically limits the electron and the electron alters its energy to compensate for the decreasing particle size; moreover, as soon as the contiguous orbitals shrink discontinuous energy levels arise rather than continuous energy bands as seen in solid materials. As a result, the energy band gap is governed by the particle size or shape, which has a significant impact on the PL [64,65] and differences in diameters result a wide range of emissions [64, 65] as multiple research works have correlated photoluminescence and particle diameter. Using a solvothermal approach, Fan and colleagues created multicolored luminous CDs by regulating the carbonization of citric acid (CA) and diaminonaphthalene (DAN) as shown in figure 3a, under the ultraviolet band ( $\lambda_{ex} = 365$  nm) the component radiated blues, greenish, yellowish, orange and red hues as shown in figure 3b [65] which depict the growing particle sizes of 1.95, 2.41, 3.78, 4.90, and 6.68 nm respectively. Similarly, Lee and colleagues used an electrochemical technique to make particle-size dependent fluorescence such as blue, greenish, yellowish and red-emitting CDs [66].

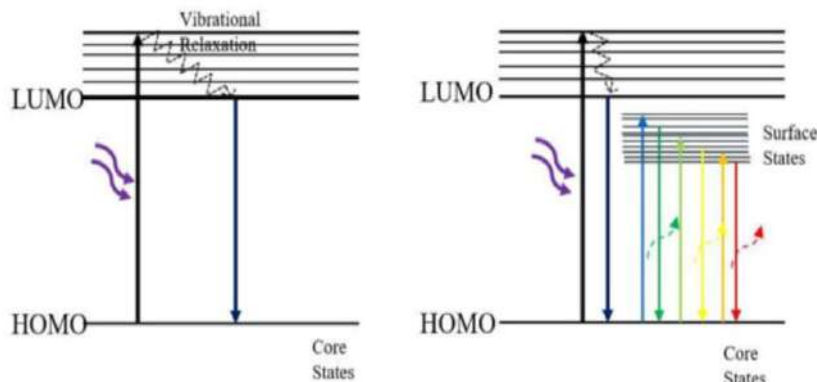


**Figure 3 :** (a) Solvothermal treatment of CA and DAN to shift MCBFCQDs from blue to red (b) Photographs of MCBFCQDs daylight view (left) and illuminating pictures (right) in UV light (excited at 365 nm) [65].

Despite the fact that quantum confinement is one of the most frequently recognized processes for explaining CD fluorescence, several studies are available that invalidate size-controlled emission levels. Hueso and associates, flashed pyrolyzed citric and EDTA for making undoped and nitrogen-loaded carbon-based quantum dots with identical PL emission at 420 nm despite their varied average diameters [67], as Dai and associates, predicted that PL might be caused by individual sp<sup>2</sup> groupings in the sp<sup>3</sup> carbon matrix causing  $\pi$  to  $\pi^*$  electron shifting within the molecular orbitals keeping the sp<sup>2</sup> structure unchanged and thus the fluorescence will be unaffected by the change in particle size [68] as this predicted theory is still the most widely accepted explanation for excitation-independent fluorescence responsiveness. Aside from that, several studies in the literature suggest that CD's PL emissions are intimately linked to a combination of the aforementioned aromatic sp<sup>2</sup> structural morphology and the surface condition of the CDs' [67, 69-71].

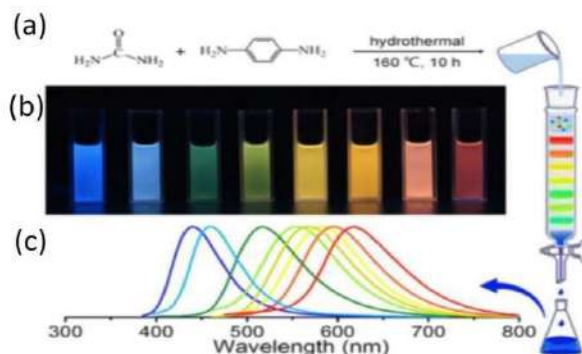
### (B) Emissions From The Surface State

The surface trapping of functional groups on the carbon dots and other imperfections referred to as the surface states of CDs.



**Figure 4:** Surface state induced illumination [76] is depicted in a simplified Jablonski diagram.

The electronic levels and electron mobility observed within the band structure of the filled molecular orbital (HOMO) and unfilled molecular orbital (LUMO) levels are displayed in the Jablonski diagram (Figure 4). The PL of surface state is explained by the phenomena of surface excitation and emission means that after absorbing a photon by surface moieties, HOMO electrons will move to the LUMO energy region followed by a non-radiative vibrational relaxation process as the momentum of electrons wasted by changing to other phonon modes as kinetic energy known as vibrational relaxation is a quick transition and don't usually modify the primary electronic state [72,73]. Subsequently electrons emit energy as photons after vibrational relaxation and revert to the HOMO energy states; thus, fluorescence is a sluggish process that takes between 10<sup>-9</sup> and 10<sup>-7</sup> seconds to complete. In general, the oxygenated functional units, such as (COOH, C=O, C-O-C), nitrogen and sulphur groupings exposed to the starting precursor material and the production parameters are common to all the carbon dot surfaces, then sp<sup>2</sup> hybridized carbon structures are disturbed by sp<sup>3</sup> configurations causing imperfections in electronic distribution system [74] and incorporates various energy levels resulting to broad emission peaks [75]. The presence of localized surface states modifies the fluorescence characteristics by modifying the energy band gap of the CDs [74,76] as targeted surface is one of the most widely used strategies to get a wide range of fluorescence emission from CD's. Therefore urea and p-phenylenediamine were hydrothermally carbonized by Xiong's group, and successfully created CDs of eight different emission colors ranging from blue to red (Figure 5), and numerous different CD's were collected using quartz column chromatography equipment based on their polarity [76] to verify the aforementioned theory. Compositional analysis revealed that carboxyl concentration had a significant effect on the PL properties by causing surface flaws; a higher level of oxidation was responsible for red shift of emission spectra. Furthermore, Zeng and colleagues created green emitting CDs from citric acid and ammonia and concluded that oxidized -C=O groups were involved in green emission whereas surface hydroxyl sites were involved in red emission spectrum [75].



**Figure 5:** (a) One-pot hydrothermal preparation and purifying technique for CDs with distinct photoluminescence characteristics, (b) Eight samples irradiated under 365 nm Ultraviolet light (c) Photoluminescence spectra of the eight samples respectively[76].

Despite the fact that most CD's exhibit pH-independent emission bands, the addition of binding sites can have a positive influence on CD's illumination properties as Basu and Mandal developed pH-sensitive CD's in which the esterification of -COOH and aromatic -OH groups has been associated with the change in quantum yield

efficiency and relocation of emission peak in a pH-dependent manner [72]. Besides to that, Zhu and his colleagues discovered that the existence of NH<sub>2</sub> and COOH molecules in hair fiber-derived CDs caused pH-dependent fluorescence behavior patterns [77]; therefore, the above surface functional groups changed the characteristics of the CD's causing them to behave like amphoteric amino acids with changing isoelectric values and dissolution coefficients that have controlled the CD's emission dependency on pH, as the assimilated CD's containing defective regions that cause excitation-dependent bursts, non-radiative mixing and CD's responsiveness to external conditions [64,69]. As a result, surface modification (surface functionalization) enables the production of a thin organic covering on the surface resulting, excitation independent fluorescent discharges, photo-stability [64,78] and high quantum yield efficiency of Carbon Dots. Ultimately, surface functionalization is shown to have a substantial effect on the photophysical properties of CDs.

### (b) Emissions from Molecular States

The molecular fluorescence originates when biological fluorophores are used as the raw material for CD formation, these compounds can couple with the edge molecules of Carbon dots or through non-covalent interactions to produce ( $\pi$  or n) -  $\pi^*$  transitions [47,54,79,80]. This feature was discovered by Giannelis and his colleagues when they produced the CD, which exhibited single-stimulated individual PL activity with a quantum yield of 50% [81], therefore carbogenic core's anionic fluorophores, are thought to be responsible for the illumination. Furthermore, when the pyrolytic temperature is raised, the majority of the fluorophores are destroyed in the formation of the carbogenic core, leading to a lower quantum yield and red-shifted fluorescence output as illustrated in Figure 6, the cyclization and polymerization of components at low temperature leads to the polymeric CD's that were injected with fluorophores to achieve greater fluorescence. CD's synthesised by pyrolyzing citric acid and amides, Jamshidi and his colleagues extracted all the emission spectra from each emission centre [79] and allows the temperature to move forward, and found that the dehydration processes caused by powerful aromatics, grows more complex structures with distinct emission peaks and inside the polymeric structure, the carbonization also caused aromatic molecules to transition to the carbogenic core, resulting in reduced quantum yields and extending the reaction time has also shown comparable data sets in few experiments [79,82].

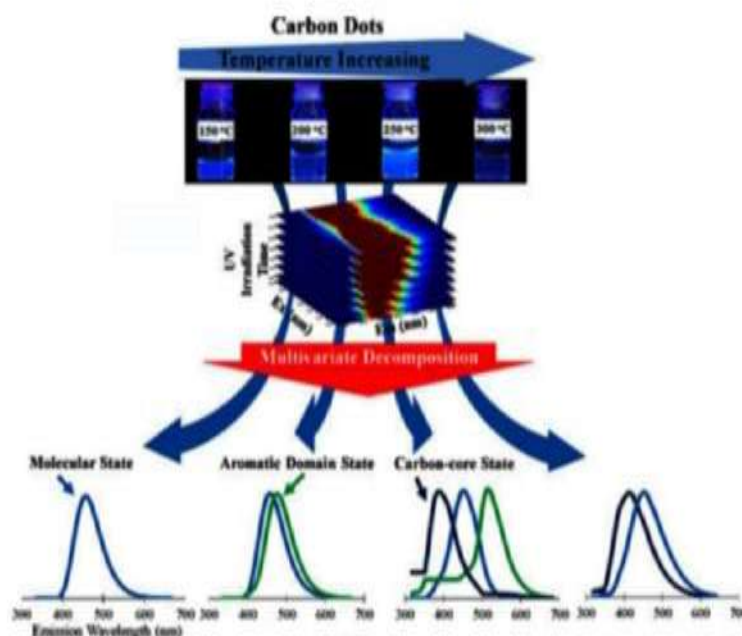
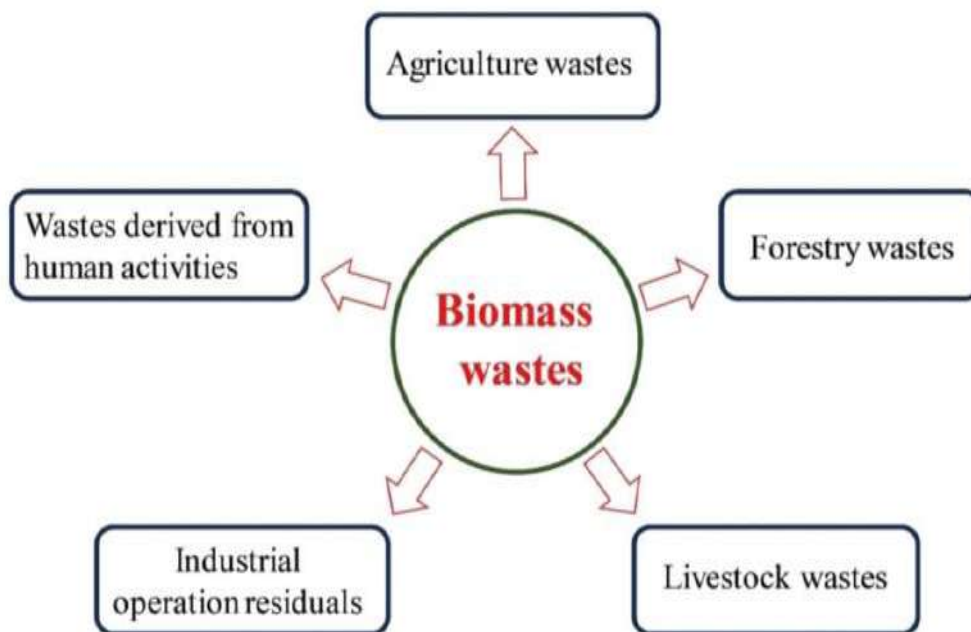


Figure 6: The emission spectrum has just been associated to the molecular, aromatic, and carbon core states as temperatures gradually extended [79].

Even though the above-mentioned processes are the most widely accepted explanation of CD's fluorescence behaviour, they are still controversial and emissions caused by a mixture of different nanostructures making it difficult to unravel. As a result, developing a good model will need further research in the future.

### C-Dots Synthesized From Biomass Sources

Many researches on carbon nanostructures from biomass precursors have been done, as shown below in (fig 7).



**Figure 7:** Main sources of biomass waste.

Biomass is classified as organic plants and other natural stuff produced through photosynthesis utilize water and CO<sub>2</sub> as reactants. Biomass generates around 104.9 petagrams of carbon per year and produces a carbon framework, with the benefit of being low-cost, abundant and limitless. Furthermore, biomass combined with clean synthesis techniques may greatly reduce carbon emissions and also avoid the use of toxic chemicals. Biomass is mostly composed of cellulose, lignocellulose and lignin concentrations ranging from 40–60%, 20–40%, and 10–25%, respectively [83]. As a result of its high carbon content biomass has been used as a source of carbon-derived compounds, such as charcoal and activated charcoal, for instance eggshell powder, prawn shells, bananas, lotus root, neem leaves, flower petals, cactus, bombyx mori silk, garlic and rice bran are some of the renewable sources of carbon used for making CDs [84-86]. Cellulose is a linear polysaccharide composed of D-glucose molecules bonded together as cellulose is the most prevalent quantity in existence, accounting for 50% of all natural materials. In a conclusion, there are several opportunities to use cellulosic biomass to make CD's, including inexpensive cost of production-costs excellent biocompatibility, dependability, and lack of complexity. In addition, cellulose has many—O<sub>2</sub> modules, including hydroxyl and ether intermediates, which can improve the structural and optical characteristics of CDs [72]. Finally, the majority of biomass extractives including heteroatoms (e.g. N, S, Zn, Mg etc. ) as heteroatom loading and outer layer crosslinking are significant aspects responsible for increased emission spectra (PL) [64]. Employing natural cellulose derivatives with such dopants provides additional advantages over simple pure chemicals. According to recent findings, CD's synthesized from biomass precursors have antioxidant activity in addition to PL emission activity, thus CD's with antioxidation ability serving as an alternative breakthrough in the literary works of quantum dots (QD) and also adds a new dimension for various research application fields. Although antioxidant components have played a key role in the pathogenesis of so many diseases and ailments [87], C-dots with antioxidant and anti-inflammatory potential serve as a new turning point in literary works, in comparison to other inorganic fluorescent nanoparticles, such as noble metal nanoparticles and semiconductors.

### Synthesizing Procedures Of Carbon Dots

As indicated in the diagram, there are various routes for the production of CD's, and which can be categorized into two types. One is a top-down route and the other is a bottom-up route (Figure 8). The former crushes large carbon structures such as fullerene, carbon tubes, or graphene into tiny chunks, while the latter integrates tiny molecules such as simple sugars under different operational conditions, creating carbon dots [47,51,55,88]. Regardless of the synthesis route employed, it is critical to remember that the synthesis process influences the size, functional groups, and colloidal stability of CDs. Thus, the physicochemical and optical properties of CD's are directly influenced by the synthesis method [46,88].

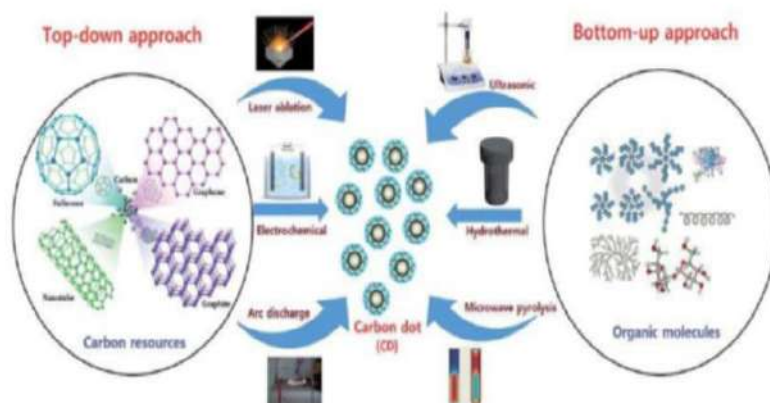


Figure 8: Illustration of potential carbon-dot-preparation synthetic techniques [89].

### (L) Top-Down Strategy

As top-down techniques are often used to convert graphite powder, multi-walled carbon nanotubes (CNTs), graphene, graphene oxide sheets, carbon fibers, soot and other substances with excellent  $sp^2$  geometries into CDs [51,88]. Arc discharge, laser ablation, acid oxidation and electrochemical treatment are the most popular procedures, and are discussed in detail in the next subsection. Meanwhile, there have been reports of CD's synthesized by solvothermal techniques [90,91], chemical exfoliation [92], reactive ion etching [93] and photo-Fenton processes [94]. Typically, top-down approaches are difficult and perhaps even toxic to the environment as they are not ideal for large-scale synthesis, [51] as some of them have been explored here.

#### (1) By Oxidation Route

In this process, strong oxidizing agents are used to decompose carbon structures into nanoscale levels. Mittal and Kushwaha [95] refluxed MWCNTs with strong  $HNO_3$  and  $H_2SO_4$  acids as the carbon tube lining and heads were oxidized to form carbonyl, carboxylic, sulfonic and nitro groups through oxidation as shown in Figure 9 as some layers under the upper layer oxidized with time, causing the nanotubes to fold and buckle and then these carbon tubes collapsed completely to form CDs. Similarly, lampblack particulates [96], carbon nanopowders [97] and carbon black [98] have been oxidized using nitric acid. The emission wavelength of CD's can be altered by varying the carbon supply and the oxidizing factors [48,52].

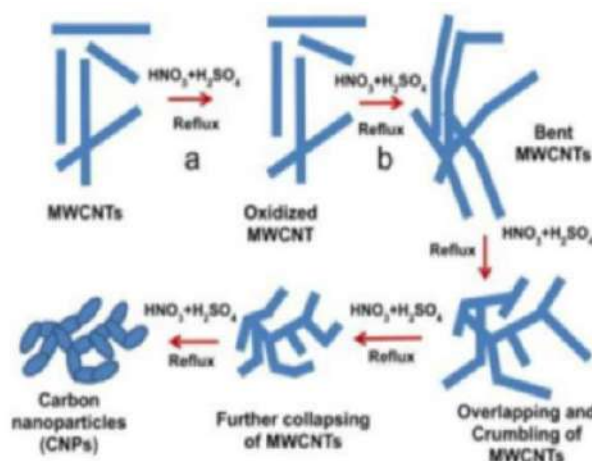


Figure 9: Over-oxidation of multiwalled carbon nanotubes [95] is proposed as a process for the creation of carbon nanoparticles.

#### (2) Through Laser Irradiation Process

When carbon-based substances are submerged into a fluid medium and a burst laser beam is directed on the desired resource, the point of focus is heated, melted and vaporized resulting in a stream of nanoparticles [99], which are submerged in a solution medium for simpler extraction as this method is often thought to be quicker and easier [99,100]. For comparison purposes, Du and colleagues used this sputtering technique on graphite oxide and then uniformly distributed graphite oxide in 3 different mediums and discovered that the CD emission peaks were at different wavelengths, even though the size distribution was similar [101] to that of Koshizaki and his group produced CD's on nanocarbon substrates [102]. Both studies discovered that CDs made in a fluid

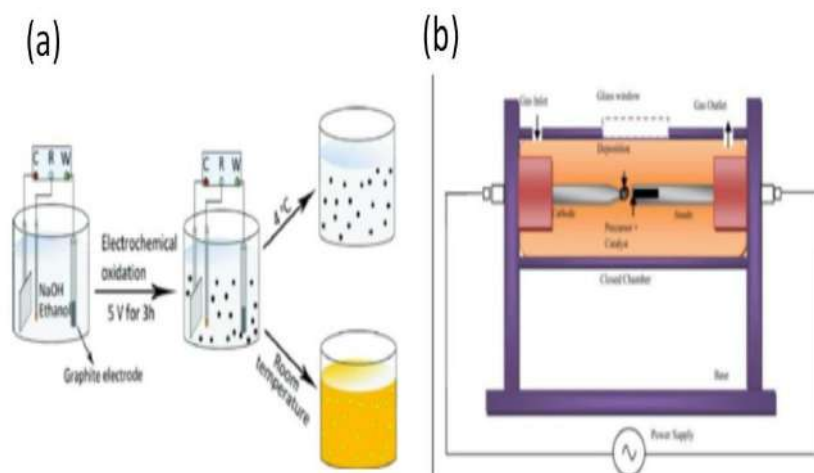
medium did not radiate any energy and surfactants made in polar solvents appeared to be responsible for higher PL by functionalizing and simple passivating the CD's surface. Du and his colleagues also noticed that as the molecular mass of the solvent increases, the spectrum becomes redshifted [101], which means that the solvent used has a significant effect on the fluorescent properties of the CDs following laser irradiation.

### (3) The Electrochemical Technique

The electrochemical technique is a chemical chopping procedure that uses an electrolytic solvent to break big carbon antecedents such as graphite rods, carbon nanotubes, carbon paste, and carbon fiber, while ionic liquid, acetonitrile with tetrabutylammonium perchlorate, and  $\text{NaH}_2\text{PO}_4$  are some of the electrolytes that can be employed in the whole process [104]. The illuminating characteristics, morphology and surface states of CDs can be easily changed by optimizing the electrochemical processing parameters such as the electromagnetic field, electrolyte content, electrode diameter and heating [48,103,104]. Liu and his colleagues prepared CDs utilizing a multiple electrode arrangement with graphite, platinum metal plates and silver/AgCl as the active counter and sample electrodes, where a (NaOH/Ethanol) blend as the medium [103]. Investigators found that higher potential corresponds to larger CDs as Long and colleagues also achieved nitrogen-immersed CDs with two different electrode setups, the two platinum layers served as alternating electrodes and an idea of ethanediamine and pyrocatechol in  $\text{H}_2\text{O}$  as the electrolyte [104]. Thus the use of an electrolyte as a precursor material for CD synthesis allows for a far more constrained and low-cost preparation route.

### (4) Electrical Discharge Method

Two reference electrode needles are inserted into a liquid/gas container in the electrical discharge technique as given below in (Figure 10).



**Figure 10:** (a) CQD formation by oxidation reaction of graphite in basic alcohols (left) [103,105] and (b) Diagrammatic representation of an electrical discharge setup (right).

The anode is always made of carbon, whereas the cathode is usually made of graphite [105], as soon as the current flows it creates superheated plasma that vaporizes the carbon antecedent; after a continuous current is maintained between the connections the vaporized carbon clumps travel towards the cathode to be collected in the gaseous state [105,106]. In general, this is a widely used approach for producing CNTs and this method was later utilized for manufacturing CDs for the first time by Xu and others [50,107] who discovered CDs in the purification of unrefined soot, as they subsequently used soot oxidation and gel electrophoresis to separate the CDs. Despite the fact that the oxidizing activity of soot increases the oxygen content of CD's produced soot from the glow discharge method, it contains complex impurities, making further separation difficult [108].

### (LI) The Bottom-Up Strategy

Bottom-up approaches mostly commonly used approaches for synthesizing CDs, in which molecular substances such as polysaccharides, esters, scaffolds, celluloids, and polymeric mixtures are ordered in morphology by using different processing steps such as decomposition, hydrolysis, and microwave assisted/hydrothermal conversion [48,49]. We can also change the features of CD's by altering the operational circumstances, making them suitable for better application purposes [50,53], although some routes are described below:

#### (1) Carbonisation Through Hydrothermal Means (HTC)

One of the most commonly used techniques for making CDs is the HTC/Solvo thermal analysis technique [54,55], which is inexpensive, environmentally benign, and harmless because it features simple equipment

requirements, high extraction efficiency, and the ability to synthesize on a massive scale [109]. In this method, the starting material is processed at a regulated time and temperature under autogenous pressure in an airtight hydrothermal reactor, and CDs are refined by purifying the resultant solution [48,545,109], since the main constraint of HTC in CD synthesis is inadequate size regulation [109]; therefore, purification plays a significant role in creating a narrow size distribution of the CD solution; for instance, filtration, centrifugation, quartz column chromatography, and dialysis are some of the purification processes [110]. Carbon precursors (cellulose, carbohydrates etc.) go through a sequence of events in HTC processes, commencing with disintegration, which breaks down long-chain components like cellulose into oligosaccharides, sucrose and sugars [111,112], latter isomerization, dehydrolysis and disintegration of these tiny molecules resulted in an intermediary products such as furfurals, carboxylic acids and aldehydes [111–113]. The core nuclei are formed when these intermediates undergo polymerization, condensation, dehydration and aromatization processes; therefore, the oxygen/nitrogen subunits in the solution grow on the surface, forming CDs with a core that is hydrophobic in nature and a rich functional group as hydrophilic shell [111–114], the particle morphology, size distribution, crystalline structure and surface characteristics of CDs can be controlled by varying the hydrothermal solution configuration, reaction temperature, solvent characteristics, addition of mixtures, and duration of time [115]. Table 1 summarizes some of the recent uses of CDs derived from biomass by HTC.

**Table 1:** Table Of Hydrothermal Way Of Preparation Of CD's Derived From Biomass.

Biomass Type	Temp.	Time	Mass Yield	QY	Application
Lobster Shells	200°C	6 hrs	0.26%	12.70%	Solar Cells
Shrimp Shells	180°C	15 hrs	-	-	Electrocatalyst
Corn Stalks	160°C	10 hrs	-	7.6%	Fe <sup>2+</sup> and H <sub>2</sub> O <sub>2</sub> Detection
Pomelo Juice	200°C	12 hrs	-	18.7%	Cr <sup>6+</sup> detection
Shrimp Shells	180°C	15 hrs	5%	-	Electrocatalyst for ORR
Shrimp Shells	180°C	15 hrs	15%	-	Electrocatalyst for ORR
Prawn Shells	180°C	12 hrs	18%	-	Nitrite Detection
Prawn shells	200°C	8 hrs	-	9.0%	Cu <sup>2+</sup> Detection
Fruit Extract	180°C	5 hrs	-	16.0%	Cell Imaging
Fruit Extract	180°C	5 hrs	-	13.0%	Fe <sup>3+</sup> Detection
Grape Peels	180°C	6 hrs	-	3.1%	Fe <sup>3+</sup> Detection
Goose Feather	180°C	40 mins	-	17.1%	Fe <sup>3+</sup> Detection
Fish Scales	200°C	24 hrs	-	17.08%	ClO <sup>-</sup> Detection
Apple Juice	150°C	12 hrs	-	4.27%	Cell Imaging
Lime Juice	180°C	7 hrs	-	40.00%	Hg <sup>2+</sup> Detection
Garlic	200°C	3 hrs	-	17.50%	Cell Imaging
Waste Frying Oil	100°C	5 mins	23.22%	3.66%	Cell Imaging
Bagasse	180°C	3 hrs	9.30%	12.30%	Cell Imaging
Milk	180°C	2 hrs	-	12.00%	Cell Imaging
Rapeseed spent meal	180°C	3 hrs	9.42%	9.20%	Food Packaging
Orange Peels	180°C	12 hrs	12.30%	36.00%	Photocatalyst
Bagasse	220°C	1 hr	-	2.70%	Catalyst
Pomelo Peels	200°C	3 hrs	-	6.90%	Hg <sup>2+</sup> Detection

## (2) Method of Microwave Irradiation

This is a quick synthesis process that involves dissolving the carbon source in water or a buffer solution and placing it in the microwave for a few minutes. This technique is extremely convenient compared to other techniques, and reactions may be conducted without the need for temperature variation, even using a home microwave oven [48,116]. Heat is created in microwave devices via frictional forces among the molecules in an electromagnetic field and is directly linked to their dielectric permittivity [117]. Whenever biomass precursors are kept in the microwave [118], the amorphous areas are more reactive than the crystalline parts. As a result,



restrictions related to the biomass's complicated structure and difficulty in managing irradiation power might impair repeatability [114], as shown in table 2.

**Table 2:** Cds Created With A Microwave And Biomass Sources.

Biomass Type	Reaction Parameters	QY	Emission Wavelength (nm)	Application
Wool	200 °C for 60 min	16.3%	450 nm	Sensing Glyphosate
Lotus Root	800 W for 6min	19.0%	435 nm	Sensing Hg <sup>+</sup> and cell imaging
Goose Feather	180 °C for 40 min	17.1%	425 nm	Sensing Fe <sup>3+</sup>
Silk fibroin	200 °C for 4 hrs	20.0%	460 nm	Bioimaging
Kelp	200 °C for 1.5 hrs	23.5%	450 nm	Sensing Co <sup>2+</sup>
Algal Blooms	600 W for 5.8 min	13.0%	438 nm	Cell imaging
Sesame Seeds	800 W for 15 min	8.02%	440 nm	Sensing Fe <sup>3+</sup>

### (3) The Ultrasonic-Assisted Approach

The exhibited ultrasonic-assisted method for creating C-dots has the merits of being both inexpensive and simple to utilize. C-dots can be prepared by ultrasonically treating blends of solvents and carbonaceous materials and their characteristics can be controlled by modifying control variables such as ultrasonic frequency, response time and the percentage of solvents and carbonaceous materials. Park and colleagues [119] suggested a simple strategic approach for large-scale production of water-soluble C-dots generated from waste-carbon precursors, supplemented by ultrasonication and achieved a quantity of 120 grams of C-dots derived from 100 kg of mixed garbage for in-vitro bio-imaging and these C-dots had decent water solubility, reasonable photostability, improved photoluminescence and little cytotoxicity.

### (4) Other Approaches

Despite the fact that microwave-aided and HTC methods are the most frequently utilized bottom-up fabrication methods, few alternative molecular compound-based strategies have been established. Kang and his colleagues created CD's by ultrasonically treating sugar mixtures in presence of an alkaline or acidic environment, and the resulting CDs appeared extremely stable, with a QY of nearly 7% [120]. Tan and his colleagues contributed by synthesizing CDs from sago garbage using the direct pyrolysis method and then dissolved the pyrolytic charcoal in water to achieve a final CD mixture, which emitted a blue colour spectrum after the solution had been ultrasonically processed and centrifuged [121].

Top-down approaches usually require more expensive hardware, associated infrastructure, and more energy (heating, electric power or radiation [122]). To avoid clustering of nanostructures, several top-down approaches include hazardous treatments such as strong alkali/acids, non-polar organic solvents, and reducing and stabilizing agents [123]. Top-down approaches on the other hand, offer the benefit of synthesizing CDs, with a more precise size and shape. The bottom-up technique involves a low operating temperature and power to regulate the elemental structure of the CDs. Bottom-up approaches also results in nanostructures with fewer imperfections as well as more uniform chemical characteristics [122,124]. Table 3 outlines the drawbacks and benefits of various fabrication processes in terms of CD quality.

**Table 3:** Advantages And Disadvantages Of Synthesizing Processes Based On Quality

Approach	Method	Advantages	Drawbacks
Top Down Method	oxidation	<ul style="list-style-type: none"> <li>• Provide CDs surface with high carboxyl, carbonyl and hydroxyl groups</li> </ul>	<ul style="list-style-type: none"> <li>• Low photoluminescence</li> <li>• Contaminates removals with time intensive washing and filtration steps</li> <li>• Environmental impact of toxic reagents (strong acid/alkali)</li> </ul>
	Laser ablation	<ul style="list-style-type: none"> <li>• High-purity particles determined by the purity of the target and ambient media</li> <li>• Control the emission properties through solvent</li> <li>• longer ablation time for synthesis of high smaller-sized nanostructures</li> </ul>	<ul style="list-style-type: none"> <li>• Difficult to control size distribution, agglomeration, and crystal structure</li> <li>• Requirement of stabilizing agents, and various synthetic capping agents</li> <li>• complicated operation and high cost limit</li> </ul>
	Electrochemical release	<ul style="list-style-type: none"> <li>• abundance of raw materials</li> <li>• ease of operation</li> <li>• potential for mass production</li> <li>• low cost setup</li> <li>• Not involving any harsh or toxic chemicals</li> </ul>	<ul style="list-style-type: none"> <li>• Non uniformity in size distribution</li> <li>• Low photoluminescence</li> <li>• Difficulty in purification process</li> </ul>
	Arc discharge	<ul style="list-style-type: none"> <li>• Nanoparticles have good water solubility</li> <li>• Simple and fast procedure</li> </ul>	<ul style="list-style-type: none"> <li>• Large particle size distribution</li> <li>• Very high temperature process</li> <li>• Separation difficulty of nanoparticles from impurities</li> </ul>
Bottom up Method	Microwave Digestion	<ul style="list-style-type: none"> <li>• High oxygen containing groups on the surface</li> <li>• Low cost setup</li> <li>• Simple, fast and environment-friendly preparation</li> </ul>	<ul style="list-style-type: none"> <li>• Poor control of the size of particles</li> <li>• Irregularities in crystalline and amorphous regions in biomass effects the reproducibility</li> </ul>
	HTC	<ul style="list-style-type: none"> <li>• Easy functionalization of nanoparticles</li> <li>• High water solubility</li> <li>• Facile instrumentation and process</li> <li>• High atom economy</li> <li>• Easy preprocessing of raw materials</li> <li>• Low temperature process</li> </ul>	<ul style="list-style-type: none"> <li>• Poor control of the size of particles</li> <li>• Impossible to observe the reaction</li> </ul>

### The Most Important Factors Affecting C-Dot Properties

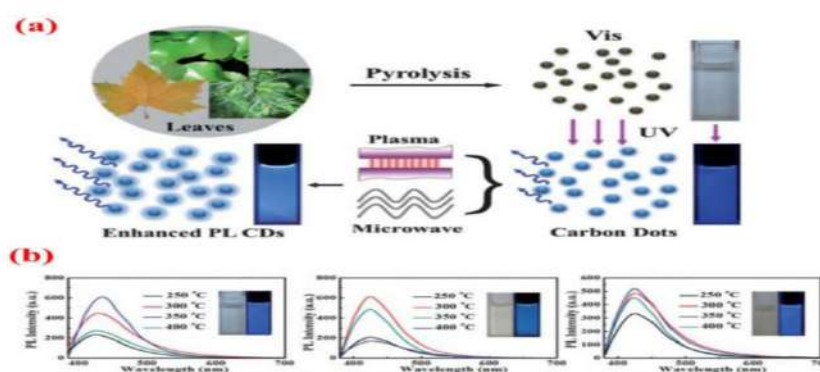
The four key parameters regulating the fluorescence features of C-dots are the quantum confinement effects, bandgap transition, surface passivation, and surface defect states [125–127]. According to several well-defined analyses [128], the outer edge state is one of the most essential factors for the fluorescence emission properties. Surface modification of C-dots often improves the features that begin with the surface state groups of C-dots, which can often cause imperfections on the edges of C-dots and hence, modify their luminous features. As soon as the quantity of surface oxidation of C-dots rises, more defects are formed to trap more excitons, causing the emission lines of the C-dots to become red-shifted. Thus, surface modification is important in controlling the luminescent properties of C-dots as it can significantly change the emission spectrum [129], increase the PL emission intensity, narrow the fluorescence peak spacing and promote the water dissolution rate [130]. According to new study, the luminescence behaviour of C-dots is controlled by a combination of two or more of the four parameters, rather than just one of them alone [131,132]. The impact of the synthesis parameters on the characteristics of C-dots was explored.

#### (1) The Influence of Raw Materials

The C-dot fluorescence characteristics are regulated by the building elements employed in the C-dot synthesis. For example, when C-dots were created using pineapple peels and cucumber peels and using the same synthetic technique, they found noticeable changes in key fundamental properties [133], however, after several weeks of incubation, analysis showed that C-dots created using pineapple peels were entirely destroyed, whereas C-dots made from cucumber peels remained stable. In addition, yeast have developed on the faces of pineapple-derived C-dots but not on cucumber-peel-derived C-dots. As a result, C-dots derived from cucumber peels have a broader range of applications in electronic and live cell imaging, as Boruah and colleagues [134] discovered that C-dots derived from garlic peels, cane bagasse, and kalo husks using a similar synthesis route had significantly different quantum yields (13.8 percent, 4.5 percent, and 26.2 percent, respectively) and physicochemical properties.

### (1) The Impact of Synthesis Temperature

A carbonization procedure was used to generate fluorescent C-dots using biological precursors as the carbon sources. Because the carbonization process is an endothermic reaction, temperature has a significant impact on C-dot generation through a simple pyrolysis process. Zhu and coworkers [135] explored the effect of the heating rate on the photoluminescence characteristics of C-dots generated using different leaves (e.g., *Platanus orientalis* petals, palm fronds, lotus leaves, and pine boughs). When carbon materials were used for synthesizing C-dots, their optimum pyrolysis temperatures were significantly different (Figure 11). We can then predict that the thermal treatment will not be too low or too high; a small thermal treatment may limit the carbon antecedent from completely carbonizing into C-dots, and a high temperature may cause the carbon antecedent to become over-oxidized, thus destroying the morphology of C-dots and leading to a significant loss of the optical characteristics of the C-dots. Tan and his coworkers [136] explored the role of the operating temperature on the characteristics of C-dots made from sago residue, and the analysis revealed that as the pyrolysis temperature increased, the particle diameter of the C-dots shrank. In addition, the highest emission wavelength of the C-dots shifted to a gradual blue region with time. The morphological features of the end products were considerably affected by pyrolysis temperature. The influence of temperature on the hydrothermal technique was identical to that on the pyrolysis technique [137].



**Figure 11:** (a) A schematic depiction of the pyrolysis method for synthesizing C-dots from various plant leaflets [138]; (b) Excitation and emission spectra of matched C-dots obtained at various reaction temperatures (*Platanus orientalis* petals, lotus petals, and pine tips) [138].

### (2) The Contribution of Processing Time

The effects of the processing time and temperature on the optoelectronic characteristics of C-dots are comparable [135]. As we have discussed, excessive carbonization destroys the surface properties of C-dots whenever the timing is extended, and in the case of shorter reaction duration, the co-substrate carbonization is restricted, resulting in weak fluorescence emission from the C-dots. According to the current research, the influence of response time on the optical features of C-dots is temperature dependent, and the ideal reaction time is determined at the appropriate temperature. However, even if the reaction is carried out at an optimal response time, no beneficial end-product is produced unless the temperature reaches a certain higher value [137]. Devi and others [138] improved the response time for C-dots using an environmentally sustainable pyrolysis technique based on a substantial waste byproduct of the dairy and cheese industries, as these C-dots with a photoluminescence quantum yield of 11.4 percent were successfully used to detect selenite in solution after 30 min of pyrolysis and 220 °C of heating. Furthermore, prolonged reaction time may result in a considerable decrease in the photoluminescence emission intensity of the final yield. Bandi and associates [139] observed that the response time has a substantial influence on the fluorescence quantum yield (QY) of C-dots derived from onion waste. As the response time increased, the C-dots showed an increasing trend in QY, and a dropping trend was observed when the reaction time was extended further. Ngu and his colleagues [140] created C-dots from leftover rice husks and found a similar link between QY and reaction time.

### (3) The Influence of Ph Value

The effect of the solution's pH on the emission spectra of C-dots varies from carbon source to source using various synthetic approaches. Some C-dots prefer balanced pH [141-145], others thrive in acidified pH [146,137,145], and others are stable across a wide pH range [147,148]. The fluorescence emission strengths of C-dots produced from various biomass residues alter in accordance with just a change in pH value, allowing them to be employed as pH-sensitive monitors. Chunduri and his coworkers [149] used a hydrothermal technique to synthesize C-dots from coconut shells with an excess of hydroxyl and carboxyl units on their

surface. The c-dots experienced a consistent drop in photoluminescence strength as the pH value changed from 4 to 12. This is due to the carboxylate groups through protonation and deprotonation at different pH levels, resulting in a shift in the electrostatic charge behaviour.

#### **(4) The Impact of Heteroatom Co-Doping**

Several ways of improving the luminous characteristics of C-dots have been explored in the last decade [150–152]. Most researchers have used heteroatom loading to improve the characteristics of C-dots, because the incorporation of heteroatoms into the carbon core framework is capable of controlling the electrical characteristics as well as the central and subsurface chemical characteristics of C-dots. Nitrogen is widely doped into carbon compounds due to its similar atomic size to a carbon atom, which has 5 outermost unpaired electrons and better electron affinity than carbon atoms [153]. Similarly, by modulating the energy density states of the dots, sulphur atom doping increases the fluorescence emission intensity of C-dots [153]. In another study, Hu and his coworkers [154] utilized tea leaf remnants and concentrated H<sub>2</sub>SO<sub>4</sub> to make nitrogen and sulphur co-doped C-dots at high temperature, and the fluorescence quantum yield of as-prepared C-dots was 14.8, which was more than three times the QY of undoped C-dots.

#### **Properties of C-Dots Derived From Biomass Precursors**

C-dots are known for their exceptional photostability, persistent photoluminescence and easy surface functionalization that distinguishes them from bulk carbon materials. Some of the processing attributes are given below;

##### **Morphological Behaviour**

New C-dots are multi-dimensional agglomerations composed of carbon atoms and a few other elements in a spherical-like form. The SP<sup>3</sup> hybridized carbon atoms dominated the interior regions of the three-dimensional aggregates, with a fewer percentage of SP<sup>2</sup> hybridization coupled carbon atoms. C-dots have a crystalline structure that is almost similar to that of amorphous carbon and graphite [155-57]. The peak fluorescence emission colors of the C-dots have showed a red shift along with increasing particle size, indicating that they had a size distribution of less than 10 nm and hence displayed the "quantum confinement effect." Although the amounts of these elements vary depending on the synthesizing technique employed, the c-dots are mostly made up of C, H, O, and N atoms. Surface modification and other techniques that decorate the C-dot surface with amine (-NH<sub>2</sub>), hydroxide (-OH), and carbonyl (C-O-C) linked functional groups considerably increases the C-dot's aqueous solubility and make surface modification much easier, which may ultimately lead to an essential factor for large-scale applications of C-dots [158-160]. C-dots, which have a smaller particle size than conventional semiconductor quantum dots or other nanoscale sensor systems, can easily enter cells via endocytosis and thus have a wider application in cell imaging and the measurement of organic molecules in cells [150,161].

##### **Optoelectronic Properties of C-Dots**

Following are some of the opto-electronic properties of Carbon Dots that have been verified.

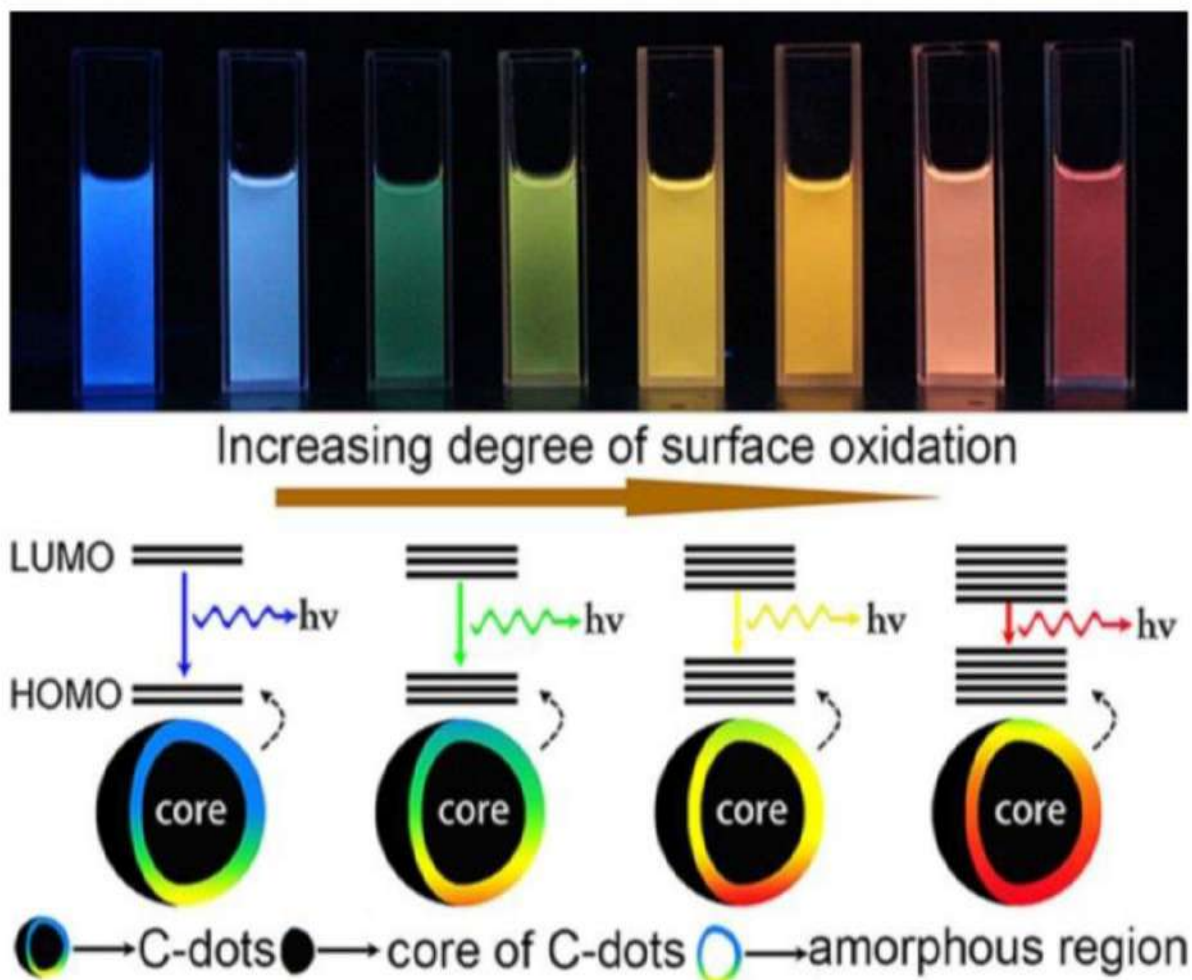
##### **(1) Ultraviolet-Absorption Emission Property**

C-dots possess a broad absorption range and provide a strong absorption edge in the ultraviolet to visible spectral region. C-dots produced via various synthesizing processes, using different precursors and dispersed in different solvents, possess visually recognizable absorption bands. C-dots frequently exhibit one or more absorption maxima in the UV to visible spectrum range [162,163,164], with a sharp absorption peak in the 220–270 nm wavelength range, which is attributed to the  $\pi$ - $\pi^*$  transition of C=C and C=N orbitals. The spikes in the 280-350 nm wavelength region are similar to the  $n$ - $\pi^*$  transition of the C-O and C=O bonds. The shifting of ligands on the edges of the C-dots is often linked to an absorbance peak between 350 and 600 nm [165].

##### **(2) Fluorescence Emission Characteristics**

As we all know, among the most noteworthy properties of C-dots, their inherent fluorescence provides a significant impact on their application point of view. The quantum confinement effect, emissive traps, electron-hole pairs, oxidized surface cracks and O<sub>2</sub> groups or aromatic structures were used to explain C-dots' excellent photo response, which include a broad emission spectrum, a restricted spectrum, size-dependent (or excitation wavelength-dependent) fluorescence emission, decent fluorescence consistency, up-conversion luminescence and strong photobleaching resistance. The exact luminous mechanism of the C-dots remains to be determined. Zhang and others [163] revealed that different kinds of organic solvents utilized for C-dot extraction affected the max located peak of the fluorescence emission spectra of C-dots produced from polystyrene foam waste. Surface modification using quasi-organic solvents is believed to generate discrete defects on the surfaces of the C-dots and encourage diverse emission sites, resulting changes in the peak position and intensity of the

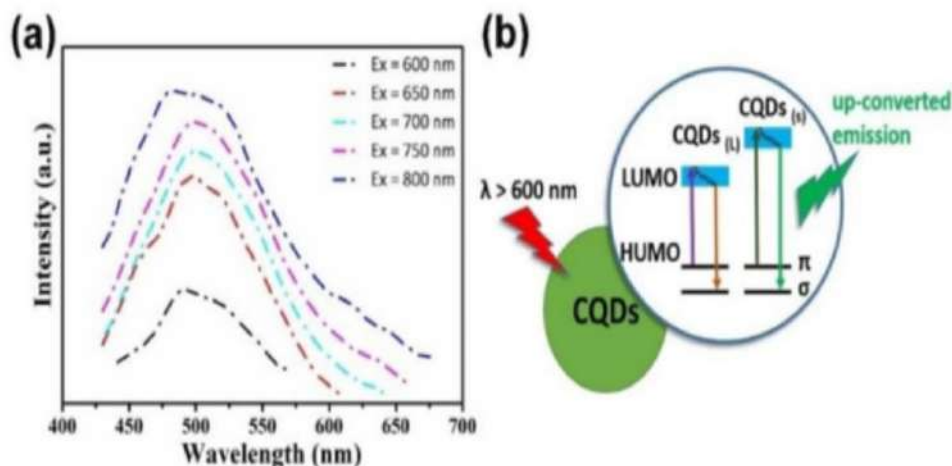
fluorescence spectrum. Ding and colleagues [169] came up with a novel way of using the hydrothermal method, in which a series of C-dots were synthesised and subsequently extracted from ethanol using quartz column chromatography. Despite having an equal crystallite size and graphitic morphology in their core, the emission max peak of these C-dots ranged from 440 to 625 nm (Figure 12), becoming more red-shifted as the degree of oxidation goes up. Therefore, the degree of surface oxidation was identified as a controlling factor in the C-dot fluorescence emission. In conclusion, we can say that the type of binding morphology between heteroatoms and the carbon core is the most important factor affecting the fluorescence properties of heteroatom-doped C-dots.



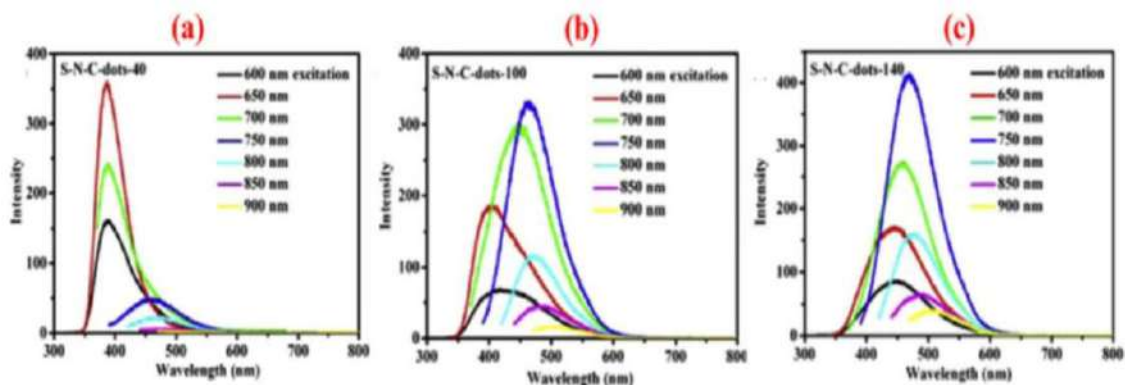
**Figure 12:** The functioning of C-dots with varied degrees of surface oxidation [170] with adjustable fluorescent brightness.

### (3) Fluorescence Emission Characteristics of Up-Conversion

Despite conventional down-conversion fluorescence emission spectrometry, C-dots produced from biomass waste shows distinctive upconversion fluorescence with a fluorescence emission wavelength shorter than the excitation wavelength [171,169,172]. Anti-Stokes lines and multiphoton active processes are the two most frequent causes of upconversion fluorescence. Wu and his colleagues [165] used walnut shells to make upconversion photoluminescent C-dots and established an electronic transition mechanism model to characterize the upconversion phenomena. The energy gap between the LOMO and HOMO is reduced by increasing the particle size of the C-dots. According to the electronic transition process, the electronic Anti-Stokes signals are formed by carbene ground-state multiplicity from the energy level of the orbitals. To excite the electrons, low-energy light with a wavelength of more than 600 nm is employed, which subsequently transits to the excited state with higher energy (LOMO). For this kind of irradiation, upconversion luminescence always occur when electrons revert to the bottom state (Figure 13). Sun and colleagues [169] confirmed that the multiphoton active process is the most likely mechanism for the upconversion luminescence of sulphur and nitrogen co-doped C-dots produced from hair fibers' (Figure 14). In-vivo imaging of C-dots with upconversion fluorescence offers considerable tissue penetration of the red light and little auto-fluorescence mixing within the red-light spectrum in the biological tissues.



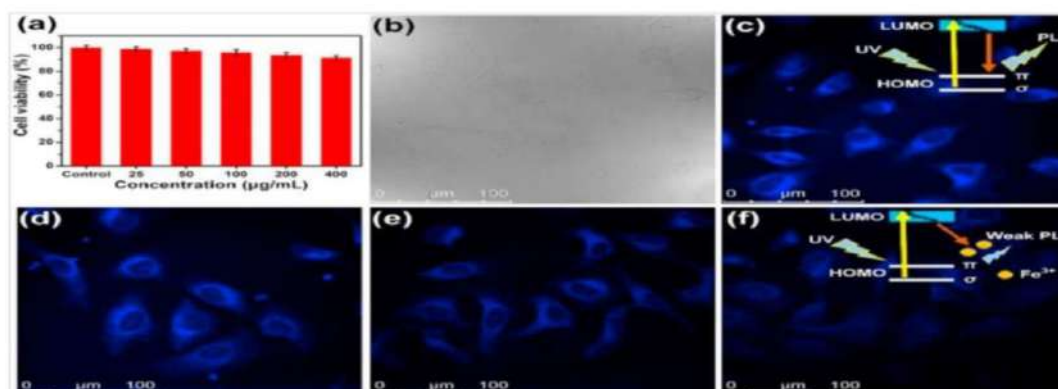
**Figure 13:** (a) illustration of the luminescent properties of C-dots manufactured by walnut shells (b). Depicts the processes of upconversion fluorescence in C-dots of various particle sizes[171].



**Figure 14:** The photoluminescence characteristics of S-N-co-doped C-dots produced from hair fiber at various temperatures are shown in the picture above, (a) 40 degrees Celsius; (b) 100 degrees Celsius; (c) 140 degrees Celsius. [169].

#### (4) Cytotoxicity and Biocompatibility of Carbon Dots

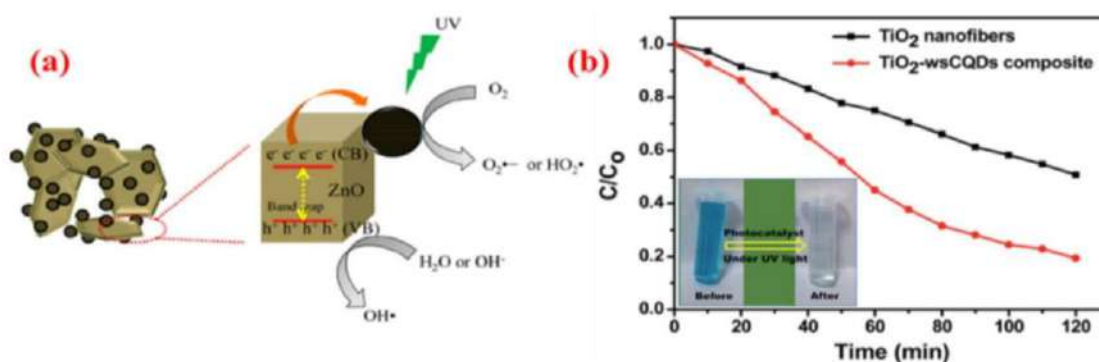
As previously stated C-dots possess outstanding optical properties and have a wide range of uses in bioanalysis. In contrast, C-dots have low cytotoxicity and high biocompatibility which are critical for in vivo cell and tissue imaging [173–175]. [174]. N and S co-doped C-dots (N/S-CDs) were produced from cellulose-based biomass waste, showing greater fluorescence quantum yield, nontoxicity and improved biocompatibility consequently, they were effectively assessed for intracellular scanning, as proven by Cheng and his colleagues [174] (Figure 15).



**Figure 15:** (a) HeLa cell survivability after just a day of incubation at various concentrations of N/S-doped C-dots derived from cellulose-based biowaste; (b–f) fluorescence images of HeLa cells housed on N/S doped C-dots (40 g/mL) under various conditions ((c): (a–c): solely N/S-CDs; (d–f): N/S-CDs with Fe<sup>3+</sup> at 10, 20, and 40 M, respectively) [175].

### (5) CD's Act As Photocatalyst

Some C-dots have outstanding photocatalytic properties or the capacity to increase the performance of other catalysts that were produced from orange waste peel extract and loaded onto ZnO by Prasannan and colleagues [176], behaving as C-dots/ZnO complex catalysts. The photocatalytic activity of C-dots/ZnO was raised by 15.7 percent after 45 minutes of UV light irradiation compared to that of the ZnO catalysts, indicating that C-dots had a substantial role in photocatalytic activity (Figure 16a). When electrons in ZnO's valence band are exposed to UV light, they are excited to higher energies and transferred to C-dots, leaving holes in the valence band and, avoiding recombination of electron-hole pairs. When electrons on C-dots interact with oxygen, superoxide ions ( $O_2^{\bullet-}$ ) are generated and when water interacts with the holes in ZnO, hydroxyl ( $OH^{\bullet}$ ), is produced, which can act as a potent oxidation agent for the degradation of naphthol blue-black (NBB) azo dye by oxygen radicals. Gupta and colleagues [177] synthesised spherical C-dots with oxygen-rich surface functionalities from lemon peel waste and immobilized them on electrospun TiO<sub>2</sub> nanofibers to organize TiO<sub>2</sub>-water-soluble carbon quantum dot (TiO<sub>2</sub>-wsCQDs) clusters, which were used to verify the photocatalytic activity of the TiO<sub>2</sub>-wsCQDs composite catalyst used for the breakdown of Methylene blue. The photocatalytic efficiency of the TiO<sub>2</sub>-wsCQDs was around 2.5 times greater than that of the TiO<sub>2</sub> nanofibers (Figure 16b).



**Figure 16:** (a) Diagrammatic representation of the C-dots/ZnO composites photocatalytic activity [176]. (b). Under UV illumination, photo degradation of MB in the presence of TiO<sub>2</sub> nanofibers and TiO<sub>2</sub>-wsCQDs composite (the attached image depicts the colour of the MB solution with and without degradation) [177].

### C-Dots Produced From Biomass Precursors Possessing a Wide Range of Applications

Carbon dots derived from biomass intermediates have been thoroughly examined for a broad range of applications, including in-vivo monitoring and targeting therapies, photocatalytic degradation, drug/gene delivery, fuel cells, led diodes, fluorescent dyes and fluorescent diodes. For example, the outstanding fluorescent qualities and abundance of surface functional groups of carbon dots demonstrate a high level of chemical sensing capabilities, which are the most extensively employed field of biomass waste-derived carbon dots. Carbon dots are also an ideal choice for biological imaging because of their great bio-compatibility and high photo-stability. Carbon dots can also be employed as energy storage systems due to their nano size, unique opto-electronic characteristics, superior electrochemical consistency and dynamic edge sites as shown below in (Fig 17).



**Figure 17:** CD characteristics and applicability are summed up in this figure.

### **(1) C Dots Act As A Super Sensing Material**

For a wide spectrum of analytes such as cations, anions, small molecules (glucose, thiols), macromolecules (DNA, proteins) and biological entities (cells, bacteria), Carbon Dots have been employed as quick response, efficient, and selective sensors [178]. This is because of their excellent water solubility, efficient instrumentation and flexibility to overcome fluorescence signal changes due to temperature, pH, surface charge and light absorption. Several ideas have evolved over the years to explain the interactions amongst CDs and compounds. Some of them are listed below:

(1) PET (Photoinduced Electron Transfer) is a redox process during which the stimulated electron in CD (donor) is passed to the substrate (acceptor), forming a network in between benefactor and receiver and then reverting to the lowest energy without fluorescence.

(2) Resonant Transferring Energy: When CDs' stimulated electrons revert back to the initial state, the energy is transferred to the sample if the two are housed within the same small spatial region; thus, the CDs' emission spectra coincide with the sample's absorbance values.

(3) Whenever the sample's absorbance spectrum and the CDs' emission spectrum cross each other, a portion of the light is absorbed by the sample, lowering the intensity of the excited electrons. Several biosensing configurations have been developed based on interactions with the sample. The most extensively used method is optical quenching, in which the strength of illumination decreases as the quantity of the sample goes up, while others have created luminescence amplification models. For instance, Shen and colleagues, for instance created chitosan-based CDs that sensed Ag<sup>+</sup> ions via fluorescence quenching [179], whereas dihydric alcohol-derived CDs for Ag<sup>+</sup> showed fluorescence amplified emission [180]. Besides that, logic gates relying on fluorescence enhancement and dampening with various samples have been developed in several investigations [181, 182]. Selectivity and responsiveness are the two basic parameters used to analyze CD's efficiency in sensing applications, as selectivity is assessed by the drop or increase in the luminescence of CDs towards the target sample at a set concentration. For CD's to have a high level of selectivity, they must be significantly distinct from other possible interfering compounds and for the best selectivity, the fluorescence enhancement/quenching percentage of the chosen sample over other chemicals should be at least 5 times [183,184]. Responsiveness is determined by the extent to which the fluorescence changes in response to the concentration of the sample, for which their linear range and the limit of quantification are used for better understanding. (Table 4) illustrates some of the sensing abilities of Carbon Dots.

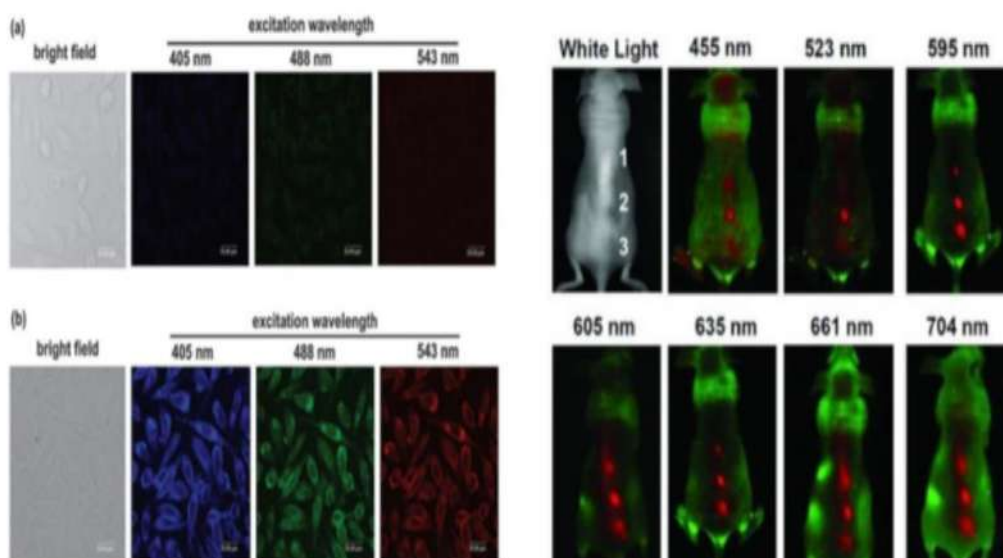
### **(2) For Bioimaging Analysis**

Owing to their excellent bioactivity and lack of toxicity, CDs have emerged as a promising alternative to traditional CdSe-ZnS quantum dots [185]. CDs have also shown promising in-vitro studies involving cellular uptake and in-vivo studies using rat models. For instance, in vitro investigations are being carried out to assess the bioimaging capabilities, localization, and cytotoxicity of fluorescent probes in accordance with the cells [186]. CDs have previously been used to image a variety of cells, including HeLa cells [187,188,189], HepG2 cells [190], NIH-3T3 fibroblast cells [191], LLC-PK1 [192], human lung cancer cells [193], MCF-7 cells [194] and human neural stem cells [195]. Zhai and his colleagues, created nitrogen-doped CDs from citric acid and 1.2 ethylenediamine (EDA), which significantly improved the PL performance characteristics and providing high-quality images of L929 cells (figure-18a) [196]. These cells are also found in cellular membranes and intracellular regions, which supports many of these observations. The ability of CD's to emit PL in the near-infrared (NIR) region incorporates efficient sensing material for in vivo monitoring because of the permeability of physiological tissue in the NIR area. Figure 18b shows an in vivo image of a mouse injected with CD's intradermally in three different locations [197].



**Table 4:** C-dots act as sensing material.

Group	Analyte	CD Precursor	QY%	LOD	Linear Range
<b>Cation</b>	Fe <sup>3+</sup>	citric acid/ tris	52%	1.3 μM	0-50 μM
	Hg <sup>2+</sup>	citric acid/ urea/ l-cysteine	25%	2 μM	0-40 μM
	Cu <sup>2+</sup>	citric acid / mesoporous silica	7%	23 nM	0-10 μM
	Cr <sup>6+</sup>	citric acid / diethylenetriamine	88.6%	-	0.01-50 μM
	Pb <sup>2+</sup>	Glycerol/ ethanolamine	-	15 nM	0.1-6 μM
	Ag <sup>+</sup>	Dihydric alcohol	3.02%	0.32 μM	0-90 μM
<b>Anions</b>	PO <sub>4</sub> <sup>3-</sup>	citric acid/ aminoundecanoic acid	-	51 nM	0.4- 15 μM
	ClO <sup>-</sup>	Fish Scale	19.3%	50 nM	0.1-300 μM
	S <sup>2-</sup>	citric acid / ethylenediamine	-	0.78 μM	0-25 μM
	CN <sup>-</sup>	citric acid / branched poly ethylenediamine	42.5%	0.65 μM	2-200 μM
<b>Others</b>	Glucose	citric acid / ethylenediamine	-	0.35 μM	10-200 μM
	Cysteine	Citric acid / Ammonia	35.4%	0.79 nM	0-50 μM
	Alkaline phosphatase	Activated carbon /H <sub>2</sub> SO <sub>4</sub> /HNO <sub>3</sub>	2.2%	1.1 U/L	16.7-782.6 U/L
	Tetracycline	Citric acid / K <sub>2</sub> HPO <sub>4</sub>	-	5.48 nM	0.02-14 μM



**Figure 18:** (a) Laser-scanned morphology images of L929 cells without labeling (left (a)) and EDA-CDs-labeled L929 cells (left (b)), and (b) In-vivo fluorescence views of Cdots M-injected rodents at several wavelength ranges [196,197].

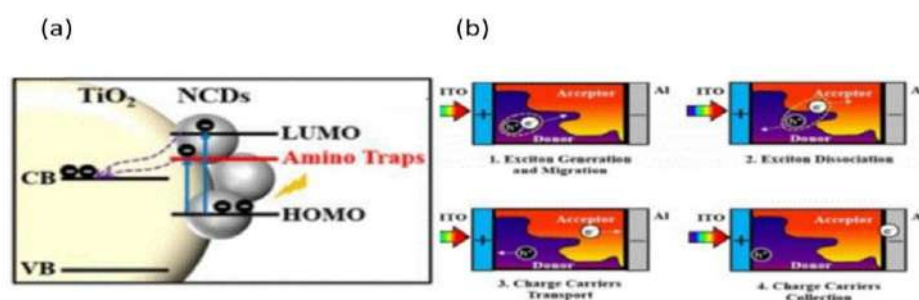
The injected CD patches were easily identifiable (red) from the tissue's autofluorescence (green), Li et al.'s ex-vivo studies on various organs of mice revealed that blue fluorescent CDs could clearly scan the heart, lung, liver, spleen, kidney, intestines, and head, indicating that the CDs could penetrate the blood-brain barrier [198]. At last we can say that CDs are a potent alternative to fluorescent research for in vivo imaging and biological monitoring.

### (3) C Dots Show Photocatalytic Activity

As we know that photocatalysis is an eco-friendly approach for initiating reactions, producing energy, and reducing pollutants, CDs may also be used in this field in one or two ways [199]. The first uses pure and CDs with binding sites and dopants to build extra energy bands for improved photocatalytic performance, whereas the second one incorporates CD-based blends with pre-existing photocatalysts for effective charge separation [199–201]. Based on this output, the CDs in photocatalysis may be split into four key reaction zones: the very first zone is where C dot composite materials were originally used as photocatalysts for the breakdown of organic contaminants, such as organic dyes, Rhodamine B [202] and Methylene Blue [203,204]; for example, Ethyl paraoxon insecticide, gas-phase benzene, and methanol have also been dissolved using CD/Cu<sub>2</sub>O, CD/Fe<sub>2</sub>O<sub>3</sub>, and CD/ZnO compounds [205,206,207]. Next, CDs act as photosensitizers, having a higher apparent absorption in H<sub>2</sub> and O<sub>2</sub> evolution processes via water splitting [208,209]. In CO<sub>2</sub> processing methods, CDs covering the electrodes in optical cells are light illuminated to reduce CO<sub>2</sub> content into CO, organic acids, methane and other hydrocarbons [199,210,21]. Furthermore, considering the positive effect of CO<sub>2</sub> adsorption on greenhouse gas emissions, CD-based approaches will be a high-focus issue for large-scale CO<sub>2</sub> reduction models that are yet to be explored. CDs have been used in a wide range of photocatalytic chemical processes, including selective oxidation and acidic catalysis, whereas their surface area, absorption capacity and/or surface functionality have favoured reactions. Future research should concentrate on large-scale manufacturing, industrial applications and restoration.

### (4) Cd's Photovoltaic Behavior

Another important application of C dots is that they are used in photovoltaic devices because of their high optical absorption over the whole visible spectrum, customizable bandgap and flexibility to serve as an electron donor/acceptor or a carrying medium for electron transport. CDs are a viable choice for a variety of photovoltaic systems as dopants for photosensitive materials, buffer solutions, and counter electrodes [214], due to their low cost and ease of production [215]. In a DSSC solar cell, incoming light is absorbed by the dye, which causes excited electrons to be injected into the conduction band of the TiO<sub>2</sub> electrode [214,215], as Wang and associates employed nitrogen-loaded CDs in the dye solution [216] (this nitrogen enrichment, as seen in Figure 19a), resulting in additional energy bands between carbon and oxygen, which are responsible for capturing low-energy photons. As a result, extra photoinduced electrons can travel to the titanium dioxide (TiO<sub>2</sub>) conduction band, resulting in a higher current density. Furthermore, CDs are high in carboxyl groups, which may chemisorb into the TiO<sub>2</sub> surface, forming a covalent bond and allowing electrons to flow effectively to TiO<sub>2</sub> [214]. Another common configuration is bulk heterojunction organic solar cells (BHJ-OSC), which include donor and acceptor active layers, as shown in Figure 19b [217]. Excitons are then delivered to the donor-acceptor junction, where separated electrons and holes are transmitted to the terminals without coupling, as CDs' electron donating and accepting capabilities are critical for the effective design of these types of devices. CDs have also been used in other solar cell designs, for example, Briscoe and others used biomass-derived CDs in solid-state DSSC [218], in which the difficulties of traditional DSSC (liquid electrolyte leakage, corrosion) may be mitigated by employing a solid electrolyte medium. Despite recent advances, it should be noted that the use of CDs in solar cells is still in its early stages, with a number of issues that must be resolved before it becomes sustainable.



**Figure 19:** (a) A proposed framework for photo-induced electron transfer between NCDs and TiO<sub>2</sub> [216,217] and (b) the energy generating steps in a BHJ-OSC cell.

### **(5) CD's Provide Medicine Carrying Facility**

Nanoparticles can be employed as medicine carriers in biomedical applications without obstructing blood pathways if the particle size or clusters of particles are kept under 4  $\mu\text{m}$ , which is the smallest width of human blood capillaries [219]. Furthermore, the CDs' super biocompatibility which results in minimal cytotoxicity, large surface activity and increased cellular absorption has made them an effective nanomaterial for theragnostic therapy, involving medication and gene delivery [220]. The surface of CDs is loaded with oxygen and nitrogen functional groups (e.g.,  $\text{NH}_2$ ,  $\text{OH}$ ,  $\text{COOH}$ , etc.) that serve as a foundation for transporting medicinal moieties via ionic interactions or covalent bonding [220]. As Kong and colleagues established a citric acid ethylenediamine based carbon dot via a hydrothermal method and tested on a female breast cancer cell line (MCF7). The CDs were electrostatically coupled with Doxorubicin medication to assess cellular toxicity and pharmacological efficacy. The positive surface charge of CDs allows endocytosis, which improves the drug's cellular absorption [220,221], and has also been utilized in gene therapy to successfully convey therapeutic genes to diseased cells [222]. Yu and his colleagues created CDs utilizing hyaluronic acid via microwave-assisted technique using polyethylenimine (PEI) as a passivating agent; they showed lower cytotoxicity and greater transfection effectiveness than PEI in HeLa cells and also increased DNA binding and transfection ability by interconnecting the CDs' carbon core shell topology with a robust amino functionalized surface. Furthermore, CDs' strong fluorescence of CDs allows cellular imaging, which can then be used for surveillance of the DNA loading process. CDs may be used for a variety of purposes in addition to carrying medications or DNA. For example, Wang and others created an integrated nanocomposite with polyethylene glycol, chitosan, and sugar-derived CDs that penetrated intercellular sections to illuminate tumor cells, detect pH changes, enhance pH-sensitive drug release, and induce drug release via outer NIR visible exposure [223]. The multimodal qualities mentioned above improve therapeutic efficacy, while also providing a cutting-edge foundation for CDs in the biomedical sector.

### **(6) C Dots Provide Super Sensitive Foundation of Opto-Electronic Devices**

CDs with properties such as customizable fluorescence, electron providing and/or receiving nature, and high buffering capacity have been used in optoelectronic devices such as OLEDS (LEDs). The broad PL bandgap has also enabled the manufacture of white LEDs, which have been highlighted for their long life, low power dissipation, rapid reaction time, and energy-saving usage [225]. CD-based LEDs are classified as photoluminescent (PL) or electroluminescent (EL), depending on the method of excitation, as PL-based LEDs are fluorescent CD dust on a microchip that has been photoexcited with ultraviolet light and emits visible light [224,225]. The primary disadvantage of such a preparation is aggregation-stimulated quenching (AIQ), which is associated with increased resonance energy transfer or direct coupling and significantly reduces the QY [226,227], CDs are inserted into solid-state matrices such as borax, polyvinyl alcohol (PVA), inorganic salts, silicone, and starch to prevent undesired dampening [225,226]. Furthermore, making matrix-based LEDs with CDs is a time-consuming and energy-intensive process. So Researchers have recently examined production of CDs with different surfaces to control interatomic separation, while Liu and colleagues, used PVA and ethylenediamine to make nitrogen-modified CDs that emit yellow-green light in the solid state and blue light in the liquid state [227]. Rogach and others produced a similar multilayered system from a comparable-sized CD emissive layer that can emit multiple colors, including blue, indigo, pink, and white, by modifying the multilayered properties and applying a voltage. Despite the improvements made in CD-based LED devices, further research is needed to compare them to well-developed heavy-metal-based LEDs, such as generating highly efficient CDs and increasing multilayer properties for better charge exchange.

### **Instrumental Characterization of C Dots**

Instrumental characterization is an important step in determining the morphology and characteristics of the Carbon Dots. The surface conditions of CDs were characterized by a Bruker Tensor 27 FTIR spectrophotometer and elemental mapping is done by JEOL JSM 7200F field emission scanning electron microscopy (FE-SEM). The Raman pattern was created by HORIBA XploRA PLUS Raman Microscope, X-ray photoelectron spectroscopy measurements were taken with a Kratos Analytical AXIS Supra photoelectron and all fluorescence spectrum measurements were taken by Agilent Cary Eclipse Fluorescence Spectrophotometer. Time resolved fluorescence spectroscopy was done using a Horiba fluorolog-3 spectrofluorometer fitted with a 360nm NanoLED and fluorescence decay data is evaluated using DAS-6 Horiba software. The Rare Jupiter Simultaneous Thermal Analyzer was used to do Thermogravimetric measurements (NETZSCH STA 449 F3).

### **The Tauc Method for Determining Optical Absorption or (Bandgap Energy)**

UV-Vis absorbance spectroscopy is one of the most commonly used methods for determining the properties of thin films. Interception produces a bandgap hence, the matching exponent characterizes the electrical transition

via (indirect or direct) (see Tauc & associates, Physica Status Solidi, 1966 as they are commonly referred to as "Tauc" plots). Although the procedure is straightforward and successful, the precision of the fitted bandgap result is rarely emphasized or appreciated. Researchers have put this idea into practice by combining a large number of Tauc charts from the study and comparing them with pure zinc oxide (ZnO), which has been carefully studied and has no intrinsic stoichiometric abnormalities [230]. Our investigation of the energy band values and their variance led us to investigate certain experimental components that might bias the results, resulting in clear values that were less or larger than predicted. Ultimately, a simple approximated figure of merit is defined, which may also assist in the plotting of more precise Tauc matches. This produces an  $E_g$  (ZnO) of  $3.276 \pm 0.033$  eV for specimens with much sharper Tauc plot shapes, which is in perfect agreement with measurements for single-crystalline elements [231]. While investigating the optoelectronic properties of amorphous germanium, Tauc and associates demonstrated and described the estimation of the bandgap using optical absorbance data translated appropriately to energies. Furthermore, Davis and Mott's research on amorphous semiconductors took this concept one step forward by explaining that the intensity of the absorption spectrum is influenced by fluctuations in incoming radiation and the band gap;

$$(\alpha h\nu)^{1/n} = C*(h\nu - E_g).$$

Here "h" represents Planck's value, "v" represents the photon's frequency, "α" is the absorption coefficient,  $E_g$  represents the band-gap and C represents a scaling constant. Where (n) is the value of the exponent which specifies whether electronic transitions are permitted or prohibited as well direct or indirect.

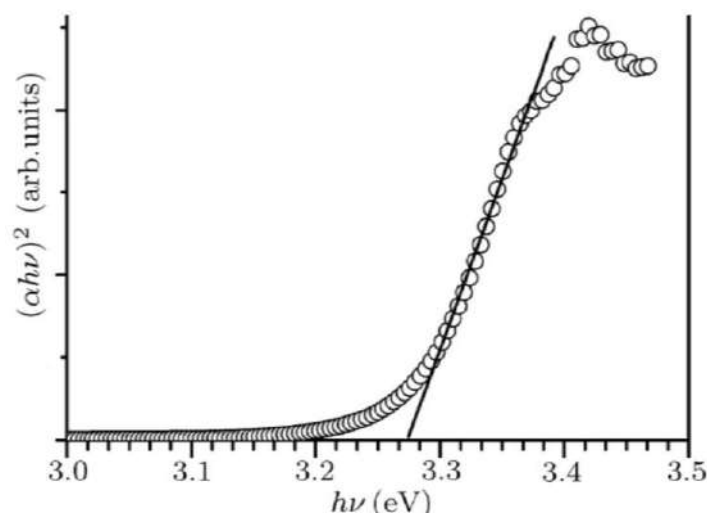
**n=1/2 ---for direct allowed transitions**

**n=3/2 ---for direct forbidden transitions**

**n=2 ---for indirect allowed transitions**

**n=3 ---for indirect forbidden transitions**

In general, permitted transitions exceed typical absorption processes, with  $n=1/2$  or  $n=2$  for direct and indirect shifts, respectively. The basic technique for Tauc research is to collect optical absorbance values for the substance ranging from just below the band gap to above it and then construct the plot  $(\alpha * h * \nu)^{1/n}$  vs  $(h * \nu)$  by testing  $n=1/2$  or  $n=2$  to see which one has the best fit and so recognizes the proper transition type. In the below mentioned Tauc figure for ZnO, the absorption coefficient multiplied by the photon energy to the second power versus incident photon energy are clearly shown, because zinc oxide has allowed transition, ( $n=1/2$ ).



Plot 1: The following figure is demonstrations of a Tauc Plot using UV-Vis data analysis of Zinc oxide thin film, demonstrating the technique of fitting the linear area to derive the band-gap at the X-axis intercept [230,231].

In this squared-exponent plot 1, the absorption increases further, presenting a region of uniformity as it approaches the band gap value. The absorbance falls to zero at low excitation energy, making the solid or liquid composite look transparent and the linear segment was used to extrapolate to the X-axis interception in order to calculate the band gap value (here about 3.27 eV). The absorption constant saturates at higher energy states and the pattern moves away from linearity once again, the reasons for these lower and upper variations from linear behaviour are necessary for selecting and justifying a linear zone for computation. The defective absorption states at the band edge are related to the divergence from linearity at the lower energy end. Urbach investigated this fundamental approach, resulting in the identification of an "Urbach Tail." The absorption behaviour in the

sample Tauc plot can be simply described by an exponential function, which corresponds to a homogeneous density of states [230,231], as shown above in plot (1).

### Quantum Yield (Qy) Measurement

The quantum yield (QY) is a significant property, and measuring it is an important aspect of characterization. The number of photons absorbed and the number of photons emitted per unit of time are the only two factors that must be known according to the QY's formulation. Unfortunately, precise measurements of such values are sometimes difficult to find. As a result, we have concentrated on the most basic scenario, which happens exclusively in dilute solutions, by looking at the integrated fluorescence spectrum of the sample and comparing it to the integrated intensity of a validated QY reference system, keeping the excitation wavelength the same or different. These investigations typically use standard (absorption and emission) spectrometers.

The following equation [229] is used to obtain the QY:

$$QY_{CD} = QY_{st} (I_{NCD} \div I_{st}) (A_{st} \div A_{NCD}) (H_{nCD} \div H_{st})^2.$$

Where  $QY_{st}$  and  $QY_{NCD}$  are the sample's and reference's photoluminescence QY and the subscripts "NCD" and "st" stand for NCDs and reference standard. "I" denotes integrated photoluminescence (PL) intensity, whereas "A" denotes an absorbance measured at an excited wavelength and " $\eta$ " simply denotes the refractive index. To avoid re-absorption effects in the 10 mm fluorescent cuvette, the absorbency must be kept below 0.1 and the excitation wavelength for the sample and the reference might be different in the general case, but this is not recommended because it adds uncertainty to the relative photon flux at the two wavelengths. Although this technique appears to be basic and clear, it has significant and frequently overlooked causes of errors that have not been addressed here.

**Table 5:** The chart displays published results for well-known photoluminescence QY standards.

Emission <sup>a</sup>	Excitation <sup>b</sup>	Solvent/ medium	$\lambda_{exc}$ <sup>c</sup>	Value	Ref.	Year	Comment
<b>Quinine sulfate</b>							
380–580 (451)	280–380 (347)	H <sub>2</sub> SO <sub>4</sub> , 0.5 M	366	0.546	[8–10]	1961	25 °C; value is corrected for self-quenching
		H <sub>2</sub> SO <sub>4</sub> , 0.05 M	366	0.53 ± 0.02	[11]	1977	Optoacoustic; chloride quenching demonstrated
		H <sub>2</sub> SO <sub>4</sub> , 0.05 M	350	0.52 ± 0.02	[12]	2009	Integrating sphere; 5 × 10 <sup>-3</sup> M
		H <sub>2</sub> SO <sub>4</sub> , 0.05 M	350	0.60 ± 0.02	[12]	2009	Integrating sphere; 10 <sup>-5</sup> M
		H <sub>2</sub> SO <sub>4</sub> , 0.05 M		0.52 ± 0.02	[10]	1983	Relative to QS in H <sub>2</sub> SO <sub>4</sub> , 0.5 M
		H <sub>2</sub> SO <sub>4</sub> , 0.05 M		0.51 ± 0.02	[13]	2004	25 °C; Comparative measurement to NIST SRM 936 (next entry)
		HClO <sub>4</sub> , 0.1 M	347.5	0.60 ± 0.02	[14]	1980	NIST SRM 936

### CONCLUSION

In both the natural and living environments, biomass is plentiful and widely available. In this study, I described the basic morphology of carbon dots, the production of fluorescent C-dots from biomass, the key factors that impact the fluorescence intensity of C-dots, and the characteristics and applications of C-dots created from biomass sources. The benefits of synthesizing C-dots from biomass precursors over chemical agents include the simple availability of a carbon source, ease of manufacture and feasibility of large-scale production owing to the presence of carbonaceous materials in the biomass precursors. Some C-dots derived from biomass sources are self-passivated in the synthesis process, allowing carbonization and surface passivation to happen at the same time, while heteroatom-containing compounds found in biomass waste can operate as surface passivation agents. Finally, we conclude that C-dots generated from biomass have a high fluorescence quantum yield, excellent photostability, high photocatalytic activity, low cytotoxicity, and excellent biocompatibility, making them suitable for a variety of applications, such as drug administration, ion sensing, bioimaging and photocatalysis.

### Need For Further Research on C Dots

Several research gaps have been found and described based on previous studies:

- (1) In the realm of functional carbon nanomaterials, carbon dots are a novel and distinctive structure. The synthesis of CDs from biomass is a viable and sustainable method. Some minerals such as oxygen/sulfur/nitrogen functional groups and other elements naturally found in biomass have been anticipated to alter fluorescence. As a result, there is a need to determine the impact of biomass composition on the properties of CDs. Furthermore, CDs are produced via hydrothermal carbonization or microwave digestion of biomass precursors, and despite the simplicity of these methods, the inability to control particle size leads to multistep post-separation treatments. Therefore, size management enhancements should be investigated.
- (2) These biomass precursors may be regarded as a good avenue for novel carbon compounds, despite the fact that cellulose is the most abundant component in biomass and is rich in carbon. Besides to that, low quantum yield is a major problem that has to be addressed. Therefore, new preparation methodologies associated with pre and post treatment procedures and with specific doping agents should be investigated in the future.
- (3) CDs have been employed in a number of fields due to their chemical, physical and optical properties including sensing, imaging, photocatalysis, energy conversion and drug carriers. A more focused strategy can significantly improve the sensing and bioimaging capabilities of biomass-derived CDs. Moreover, the detailed mechanisms of CD's with analytes and cells must be explored in order to improve the sensing efficiency.
- (4) Future research should be conducted on the development of new devices based on metal-oxide carbon dots for the benefit of human life and the environment.

### ACKNOWLEDGEMENTS

I am thankful to my Supervisor Dr. R.S.Chandok and Co-Supervisor Dr. Khan Abida for their assistance, enthusiastic encouragement and useful critiques of this whole research work.

Finally i wish to thank my parents and my brother sheikh arshid for their support and encouragement throughout my study.

### Conflicts of interest

There are no conflicts of interest to declare.

### Data availability statement

Data sharing is not applicable to this article as no new data were created or analyzed in this study.

### Disclosure statement

There are no competing interests to declare.

### Funding Statement

This work received no specific grant from any funding agency in the public, commercial or not-for-profit sectors.

### REFERENCES

1. Xu, X.Y.; Ray, R.; Gu, Y.L.; Ploehn, H.J.; Gearheart, L.; Raker, K.; Scrivens, W.A. Electrophoretic analysis and purification of fluorescent single-walled carbon nanotube fragments. *J. Am. Chem. Soc.* **2004**, *126*, 12736–12737.
2. Sun, Y.P.; Bing, Z.; Yi, L.; Wei, W.; Fernando, K.A.S.; Pathak, P.; Mezziani, M.J.; Harruff, B.A.; Xin, W.; Wang, H. Quantum-sized carbon dots for bright and colorful photoluminescence. *J. Am. Chem. Soc.* **2006**, *128*, 7756–7757.
3. Zhang, M.R.; Su, R.; Zhong, J.; Fei, L.; Cai, W.; Guan, Q.W.; Li, W.J.; Li, N.; Chen, Y.S.; Cai, L.L. Red/orange dual-emissive carbon dots for pH sensing and cell imaging. *Nano Res.* **2019**, *12*, 815–821.
4. Zhang, Y.N.; Zhang, X.W.; Shi, Y.P.; Sun, C.; Zhou, N.; Wen, H.X. The synthesis and functional study of multicolor nitrogen-doped carbon dots for live cell nuclear imaging. *Molecules* **2020**, *25*, 306.
5. Liu, J.J.; Dong, Y.Y.; Ma, Y.X.; Han, Y.X.; Ma, S.; Chen, H.L.; Chen, X.G. One-step synthesis of red/green dual-emissive carbon dots for ratiometric sensitive ONOO<sup>-</sup> probing and cell imaging. *Nanoscale* **2018**, *10*, 13589–13598.

6. Qin, K.H.; Zhang, D.F.; Ding, Y.F.; Zheng, X.D.; Xiang, Y.Y.; Hua, J.H.; Zhang, Q.; Ji, X.L.; Li, B.; Wei, Y.L. Applications of hydrothermal synthesis of Escherichia coli derived carbon dots in in vitro and in vivo imaging and p-nitrophenol detection. *Analyst* **2020**, 145, 177–183.
7. Liu, J.J.; Li, D.W.; Zhang, K.; Yang, M.X.; Sun, H.C.; Yang, B. One step hydrothermal synthesis of nitrogen-doped conjugated carbonized polymer dots with 31% efficient red emission for In Vivo imaging. *Small* **2018**, 14, 1703919–1703929.
8. Shu, Y.; Lu, J.; Mao, Q.X.; Song, R.S.; Wang, X.Y.; Chen, X.W.; Wang, J.H. Ionic liquid mediated organophilic carbon dots for drug delivery and bioimaging. *Carbon* **2017**, 114, 324–333.
9. Kailasa, S.K.; Bhamore, J.R.; Koduru, J.R.; Park, T.J. Carbon dots as carriers for the development of controlled drug and gene delivery systems. In *Biomedical Applications of Nanoparticles*; Grumezescu, A.M., Ed.; Elsevier: Amsterdam, The Netherlands, 2019; pp. 295–317.
10. Yang, T.; Huang, J.L.; Wang, Y.T.; Zheng, A.Q.; Shu, Y.; Wang, J.H.  $\beta$ -cyclodextrin-decorated carbon dots serve as nanocarriers for targeted drug delivery and controlled release. *ChemNanoMat* **2019**, 5, 479–487.
11. Jana, J.; Lee, H.J.; Chung, J.S.; Kim, M.H.; Hur, S.H. Blue emitting nitrogen-doped carbon dots as a fluorescent probe for nitrite ion sensing and cell-imaging. *Anal. Chim. Acta* **2019**, 1079, 212–219.
12. Wang, J.; Li, R.S.; Zhang, H.Z.; Wang, N.; Zhang, Z.; Huang, C.Z. Highly fluorescent carbon dots as selective and visual probes for sensing copper ions in living cells via an electron transfer process. *Biosens. Bioelectron.* **2017**, 97, 157–163.
13. Hu, J.; Tang, F.; Jiang, Y.; Liu, C. Rapid screening and quantitative detection of Salmonella using a quantum dot nanobead-based biosensor. *Analyst* **2020**, 145, 2184–2190.
14. Han, M.; Zhu, S.J.; Lu, S.; Song, Y.B.; Feng, T.L.; Tao, S.Y.; Liu, J.J.; Yang, B. Recent progress on the photocatalysis of carbon dots: Classification, mechanism and applications. *Nano Today* **2018**, 19, 201–218.
15. Yu, H.J.; Shi, R.; Zhao, Y.F.; Waterhouse, G.I.; Wu, L.Z.; Tung, C.H.; Zhang, T.R. Smart utilization of carbon dots in semiconductor photocatalysis. *Adv. Mater.* **2016**, 28, 9454–9477.
16. Zhou, Y.; Zahran, E.M.; Quiroga, B.A.; Perez, J.; Mintz, K.J.; Peng, Z.; Liyanage, P.Y.; Pandey, R.R.; Chusuei, C.C.; Leblanc, R.M. Size-dependent photocatalytic activity of carbon dots with surface-state determined photoluminescence. *Appl. Catal. B* **2019**, 248, 157–166.
17. Yuan, F.L.; Yuan, T.; Sui, L.Z.; Wang, Z.B.; Xi, Z.; Li, Y.C.; Li, X.H.; Fan, L.Z.; Tan, Z.A.; Chen, A.; et al. Engineering triangular carbon quantum dots with unprecedented narrow bandwidth emission for multicolored LEDs. *Nat. Commun.* **2018**, 9, 2249–2260.
18. Zheng, J.X.; Liu, X.H.; Yang, Y.Z.; Liu, X.G.; Xu, B.S. Rapid and green synthesis of fluorescent carbon dots from starch for white light-emitting diodes. *New Carbon Mater.* **2018**, 33, 276–288.
19. Hu, C.; Li, M.Y.; Qiu, J.S.; Sun, Y.P. Design and fabrication of carbon dots for energy conversion and storage. *Chem. Soc. Rev.* **2019**, 48, 2315–2337.
20. Fernando, K.S.; Sahu, S.; Liu, Y.; Lewis, W.K.; Gulians, E.A.; Jafariyan, A.; Wang, P.; Bunker, C.E.; Sun, Y.P. Carbon quantum dots and applications in photocatalytic energy conversion. *ACS Appl. Mater. Interfaces* **2015**, 7, 8363–8376.
21. Genc, R.; Alas, M.O.; Harputlu, E.; Repp, S.; Kremer, N.; Castellano, M.; Colak, S.G.; Ocakoglu, K.; Erdem, E. High-capacitance hybrid supercapacitor based on multi-colored fluorescent carbon-dots. *Sci. Rep.* **2017**, 7, 11222.
22. Joseph, J.L.; Anappara, A.A. White light emitting carbon dots prepared by the electrochemical exfoliation of graphite. *ChemPhysChem* **2017**, 18, 292–298.
23. Liu, M.L.; Xu, Y.H.; Niu, F.S.; Gooding, J.J.; Liu, J.Q. Carbon quantum dots directly generated from electrochemical oxidation of graphite electrodes in alkaline alcohols and the applications for specific ferric ion detection and cell imaging. *Analyst* **2016**, 141, 2657–2664.

24. Hou, Y.X.; Lu, Q.J.; Deng, J.H.; Li, H.T.; Zhang, Y.Y. One-pot electrochemical synthesis of functionalized fluorescent carbon dots and their selective sensing for mercury ion. *Anal. Chim. Acta* **2015**, 866, 69–74.
25. Dey, S.; Govindaraj, A.; Biswas, K.; Rao, C.N.R. Luminescence properties of boron and nitrogen doped graphene quantum dots prepared from arc-discharge-generated doped graphene samples. *Chem. Phys. Lett.* **2014**, 595–596, 203–208.
26. Si, J.H.; Yan, L.H.; Nguyen, V.; Hou, X. Femtosecond laser-assisted synthesis of highly photoluminescent carbon nanodots for Fe<sup>3+</sup> detection with high sensitivity and selectivity. *Opt. Mater. Express* **2016**, 6, 312–320.
27. Nguyen, V.; Zhao, N.; Yan, L.; Zhong, P.; Le, P.H. Double-pulse femtosecond laser ablation for synthesis of ultrasmall carbon nanodots. *Mater. Res. Express* **2020**, 7, 015606–015612.
28. Xu, H.H.; Yan, L.; Nguyen, V.; Yu, Y.; Xu, Y.M. One-step synthesis of nitrogen-doped carbon nanodots for ratiometric pH sensing by femtosecond laser ablation method. *Appl. Surf. Sci.* **2017**, 414, 238–243.
29. Li, X.; Chai, C.; Zhang, Y.; Wang, Y.; Choi, M.M.F. Microwave synthesis of nitrogen and sulfur co-doped carbon dots for the selective detection of Hg<sup>2+</sup> and glutathione. *Opt. Mater.* **2020**, 99, 109559–109567.
30. Tabaraki, R.; Abdi, O. Microwave assisted synthesis of N-doped carbon dots: Aneasy, fast and cheap sensor for determination of aspartic acid in sport supplements. *J. Fluoresc.* **2019**, 29, 751–756.
31. Deng, Z.Q.; Liu, C.; Jin, Y.Z.; Pu, J.L.; Wang, B.; Chen, J.C. High quantum yield blue- and orange-emitting carbon dots: One-step microwave synthesis and applications as fluorescent films and in fingerprint and cellular imaging. *Analyst* **2019**, 144, 4569–4574.
32. Qin, J.; Zhang, L.M.; Yang, R. Solid pyrolysis synthesis of excitation-independent emission carbon dots and its application to isoniazid detection. *J. Nanopart. Res.* **2019**, 21, 59–70.
33. Tian, M.; Wang, Y.T.; Zhang, Y. Synthesis of fluorescent nitrogen-doped carbon quantum dots for selective detection of picric acid in water samples. *J. Nanosci. Nanotechnol.* **2018**, 18, 8111–8117.
34. Hu, Y.W.; Wang, Y.X.; Wang, C.T.; Ye, Y.W.; Xue, Q.J. One-pot pyrolysis preparation of carbon dots as eco-friendly nanoadditives of water-based lubricants. *Carbon* **2019**, 152, 511–520.
35. Lu, J.Y.; Su, L.B.; Feng, G.; Jiang, J.T.; Hong, G.R.S.; Sun, Z.M.; Li, L.L. Potential application of nitrogen-doped carbon quantum dots synthesized by a solvothermal method for detecting silver Ions in food packaging. *Int. J. Environ. Res. Public Health* **2019**, 16, 2518.
36. Lin, L.P.; Wang, Y.H.; Xiao, Y.L.; Liu, W. Hydrothermal synthesis of carbon dots codoped with nitrogen and phosphorus as a turn-on fluorescent probe for cadmium(II). *Microchim. Acta* **2019**, 186, 147.
37. Xu, D.D.; Lei, F.; Chen, H.H.; Yin, L.Q.; Shi, Y.; Xie, J.J. One step hydrothermal synthesis and optical properties of self-quenching-resistant carbon dots towards fluorescent ink and as nanosensors for Fe<sup>3+</sup> detection. *RSC Adv.* **2019**, 9, 8290–8299.
38. Liu, H.; Zhang, H.W.; Li, J.Y.; Tang, Y.Y.; Cao, Y.; Jiang, Y. Organic-inorganic hybrid carbon dots for cell imaging. *Mater. Res. Express* **2018**, 5, 045009–045015.
39. Rong, M.C.; Yang, X.H.; Huang, L.Z.; Chi, S.T.; Zhou, Y.B. Hydrogen peroxide-assisted ultrasonic synthesis of BCNO QDs for the anthrax biomarker detection. *ACS Appl. Mater. Interfaces* **2018**, 11, 2336–2343.
40. Huang, H.Y.; Cui, Y.; Liu, M.Y.; Chen, J.Y.; Wan, Q.; Wen, Y.Q.; Deng, F.J.; Zhou, N.G.; Zhang, X.Y.; Wei, Y. A one-step ultrasonic irradiation assisted strategy for the preparation of polymer-functionalized carbon quantum dots and their biological imaging. *J. Colloid Interface Sci.* **2018**, 532, 767–773.
41. Qiao, Z.A.; Wang, Y.F.; Gao, Y.; Li, H.W.; Dai, T.Y.; Liu, Y.L.; Huo, Q.S. Commercially activated carbon as the source for producing multicolor photoluminescent carbon dots by chemical oxidation. *Chem. Commun.* **2010**, 46, 8812–8814.
42. Zheng, H.; Wang, Q.; Long, Y.; Zhang, H.; Huang, X.; Zhu, R. Enhancing the luminescence of carbon dots with a reduction pathway. *Chem. Commun.* **2011**, 47, 10650–10652.



43. Liu, H.; Li, Z.; Sun, Y.; Geng, X.; Hu, Y.; Meng, H.; Ge, J.; Qu, L. Synthesis of luminescent carbon dots with ultrahigh quantum yield and inherent folate receptor-positive cancer cell targetability. *Sci. Rep.* **2018**, *8*, 1086.
44. Yarur, F.; Macairan, J.R.; Naccache, R. Ratiometric detection of heavy metal ions using fluorescent carbon dots. *Environ. Sci.* **2019**, *6*, 1121–1130.
45. Sukhorukov, G., I. Goryacheva, and A. Sapelkin, Carbon nanodots: mechanisms of photoluminescence and principles of application. *Review. Trends in Analytical Chemistry*, 2017.
46. Sun, X. and Y. Lei, Fluorescent carbon dots and their sensing applications. *TrAC Trends in Analytical Chemistry*, 2017. *89*: p. 163-180.
47. Zhang, J. and S.-H. Yu, Carbon dots: large-scale synthesis, sensing and bioimaging. *Materials Today*, 2016. *19*(7): p. 382-393.
48. Sciortino, A., A. Cannizzo, and F. Messina, Carbon Nanodots: A Review—From the Current Understanding of the Fundamental Photophysics to the Full Control of the Optical Response. *C*, 2018. *4*(4): p. 67.
49. Basu, N. and D. Mandal, Time-resolved photoluminescence of pH-sensitive carbon dots. *Carbon*, 2019. *144*: p. 500-508.
50. Yuan, F., et al., Shining carbon dots: synthesis and biomedical and optoelectronic applications. *Nano Today*, 2016. *11*(5): p. 565-586.
51. Namdari, P., B. Negahdari, and A. Eatemadi, Synthesis, properties and biomedical applications of carbon-based quantum dots: An updated review. *Biomedicine & Pharmacotherapy*, 2017. *87*: p. 209-222.
52. Basu, N. and D. Mandal, Solvatochromic Response of Carbon Dots: Evidence of Solvent Interaction with Different Types of Emission Centers. *The Journal of Physical Chemistry C*, 2018. *122*(32): p. 18732-18741.
53. Gharat, P.M., et al., An insight into the molecular and surface state photoluminescence of carbon dots revealed through solvent-induced modulations in their excitation wavelength dependent emission properties. *Photochemical & Photobiological Sciences*, 2019. *18*(1): p. 110-119.
54. Shen, L.-M. and J. Liu, New development in carbon quantum dots technical applications. *Talanta*, 2016. *156*: p. 245-256.
55. Thiyagarajan, S.K., et al., Fluorescent carbon nano dots from lignite: unveiling the impeccable evidence for quantum confinement. *Physical Chemistry Chemical Physics*, 2016. *18*(17): p. 12065-12073.
56. Gan, Z., H. Xu, and Y. Hao, Mechanism for excitation-dependent photoluminescence from graphene quantum dots and other graphene oxide derivatives: consensus debates and challenges. *Nanoscale*, 2016. *8*(15): p. 7794-7807.
57. E. Roduner, *Nanosopic Materials: Size-Dependent Phenomena*. The Royal Society of Chemistry, Cambridge, 2006.
58. J. Jortner, *Z. Phys. D: At., Mol. Clusters*, 1992, *24*, 247.
59. A. Köhn, F. Weigend and R. Ahlrichs, *Phys. Chem. Chem. Phys.*, 2001, *3*, 711.
60. Murray CB, Norris DJ, Bawendi MG. Synthesis and characterization of nearly monodisperse CdE (E = sulfur, selenium, tellurium) semiconductor nanocrystallites. *Journal of American Chemical Society*. 1993; **115**:8706-8715
61. Brus LE. Electron-electron and electron-hole interactions in small semiconductor. Crystallites: The size dependence of the lowest excited electronic state. *The Journal of Chemical Physics*. 1984; **80**:4403. DOI: 10.1063/1.447218
62. Nozik AJ, Williams F, Nenadovic MT, Rajh T, Micic OI. Size quantization in small semiconductor particles. *The Journal of Physical Chemistry*. 1985; **89**:397-399. DOI: 10.1021/j100249a004.
63. Gan, Z., H. Xu, and Y. Hao, Mechanism for excitation-dependent photoluminescence from graphene quantum dots and other graphene oxide derivatives: consensus debates and challenges. *Nanoscale*, 2016. *8*(15): p. 7794-7807.

64. Yuan, F., et al., Bright Multicolor Bandgap Fluorescent Carbon Quantum Dots for Electroluminescent Light-Emitting Diodes. *Advanced materials*, 2017. 29(3): p. 1604436.
65. Li, H., et al., Water-soluble fluorescent carbon quantum dots and photocatalyst design. *Angewandte Chemie International Edition*, 2010. 49(26): p. 4430-4434.
66. Ortega-Liebana, M., et al., Uniform luminescent carbon nanodots prepared by rapid pyrolysis of organic precursors confined within nanoporous templating structures. *Carbon*, 2017. 117: p. 437-446.
67. Sun, X., et al., Nano-graphene oxide for cellular imaging and drug delivery. *Nano research*, 2008. 1(3): p. 203-212.
68. Park, Y., et al., Improving the functionality of carbon nanodots: doping and surface functionalization. *Journal of Materials Chemistry A*, 2016. 4(30): p. 11582-11603.
69. Liu, Z., et al., Photoluminescence of carbon quantum dots: coarsely adjusted by quantum confinement effects and finely by surface trap states. *Science China Chemistry*, 2018. 61(4): p. 490-496.
70. Guo, X., et al., Facile access to versatile fluorescent carbon dots toward light-emitting diodes. *Chemical communications*, 2012. 48(21): p. 2692-2694.
71. Basu, N. and D. Mandal, Time-resolved photoluminescence of pH-sensitive carbon dots. *Carbon*, 2019. 144: p. 500508.
72. Jaffe, H.H. and A.L. Miller, The fates of electronic excitation energy. *Journal of chemical education*, 1966. 43(9): p. 469.
73. Demchenko, A.P. and M.O. Dekaliuk, The origin of emissive states of carbon nanoparticles derived from ensemble-averaged and single-molecular studies. *Nanoscale*, 2016. 8(29): p. 14057-14069.
74. Sun, Z., et al., Origin of green luminescence in carbon quantum dots: specific emission bands originate from oxidized carbon groups. *New Journal of Chemistry*, 2018. 42(6): p. 4603-4611.
75. Ding, H., et al., Full-color light-emitting carbon dots with a surface-state-controlled luminescence mechanism. *ACS nano*, 2015. 10(1): p. 484-491.
76. Sun, D., et al., Hair fiber as a precursor for synthesizing of sulfur-and nitrogen-co-doped carbon dots with tunable luminescence properties. *Carbon*, 2013. 64: p. 424-434.
77. Lim, S.Y., W. Shen, and Z. Gao, Carbon quantum dots and their applications. *Chemical Society Reviews*, 2015. 44(1): p. 362-381.
78. Shamsipur, M., et al., Resolving the Multiple Emission Centers in Carbon Dots: From Fluorophore Molecular States to Aromatic Domain States and Carbon-Core States. *The journal of physical chemistry letters*, 2018. 9(15): p. 4189-4198.
79. Krysmann, M.J., et al., Formation mechanism of carbogenic nanoparticles with dual photoluminescence emission. *Journal of the American Chemical Society*, 2011. 134(2): p. 747-750.
80. Bourlinos, A.B., et al., Surface functionalized carbogenic quantum dots. *small*, 2008. 4(4): p. 455-458.
81. Sun, X., et al., Microwave-assisted ultrafast and facile synthesis of fluorescent carbon nanoparticles from a single precursor: preparation, characterization and their application for the highly selective detection of explosive picric acid. *Journal of Materials Chemistry A*, 2016. 4(11): p. 4161-4171.
82. Koupaie, E.H.; Dahadha, S.; Lakeh, A.A.B.; Azizi, A.; Elbeshbishy, E. Enzymatic pretreatment of lignocellulosic biomass for enhanced biomethane production-A review. *J. Environ. Manag.* **2019**, 233, 774–784.
83. Tripathi, M.; Sahu, J.N.; Ganesan, P. Effect of process parameters on production of biochar from biomass waste through pyrolysis: A review. *Renew. Sustain. Energy Rev.* **2016**, 55, 467–481.
84. Ghimire, A.; Frunzo, L.; Pontoni, L.; d'Antonio, G.; Lens, P.N.L.; Esposito, G.; Pirozzi, F. Dark fermentation of complex waste biomass for biohydrogen production by pretreated thermophilic anaerobic digestate. *J. Environ. Manag.* **2015**, 152, 43–48.

85. Queiroz, L.S.; de Souza, L.K.C.; Thomaz, K.T.C.; Leite-Lima, E.T.; da Rocha-Filho, G.N.; do Nascimento, L.A.S.; de Oliveira-Pires, L.H.; Faial, K.d.C.F.; da Costa, C.E.F. Activated carbon obtained from amazonian biomass tailings (acai seed): Modification, characterization, and use for removal of metal ions from water. *J. Environ. Manag.* **2020**, 270, 110868–110876.
86. H. Zhang, D. Yee, and C. Wang, Quantum dots for cancer diagnosis and therapy: Biological and clinical perspectives. *Nanomed.* 3, 83 (2008).
87. Roy, P., et al., Photoluminescent carbon nanodots: synthesis, physicochemical properties and analytical applications. *Materials Today*, 2015. 18(8): p. 447-458.
88. De, B. and N. Karak, Recent progress in carbon dot–metal based nanohybrids for photochemical and electrochemical applications. *Journal of Materials Chemistry A*, 2017. 5(5): p. 1826-1859.
89. Tetsuka, H., et al., Optically tunable amino-functionalized graphene quantum dots. *Advanced Materials*, 2012. 24(39): p. 5333-5338
90. Liu, Q., et al., Strong two-photon-induced fluorescence from photostable, biocompatible nitrogen-doped graphene quantum dots for cellular and deep-tissue imaging. *Nano letters*, 2013. 13(6): p. 2436-2441.
91. Liu, F., et al., Facile synthetic method for pristine graphene quantum dots and graphene oxide quantum dots: origin of blue and green luminescence. *Advanced materials*, 2013. 25(27): p. 3657-3662.
92. Lee, J., et al., Uniform graphene quantum dots patterned from self-assembled silica nanodots. *Nano letters*, 2012. 12(12): p. 6078-6083.
93. Zhou, X., et al., Photo-Fenton reaction of graphene oxide: a new strategy to prepare graphene quantum dots for DNA cleavage. *ACS nano*, 2012. 6(8): p. 6592-6599.
94. Mittal, J. and N. Kushwaha, Over-oxidation of multi-walled carbon nanotubes and formation of fluorescent carbon nanoparticles. *Materials Letters*, 2015. 145: p. 37-40.
95. Mao, X.-J., et al., Study on the fluorescence characteristics of carbon dots. *Spectrochimica Acta Part A: Molecular and Biomolecular Spectroscopy*, 2010. 75(2): p. 553-557.
96. Cao, L., et al., Competitive performance of carbon “quantum” dots in optical bioimaging. *Theranostics*, 2012. 2(3): p. 295.
97. Dong, Y., et al., One-step and high yield simultaneous preparation of single-and multi-layer graphene quantum dots from CX-72 carbon black. *Journal of Materials Chemistry*, 2012. 22(18): p. 8764-8766.
98. Thongpool, V., P. Asanithi, and P. Limsuwan, Synthesis of carbon particles using laser ablation in ethanol. *Procedia Engineering*, 2012. 32: p. 1054-1060.
99. Nguyen, V., L. Yan, and J. Si. Synthesis of broad photoluminescence carbon nanodots by femtosecond laser ablation in liquid. in 2016 IEEE 16th International Conference on Nanotechnology (IEEE-NANO). 2016. IEEE.
100. Hu, S.-L., et al., One-step synthesis of fluorescent carbon nanoparticles by laser irradiation. *Journal of Materials Chemistry*, 2009. 19(4): p. 484-488
101. Li, X., et al., Preparation of carbon quantum dots with tunable photoluminescence by rapid laser passivation in ordinary organic solvents. *Chemical Communications*, 2010. 47(3): p. 932-934.
102. Liu, M., et al., Carbon quantum dots directly generated from electrochemical oxidation of graphite electrodes in alkaline alcohols and the applications for specific ferric ion detection and cell imaging. *Analyst*, 2016. 141(9): p. 2657-2664.
103. Niu, F., et al., Electrochemically generated green-fluorescent N-doped carbon quantum dots for facile monitoring alkaline phosphatase activity based on the Fe<sup>3+</sup>-mediating ON-OFF-ON-OFF fluorescence principle. *Carbon*, 2018. 127: p. 340-348.
104. Arora, N. and N. Sharma, Arc discharge synthesis of carbon nanotubes: Comprehensive review. *Diamond and related materials*, 2014. 50: p. 135-150.
105. Liang, F., et al., Selective preparation of polyhedral graphite particles and multi-wall carbon nanotubes by a transferred arc under atmospheric pressure. *Diamond and Related Materials*, 2012. 30: p. 70-76.

106. Xu, X., et al., Electrophoretic analysis and purification of fluorescent single-walled carbon nanotube fragments. *Journal of the American Chemical Society*, 2004. 126(40): p. 12736-12737.
107. Wang, Y., et al., Fluorescent carbon dots: rational synthesis, tunable optical properties and analytical applications. *RSC Advances*, 2017. 7(65): p. 40973-40989.
108. Jhonsi, M.A., Carbon Quantum Dots for Bioimaging, in *State of the Art in Nano-bioimaging*. 2018, IntechOpen.
109. Hu, Q., et al., Characterization and analytical separation of fluorescent carbon nanodots. *Journal of Nanomaterials*, 2017. 2017.
110. Sevilla, M. and A.B. Fuertes, The production of carbon materials by hydrothermal carbonization of cellulose. *Carbon*, 2009. 47(9): p. 2281-2289.
111. Wang, T., et al., A review of the hydrothermal carbonization of biomass wastes for hydrochar formation: Process conditions, fundamentals, and physicochemical properties. *Renewable and Sustainable Energy Reviews*, 2018. 90: p. 223-247.
112. Hoekman, S.K., A. Broch, and C. Robbins, Hydrothermal carbonization (HTC) of lignocellulosic biomass. *Energy & Fuels*, 2011. 25(4): p. 1802-1810.
113. Sahu, S., et al., Simple one-step synthesis of highly luminescent carbon dots from orange juice: application as excellent bio-imaging agents. *Chemical Communications*, 2012. 48(70): p. 8835-8837.
114. Katti, A.K.S. and M. Sharon, Advancements in Various Fabrication Methods of Nanoparticles, in *History of Nanotechnology: From Prehistoric to Modern Times*, M. Sharon, and Editor. 2019.
115. Shen, J., et al., Facile synthesis of fluorescence carbon dots from sweet potato for Fe<sup>3+</sup> sensing and cell imaging. *Materials Science and Engineering: C*, 2017. 76: p. 856-864.
116. Schwenke, A.M., S. Hoepfner, and U.S. Schubert, Synthesis and modification of carbon nanomaterials utilizing microwave heating. *Advanced Materials*, 2015. 27(28): p. 4113-4141.
117. Gaudino, E.C., et al., from waste biomass to chemicals and energy via microwave-assisted processes. *Green Chemistry*, 2019. 21(6): p. 1202-1235.
118. Park, S.Y.; Lee, H.U.; Park, E.S.; Lee, S.C.; Lee, J.W.; Jeong, S.W.; Chi, H.K.; Lee, Y.C.; Yun, S.H.; Lee, J. Photoluminescent Green Carbon Nanodots from Food-Waste-Derived Sources: Large-Scale Synthesis, Properties, and Biomedical Applications. *ACS Appl. Mater. Interfaces* **2014**, 6, 3365–3370.
119. Li, H., et al., One-step ultrasonic synthesis of water-soluble carbon nanoparticles with excellent photoluminescent properties. *Carbon*, 2011. 49(2): p. 605-609.
120. Tan, X.W., et al., Carbon dots production via pyrolysis of sago waste as potential probe for metal ions sensing. *Journal of analytical and applied pyrolysis*, 2014. 105: p. 157-165.
121. Arole, V. and S. Munde, Fabrication of nanomaterials by top-down and bottom-up approaches-an overview. *Journal of Materials Science*, 2014. 1: p. 89-93.
122. Karfa, P., et al., Functionalization of Carbon Nanostructures, in *Comprehensive Nanoscience and Nanotechnology*, D. Andrews, T. Nann, and R.H. Lipson, Editors. 2018.
123. Thakkar, K.N., S.S. Mhatre, and R.Y. Parikh, Biological synthesis of metallic nanoparticles. *Nanomedicine: nanotechnology, biology and medicine*, 2010. 6(2): p. 257-262.
124. Mhetaer, T.; Xu, Y.; Yin, X.B. Review on carbon dots and their applications. *Chin. J. Anal. Chem.* **2017**, 45, 139–150.
125. Zhu, S.; Song, Y.; Zhao, X.; Shao, J.; Zhang, J.; Yang, B. The photoluminescence mechanism in carbon dots (graphene quantum dots, carbon nanodots, and polymer dots): Current state and future perspective. *Nano Res.* **2015**, 8, 355–381.
126. Yan, F.y.; Sun, Z.h.; Zhang, H.; Sun, X.d.; Jiang, Y.x.; Bai, Z.j. The fluorescence mechanism of carbon dots, and methods for tuning their emission color: A review. *Microchim. Acta* **2019**, 186, 583.

127. Hola, K.; Bourlinos, A.B.; Kozak, O.; Berka, K.; Siskova, K.M.; Havrdova, M.; Tucek, J.; Safarova, K.; Otyepka, M.; Giannelis, E.P. Photoluminescence effects of graphitic core size and surface functional groups in carbon dots: COO<sup>-</sup> induced red-shift emission. *Carbon* **2014**, 70, 279–286.
128. Zhang, R.; Liu, Y.B.; Yu, L.; Li, Z.; Sun, S.Q. Preparation of high-quality biocompatible carbon dots by extraction, with new thoughts on the luminescence mechanisms. *Nanotechnology* **2013**, 24, 225601–225610.
129. Suryawanshi, A.; Biswal, M.; Mhamane, D.; Gokhale, R.; Patil, S.; Guin, D.; Ogale, S. Large scale synthesis of graphene quantum dots (GQDs) from waste biomass and their use as an efficient and selective photoluminescence on-off-on probe for Ag(+) ions. *Nanoscale* **2014**, 6, 11664–11670.
130. D'Angelisdo, E.S.; Barbosa, C.; Corrêa, J.R.; Medeiros, G.A.; Barreto, G.; Magalhães, K.G.; de Oliveira, A.L.; Spencer, J.; Rodrigues, M.O.; Neto, B.A.D. Carbon dots (C-dots) from cow manure with impressive subcellular selectivity tuned by simple chemical modification. *Chem.-A Eur. J.* **2015**, 21, 5055–5060.
131. Sarswat, P.K.; Free, M.L. Light emitting diodes based on carbon dots derived from food, beverage, and combustion wastes. *PCCP* **2015**, 17, 27642–27652.
132. Himaja, A.L.; Karthik, P.S.; Sreedhar, B.; Singh, S.P. Synthesis of carbon dots from kitchen waste: Conversion of waste to value added product. *J. Fluoresc.* **2014**, 24, 1767–1773.
133. Boruah, A.; Saikia, M.; Das, T.; Goswamee, R.L.; Saikia, B.K. Blue-emitting fluorescent carbon quantum dots from waste biomass sources and their application in fluoride ion detection in water. *J. Photochem. Photobiol. B Biol.* **2020**, 209, 111940–111952.
134. Zhu, L.L.; Yin, Y.J.; Wang, C.F.; Chen, S. Plant leaf-derived fluorescent carbon dots for sensing, patterning and coding. *J. Mater. Chem. C* **2013**, 1, 4925–4932.
135. Tan, X.W.; Romainor, A.N.B.; Chin, S.F.; Ng, S.M. Carbon dots production via pyrolysis of sago waste as potential probe for metal ions sensing. *J. Anal. Appl. Pyrolysis* **2014**, 105, 157–165.
136. Hu, Y.P.; Yang, J.; Tian, J.W.; Jia, L.; Yu, J.-S. Waste frying oil as a precursor for one-step synthesis of sulfur-doped carbon dots with pH-sensitive photoluminescence. *Carbon* **2014**, 77, 775–782.
137. Devi, P.; Kaur, G.; Thakur, A.; Kaur, N.; Grewal, A.; Kumar, P. Waste derivitized blue luminescent carbon quantum dots for selenite sensing in water. *Talanta* **2017**, 170, 49–55.
138. Bandi, R.; Gangapuram, B.R.; Dadigala, R.; Eslavath, R.; Singh, S.S.; Guttana, V. Facile and green synthesis of fluorescent carbon dots from Onion waste and their potential applications as sensor and multicolour imaging agents. *RSC Adv.* **2016**, 6, 28633–28639.
139. Ngu, P.Z.Z.; Chia, S.P.P.; Fong, J.F.Y.; Ng, S.M. Synthesis of carbon nanoparticles from waste rice husk used for the optical sensing of metal ions. *New Carbon Mater.* **2016**, 31, 135–143.
140. Xue, M.Y.; Zou, M.B.; Zhao, J.J.; Zhan, Z.H.; Zhao, S.L. Green preparation of fluorescent carbon dots from lychee seeds and their application for the selective detection of methylene blue and imaging in living cells. *J. Mater. Chem. B* **2015**, 3, 6783–6789.
141. Lu, W.B.; Qin, X.Y.; Liu, S.; Chang, G.H.; Zhang, Y.W.; Luo, Y.L.; Asiri, A.M.; Al-Youbi, A.O.; Sun, X.P. Economical, Green Synthesis of Fluorescent Carbon Nanoparticles and Their Use as Probes for Sensitive and Selective Detection of Mercury(II) Ions. *Anal. Chem.* **2012**, 84, 5351–5357.
142. Liang, W.; Li, W.T.; Wu, B.; Zhen, L.; Wang, S.L.; Yuan, L.; Pan, D.Y.; Wu, M.H. Facile synthesis of fluorescent graphene quantum dots from coffee grounds for bioimaging and sensing. *Chem. Eng. J.* **2016**, 300, 75–82.
143. Kumar, A.; Chowdhuri, A.R.; Laha, D.; Mahto, T.K.; Karmakar, P.; Sahu, S.K. Green synthesis of carbon dots from *ocimum sanctum* for effective fluorescent sensing of Pb<sup>2+</sup> ions and live cell imaging. *Sens. Actuators B Chem.* **2017**, 242, 679–686.
144. Jie, W.; Qiu, F.; Xin, L.; Wu, H.; Xu, J.; Niu, X.; Pan, J.; Tao, Z.; Yang, D. A facile one-pot synthesis of fluorescent carbon dots from degreases cotton for the selective determination of chromium ions in water and soil samples. *J. Lumin.* **2017**, 188, 230–237.

145. Su, A.M.; Wang, D.; Xin, S.; Zhong, Q.M.; Chen, Y.R.; Liu, J.C.; Wang, Y.L. Synthesis of fluorescent carbon quantum dots from dried lemon peel for determination of carmine in drinks. *Chem. Res. Chin. Univ.* **2018**, 34, 164–168.
146. Zhou, J.J.; Sheng, Z.H.; Han, H.Y.; Zou, M.Q.; Li, C.X. Facile synthesis of fluorescent carbon dots using watermelon peel as a carbon source. *Mater. Lett.* **2012**, 66, 222–224.
147. Yao, Y.Y.; Gedda, G.; Girma, W.M.; Yen, C.L.; Ling, Y.C.; Chang, J.Y. Magnetofluorescent carbon dots derived from crab shell for targeted dual-modality bioimaging and drug delivery. *ACS Appl. Mater. Interfaces* **2017**, 9, 13887–13899.
148. Chunduri, L.A.A.; Kurdekar, A.; Patnaik, S.; Dev, B.V.; Rattan, T.M.; Kamisetti, V. Carbon quantum Dots from coconut husk: Evaluation for antioxidant and cytotoxic activity. *Mater. Focus* **2016**, 5, 55–61.
149. Zhang, P.; Wei, J.S.; Chen, X.B.; Xiong, H.M. Heteroatom-doped carbon dots based catalysts for oxygen reduction reactions. *J. Colloid Interface Sci.* **2019**, 537, 716–724.
150. Konar, S.; Kumar, B.P.; Mahto, M.K.; Samanta, D.; Shaik, M.A.S.; Shaw, M.; Mandal, M.; Pathak, A. N-doped carbon dot as fluorescent probe for detection of cysteamine and multicolor cell imaging. *Sens. Actuators B Chem.* **2019**, 286, 77–85.
151. Pathak, A.; Suneesh, P.; Stanley, J.; Babu, T.S. Multicolor emitting N/S-doped carbon dots as fluorescent probe for imaging pathogenic bacteria and human buccal epithelial cells. *Microchim. Acta* **2019**, 186, 157–167.
152. Sun, Y.P.; Shen, C.; Wang, J.; Lu, Y. Facile synthesis of biocompatible N, S-doped carbon dots for cell imaging and ion detecting. *RSC Adv.* **2015**, 5, 16368–16375.
153. Hu, Z.X.; Jiao, X.Y.; Xu, L. The N, S co-doped carbon dots with excellent luminescent properties from green tea leaf residue and its sensing of gefitinib. *Microchem. J.* **2020**, 154, 104588–104596.
154. Li, Y.; Hu, Y.; Zhao, Y.; Shi, G.; Deng, L.; Hou, Y.; Qu, L. An electrochemical avenue to green-luminescent graphene quantum dots as potential electron-acceptors for photovoltaics. *Adv. Mater.* **2011**, 23, 776–780.
155. Li, X.; Wang, H.; Shimizu, Y.; Pyatenko, A.; Kawaguchi, K.; Koshizaki, N. Preparation of carbon quantum dots with tunable photoluminescence by rapid laser passivation in ordinary organic solvents. *Chem. Commun.* **2010**, 47, 932–934.
156. Shenderova, O.; Hens, S.; Vlasov, I.; Turner, S.; Lu, Y.G.; Tendeloo, G.V.; Schrand, A.; Burikov, S.A.; Dolenko, T.A. Carbon-dot-decorated nanodiamonds. *Part. Part. Syst. Charact.* **2014**, 31, 580–590.
157. Dimos, K. Carbon quantum dots: Surface passivation and functionalization. *Curr. Org. Chem.* **2016**, 20, 682–695.
158. Pan, J.H.; Zheng, Z.Y.; Yang, J.Y.; Wu, Y.Y.; Lu, F.S.; Chen, Y.W.; Gao, W.H. A novel and sensitive fluorescence sensor for glutathione detection by controlling the surface passivation degree of carbon quantum dots. *Talanta* **2017**, 166, 1–7.
159. Li, L.B.; Dong, T. Correction: Photoluminescence tuning in carbon dots: Surface passivation or/and functionalization, heteroatom doping. *J. Mater. Chem. C* **2019**, 7, 3105.
160. Atchudan, R.; Edison, T.N.J.I.; Perumal, S.; Selvam, N.C.S.; Lee, Y.R. Green synthesized multiple fluorescent nitrogen-doped carbon quantum dots as an efficient label-free optical nanoprobe for in vivo live-cell imaging. *J. Photochem. Photobiol. A Chem.* **2019**, 372, 99–107.
161. Chung, H.K.; Wongso, V.; Sambudi, N.S. Biowaste-derived carbon dots/hydroxyapatite nanocomposite as drug delivery vehicle for acetaminophen. *J. Sol-Gel Sci. Technol.* **2020**, 93, 214–223.
162. Ying, Z.; Yao, L.; Li, Y.Q.; He, Z.Y.; Quan, X.; Chen, Y.S.; Street, J.S.; Hao, G.; Nelles, M. Multicolor carbon nanodots from food waste and their heavy metal ion detection application. *RSC Adv.* **2018**, 8, 23657–23662.
163. Liu, X.Q.; Wang, T.; Wang, W.J.; Zhou, Z.P.; Yan, Y.S. A tailored molecular imprinting ratiometric fluorescent sensor based on red/blue carbon dots for ultrasensitive tetracycline detection. *J. Ind. Eng. Chem.* **2019**, 72, 100–106.

164. Zhang, R.; Liu, Y.B.; Yu, L.; Li, Z.; Sun, S.Q. Preparation of high-quality biocompatible carbon dots by extraction, with new thoughts on the luminescence mechanisms. *Nanotechnology* **2013**, 24, 225601–225610.
165. Li, H.; He, X.; Liu, Y.; Huang, H.; Lian, S.; Lee, S.T.; Kang, Z. One-step ultrasonic synthesis of water-soluble carbon nanoparticles with excellent photoluminescent properties. *Carbon* **2011**, 49, 605–609.
166. Li, H.; Kang, Z.; Liu, Y.; Lee, H.T. Carbon nanodots: Synthesis, properties and applications. *J. Mater. Chem.* **2012**, 22, 24230–24253.
167. Yuan, Y.H.; Liu, Z.X.; Li, R.S.; Zou, H.Y.; Lin, M.; Liu, H.; Huang, C.Z. Synthesis of nitrogen-doping carbon dots with different photoluminescence properties by controlling the surface states. *Nanoscale* **2016**, 8, 6770–6776.
168. Sun, D.; Ban, R.; Zhang, P.H.; Wu, G.H.; Zhang, J.R.; Zhu, J.J. Hair fiber as a precursor for synthesizing of sulfur and nitrogen-co-doped carbon dots with tunable luminescence properties. *Carbon* **2013**, 64, 424–434.
169. Ding, H.; Yu, S.B.; Wei, J.S.; Xiong, H.M. Full-color light-emitting carbon dots with a surface-state-controlled luminescence mechanism. *ACS Nano* **2016**, 10, 484–491.
170. Cheng, C.G.; Shi, Y.N.; Li, M.; Xing, M.; Wu, Q.L. Carbon quantum dots from carbonized walnut shells: Structural evolution, fluorescence characteristics, and intracellular bioimaging. *Mater. Sci. Eng. C* **2017**, 79, 473–480.
171. Rodrigues, C.V.; Correa, J.R.; Aiube, C.M.; Andrade, L.P.; Galvão, P.M.; Costa, P.A.; Campos, A.L.; Pereira, A.J.; Ghesti, G.F.; Felix, J.F. Down-and up-conversion photoluminescence of carbon-dots from brewing industry waste: Application in live cell-imaging experiments. *J. Braz. Chem. Soc.* **2015**, 26, 2623–2628.
172. Wei, J.M.; Zhang, X.; Sheng, Y.Z.; Shen, J.M.; Huang, P.; Guo, S.K.; Pan, J.Q.; Liu, B.T.; Feng, B.X. Simple one-step synthesis of water-soluble fluorescent carbon dots from waste paper. *New J. Chem.* **2014**, 38, 906–909.
173. Mewada, A.; Pandey, S.; Shinde, S.; Mishra, N.; Oza, G.; Thakur, M.; Sharon, M.; Sharon, M. Green synthesis of biocompatible carbon dots using aqueous extract of *Trapa bispinosa* peel. *Mater. Sci. Eng. C Mater. Biol. Appl.* **2013**, 33, 2914–2917.
174. Cheng, C.G.; Xing, M.; Wu, Q.L. A universal facile synthesis of nitrogen and sulfur co-doped carbon dots from cellulose-based biowaste for fluorescent detection of Fe<sup>3+</sup> ions and intracellular bioimaging. *Mater. Sci. Eng. C* **2019**, 99, 611–619.
175. Prasannan, A.; Imae, T. One-pot synthesis of fluorescent carbon dots from orange waste peels. *Ind. Eng. Chem. Res.* **2013**, 52, 15673–15678.
176. Tyagi, A.; Tripathi, K.M.; Singh, N.; Choudhary, S.; Gupta, R.K. Green synthesis of carbon quantum dots from lemon peel waste: Applications in sensing and photocatalysis. *RSC Adv.* **2016**, 6, 72423–72432.
177. Sun, X. and Y. Lei, Fluorescent carbon dots and their sensing applications. *TrAC Trends in Analytical Chemistry*, 2017. 89: p. 163-180.
178. Shen, L., et al., Growth and stabilization of silver nanoparticles on carbon dots and sensing application. *Langmuir*, 2013. 29(52): p. 16135-16140.
179. Gao, X., et al., One-pot synthesis of carbon nanodots for fluorescence turn-on detection of Ag<sup>+</sup> based on the Ag<sup>+</sup>-induced enhancement of fluorescence. *Journal of Materials Chemistry C*, 2015. 3(10): p. 2302-2309.
180. Liu, T., et al., Fluorescence detection of mercury ions and cysteine based on magnesium and nitrogen co-doped carbon quantum dots and IMPLICATION logic gate operation. *Sensors and Actuators B: Chemical*, 2016. 231: p. 147-153
181. Lu, W., et al., Carbon nano-dots as a fluorescent and colorimetric dual-readout probe for the detection of arginine and Cu<sup>2+</sup> and its logic gate operation. *Nanoscale*, 2017. 9(32): p. 11545-11552.

182. Gao, X., et al., Carbon quantum dot-based nanoprobe for metal ion detection. *Journal of Materials Chemistry C*, 2016. 4(29): p. 6927-6945.
183. Qu, K., et al., Carbon dots prepared by hydrothermal treatment of dopamine as an effective fluorescent sensing platform for the label-free detection of iron (III) ions and dopamine. *Chemistry—A European Journal*, 2013. 19(22): p. 7243-7249.
184. Luo, P.G., et al., Carbon “quantum” dots for optical bioimaging. *Journal of Materials Chemistry B*, 2013. 1(16): p. 2116-2127.
185. Tuerhong, M., X. Yang, and Y. Xue-Bo, Review on carbon dots and their applications. *Chinese Journal of Analytical Chemistry*, 2017. 45(1): p. 139-150.
186. Sun, Y.-P., et al., Quantum-sized carbon dots for bright and colorful photoluminescence. *Journal of the American Chemical Society*, 2006. 128(24): p. 7756-7757.
187. Mehta, V.N., et al., Preparation of multicolor emitting carbon dots for HeLa cell imaging. *New Journal of Chemistry*, 2014. 38(12): p. 6152-6160.
188. Han, B., et al., Polyethyleneimine modified fluorescent carbon dots and their application in cell labeling. *Colloids and Surfaces B: Biointerfaces*, 2012. 100: p. 209-214.
189. Xu, Y., et al., Nitrogen-doped carbon dots: a facile and general preparation method, photoluminescence investigation, and imaging applications. *Chemistry—A European Journal*, 2013. 19(7): p. 2276-2283
190. Zhang, X., et al., Biocompatible polydopamine fluorescent organic nanoparticles: facile preparation and cell imaging. *Nanoscale*, 2012. 4(18): p. 5581-5584.
191. Hsu, P.-C. and H.-T. Chang, Synthesis of high-quality carbon nanodots from hydrophilic compounds: role of functional groups. *Chemical communications*, 2012. 48(33): p. 3984-3986.
192. Vedamalai, M., et al., Carbon nanodots prepared from o-phenylenediamine for sensing of Cu<sup>2+</sup> ions in cells. *Nanoscale*, 2014. 6(21): p. 13119-13125.
193. Arkan, E., et al., Green synthesis of carbon dots derived from walnut oil and an investigation of their cytotoxic and apoptogenic activities toward cancer cells. *Advanced pharmaceutical bulletin*, 2018. 8(1): p. 149.
194. Shang, W., et al., The uptake mechanism and biocompatibility of graphene quantum dots with human neural stem cells. *Nanoscale*, 2014. 6(11): p. 5799-5806.
195. Zhai, X., et al., Highly luminescent carbon nanodots by microwave-assisted pyrolysis. *Chemical Communications*, 2012. 48(64): p. 7955-7957.
196. Tao, H., et al., In vivo NIR fluorescence imaging, biodistribution, and toxicology of photoluminescent carbon dots produced from carbon nanotubes and graphite. *Small*, 2012. 8(2): p. 281-290.
197. Li, N., et al., Biodistribution study of carbogenic dots in cells and in vivo for optical imaging. *Journal of Nanoparticle Research*, 2012. 14(10): p. 1177.
198. Han, M., et al., Recent progress on the photocatalysis of carbon dots: Classification, mechanism and applications. *Nano Today*, 2018. 19: p. 201-218.
199. Xu, X., et al., Enriching photoelectrons via three transition channels in amino-conjugated carbon quantum dots to boost photocatalytic hydrogen generation. *ACS applied materials & interfaces*, 2016. 8(22): p. 14118-14124.
200. Lu, Y., et al., Facile hydrothermal synthesis of carbon dots (CDs) doped ZnFe<sub>2</sub>O<sub>4</sub>/TiO<sub>2</sub> hybrid materials with high photocatalytic activity. *Journal of Photochemistry and Photobiology A: Chemistry*, 2018. 353: p. 10-18.
201. Yu, X., et al., Preparation and visible light photocatalytic activity of carbon quantum dots/TiO<sub>2</sub> nanosheet composites. *Carbon*, 2014. 68: p. 718-724.
202. Ma, Y., et al., Morphology control and photocatalysis enhancement by in situ hybridization of cuprous oxide with nitrogen-doped carbon quantum dots. *Langmuir*, 2016. 32(37): p. 9418-9427.



203. Zhang, H., et al., Carbon quantum dots/Ag<sub>3</sub>PO<sub>4</sub> complex photocatalysts with enhanced photocatalytic activity and stability under visible light. *Journal of Materials Chemistry*, 2012. 22(21): p. 10501-10506.
204. Zhang, H., et al., Fe<sub>2</sub>O<sub>3</sub>/carbon quantum dots complex photocatalysts and their enhanced photocatalytic activity under visible light. *Dalton Transactions*, 2011. 40(41): p. 10822-10825.
205. De, B., B. Voit, and N. Karak, Carbon dot reduced Cu<sub>2</sub>O nanohybrid/hyperbranched epoxy nanocomposite: mechanical, thermal and photocatalytic activity. *RSC Advances*, 2014. 4(102): p. 58453-58459.
206. Yu, H., et al., ZnO/carbon quantum dots nanocomposites: one-step fabrication and superior photocatalytic ability for toxic gas degradation under visible light at room temperature. *New Journal of Chemistry*, 2012. 36(4): p. 1031-1035.
207. Yu, H., et al., Carbon quantum dots/TiO<sub>2</sub> composites for efficient photocatalytic hydrogen evolution. *Journal of Materials Chemistry A*, 2014. 2(10): p. 3344-3351.
208. Wu, X., et al., Carbon dot and BiVO<sub>4</sub> quantum dot composites for overall water splitting via a two-electron pathway. *Nanoscale*, 2016. 8(39): p. 17314-17321.
209. Sahu, S., et al., Visible-light photoconversion of carbon dioxide into organic acids in an aqueous solution of carbon dots. *Langmuir*, 2014. 30(28): p. 8631-8636.
210. Wang, J., et al., Versatility with carbon dots—from overcooked BBQ to brightly fluorescent agents and photocatalysts. *RSC Advances*, 2013. 3(36): p. 15604-15607.
211. Li, H., et al., Near-infrared light controlled photocatalytic activity of carbon quantum dots for highly selective oxidation reaction. *Nanoscale*, 2013. 5(8): p. 3289-3297.
212. Liu, R., et al., Metal nanoparticle/carbon quantum dot composite as a photocatalyst for high-efficiency cyclohexane oxidation. *Acs Catalysis*, 2013. 4(1): p. 328-336.
213. Essner, J.B. and G.A. Baker, The emerging roles of carbon dots in solar photovoltaics: a critical review. *Environmental Science: Nano*, 2017. 4(6): p. 1216-1263.
214. Sharma, K., V. Sharma, and S. Sharma, Dye-Sensitized Solar Cells: Fundamentals and Current Status. *Nanoscale research letters*, 2018. 13(1): p. 381.
215. Wang, H., et al., Nitrogen-doped carbon dots for “green” quantum dot solar cells. *Nanoscale research letters*, 2016. 11(1): p. 27.
216. Rafique, S., et al., Fundamentals of bulk heterojunction organic solar cells: An overview of stability/degradation issues and strategies for improvement. *Renewable and Sustainable Energy Reviews*, 2018. 84: p. 43-53.
217. Benesperi, I., H. Michaels, and M. Freitag, The researcher's guide to solid-state dye-sensitized solar cells. *Journal of Materials Chemistry C*, 2018. 6(44): p. 11903-11942.
218. Ge, J., et al., Red-emissive carbon dots for fluorescent, photoacoustic, and thermal theranostics in living mice. *Advanced Materials*, 2015. 27(28): p. 4169-4177.
219. Kong, T., et al., Doxorubicin conjugated carbon dots as a drug delivery system for human breast cancer therapy. *Cell proliferation*, 2018. 51(5): p. e12488.
220. Zhou, N., et al., Elucidating the endocytosis, intracellular trafficking, and exocytosis of carbon dots in neural cells. *RSC Advances*, 2014. 4(107): p. 62086-62095.
221. Wang, H.-J., et al., Hyaluronic acid-based carbon dots for efficient gene delivery and cell imaging. *RSC Advances*, 2017. 7(25): p. 15613-15624.
222. Wang, H., et al., Biocompatible PEG-chitosan@ carbon dots hybrid nanogels for two-photon fluorescence imaging, near-infrared light/pH dual-responsive drug carrier, and synergistic therapy. *Advanced Functional Materials*, 2015. 25(34): p. 5537-5547.
223. Sciortino, A., A. Cannizzo, and F. Messina, Carbon Nanodots: A Review—From the Current Understanding of the Fundamental Photophysics to the Full Control of the Optical Response. *C*, 2018. 4(4): p. 67.

- 
224. Yuan, F., et al., Shining carbon dots: synthesis and biomedical and optoelectronic applications. *Nano Today*, 2016. 11(5): p. 565-586.
  225. Zhou, D., et al., Conquering aggregation-induced solid-state luminescence quenching of carbon dots through a carbon dots-triggered silica gelation process. *Chemistry of Materials*, 2017. 29(4): p. 1779-1787.
  226. Chen, Y., et al., A self-quenching-resistant carbon-dot powder with tunable solid-state fluorescence and construction of dual-fluorescence morphologies for white light-emission. *Advanced Materials*, 2016. 28(2): p. 312-318
  227. Zhang, X., et al., Color-switchable electroluminescence of carbon dot light-emitting diodes. *ACS nano*, 2013. 7(12): p. 11234-11241.
  228. Brouwer, A.M., Standards for photoluminescence quantum yield measurements in solution (IUPAC Technical Report). *Pure and Applied Chemistry*, 2011. 83(12): p. 2213-2228.
  229. Tauc, J., R. Grigorovici and A. Vancu, Optical properties and electronic structure of amorphous germanium. *Physica Status Solidi*, 1966. **15**: p. 627-637.
  230. Ozgur, U., Y.I. Alivov, C. Liu, A. Teke, M.A. Reshchikov, S. Dogan, V. Avrutin, S.J. Cho and H. Morkoc, A comprehensive review of ZnO materials and devices. *Journal of Applied Physics*, 2005. **98**(4).

## Pharmacognostic and Phytochemical Evaluation of *Andrographis Serphyllifolia* (Rottl.Ex Vahl.) WT

Venu. Velidi<sup>\*1</sup>, Swaroopa Rani. A<sup>2</sup> and Kothapalli Bonnoth Chandrasekhar<sup>3</sup>

<sup>1,2</sup>Department of Biotechnology, Jawaharlal Nehru technological university, Ananthapur, A.P, 515002, India

<sup>3</sup>Department of Pharmaceutical Chemistry, Jawaharlal Nehru Technological University, Ananthapuram, A.P., 515002, India

### ABSTRACT

*Andrographis serphyllifolia* (Rottl.ex Vahl.) Wt. belonging to the family Acanthaceae is widely used as an herbal drug in treating various diseases in India. In spite of the immense usage, there is no scientific data available regarding the quality standards which may adversely affect the therapeutic properties of the *Andrographis serphyllifolia* (Rottl.ex Vahl.) Wt. Therefore the present study is designed for establishing standards by carrying out pharmacognostic study and screening for phytoconstituents. The pharmacognostical profile includes anatomy of leaf, stem and root; study of quantitative microscopical characters; fluorescence study of the crude drug; physical parameters; extractive values; phytochemical screening showed the presence of major phytoconstituents. Quantitative estimation of total phenolics and flavonoid content by RP-HPLC is demonstrated. In anti-oxidant assay ethanol extract of *Andrographis serphyllifolia* (Rottl.ex Vahl.) Wt. showed excellent scavenging activity. The study reports for the first time, the standardization of the *Andrographis serphyllifolia* (Rottl.ex Vahl.) Wt. drug and the results can be considered as standard in Indian Pharmacopeia

Keywords: *Andrographis serphyllifolia* (Rottl.ex Vahl.) Wt., pharmacognostic, phytochemical screening, RP-HPLC, anti-oxidant

### 1. INTRODUCTION

There is an immense potential usage of medicinal plants as an herbal drug for treating various kinds of ailments. The unwanted side effects of the western medicine are providing a scope for researchers for considering medicinal plants and natural products in the field of Ayurveda to cure diseases. There is growing demand for medicinal plants as it is safe and works with efficacy. India is the land with wide variety of plants which has medicinal values and is one of the mega diversity in the world [1]. A good proportion of different kinds of medicinal plants are significantly distributed throughout the country. In this study Eastern Ghats of Andhra Pradesh is considered for collecting the plant due to richness in the presence of diversified forms of medicinal plants. Many plants have been identified and documented which is used to cure wide range of ailments and diseases by the local tribal community [2]. On communicating with these traditional healers one such plant *Andrographis serphyllifolia* (Rottl.ex Vahl.)Wt (AS) was used in treating inflammation, fever, for liver protection and as an antidote. *Andrographis serphyllifolia* (Rottl.ex Vahl.) Wt. belongs to Acanthaceae family. *Andrographis serphyllifolia* (Rottl.ex Vahl.) Wt. is a prostrate growing herb. A new flavones serphyllin has been reported from *Andrographis serphyllifolia* (Rottl.ex Vahl.) Wt. and the structure has been established by the spectral and synthetic evidences [3]. The literature reports on the anti-venom property of *Andrographis serphyllifolia* (Rottl.ex Vahl.) Wt. [4]. The Hydro-ethanolic extract of Whole plant of *Andrographis serphyllifolia* (Rottl.ex Vahl.) Wt. showed reduction serum biomarkers in diabetic model [5]. On the same lines ethanol extract of leaves of AS showed inhibitory activity against  $\alpha$ -glucosidase in streptozotocin induced diabetic animal model [6]. Invitro anti-inflammatory activity of methanolic extract of root of AS is documented [7]. Anti-proliferative activity of leaf extract [8], hypolipidemic activity of root extract [9], anti-helminthic activity [10] is documented. The plant contains flavon glucosides, Skullcapflavone glucoside [11]. In spite of extensive usage of *Andrographis serphyllifolia* (Rottl.ex Vahl.) Wt. as an herbal drug, the standardisation process has not been reported. The standardisation process is supported by pharmacognostic studies which help in identification, authentication and evaluation according to the guidelines prescribed by WHO. Proper scientific evaluation and standardisation of the herbal drug is very important to be used effectively to use as medicine. Therefore the present study focuses on the standardisation of *Andrographis serphyllifolia* (Rottl.ex Vahl.) Wt.

## 2. MATERIAL AND METHODOLOGY

### MATERIALS

The fresh and healthy whole plant material *Andrographis serphyllifolia* (Rottl.ex Vahl.) Wt; HPLC grade Methanol and Water- Rankem, India; Gallic acid, Quercetin, Diphenyl picryl hydrazyl and Ascorbic acid - Sigma -Aldrich Merck, India; remaining all chemical and stains are laboratory grade, India

### METHODOLOGY

#### 2.1 Collection and Authentication of Plant Material *Andrographis Serphyllifolia* (Rottl.Ex Vahl.) Wt.

The healthy whole plant of *Andrographis serphyllifolia* (Rottl.ex Vahl.) Wt. is collected from Eastern Ghats of Tirupati is authenticated by Professor Madhava Chetty and the sample is preserved in the Herbarium in the Department of Botany, Sri Venkateswara University, Tirupati, A.P. India.

#### 2.2 Macroscopic Character

The macroscopic characters like colour, odour, taste, size, shape of leaf stem and root of fresh plant material of *Andrographis serphyllifolia* (Rottl.ex Vahl.) Wt. is noted

#### 2.3 Microscopic Character

The transverse section of leaf, stem and root were stained with Methylene blue, mounted on grease free slide and observed under compound microscope. The distinguishing characters of the tissue system were observed and recorded.

#### 2.4 Determination of Stomatal Number

Stomatal number is determined by placing a piece of leaf in chloral hydrate solution. The solution is boiled. Upper and lower epidermis of the leaf is peeled off and is placed is mounted on the slide in glycerine water. Number of stomata present in the area of 1sq mm is counted using camera lucida. Average number of stomata per sq mm present in ten fields is calculated

#### 2.5 Determination of Stomatal Index

Stomatal index is the percentage which the number of stomata forms to the total number of epidermal cells. It is calculated using the formula

$$I = \frac{S}{E+S} \times 100$$

Where, I = stomatal index

S = no. of stomata

E = no. of epidermal cells.

#### 2.6 Determination of Vein Islet Number

It is determined by counting the number of vein-islets in an area of 4 sq mm of the central part of the leaf between the midrib and margin.

#### 2.7 Powder Analysis

The aerial parts of *Andrographis serphyllifoila* (Rottl.ex Vahl.) Wt. was collected washed under running tap water to remove the dirt adhering to it and then rinsed with distilled water. The plant material was shade dried and was pulverized using a mechanical blender. The fine powder obtained was subjected to organoleptic study, fluorescent study and for physicochemical characterisation of the plant material.

#### 2.8 Organoleptic Evaluation

The powdered aerial part of *Andrographis serphyllifoila* (Rottl.ex Vahl.) Wt. is assessed for the colour, odour and texture. The organoleptic evaluation is done according to the textual methods.

#### 2.9 Physicochemical Parameters

According to the WHO guidelines and Indian Pharmacopoeia standardisation methods have to be followed to determine the presence of moisture content, total ash, acid insoluble ash, water-alcohol extractive values. The average percentage w/w of ash content, moisture content and the extractive values, crude fibre content were determined and recorded [12-14].

#### 2.10 Fluorescent Study

Many medicinal plants or the powder shows the fluorescence character when exposed to UV light. This is an important type in the standardisation method which helps in the identification of plant. The small amount of fine powder was taken on the grease free slide and treated with hydrochloric acid, nitric acid, ammonia, sodium

hydroxide etc separately and were where placed in the ultra violet viewer chamber and viewed in day light, short (254nm), long (365nm) ultraviolet radiation. The colour observed on treating with different reagents reveals the presence of significant constituents which has fluorescence character [15].

### 2.11 Soxhlet Extraction

The whole plant material of *Andrographis serphyllifolia* (Rottl.ex Vahl.)Wt. was washed to remove dirt and soil particles. The material was shade dried for 7 days. The dried material was grounded to coarse powder. The coarse powder was then stored in the desiccator to remove the moisture content. Using Soxhlet apparatus 500g of the powder is subjected for successive extractions by using solvents petroleum ether, chloroform and ethanol for 17 hrs respectively. The solvents were evaporated by flash rotary vacuum evaporator and the crude extract was weighed to get percentage of yield. The extracts were kept in the desiccator to remove the moisture and subjected for further phytochemical screening [16].

### 2.12 Preliminary Phytochemical Analysis

The preliminary phytochemical screening of petroleum ether extracts, chloroform and ethanolic extracts of *Andrographis serphyllifolia* (Rottl.ex Vahl.) Wt were performed according to the procedure prescribed in [16, 17].

### 2.13 Estimation of Total Phenolics by Reverse Phase High Performance Liquid Chromatography (RP-HPLC) [18]

**Preparation of Mobile Phase:** Mobile phase was prepared by mixing 60 parts of HPLC grade Methanol and 40 parts of HPLC grade Water. The solution is sonicated in ultrasound sonicator for 10mins and filtered through 0.45 micron Millipore filters. Total volume of 500ml is prepared for the experiment

**Preparation of Standard:** For the estimation of total phenolics Gallic acid is considered as standard. From the stock concentration of 1mg/ml solution of gallic acid 50µg/ml of working solution is prepared. The diluent used in the preparation of solution is HPLC grade Methanol. The solution is sonicated in ultrasound sonicator for 10mins and filtered through 0.45 micron Millipore filters.

**Preparation of Sample:** The 1mg ethanol extract of *Andrographis serphyllifolia* (Rottl.ex Vahl.)Wt is weighed and diluted to 1ml with HPLC grade methanol. The solution is sonicated in ultrasound sonicator for 10min and filtered through 0.45 micron Millipore filters.

**Chromatographic Conditions:** The optimized chromatographic condition followed is summarized in the table below:

**Table:** Chromatographic conditions for Estimation of Total phenolics by RP-HPLC

Parameters	Used/applied
Detector	Shimadzu spd10A UV-Vis, Japan
Pump	Shimadzu LC-10ATVP, Japan
Software	Baseline chromatography Data System N2000
Injection valve	7725i Rheodyne 20µl, USA
Syringe	50µl Hamilton, Switzerland
Column	Phenomenex Gemini-NX-5 µm C18(2) 110 Å, LC Column 250 x 4.6 mm, Ea
Flow rate	1ml/min
Wave length	254nm
Elution	Isocratic
Mobile phase	Methanol: water (60:40)

### CALCULATION:

The total content of phenolics in the ethanol extract of *Andrographis serphyllifolia*(Rottl.ex Vahl.) Wt is calculated by the formula

Sample Area x Standard weight x sample dilution x percentage purity of standard X100

Standard Area x Sample weight x Standard dilution

## 2.14 Estimation of Flavonoid Content Estimation of Total Phenolics by Reverse Phase High Performance Liquid Chromatography (RP-HPLC) [19]

### Optimized Chromatographic Conditions

**Preparation of Mobile phase:** Mobile phase was prepared by mixing 70 parts of HPLC grade Methanol and 30 parts of HPLC grade phosphate buffer of pH 3.2. The pH of the buffer is adjusted by 0.1N phosphoric acid. The solution is sonicated in ultrasound sonicator for 10mins and filtered through 0.45 micron Millipore filters. Total volume of 500ml is prepared for the experiment

**Preparation of standard:** For the estimation of total phenolics Quercetin is considered as standard. From the stock concentration of 1mg/ml solution of gallic acid 100µg/ml of working solution is prepared. The diluent used in the preparation of solution is HPLC grade Methanol. The solution is sonicated in ultrasound sonicator for 10min and filtered through 0.45 micron Millipore filters.

**Preparation of sample:** The 1mg ethanol extract of *Andrographis serphyllifolia*(Rottl.ex Vahl.) Wt is weighed and diluted to 1ml with HPLC grade methanol. The solution is sonicated in ultrasound sonicator for 10min and filtered through 0.45 micron Millipore filters.

**Table:** Chromatographic conditions for Estimation of Total flavonoids by RP-HPLC

Parameters	Used/applied
Detector	Shimadzu spd10A UV-Vis, Japan
Pump	Shimadzu LC-10ATVP, Japan
Software	Baseline chromatography Data System N2000
Injection valve	7725i Rheodyne 20µl, USA
Syringe	50µl Hamilton, Switzerland
Column	Phenomenex Gemini-NX-5 µm C18(2) 110 Å, LC Column 250 x 4.6 mm, Ea
Flow rate	1ml/min
Wave length	280nm
Elution	Isocratic
Mobile phase	Methanol: Phosphate buffer of pH 3.2 (70:30)

### CALCULATION

The total content of flavonoids in the ethanol extract of *Andrographis serphyllifolia*(Rottl.ex Vahl.) Wt is calculated by the formula

$$\frac{\text{Sample Area} \times \text{Standard weight} \times \text{sample dilution} \times \text{percentage purity of standard} \times 100}{\text{Standard Area} \times \text{Sample weight} \times \text{Standard dilution}}$$

### 2.15 Invitro Antioxidant Activities

The extracts from successive solvent extraction are screened for their antioxidant activity.

The petroleum ether, chloroform and ethanol extract were evaluated for their anti-oxidant property. The following anti oxidation test were carried out

#### Diphenyl Picryl Hydrazyl Radical Scavenging Assay

The DPPH scavenging assay of test extracts was carried out according to Cuendet et al., 1997. The dose dependent pattern of assay was carried out. The scavenging activity of extracts reduces DPPH to diphenyl picryl hydrazine which is inferred by the conversion of purple colour to light yellow colour. The inhibition activity is read at 517nm and percentage of inhibition is calculated [20].

#### Hydroxyl Radical Scavenging Assay

Hydroxyl radical scavenging was carried out according to Okawa et al., 1979. Butylated hydroxyl toluene is standard. The dose dependent pattern of assay was carried out for three extracts. The inhibition activity is read at 412nm and percentage of inhibition is calculated [21].

#### Nitric Oxide Scavenging Assay

Nitric oxide scavenging assay was assessed as per Garratt, 1964 for all the test extracts. The dose dependent pattern of assay was carried out. The inhibition activity is read at 540nm and percentage of inhibition is calculated taking Gallic acid [22].

## CALCULATION

The percentage of inhibition is calculated by using the formula

$$I = \frac{(\text{Absorbance of control} - \text{Absorbance of test})}{\text{Absorbance of control}} \times 100.$$

Where, I= percentage of Inhibition

IC50 for each anti-oxidant model is calculated from linear equation  $Y = mx + c$

## 3 RESULTS

### 3.1 Collection, Authentication and General Description of the Plant

The whole plant of *Andrographis serphyllifolia* (Rottl.ex Vahl.) Wt. collected from Eastern Ghats of Tirupati is authenticated by Professor Madhava Chetty and the sample is preserved in the Herbarium in the Department of Botany. The Accession number of the sample is 0847 and is preserved in the herbarium in the Department of Botany, Sri Venkateswara University, Tirupati, A.P. India.

*Andrographis serphyllifolia* (Rottl.ex Vahl.) Wt. is a trailing herb, remains on the ground and is borne on a stout root stock. The leaf is circular in shape sub –opposite, sessile and has shaggy long hairs. The flowers are pale purple. They are found in the upper axils as racemes, sometimes are solitary. Calyx lobes are very slender.

### 3.2 MACROSCOPIC STUDY

The leaves are circular which measures upto 1 inch in diameter. Leaves are oblong and lanceolate sessile and has shaggy long glandular hairs on both abaxial and adaxial surface. Inflorescence is Raceme type not exceeding the leaves. The calyx of the flower is lanceolate with sub equal lobes. Corolla is tubular with 2+3 lipped condition which is unequal. Fruit is a capsule, oval, glabrous and acute at both the ends. It measures 0.4 inches long and 0.2 inches broad (Fig 1).



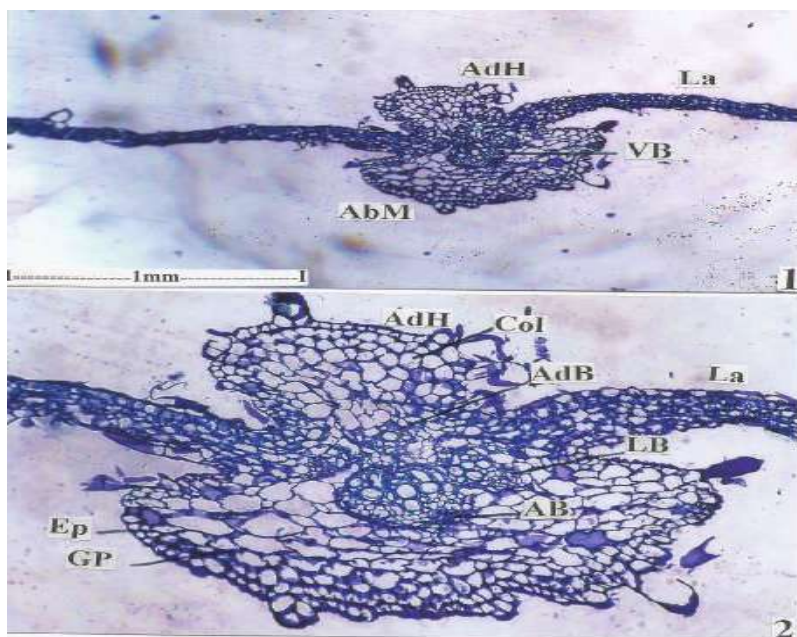
**Fig 1:** *Andrographis serphyllifolia* (Rottl.ex Vahl.) Wt. (whole plant)

### 3.3 MICROSCOPIC STUDY

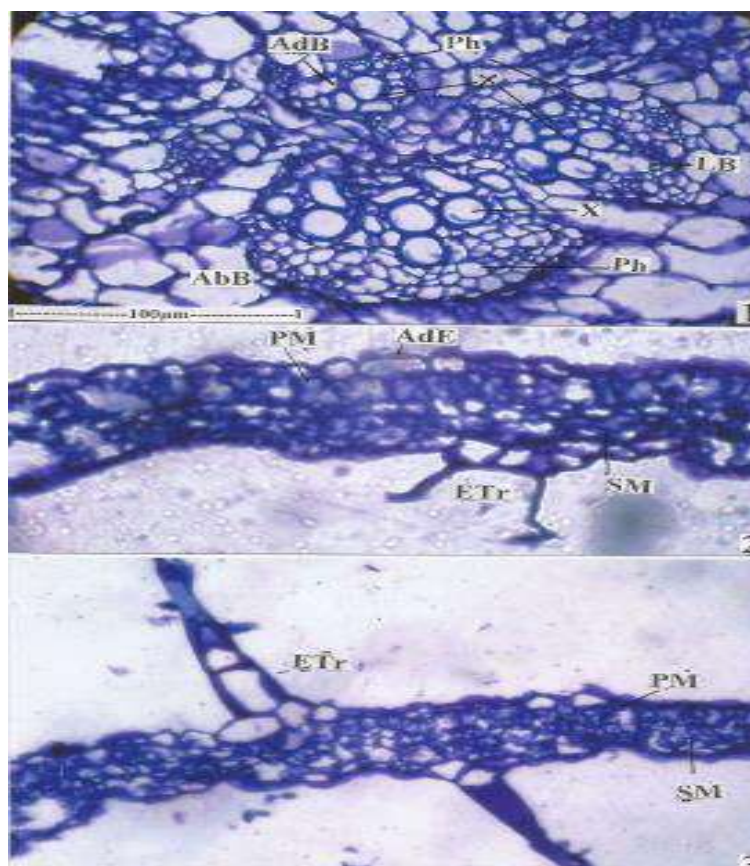
#### LEAF

The leaf consists of thin and membranous lamina and thick-wide mid rib. The middle rib includes thick adaxial hump and wide semicircular abaxial part. The mid rib is 600 $\mu$ m thick; the adaxial hump is 350 $\mu$ m wide and 250 $\mu$ m thick; the abaxial midrib is 350 $\mu$ m in vertical axis and 450 $\mu$ m wide. The mid-rib has epidermal layer with small, square thick walled cells. The cells in the peripheral part of the abaxial hump are collenchymatous. The cells in the peripheral part of the abaxial midrib are collenchymatous and those interior in the midrib are parenchymatous. The transverse section of leaf upper epidermis showed the absence of stomata. The diacytic stomata are seen in the lower epidermis. The midrib has complex vascular system. There is a large, abaxially placed abaxial vascular bundle. There are three smaller bundles located along the adaxial and lateral portions of the midrib. The vascular bundles are collateral possessing inner xylem and outer phloem. The xylem elements are wide, circular and thick walled measuring 25 $\mu$ m in diameter. The phloem elements are well developed; they are wide angular on outline and thick walled. The lamina exhibits dorsi-ventral symmetry, having single layer of short, compact palisade cells and three or four layers of spherical less compact spongy parenchyma cells. The lamina is 50 $\mu$ m thick. Epidermal trichomes are non-glandular and are common on the lamina. The trichomes are

multicellular, uniseriate, unbranched; they are wider at the base and tapering towards the tip. The trichomes are 250µm long (Fig 2 and 3).



**Fig 2:** Transverse section of leaf through midrib with lateral lamina (ABM: abaxial part of midrib; ADH: adaxial part of midrib; AB: abaxial vascular bundle; AdB: adaxial vascular bundle; Col: collenchyma; Ep: epidermis; GP: ground parenchyma; La: lamina; LB: lateral bundle; VB: vascular bundle)

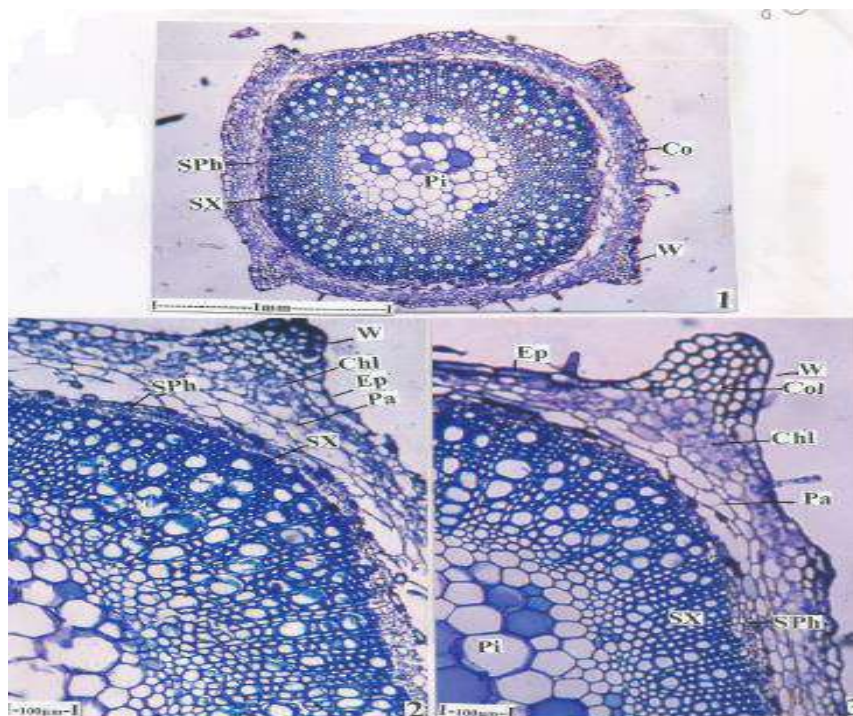


**Fig 3:** 1) Vascular bundle of the midrib enlarged 2) Transverse section of lamina 3) Epidermal trichomes on the lamina. (AbB: abaxial bundle; AdB: adaxial bundle; AdE: adaxial epidermis; ETr: epidermal trichome; LB: lateral bundle; Ph: phloem; PM: Palisade mesophyll; SM: spongy mesophyll; X: xylem)

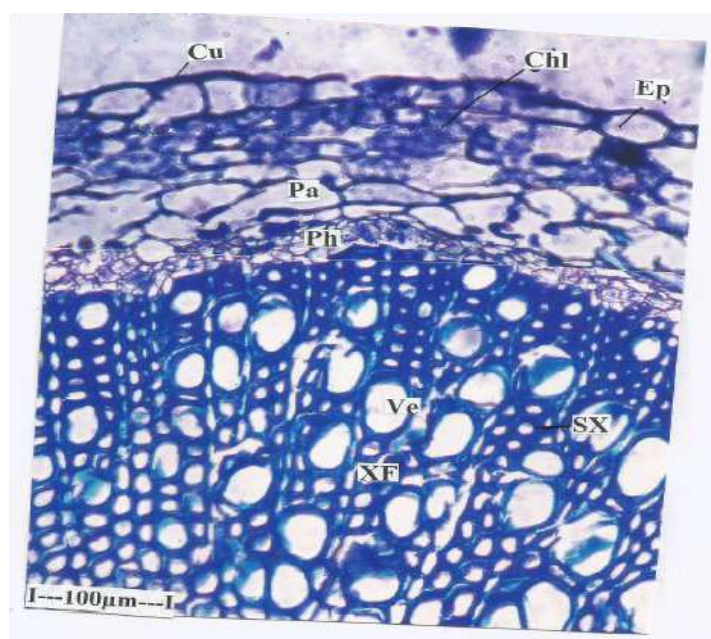
**Stem:** The section studies is done in young and old stem



**Young Stem:** Young stem is four angles with short thick wings on the four corners (Fig). the stem consists of a thick epidermal layer of squares, fairly wide cells with prominent cuticle. The critical zone includes two or three layers of chlorenchyma cells and inner two to four compact cylindrical parenchyma cells. The cortical zone is 2mm thick. The wings are short, thick and measures 200 $\mu$ m in height and 170 $\mu$ m in thickness. The cells within the wings are angular thick walled and compact. The vascular cylinder is thick hollow cylinder enclosing wide pith. Phloem occurs in this compact layer on the outer part of the xylem cylinder. Xylem cylinder consists of secondary xylem and the tissue includes vessels, xylem fibres and xylem rays. The vessels are wide and thick walled. At certain regions the vessels occur as short radial multiples. The vessels are 20-60 $\mu$ m wide. The xylem fibres narrow highly thick walled and lignified. They occur in compact radial lines. Xylem rays are thin; the cells are narrow and rectangular. The ray cells are thick walled and lignified. The pith is wide; the pith cells are polyhedral thin walled and compact (Fig 4 and 5).

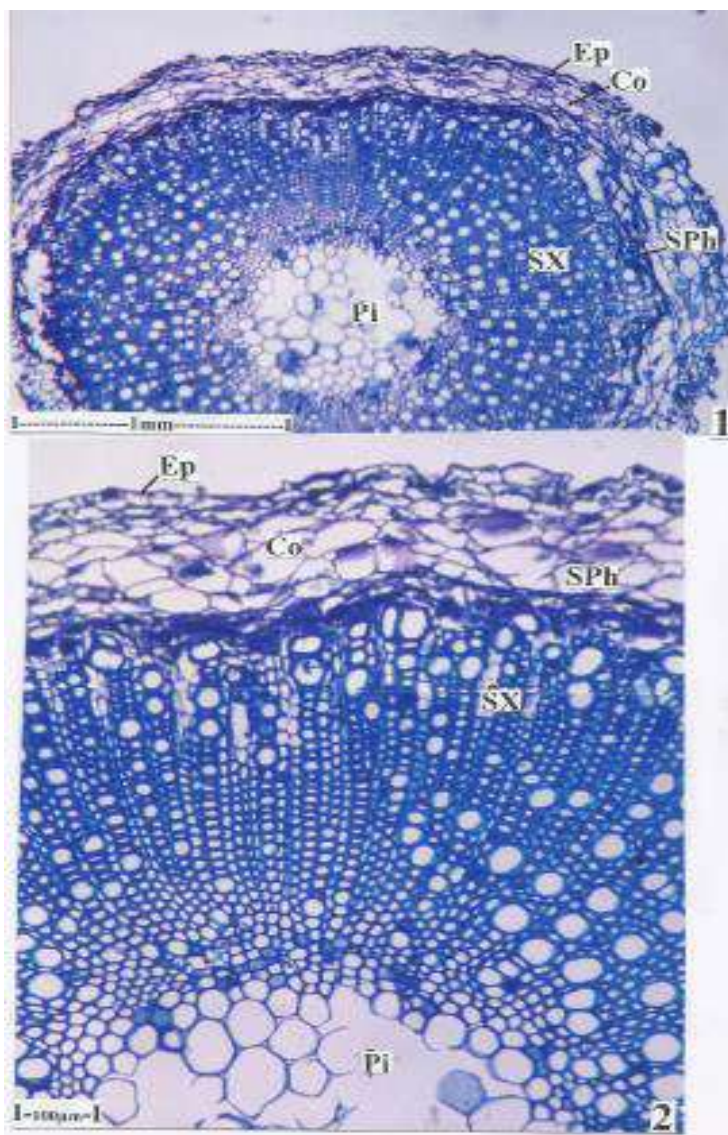


**Fig 4:** Transverse section of young stem; 2 and 3: A section of transverse section of stem showing wing (Chl: chlorenchyma; Co: cortex; Col: collenchyma; Ep: epidermis; Pa: parenchyma; Pi: pith; Sph: secondary phloem; Sx: secondary xylem; W: wings)



**Fig 5:** Transverse section of young stem- A section in-between the wings (Cu: cuticle; Chl: chlorenchyma; Ep: epidermis; Pa: parenchyma; Sx: secondary xylem; Ph: phloem; Ve: vessel; XF: xylem fibres)

**Old Stem (Thick Stem):** The old stem is 2mm thick. The stem shows much thicker secondary xylem. The cortical zone is 200 $\mu$ m thick; the secondary xylem is 700 $\mu$ m thick from inner to the anterior periphery of the cylinder. The epidermis is intact. The epidermal cells are cylindrical and are thin walled. The cortical zone includes six to seven thin walled compact parenchyma cells. Secondary phloem consists of much compressed sieve elements which are inter mixed with sclerenchyma cells. Secondary xylem is in the form of hollow thick cylinder, enclosing narrow pith. The inner part of the xylem cylinder consists of primary xylem. The outer zone includes secondary xylem where these are mostly solitary vessels. The vessels are circular, thick walled and are diffuse in distribution. Both narrow and wide vessels are seen. The vessels are 20-50 $\mu$ m in diameter. Xylem fibres are squarish in sectional view with thick lignified walls. They occur in compact regular radial lines (Fig 6).

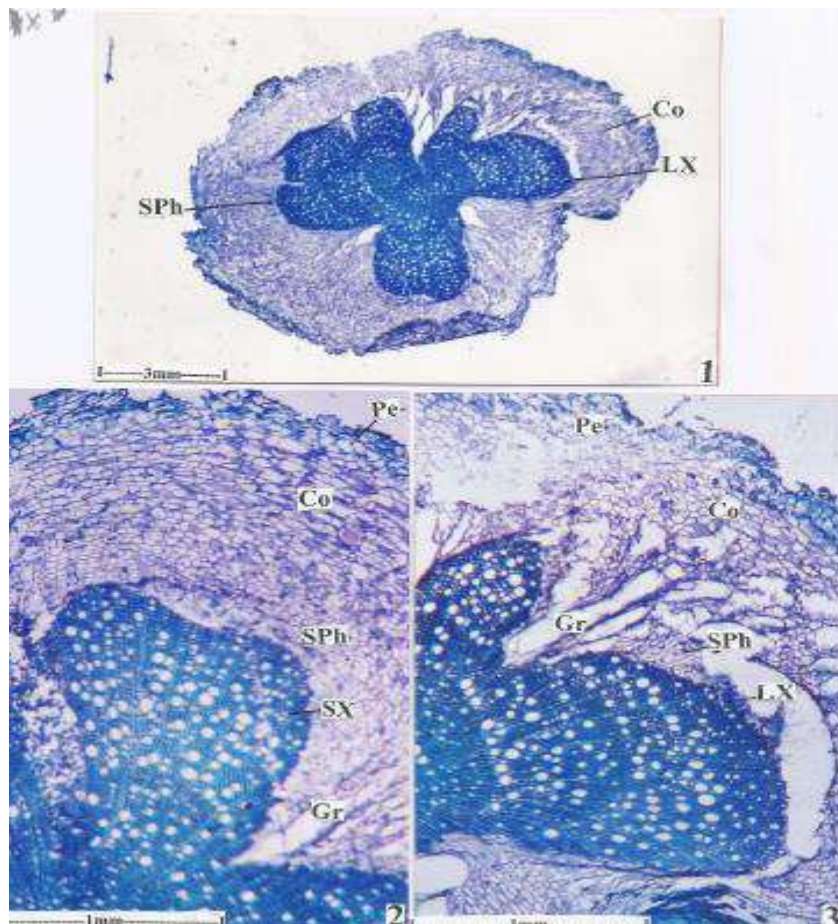


**Fig 6:** Transverse section of old stem (Co: cortex; Ep: epidermis; Pi: pith; Sx: secondary xylem; Sph: secondary phloem)

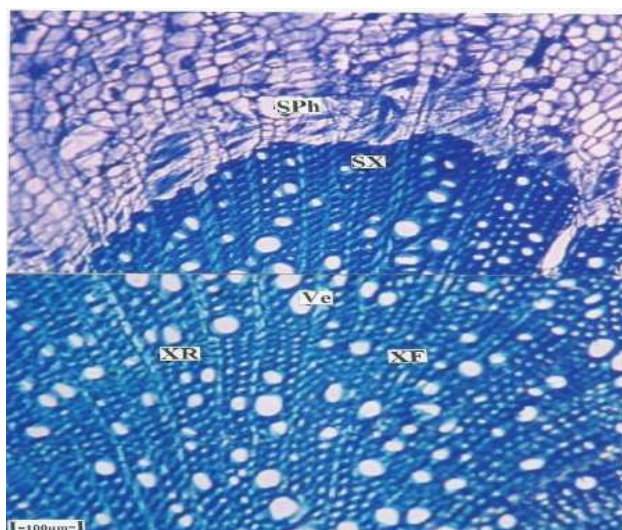
### ROOT

The T.S. of thick matures root was studied. The root consists of figured surface; the epidermis and periderm are collapsed and removed. However periderm is seen as thin, a few layered zone. The cortical portion is very thick, homogenous and parenchymatous. Secondary phloem is thick zone of large, thin walled cells. The phloem elements occur in regular compact parallel radial lines. Secondary xylem is unusual type and it is said to be anomalous in secondary growth. The xylem cylinder is deeply grooved into thick segment which varies in thickness. They spread in fan shaped outline. The xylem represents unequal activity which produces more secondary xylem at four or five points than the alternate places. As a result the secondary xylem becomes deeply divided into unequal segments. Secondary xylem consists of vessels, xylem fibres and xylem rays. The vessels are solitary and diffuse in distribution. The vessels are thin walled and circular and the diameter being

20-40µm in diameter. The xylem fibres are narrow, thick walled and lignified. The fibres occur in compact straight radial lines. Xylem rays are thin and exhibits single radial line of one row of cells. The cells are radially elongated and thick walled (Fig 7 and 8).



**Fig 7:** Transverse section of root (Sph: secondary phloem; Co: cortex; Lx: lignified xylem; Pe: periderm; Sx: secondary xylem; Gr: groove)



**Fig 8:** Transverse section of enlarged cortical portion of the root (Sph: secondary phloem; Sx: secondary xylem; XR: xylem rays; XF: xylem fibre; Ve: vessel)

### 3.1 Microscopical Values of the Leaves (Stomatal number, Stomatal index, and Vein islet number)

The fresh leaves of *Andrographis serphyllifolia* (Rottl.ex Vahl.) Wt. studied for its pharmacognostic standards reports the quantification of some microscopical values of the leaves. The values are represented in the table

**Table 1:** Quantitative Microscopical values of leaf of *Andrographis serphyllifolia* (Rottl.ex Vahl.) Wt.

S.No	Parameters studied	Leaf
1	Stomatal number	
	Upper surface	-
	Lower surface	18 per sq mm
2	Stomatal Index	
	Upper surface	-
	Lower surface	29%
3	Vein islet number	22 per sq mm
4	Vein termination number	8 per sq mm

### 3.2 Powder Microscopic Study of Aerial Parts of the Plants.

The powder is green with strong odour and bitter taste. Fine powder was taken on a grease free slide stained with safranin and mounted with glycerine. The microscopic study of the powdered aerial parts of the plant showed the presence of Multi-cellular covering trichomes (Fig 9), unicellular covering trichomes (Fig 15), diacytic stomata (Fig 14), spiral vessel (Fig 13), cystoliths (Fig 16) and fibres (Fig 10 and 12).



Fig 9: Multicellular Trichomes



Fig 10: Presence of Fibre



Fig 11: Xylem

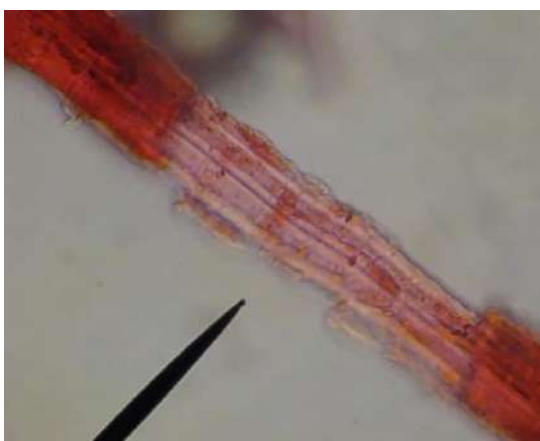


Fig 12: Bundles of fibre



Fig 13: Spiral vessel



Fig 14: Diacytic Stomata



Fig 15: Unicellular trichomes



Fig 16: Cystoliths

### 3.3 Organoleptic Evaluation

The organoleptic evaluation of leaves indicated dark green colour in appearance on both upper and lower part of the leaf. The stem appeared brown and bitter in taste. The powder material of the whole plant was coarse with slight aromatic odour and tasted bitter.

### 3.4 Physicochemical Parameters

The whole plant of *Andrographis serphyllifolia* (Rottl.ex Vahl.) Wt. subjected to selected physicochemical parameters which are very important for the standardisation of the herbal drug. The values of are tabulated in the table 2.

Table 2: Physicochemical parameters of *Andrographis serphyllifolia* (Rottl.ex Vahl.) Wt.

S.No	Parameters	Results in percentage
1	Moisture content	0.47%
2	Total Ash	13%
3	Acid-insoluble ash	5.80%
4	Water soluble ash	7.00%
5	Alcohol soluble extractive value	17.00%
6	Water soluble extractive value	9%

### 3.5 FLUORESCENT STUDY

Some of the phytoconstituents will possess the fluorescent activity when treated with chemicals. The chromophore activity of coarse powder of *Andrographis serphyllifolia*(Rottl.ex Vahl.) Wt. is evaluated under near and far ultra violet rays and reported in the table 3.

Table 3: Fluorescent analysis of drug powder of *Andrographis serphyllifolia* (Rottl.ex Vahl.) Wt.

S.No	Treatment	Day light	UV light	
			Short 254nm	Long 365nm
1	Powder	Green	Dark brown	Dark brown

2	Powder+H <sub>2</sub> O	Dark green	Dark brown	Green
3	Powder+1N HCl	Brownish green	Dark brown	Light green
4	Powder+1N HNO <sub>3</sub>	Brown	Dark brown	Dark green
5	Powder+1N H <sub>2</sub> SO <sub>4</sub>	Pale brown	Dark brown	Dark green
6	Powder+1N NaOH	Dark green	Dark brown	Mustard yellow
7	Powder+Alc. NaOH	Pale green	Dark brown	Mustard yellow
8	Powder+1N KOH	Dark green	Dark brown	Dark green
9	Powder+Alc. KOH	Dark green	Dark brown	Yellowish green
10	Powder+ Ammonia	Dark green	Dark brown	Green

### 3.6 Extractive Studies

One of the important aspects in extraction process is the percentage of yield of drug obtained when subjected to successive extraction process. The percentage of yield of drug from 500gm of the coarse powder loaded at each successive extraction is calculated and tabulated in the table 4.

**Table 4:** Extractive values of *Andrographis serphyllifolia* (Rottl.ex Vahl.) Wt.

S.No	Solvent used	Results in yield % w/w
1	Petroleum ether	1.6
2	Chloroform	10
3	Ethanol	17

### 3.7 Preliminary Phytochemical Screening

The presence of important phytoconstituents in the petroleum ether, chloroform and ethanol is qualitatively evaluated which gives insight about the pharmacological active principles present in the drug. The extracts are subjected to various tests and the presence of the major class of phytoconstituents are assessed by qualitatively represented in the table 5.

**Table 5:** Phytochemical analysis of *Andrographis serphyllifolia* (Rottl.ex Vahl.) Wt.

Where, + indicated the presence of; - was not determined

Phytochemical analysis of <i>Andrographis serphyllifolia</i> (Rottl.ex Vahl.) Wt.				
Sl.No	Test	Petroleum ether extract	Chloroform extract	Ethanol extract
1	Alkaloids	-	+	+
2	Carbohydrates	-	+	+
3	Glycosides	-	+	+
4	Saponins	-	-	-
5	Phytosterols	+	+	+
6	Fixed oils and fats	+	+	+
7	Resins	+	-	-
8	Tannins	-	+	+
9	Phenols	-	+	+
10	Flavonoids	-	+	+
11	Proteins and amino acids	-	-	-
12	Terpenes	+	+	+
13	Gums and mucilage	-	-	-

### 3.8 Estimation of Total phenolics and Total flavonoids in ethanol extract of *Andrographis serphyllifolia* (Rottl.ex Vahl.) Wt. by RP-HPLC

The most sensitive and accurate quantification method for the estimation of total phenolics and total flavonoids is by RP-HPLC. The blank represents no signals reaching the detector and signifies that mobile phase and column is free from unwanted contaminants (Fig 7 for total phenolics and Fig 20 for total flavonoids). The chromatogram of standard gallic acid is represented in the Fig 18 with the Rt value 2.92. The ethanol extract of the sample run in the same condition shows a sharp peak at Rt 2.94 which overlaps with the Rt of standard. Thus area of these two peaks is considered for calculation. Similarly the standard quercetin chromatogram is represented in the Fig 21 with the RT value 3.86 which coincides with the sample peak in the chromatogram Fig 22 with RT value 3.86. These two peak areas are considered for calculation. Thus, ethanol extract of

*Andrographis serphyllifolia* (Rottl.ex Vahl.) Wt. subjected for the estimation of total phenolics and total flavonoids and the concentration of these phytoconstituents present in it is represented in  $\mu\text{g/ml}$  and tabulated in table 6.

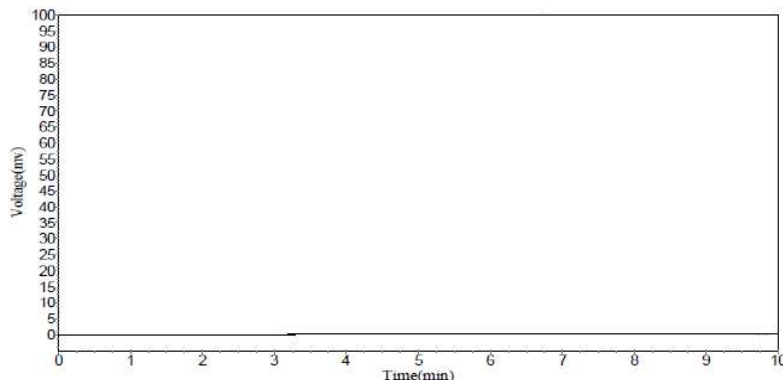


Fig 17: Chromatogram of Blank for Total phenolics

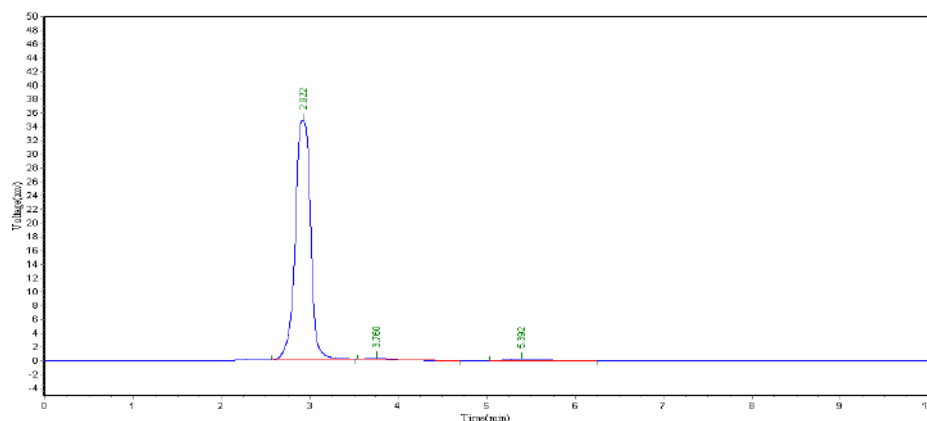


Fig 18: Chromatogram of standard Gallic acid with the RT value of 2.92

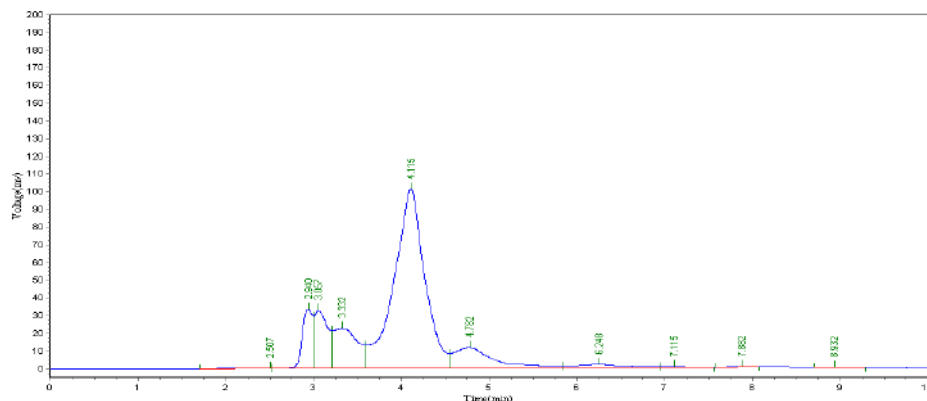
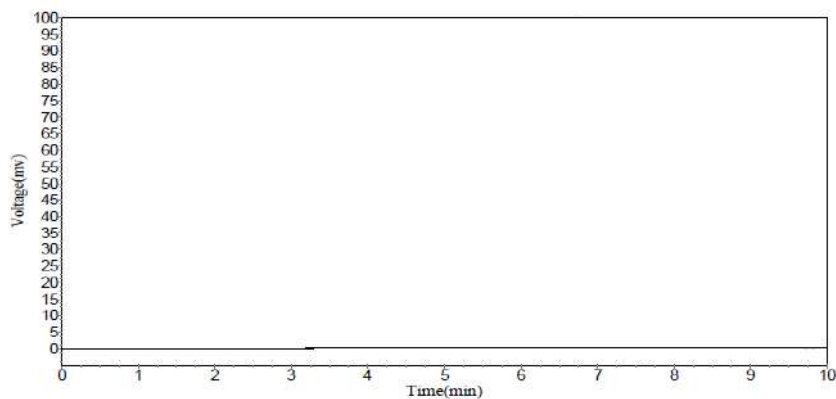
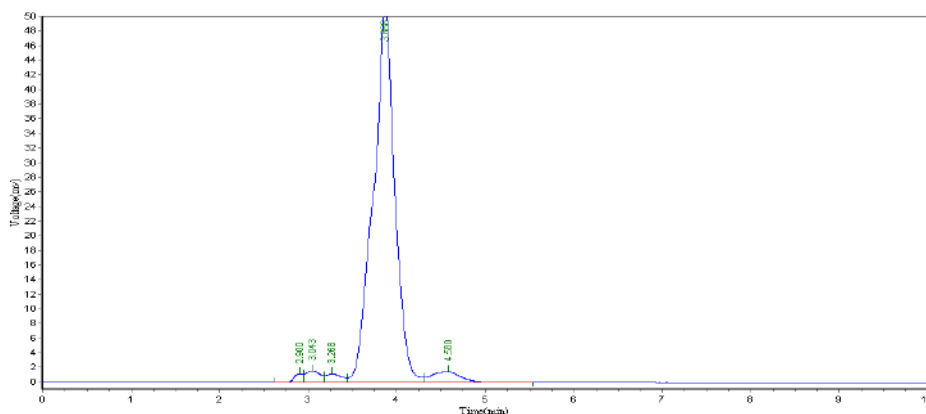


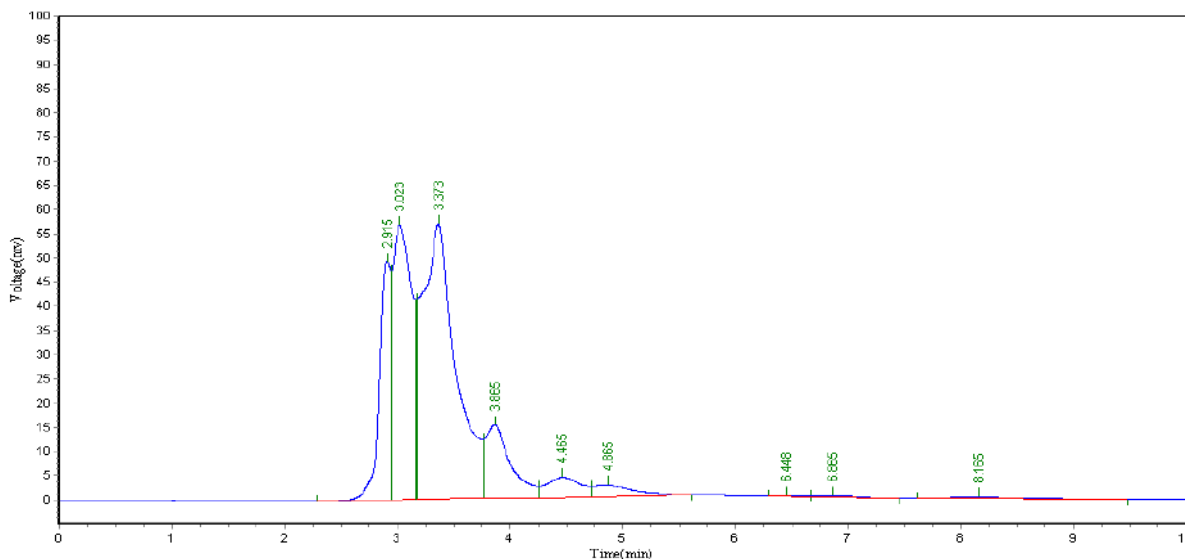
Fig 19: Chromatogram of ethanol extract of AS for total phenolics estimation with the RT value of 2.94



**Fig 20:** Chromatogram of Blank for Total Flavonoids



**Fig 21:** Chromatogram of standard Quercetin for estimation of Total flavonoids with RT value 3.86



**Fig 22:** Chromatogram of ethanol extract of AS for estimation of Total flavonoids with RT value 3.86

**Table 6:** Estimation of total phenol and flavonoids in  $\mu\text{g/ml}$  by RP-HPLC in ethanol extracts of *Andrographis serphyllifolia* (Rottl.ex Vahl.) Wt.

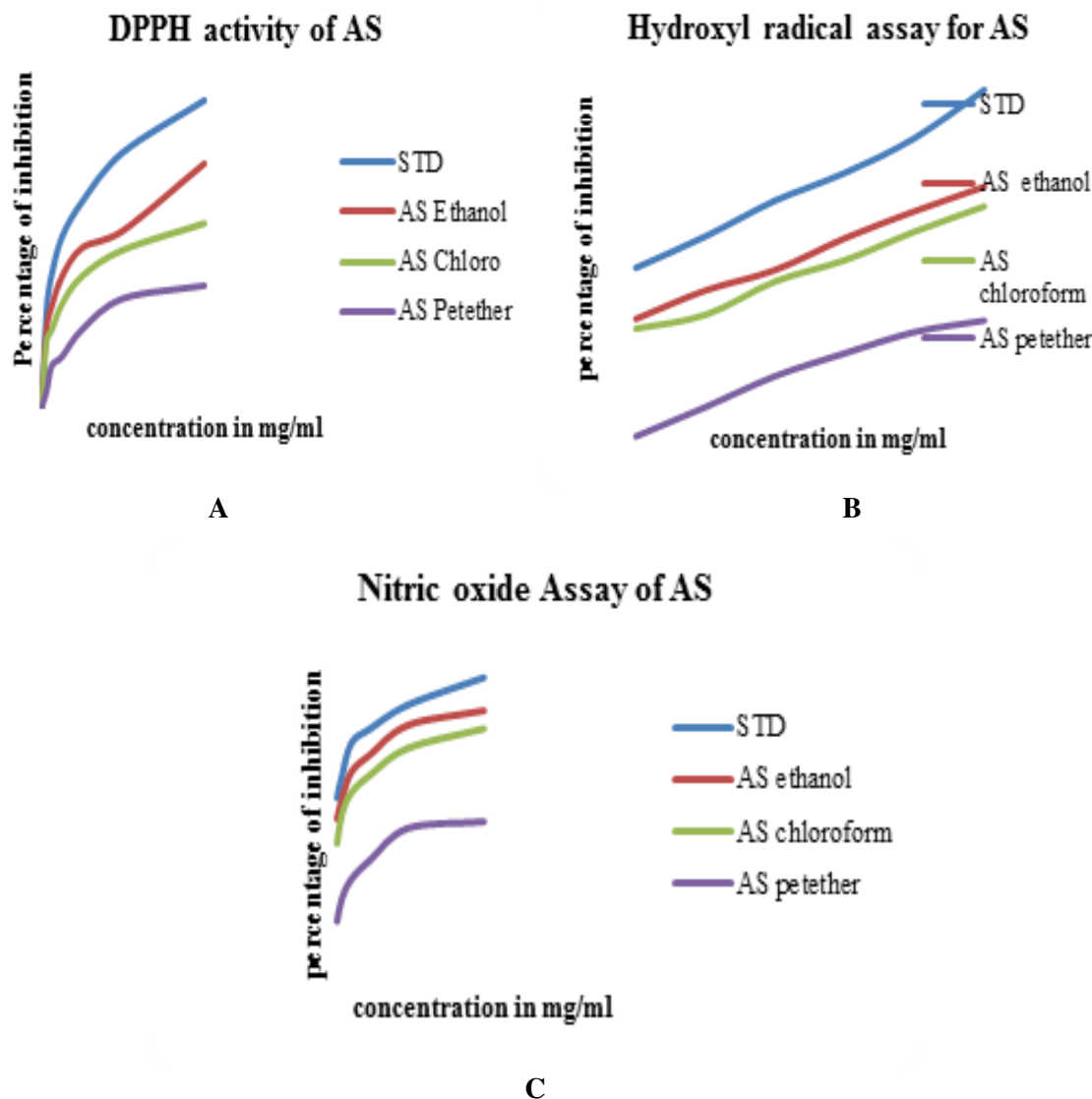
Parameters	Total Gallic acid estimation	Total Flavonoid estimation
purity of standards	98	98
Average Sample area	389575.2083	663410.1513
Average Standard area	463081.7293	864022.5
Sample weight in $\mu\text{g}$	1000	1000
Standard weight in $\mu\text{g}$	50	100
Sample dilution ml	1	1



Standard dilution ml	1	1
Total Content in $\mu\text{g/ml}$	4.12 of gallic acid	7.52 of quercetin

### 3.9 Invitro Antioxidant Activities

The anti-oxidant activities of all the three extract i.e. petroleum ether, chloroform and ethanol of whole plant of *Andrographis serphyllifolia* (Rottl.ex Vahl.) Wt. is subjected to evaluate its scavenging activity. The three model used for this study are DPPH, Hydroxyl radical and Nitric oxide assay method. The concentration of standard ascorbic acid was sent in the range of 31.25 -1000mg/ml following double dilution method. The percentage of inhibition of the extracts is noted which represents the Y axis of the graph and concentration of the standards represents the X axis of the graph (Fig no 23). The IC<sub>50</sub> value in mg/ml of the extracts is calculated by using a linear regression value obtained from the graph and is tabulated in the table no. 7.



**Fig 23:** Invitro anti-oxidant activity: Graphical representation of percentage of inhibition of Petroleum ether, Chloroform and Ethanol extract of *Andrographis serphyllifolia* (Rottl.ex Vahl.) Wt. A) DPPH Assay B) Hydroxyl radical assay and C) Nitric oxide assay

**Table 7:** IC<sub>50</sub> values of ethanol extract (ASE), chloroform extract (ASC) and petroleum ether extract (ASP) of *Andrographis serphyllifolia* (Rottl.ex Vahl.) Wt. All data is represented as mean value with  $\pm$  SEM where n=3

S. No	IC <sub>50</sub> in mg/ml		
	DPPH assay	Hydroxyl radical assay	Nitric oxide assay
STD (Ascorbic acid)	130.0367 $\pm$ 1.66	71.4 $\pm$ 3.91	290.47 $\pm$ 14.67
ASE	380.8833 $\pm$ 2.67	455.22 $\pm$ 3.1	538.89 $\pm$ 15.89
ASC	650.2873 $\pm$ 7.13	621.54 $\pm$ 15.14	738.14 $\pm$ 9.64
ASP	>1000	>1000	>1000

## DISCUSSION

Herbal drug standardisation by using suitable tools is very important for identifying its purity quality, safety and efficacy of the drug. Some of such parameters used in the present study are macroscopic, microscopic, fluorescent, organoleptic evaluation, and powder analysis. The study of physicochemical properties will evaluate the purity of the drug. Ash value evaluates the presence of impurities like silicates, oxalates and carbonates. In this study the percentage of ash soluble and insoluble values are low and hence less in the associated impurities with the drug. Moisture content present in the plant material suggests the possibility of microbial attack and to bring undesirable changes in the drug. Here, the moisture content is 0.47% which suggests the less possibility of microbial attack during drug storage. Quantitatively the amount of drug extracted in the respective solvents will suggest the presence of polar and the non-polar phytoconstituents. In this research the ethanol extractive value is more indicating the presence of polar rich phytoconstituent. Screening of AS by HPTLC reports the presence of various phytoconstituents [23]. In line with this the present research reports secondary metabolites like phenols, alkaloids, steroids, glycosides, flavonoids, triterpenes in ethanol extract followed by chloroform extract. Whereas petroleum ether extract did not show any significant result. Estimation of total phenolics and total flavonoids from the methanolic extract was recorded by Ultra-violet spectrophotometry [24]. In this study a more sensitive method for estimating total phenolics and total flavonoids in  $\mu\text{g}$  is done by RP-HPLC method. The presence of these phenolics and flavonoids phytoconstituents is responsible for their anti-oxidative properties. Therefore, further the study is subjected to evaluate the anti-oxidant property. Reactive oxygen species in the cell causes oxidative damage and needs to be scavenged by anti-oxidants. The potency of clinical importance of plant is to evaluate its anti-oxidant activity. In vivo anti-oxidant activity of ethanol leaf extract of AS is reported [5]. Here, invitro models for anti-oxidant activity is used to study the anti-oxidant activity of petroleum ether, chloroform and ethanol extract of AS against the standard drug Ascorbic acid. Petroleum ether extract did not show any significance inhibition in the selected concentration range which is justified by its behaviour in not obeying the linearity rule. Chloroform and ethanol extracts showed good anti-oxidant activity among which ethanol extract is much more significant. The study reveals potent capacity of ethanol extract of whole plant as anti-oxidant drug which provides insights of its application and importance in curing diseases.

## CONCLUSION

The present study on pharmacognostic and phytochemical evaluation of *Andrographis serphyllifolia* (Rottl. ex Vahl.) Wt. is a step wise study which helps in making a monograph and standardising the medicinal plant. The parameters considered in this study are distinctive to authenticate the drug and can be considered to include as standards in Indian Pharmacopoeia.

## REFERENCES

1. Kumar V, Asija. Agrobiosis Biodiversity Conservation in Biodiversity-Principles and Conservation, India, Jodhpur. 2000.
2. Chopra RN, Nayar SL, Chopra IC. Glossary of Indian Medicinal Plants, PID, CSIR, New Delhi, 1992, 226.
3. Govindhachari TR, Parthasarathy PC, Pai BR, Kalyanaraman PS. Chemical investigation of *Andrographis serphyllifolia*: Isolation and structure of serphyllin, A new Flavone. *Tetrahedron* 1968; 24:7027-7031.
4. Sekhar J, Penchala PG, Sudarsanam G, Prasad GP. Ethnic information on treatments for snake bites in Kadapa district of Andhra Pradesh. *Life sciences Leaflets* 2011; 12: 368 -375.
5. Sanjeevaiah N, Jithan A. Pharmacological screening of *A. serpyllifolia* For Antidiabetic Activity. *Intern J of Advances in Pharma* 2013; 2: 2277-4688.
6. Deepa VS, Kumar PS, Vadivukkarasi B, Tilton F. Molecular Docking Studies On Selected Phytocompounds From Different *Andrographis* Sp Against Ppar- $\Gamma$  And C/Ebp-A Receptors For Type-2-Diabetes. *Asian J of Pharma and Clinical Research* 2013; 6:196-199.
7. Kandati V, Govardhan P, Reddy CS, Nath AR, Reddy RR. In-vitro and in-vivo anti-inflammatory activity of *A. serpyllifolia* (Rottl. E. Vahl.) Wt. *Inter Current Pharma J* 2012; 1: 199-204.
8. Sathisha UV, Smitha J, Shylaja MD. Antiproliferative, Antioxidant and Cyto/DNA Protective Properties in *Andrographis serpyllifolia*: Role of Andrographolide and Phenolic Acids. *Journal of Complementary and Integrative Medicine* 2007; 6: 1553-3840.
9. Chelluboina B, Manga K. Hypolipidemic activity of *Andrographis serpyllifolia* Wt.Ic. *Pharm Res* 2010; 3:769-770.

10. Ravishankar KB, Ganga R, Appala R, Chandralekha G, Vinod K. Antimicrobial and Anthelmintic activity of *Andrographis serpyllifolia* root extract. *International Journal Chem Sci* 2007; 5:1145-1149.
11. Damu AG, Jayaprakasam B, Gunasekar D, Blond A, Bodo B. Two acylated flavone glucosides from *A. serpyllifolia*. *Phytochem* 1999; 52:147-151.
12. Anonymous. *Indian pharmacopoeia*. 2<sup>nd</sup> ed. New Delhi: Government of India Publication; 1966, 367-370.
13. Khandelwal KR. *Practical Pharmacognosy: Techniques and Experiments*. 13<sup>th</sup> ed. Pune: Nirali Prakashan; 2005, 149-156.
14. Kokate CK. *Practical Pharmacognosy*. 4<sup>th</sup> ed. New Delhi: Vallabh Prakashan; 1994.
15. Chase CR, Pratt RJ. Fluorescence of powdered vegetable drugs with particular reference to the development of a system of identification. *Journal of American Pharmaceutical Association* 38 1949; 324-331.
16. Harbone JJ. *Phytochemical Methods: A Guide to Modern Techniques of Plant Analysis*. 2<sup>nd</sup> ed. New York: Chapman and Hall; 1984. p. 85-4.
17. Trease GE, Evans WC. *Pharmacognosy*. 13<sup>th</sup> ed. New Delhi: ELBS Publication; 1989. p. 171.
18. Potawale SE, Pawar PD, Gabhe SY, Mahadik KR. A validated isocratic RP-HPLC method for concurrent estimation of gymnemagenin, gallic acid and glycyrrhetic acid in polyherbal formulation. *Int J Pharm Pharm Sci* 2014;6:488-492.
19. Ang LF, Yam MF, Fung YT, Kiang PK, Darwin Y. HPLC method for simultaneous quantitative detection of quercetin and curcuminoids in traditional Chinese medicines. *J Pharmacopuncture* 2014; 17: 36-49.
20. Ohkawa H, Ohishi N, Yagi K. Assay for lipid peroxides in animal tissues by thiobarbituric acid reaction. *Anal Biochem* 1979; 95:351-8.
21. Cuendet M, Hostettman K, Potterat O. Iridoid glucosides with free radical scavenging properties from *Fagraea blumei*. *Helv Chim Acta* 1997; 80: 1144-52.
22. Garrat DC. *The quantitative analysis of drug Japan*. Vol. 3. Japan: Chapman and Hall; 1964. p. 456-8.
23. Rao CV, Lubna A, Shyam SG. Phytochemical And Pharmacological Review on *Andrographis serpyllifolia*: Potential Herbal Cure-All Mintage. *Journal of Pharmaceutical and Medical Sciences* 2014; 3(Suppl 3).
24. Krishnaswamy S, Kushalappa BA. Systematic Review *Andrographis serpyllifolia* (Rottler ex Vahl) Wight: An Ethno-Pharmaco-Botanical Perspective. *Pharmacogn J*. 2018; 10: 14-26.

## Study of Antioxidant Activity, Phenolic and Flavonoid Contents from Citrus Sinensis and Citrus Reticulata Peel Extracts

Chandanshiv Suchita Laxmanrao and Wadikar Madhukar Subhash

Department of Botany, R.B. Attal Arts, Science and Commerce College Georai-431127(M.S.)

### ABSTRACT

The aim of present study was to evaluate the phytochemical and in vitro antioxidant properties of Citrus fruit rind extract. Methanolic extracts of two commercially available citrus fruits i.e. *C. sinensis* & *C. reticulata* peels were investigated for their antioxidant activity by DPPH method. % radical scavenging activity of *C. sinensis* & *C. reticulata* is found to be 80.96% & 83.44% which corresponds to 56.22 µg/ml & 58.38 µg/ml. Total phenolic content (TPC) of the citrus spp. samples (based on Folin-Ciocalteu method) is found to be 13.46% & 25.59% gallic acid equivalent (GAE) respectively and total flavonoid content (TFC) (based on aluminium chloride colorimetric method) of sample was found to be 2.93% & 4.59% Quercetin equivalent (QE) respectively. The present study provides evidence that both Citrus fruit peels are potential source of natural antioxidant.

Keywords: Antioxidant activity; phenolic content; flavonoids content; citrus fruit; peels.

### INTRODUCTION

Citrus is a genus of flowering plants in the family Rutaceae (orange family). Citrus peels are primary byproducts during processing discarded as wastes and represent an environmental problem. Peels have biologically active compounds including natural antioxidants; and can be used as cheap source of functional ingredients and food additives. It is now widely known that vitamin C (ascorbic acid) and carotenoids are found in abundance in citrus fruits (Dhuique-Mayer *et al.*, 2005), which play an important role primarily in causing resistance against many diseases. Recently, the focus has shifted to phenolic compounds derived from different fruits including citrus. For example, some studies have suggested that in addition to vitamin C and carotenoids, phenolic compounds play an integral role in total antioxidant capacity of citrus fruits (Gorinstein *et al.*, 2004). The major phenolic compounds detected in different citrus fruits are categorized as flavonoids and phenolic acids (Balasundram *et al.*, 2006). Citrus byproducts also represent a rich source of naturally occurring flavonoids (Horowitz, 1961). The peel which represents almost one half of the fruit mass contains the highest concentrations of flavonoids in the Citrus fruit (Anagnostopoulou *et al.*, 2006; Manthley and Grohmann, 1996 and 2001). Different studies have reported the health benefits of Citrus fruits in terms of their antioxidant capacity. The aim of carrying out this study was to explore the antioxidant potential and quantify the bioactive compounds, namely phenolic and flavonoid in the peel from Sweet orange and orange.

### MATERIALS AND METHODS:-

**Plant Material:-** Fruits of *Citrus sinensis* and *Citrus reticulata* were collected at the ripening stages from local market of Aurangabad (M.S.). Fruits peels were dried at room temperature and coarsely grinded. Dried powdered samples were extracted at room temperature by percolation with methanol. All extracts were concentrated over a rotary vacuum evaporator until a solid extract sample was obtained. The resulting crude extract was freeze-dried.

### Determination of Total Phenol Content

Total phenolic compound contents were determined by the Folin-Ciocalteu method

(Ebrahimzaded *et al.*, 2008a,b; Nabavi *et al.*, 2008). The extract samples (0.5 ml of different dilutions) were mixed with Folin Ciocalteu reagent (5 ml, 1:10 diluted with distilled water) for 5 min and aqueous Na<sub>2</sub>CO<sub>3</sub> (4 ml, 1 M) were then added. The mixture was allowed to stand for 15 min and the phenols were determined by colorimetry at 765 nm. The standard curve was prepared by 0, 50, 100, 150, 200, and 250 mg ml<sup>-1</sup> solutions of gallic acid in methanol: water (50:50, v/v). Total phenol values are expressed in terms of gallic acid equivalent (mg g<sup>-1</sup> of dry mass), which is a common reference compound.

### Determination of Total Flavonoid Content

Colorimetric aluminum chloride method was used for flavonoid determination (Ebrahimzaded *et al.*, 2008a, b; Nabavi *et al.*, 2008). Briefly, 0.5 mL solution of each plant extracts in methanol were separately mixed with 1.5 mL of methanol, 0.1 mL of 10% aluminum chloride, 0.1 mL of 1 M potassium acetate, and 2.8 mL of distilled water, and left at room temperature for 30 minutes. The absorbance of the reaction mixture was measured at 415 nm with a double beam Perkin Elmer UV/Visible spectrophotometer (USA). Total flavonoid

contents were calculated as quercetin from a calibration curve. The calibration curve was prepared by preparing quercetin

Solutions at concentrations 12.5 to 100 mg ml<sup>-1</sup> in methanol.

#### DPPH Radical- Scavenging Activity

The stable 1, 1-diphenyl-2-picryl hydrazyl radical (DPPH) was used for determination of free radical-scavenging activity of the extracts (Ebrahimzadeh *et al.*, 2008a, 2008b, 2008c). Different concentrations of each extract were added, at an equal volume, to methanolic solution of DPPH (100 µM). After 15 min at room temperature, the absorbance was recorded at 517 nm. The experiment was repeated for three times. Vitamine C, BHA and quercetin were used as standard controls. IC<sub>50</sub> values denote the concentration of sample, which is required to scavenge 50% of DPPH free radicals.

#### STATISTICAL ANALYSIS

Experimental results are expressed as means ± SD. All measurements were replicated three times. The data were analyzed by an analysis of variance ( $p < 0.05$ ) and the means separated by Duncan's multiple range test. The IC<sub>50</sub> values were calculated from linear regression analysis.

#### RESULTS AND DISCUSSION

##### Total Phenolic Content

Total phenol compounds, as determined by folin Ciocalteu method, are reported as gallic acid equivalents by reference to standard curve ( $y = 0.0034x$ ,  $r^2 = 0.987$ ). The amount of total phenolic contents (TPC) was present in varying concentrations in the different extracts of *Citrus* fruits. The results were expressed as the number of equivalents of gallic acid (µg/mg of extract) and were found to be highest in *Citrus reticulata* 25.59% and low in (*Citrus sinensis*) 13.46%.

##### Total Flavonoids Content

Total flavonoid content (TFC) of *C. sinensis* and *C. reticulata* was found to be 2.93% and 4.59% Quercetin equivalent (QE) respectively. The result showed that *C. reticulata* having high percentage of Flavonoid content than *C. sinensis*.

##### Antioxidant Activity

##### DPPH Free Radical- Scavenging Activity

In evaluating the radical-scavenging potential of a Citrus fruit peel Samples; the DPPH assay is frequently used. Usually, a high DPPH scavenging activity reflects high levels of antioxidant potential. The DPPH radical-scavenging activity of the Citrus fruit i.e. Citrus reticulata 83.44% exhibited the highest DPPH radical-scavenging activity, followed by C. sinensis 80.96%. It has been reported that the antioxidant potential of Citrus fruit is directly proportional to the amount of phenolic acids and flavonoids present G. Beretta, et al. (2005).

The results of TAC revealed that all Citrus fruit extracts under the study possess significant antioxidant potential. The results were compared with the standard curve of ascorbic acid and were expressed in terms of the equivalence of ascorbic acid in µg/ml of extract. From the results, it was found that C. reticulata extracts showed the maximum content of total antioxidants (83.44) which corresponds to 58.4 µg/ml, followed by C. sinensis (80.96) which is corresponding to 56.2 µg/ml. The model of scavenging the stable DPPH radical is a widely used method to evaluate the free radical scavenging ability of various samples (Lee et al., 2003). It was found that the radical-scavenging activities of all the extracts increased with increasing concentration. The high phenol and flavonoids contents of Peels of C. reticulata may cause high antioxidant activity. Phenols and polyphenolic compounds, such as flavonoids, are widely found in food products derived from plant sources, and they have been shown to possess significant antioxidant activities (van Acker et al., 1996). The correlation between total phenol contents and antioxidant activity has been widely studied in different foodstuffs such as fruit and vegetables (Klimczak et al., 2007; Kiselova et al., 2006; Jayaprakasha et al., 2008; Kedage et al., 2007). As reported, antioxidant activity of Kamran Ghasemi et al. Pak. J. Pharm. Sci., Vol.22, No.3, July 2009, pp.277-281 279 fruits and vegetables significantly increases with the presence of high concentration of total polyphenol content. In the present study, the correlation between total phenolic and flavonoids contents and radical scavenging activity of methanolic extracts from two citrus species were analyzed.

#### REFERENCES

1. Anagnostopoulou MA, Kefalas P, Papageorgiou VP, Assimopoulou AN and Boskou D (2006). Radical scavenging activity of various extracts and fractions of sweet orange peel (*Citrus sinensis*). Food Chem., 94: 19-25.

2. Cotellet N, Bernier JL, Cateau JP, Pommery J, Wallet JC and Gaydou EM (1996). Antioxidant properties of hydroxylflavones. *Free Radic Biol Med.*, 20(1): 35-43
3. Calabro ML, Galtieri V, Cutroneo P, Tommasini S, Ficarra P and Ficarra R (2004). Study of the extraction procedure by experimental design and validation of a LC method for determination of flavonoids in Citrus bergamia juice. *J Pharm and Biomed Anal.*, 35: 349-363.
4. Dean SG and Svoboda KP (1989). Antimicrobial activity of summer savory (*Satureja hortensis* L.) essential oil and its constituents. *J. Hort. Sci.* 64: 205-210.
5. Di Majo D, Giammanco M, La Guardia M, Tripoli E, Giammanco S and Finotti E (2005). Flavanones in Citrus fruit: Structure-antioxidant activity relationships. *Food Res. Intern.*, 38: 1161-1166.
6. Ebrahimzadeh MA, Hosseinimehr SJ and Gayekhloo MR (2004). Measuring and comparison of vitamin C content in citrus fruits: introduction of native variety, *Chemistry: An Indian Journal*, 1(9): 650-652.
7. Ebrahimzadeh MA, Hosseinimehr SJ, Hamidinia A and Jafari M (2008a). Antioxidant and free radical scavenging activity of Feijoa sellowiana fruits peel and leaves. *Pharmacology online*, 1: 7-14.
8. Ebrahimzadeh MA, Pourmorad F and Bekhradnia AR (2008b). Iron chelating activity screening, phenol and flavonoid content of some medicinal plants from Iran. *Afr. J. Biotechnol.*, 32: 43-49.
9. C. A. Rice-Evans, N. J. Miller, and G. Paganga, "Structure antioxidant activity relationships of flavonoids and phenolic acids," *Free Radical Biology and Medicine*, vol. 20, no. 7, pp. 933-956, 1996.
10. N. Ramarathnam, H. Ochi, and M. Takeuchi, "Antioxidant defense system in vegetable extracts," in *Natural Antioxidants, Chemistry, Health Effects and Applications*, F. Shahidi, Ed., pp. 76-87, AOCS Press, Champaign, Ill, USA, 1997.
11. D. Marinova, F. Ribarova, and M. Atanassova, "Total phenolic and total flavonoids in Bulgarian fruits and vegetables," *Journal of the University of Chemical Technology and Metallurgy*, vol. 40, no. 3, pp. 255-260, 2005.
12. C. Chang, M. Yang, H. Wen, and J. Chern, "Estimation of total flavonoid content in propolis by two complementary colorimetric methods," *Journal of Food and Drug Analysis*, vol. 10, no. 3, pp. 178-182, 2002.
13. F. Pourmorad, S. J. Hosseinimehr, and N. Shahabimajid, "Antioxidant activity, phenol and flavonoid contents of some selected Iranian medicinal plants," *African Journal of Biotechnology*, vol. 5, no. 11, pp. 1142-1145, 2006.
14. G. Miliauskas, P. R. Venskutonis, and T. A. van Beek, "Screening of radical scavenging activity of some medicinal and aromatic plant extracts," *Food Chemistry*, vol. 85, no. 2, pp. 231-237, 2004.
15. Z. Cheng, J. Moore, and L. Yu, "High-throughput relative DPPH radical scavenging capacity assay," *Journal of Agricultural and Food Chemistry*, vol. 54, no. 20, pp. 7429-7436, 2006.
16. Antioxidant and free radical of the total antioxidant activity of fruits and scavenging activity of Feijoa sellowiana fruits peel vegetables by a liposome assay. *J. Agric. Food and leaves. Pharmacology online*, 1: 7-14. *Chem.*, 51: 1486-93.
17. Schieber, A., F. C. Stintzing and R. Carle, 2001. Bast, 2011. Structural aspects of antioxidant activity Byproducts of plant food processing as a source of flavanoids. *Free Radic. Biol. Med.*, 35: 331-342.
18. Functional compounds-recent developments. Trends 20. Prashani, M.E., T.P. Geun, D.L. Young, K. Sejae, J. in *Food Science and Technology*, 12: 401-413. Sang and L. Jehee, 2005. *J. Food lipids*, 12: 34.

## Phytoplankton and Zooplankton Diversity of Stagnant Water of Masoli Dam from Gangakhed Tahasil District Parbhani

Anirudha Budrukar<sup>1</sup> and Sabiha V Syed<sup>2</sup>

<sup>1</sup>Department of Zoology, R.B. Atal Arts, Science & Commerce College, Georai

<sup>2</sup>Department of Botany, Shri Shivaji College, Parbhani

### ABSTRACT

Phytoplanktons plays an important role as primary producer in food web of aquatic ecosystem. These are widely present in streams, rivers, lakes and stagnant water. If the pure water contains all physicochemical factors at their optimum level then there will be maximum production of phytoplanktons (Sinha & Srivastava 1991). Current paper deals with study of phytoplankton diversity from stagnant water from Masoli dam area from Gangakhed tahasil district Parbhani. During this study members of phytoplanktons belonging to Chlorophyceae, Cyanophyceae, Bacillariophyceae and Euglenophyceae were recorded. The zooplanktons recorded are Rotife, Copepod, Ostracoderm and Cladocera.

Keywords: Phytoplanktons, zooplanktons, Masolidam, Gangakhed tahasil.

### INTRODUCTION

Algae are commonly present in water bodies and phytoplanktons are the minute, nonmotile forms suspended in water bodies. Phytoplanktons are primary producer, basis of whole autotrophic food web of aquatic ecosystem. They are also used as bio indicators of aquatic ecosystem (Beaugrand et.al.2000). The aim of current investigation is to know the phytoplankton and zoo plankton diversity from masoli damwater. Masoli dam is earthfill dam constructed on Masoli river near Gangakhed tahasil of Parbhani district located between 18.89°N & 76.74°E. The dam was constructed for irrigation purpose and has water storage capacity of 8176.23 Cu mi. It occupies surface area of 6970 km<sup>2</sup> (wikipedia-google net). Peoples of nearby area are utilizing this water for drinking, washing and for irrigation purpose. Phytoplankton study provides relevant information about the water quality and eutrophication and its effect on aquatic system. Keeping this view in mind the present study was carried out during academic year 2020-2021 to assess species richness and species diversity of phytoplanktons and zooplanktons from Masoli dam reservoir.

### MATERIAL AND METHODS

In present study plankton sampling was taken during academic year 2020-2021 at four different sites during summer, monsoon and winter seasons. Each sample was collected by filtering through plankton net and preserved in 4% formalin solution. The formalin fixed samples were centrifuged at 1500-2000rpm for 10 minutes. Phytoplanktons settled at the bottom were diluted and the individual plankton is counted under compound microscope. Phytoplanktons were measured and multiplied with dilution factors as given by Sedwick Rafter cell (Welch, 1948; APHA, 2005). Species diversity is calculated as per Ludwik and Reynold (1988). The zooplanktons were identified according to the guidelines given by Ward and Whipple (1958) and Battish (1958).

### RESULT AND DISCUSSION

Diversity of planktons and detailed microscopic study reveals that there are prominent 4 family members of phytoplanktons are reported belonging to family *Chlorophyceae* = 28%, family *Cyanophyceae* = 36%, family *Bacillariophyceae* = 6%, *Euglenophyceae* = 10% total Phytoplankton = 80%.

Phytoplanktons observed are –*Chlorrella sp.*, *Chlamydomonas sp.*, *Chara sp.*, *Oedogonium sp.*, *Spirogyra sp.*, *Volvox sp.* of *Chlorophyceae*. *Diatom sp.*, *Navicula sp.*, *Pinnularia sp.* of *Bacillariophyceae*. *Anabena sp.*, *Microcystis sp.*, *Nostoc sp.*, *Ocillatoria sp.* of *Cyanophyceae*. *Euglena sp.*, *Phacus sp.* and *Trachemonas sp.* of *Euglenophyceae* were present. The high phytoplankton population was observed during summer season as maximum decomposition occurs due to high temperature and water becomes nutrient rich as well as during summer water is stable leads to high phytoplankton population while monsoon water is diluted much due to rain results in minimum phytoplankton population. The Zooplanktons observed are *Rotifer*, *Copepod*, *Ostracoderm* and *Cladocera*. The present analysis and results shows that the rotifer dominancy. During the study the rotifer was 140 in no. / L at spot A, the copepods was 90 in no. / L at spot A, the ostracoderm in no. / L was 95 in no. / L at spot A, the cladocera was in no. / L 99

---

---

## CONCLUSION

Phytoplanktons belonging to Chlorophyceae were dominant in masoli water reservoir during study period indicate availability of optimum physicochemical factors for growth of chlorophyceae members as compare to Bacillariophyceae, Cyanophyceae and Euglinophyceae. During study zooplankton community shows that the rotifers are dominant in all season this shows that the water temperature increases in summer while optimal in winter and mansoon the photosynthetic activity is clear in summer the reservoir water is useful for fish cultural activity.

## REFERENCES

1. APHA: Standard methods for the estimation of water and waste waters. 21<sup>st</sup> Edn., Washington, D.C. USA (2005).
2. Anitha G. Kodarkar (2004): Studies on Macrobenthos Mir Ali lake Hyderabad A.P. J. Aqua. Biol. 19 (1) 68-69
3. Battish. S. K. (1992)-Freshwater zooplankton of India Oxford and IBH Pub. Co. PP 233 Ward H. B. and Whipple G. C. (1958)-Freshwater iology Mc. Graw Hill and Co. New York.
4. Chandrasekhar S.V.A. and Kodarkar.M.S. (1994): Biodiversity of zooplankton in Saroomsagar Lake, Hyderabad J. Aqua. Biol. 9 (1-2) 68-69
5. Prashant V. Patil and Anirudha M. Budrukkar (2019): Zooplanktonic analysis and aquatic pollution load of Vanjarwadi reservoir dist Beed
6. Ludwik ,J.A. and J.F.Reynolds : Statistical ecology a primer on methods and computing A Wiley-Interscience Publication. New York pp.1-337 (1998)
7. Sinha V.R.P., Srivastava H.C. (1991): Aquaculture productivity. Oxford IHB Publishing Co. Pvt. Ltd New Delhi.
8. Wetch, P.S: Limnology methods .McGraw book Co. Inc. New York (1948)



## Design and in-Silico Studies of 2-Hydroxy-5-((5-(Substituted Styryl) Isoxazol-3-Yl) Diazenyl) Benzoic Acids

Madhavi Kuchana\* and Divya Satyakala Korni

Institute of Pharmaceutical Technology, Sri Padmavati Mahila Visvavidyalayam, Women's University,  
Tirupati, Andhra Pradesh, India

### ABSTRACT

A series of novel substituted styryl isoxazole azo compounds, 2-hydroxy-5-((5-(substituted styryl)isoxazol-3-yl)diazenyl)benzoic acids, were devolved computationally. Molecular properties, drug likeness and bioactivity of all the designed compounds were estimated using Molinspiration Cheminformatics. The results indicated that all the title compounds followed Lipinski's rule of five and predicted as more active Kinase Inhibitors and Enzyme Inhibitors. All the compounds were allowed to dock against COX-1 (PDB ID: 1EQG), COX-2 (PDB ID: 3LN1) and 5-LOX (PDB ID: 3O8Y) enzymes using AutoDock 4.2 and evaluated the comparative efficacy of designed compounds in terms of docking performance. Few compounds were identified as dual inhibitors of COX and 5-LOX enzymes based on their low binding energy values. The present work gives an insight into the modification of molecules by varying substitution on phenyl ring of the styryl isoxazole moiety and the resultant effect on molecular properties, drug likeness, bioactivity and docking performance.

Keywords: Styryl isoxazole, 5-Amino salicylic acid, Drug likeness, Bioactivity, Molecular docking

### INTRODUCTION

The major function of NSAIDs is to block cyclooxygenase or prostaglandin synthase, preventing arachidonic acid from being converted to prostaglandins, prostacyclin and thromboxanes. However, evidence has been accumulated that inhibition of cyclooxygenase (COX) enzyme causes increased leukotriene production from arachidonic acid through 5-lipoxygenase (5-LOX) pathway. Identification of this resulted in development of novel dual inhibitors of COX and 5-LOX enzymes with the hope of producing safer analgesic and anti-inflammatory agents<sup>1</sup>.

Isoxazole, a five membered heterocycle with oxygen and nitrogen adjacent to each other, plays a significant role in the field of medicinal chemistry. Compounds with isoxazole nucleus are largely used as pharmacotherapeutics<sup>2</sup>. This nucleus along with substituted styryl group is likely to be more biologically active. Several substituted styryl isoxazoles were reported as novel dual inhibitors of COX and 5-LOX enzymes<sup>1</sup>. Recently, some isoxazole azo dyes were developed *in silico*. Among those newly designed isoxazole azo compounds, 2-hydroxy-5-((5-methylisoxazol-3-yl) diazenyl) benzoic acid was identified as lead molecule with better drug likeness properties by computational methods<sup>3</sup>. Prompted by this observation, it is aimed to design a series of styryl derivatives of isoxazole azo compounds (2-hydroxy-5-((5-(substituted styryl) isoxazol-3-yl) diazenyl) benzoic acids) and to predict the molecular properties, drug likeness and bioactivity using free online software. Further, it is aimed to perform molecular docking studies by selecting enzymes involved in the process of inflammation using AutoDock 4.2 software.

### MATERIALS AND METHODS

The software used for the *in silico* studies of 2-hydroxy-5-((5-(substituted styryl) isoxazol-3-yl) diazenyl) benzoic acids include:

- ChemDraw Ultra 12.0
- Molinspiration Cheminformatics
- AutoDock 4.2

ChemDraw Ultra 12.0 was used for the generation of chemical structure, IUPAC name and SMILES notation of the title compounds.

### Prediction of Molecular Properties and Bioactivity Score

Molinspiration Cheminformatics software was employed to obtain various molecular properties like molecular weight, Log P (octanol-water partition coefficient), hydrogen bond donors, hydrogen bond acceptors, number of rotatable bonds and topological polar surface area (TPSA) by theoretical calculations. The estimated physicochemical properties were used to evaluate the drug likeness properties of title compounds based on Lipinski's rule of five. This rule states that the molecular weight should be  $\leq 500$ , Log P value should be  $\leq 5$ ,

number of hydrogen bond donors should be  $\leq 5$  and number of hydrogen bond acceptors should be  $\leq 10$ . The Lipinski's rule of five used to predict the oral bioavailability of prospective lead or therapeutic compounds in drug design and development. TPSA, another very useful physicochemical parameter that gives information about the polarity of compounds, used to predict the transport properties of compounds such as intestinal absorption and blood brain barrier penetration. Molinspiration Cheminformatics was also used for the prediction of bioactivity scores as GPCR Ligands, Ion Channel Modulators, Kinase Inhibitors, Nuclear Receptor Ligands, Protease Inhibitors and Enzyme Inhibitors<sup>4</sup>.

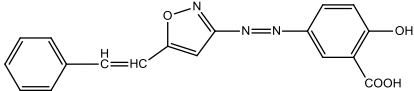
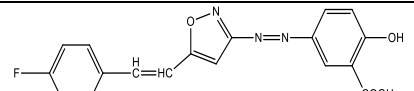
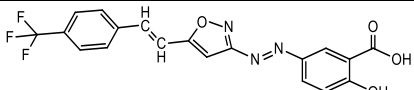
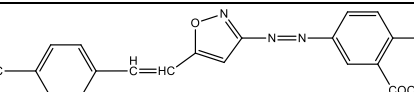
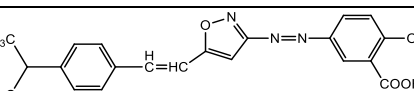
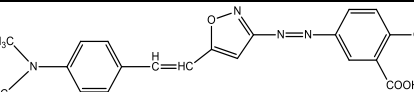
### Molecular Docking Studies

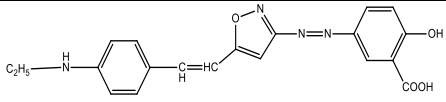
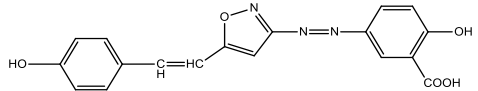
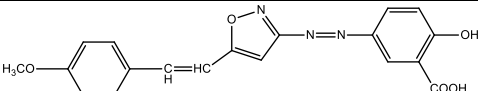
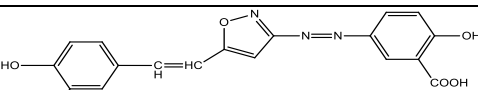
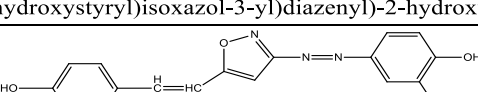
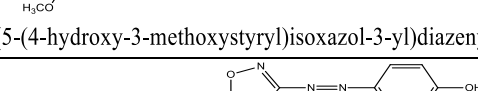
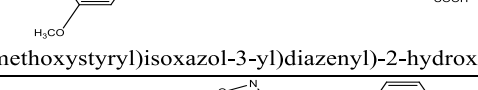
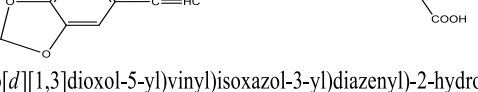
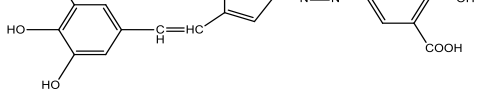
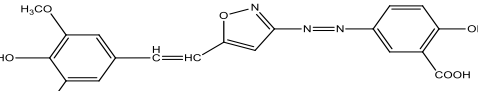
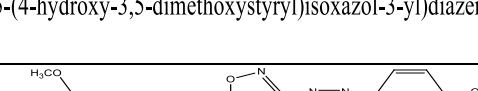
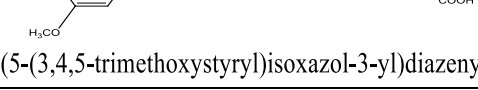
AutoDock 4.2 was used for molecular docking simulations employing Lamarckian genetic algorithm methodology<sup>5</sup>. Three dimensional coordinates of selected drug targets associated with inflammation were obtained in PDB format from the Research Collaboratory for Structural Bioinformatics Protein Data Bank (<https://www.rcsb.org>). The title compounds were drawn using ChemDraw Ultra 12.0. Three dimensional structures of compounds were generated followed by energy minimization using Chimera programme and saved the PDB format before submission for the docking. All the PDB files were converted to PDBQT files (extended PDB format) with AutoDock tools. Grid box was generated and saved the GPF (Grid Parameter File). Then docking was performed and saved the DPF (Dock Parameter File). The obtained GPF and DPF converted into log files to analyze docked conformation and viewed the best pose having lowest binding energy in Biovia Drug Discovery Studio.

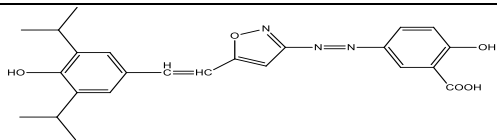
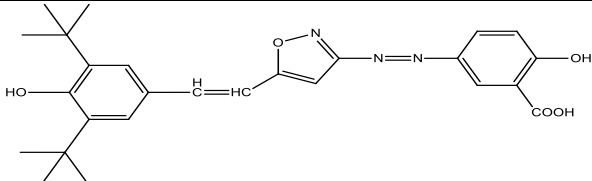
## RESULTS AND DISCUSSION

**Generation of Chemical Structure, IUPAC Name and SMILES Notation:** The chemical structure, IUPAC name and SMILES notation for 2-hydroxy-5-((5-(substituted styryl) isoxazol-3-yl) diazenyl) benzoic acids (compounds **1 - 20**) were generated by using ChemDraw Ultra 12.0. The data presented in Table 1.

**Table 1:** Chemical structure, IUPAC name and SMILES notation of 2-hydroxy-5-((5-(substituted styryl) isoxazol-3-yl) diazenyl) benzoic acids

S. No.	Chemical Structure with IUPAC name	SMILES notation
1	 2-hydroxy-5-((5-styrylisoxazol-3-yl)diazenyl)benzoic acid	<chem>OC(C=C1)=C(C(O)=O)C=C1N=NC2=NOC(C=CC3=CC=CC=C3)=C2</chem>
2	 5-((5-(4-fluorostyryl)isoxazol-3-yl)diazenyl)-2-hydroxybenzoic acid	<chem>OC(C=C1)=C(C(O)=O)C=C1N=NC2=NOC(C=CC3=CC=C(F)C=C3)=C2</chem>
3	 2-hydroxy-5-((5-(4-(trifluoromethyl)styryl)isoxazol-3-yl)diazenyl)benzoic acid	<chem>O=C(O)C1=CC(/N=N/C2=NO C(/C=C/C3=CC=C(C(F)(F)F)C=C3)=C2)=CC=C1O</chem>
4	 2-hydroxy-5-((5-(4-methylstyryl)isoxazol-3-yl)diazenyl)benzoic acid	<chem>OC(C=C1)=C(C(O)=O)C=C1N=NC2=NOC(C=CC3=CC=C(C)C=C3)=C2</chem>
5	 2-hydroxy-5-((5-(4-isopropylstyryl)isoxazol-3-yl)diazenyl)benzoic acid	<chem>OC(C=C1)=C(C(O)=O)C=C1N=NC2=NOC(C=CC3=CC=C(C(C)C)C=C3)=C2</chem>
6	 5-((5-(4-(dimethylamino)styryl)isoxazol-3-yl)diazenyl)-2-hydroxybenzoic acid	<chem>OC(C=C1)=C(C(O)=O)C=C1N=NC2=NOC(C=CC3=CC=C(N(C)C)C=C3)=C2</chem>

7	 5-((5-(4-(ethylamino)styryl)isoxazol-3-yl)diazenyl)-2-hydroxybenzoic acid	<chem>OC(C=C1)=C(C(O)=O)C=C1N=NC2=NOC(C=CC3=CC=C(NCC)C=C3)=C2</chem>
8	 2-hydroxy-5-((5-(4-hydroxystyryl)isoxazol-3-yl)diazenyl)benzoic acid	<chem>OC(C=C1)=C(C(O)=O)C=C1N=NC2=NOC(C=CC3=CC=C(O)C=C3)=C2</chem>
9	 2-hydroxy-5-((5-(4-methoxystyryl)isoxazol-3-yl)diazenyl)benzoic acid	<chem>OC(C=C1)=C(C(O)=O)C=C1N=NC2=NOC(C=CC3=CC=C(OC)C=C3)=C2</chem>
10	 5-((5-(3,4-dihydroxystyryl)isoxazol-3-yl)diazenyl)-2-hydroxybenzoic acid	<chem>OC(C=C1)=C(C(O)=O)C=C1N=NC2=NOC(C=CC3=CC=C(O)C(O)=C3)=C2</chem>
11	 2-hydroxy-5-((5-(4-hydroxy-3-methoxystyryl)isoxazol-3-yl)diazenyl)benzoic acid	<chem>OC(C=C1)=C(C(O)=O)C=C1N=NC2=NOC(C=CC3=CC=C(O)C(OC)=C3)=C2</chem>
12	 5-((5-(3,4-dimethoxystyryl)isoxazol-3-yl)diazenyl)-2-hydroxybenzoic acid	<chem>OC(C=C1)=C(C(O)=O)C=C1N=NC2=NOC(C=CC3=CC=C(OC)C(OC)=C3)=C2</chem>
13	 5-((5-(2-(benzo[d][1,3]dioxol-5-yl)vinyl)isoxazol-3-yl)diazenyl)-2-hydroxybenzoic acid	<chem>OC(C=C1)=C(C(O)=O)C=C1N=NC2=NOC(C=CC3=CC=C(OC4)C4=C3)=C2</chem>
14	 2-hydroxy-5-((5-(3,4,5-trihydroxystyryl)isoxazol-3-yl)diazenyl)benzoic acid	<chem>OC(C=C1)=C(C(O)=O)C=C1N=NC2=NOC(C=CC3=CC(O)=C(O)C(O)=C3)=C2</chem>
15	 2-hydroxy-5-((5-(4-hydroxy-3,5-dimethoxystyryl)isoxazol-3-yl)diazenyl)benzoic acid	<chem>OC(C=C1)=C(C(O)=O)C=C1N=NC2=NOC(C=CC3=CC(OC)=C(O)C(OC)=C3)=C2</chem>
16	 2-hydroxy-5-((5-(3,4,5-trimethoxystyryl)isoxazol-3-yl)diazenyl)benzoic acid	<chem>OC(C=C1)=C(C(O)=O)C=C1N=NC2=NOC(C=CC3=CC(OC)=C(OC)C(OC)=C3)=C2</chem>
17	 2-hydroxy-5-((5-(4-hydroxy-3,5-dimethylstyryl)isoxazol-3-yl)diazenyl)benzoic acid	<chem>OC(C=C1)=C(C(O)=O)C=C1N=NC2=NOC(C=CC3=CC(C)=C(O)C(C)=C3)=C2</chem>
18	 5-((5-(3,5-diethyl-4-hydroxystyryl)isoxazol-3-yl)diazenyl)-2-hydroxybenzoic acid	<chem>OC(C=C1)=C(C(O)=O)C=C1N=NC2=NOC(C=CC3=CC(CC)=C(O)C(CC)=C3)=C2</chem>

19	 <p>2-hydroxy-5-((5-(4-hydroxy-3,5-diisopropylstyryl)isoxazol-3-yl)diazenyl)benzoic acid</p>	<chem>OC(C=C1)=C(C(O)=O)C=C1N=NC2=NOC(C=CC3=CC(C(C)C)=C(O)C(C(C)C)=C3)=C2</chem>
20	 <p>5-((5-(3,5-di-tert-butyl-4-hydroxystyryl)isoxazol-3-yl)diazenyl)-2-hydroxybenzoic acid</p>	<chem>OC(C=C1)=C(C(O)=O)C=C1N=NC2=NOC(C=CC3=CC(C(C)C(C)C)=C(O)C(C(C)C(C)C)=C3)=C2</chem>

### Prediction of Molecular Properties and Bioactivity Scores of 2-Hydroxy-5-((5-(Substituted Styryl) Isoxazol-3-Yl) Diazenyl) Benzoic Acids:

Drug likeness properties of 2-hydroxy-5-((5-(substituted styryl)isoxazol-3-yl)diazenyl)benzoic acids were calculated through Molinspiration Cheminformatics and the results presented in Table 2. The molecular weight, number of hydrogen bond donors and the number of hydrogen bond acceptors were within the limit. Few compounds showed high log P value greater than five indicating high hydrophobicity. The number of violations found to be one for compounds **1, 2, 3, 4, 5, 6, 7, 9, 13, 17, 18, 19** and **20**. In general, an orally active drug has no more than one violation of Lipinski's rule<sup>6</sup>. Therefore, it can be inferred that all the designed compounds obeyed Lipinski's rule and exhibit drug likeness properties. The number of rotatable bonds of the compounds was found between 5 and 8 indicating their molecular flexibility, a key feature in determining ligand interaction with bio-macromolecular target. Further, the data revealed that all the compounds have high TPSA value than the precursor 2-hydroxy-5-((5-methylisoxazol-3-yl)diazenyl)benzoic acid<sup>3</sup>. This indicates that very large quantities of title compounds may accumulate in the colon after oral administration and cleave to an active drug 5-aminosalicylic acid by bacterial azoreductase of colonic bacteria.

**Table 2:** Molecular properties of 2-hydroxy-5-((5-(substituted styryl) isoxazol-3-yl) diazenyl) benzoic acids

S.No	miLog P	TPSA	n Atoms	M. Wt	n ON	n OHNH	n Violation	n rotb	volume
1	5.26	108.29	25	335.32	7	2	1	5	285.81
2	5.43	108.29	26	353.31	7	2	1	5	290.74
3	6.16	108.29	29	403.32	7	2	1	6	317.11
4	5.71	108.29	26	349.35	7	2	1	5	302.37
5	6.78	108.29	28	377.40	7	2	1	6	335.76
6	5.37	111.53	28	378.39	8	2	1	6	331.72
7	5.50	120.31	28	378.39	8	3	1	7	331.58
8	4.79	128.51	26	351.32	8	3	0	5	293.83
9	5.32	117.52	27	365.35	8	2	1	6	311.36
10	4.30	148.74	27	367.32	9	4	0	5	301.85
11	4.60	137.75	28	381.34	9	3	0	6	319.38
12	4.91	126.75	29	395.37	9	2	0	7	336.90
13	5.15	126.75	28	379.33	9	2	1	5	309.74
14	4.00	168.97	28	383.32	10	5	0	5	309.87
15	4.62	146.98	30	411.37	10	3	0	7	344.92
16	4.89	135.99	31	425.40	10	2	0	8	362.45
17	5.80	128.51	28	379.37	8	3	1	5	326.95
18	6.73	128.51	30	407.43	8	3	1	7	360.56
19	6.98	128.51	32	435.48	8	3	1	7	393.73
20	8.27	128.51	34	463.53	8	3	1	7	426.20

(MiLog P: n-octanol-water partition coefficient, TPSA: Topological Polar Surface Area, n Atoms: number of atom excluding hydrogens, M.Wt: Molecular weight, n ON: Hydrogen bond acceptors, n OHNH: Hydrogen bond donors, n Violations: Number of violations, n rotb: Number of rotatable bonds)

Bioactivity scores of 2-hydroxy-5-((5-(substituted styryl)isoxazol-3-yl)diazenyl)benzoic acids were assessed using Molinspiration Cheminformatics and the results presented in Table 3. The bioactivity scores greater than 0.00 are likely to be more active, values between -0.50 and 0.00 are expected to be moderately active and values less than -0.50 considered to be inactive<sup>7</sup>. All the compounds were active as Enzyme Inhibitors with bioactivity scores more than 0.00. Except few, all the compounds were more active as Kinase Inhibitors and GPCR Ligands. Among the series, only five compounds were more active and all other compounds were moderately active as Ion Channel Modulators. All the designed compounds were moderately active as Protease Inhibitors and Nuclear Receptor Ligands. It has been observed that bioactivity scores of the title compounds were more than 2-hydroxy-5-((5-methylisoxazol-3-yl) diazenyl) benzoic acid<sup>3</sup>. This indicates that the higher bioactivity of title compounds may be due to introduction of substituted styryl group on isoxazole azo compound.

**Table 3:** Bioactivity scores of 2-hydroxy-5-((5-(substituted styryl) isoxazol-3-yl) diazenyl) benzoic acids

S.No.	GPCR Ligand	Ion Channel Modulator	Kinase Inhibitor	Nuclear Receptor Ligand	Protease Inhibitor	Enzyme Inhibitor
1	0.04	0.00	0.08	-0.35	-0.17	0.07
2	0.04	-0.01	0.10	-0.32	-0.20	0.05
3	0.09	0.07	0.12	-0.18	-0.13	0.06
4	-0.01	-0.07	0.03	-0.36	-0.23	0.01
5	0.03	-0.01	0.03	-0.27	-0.17	0.06
6	0.04	-0.02	0.09	-0.29	-0.18	0.06
7	0.04	-0.03	0.09	-0.36	-0.12	0.05
8	0.06	0.02	0.10	-0.29	-0.16	0.09
9	-0.00	-0.06	0.04	-0.35	-0.21	0.03
10	0.04	-0.00	0.07	-0.31	-0.18	0.08
11	-0.00	-0.07	0.05	-0.36	-0.24	0.03
12	-0.01	-0.07	0.03	-0.35	-0.23	0.02
13	0.03	-0.07	0.01	-0.39	-0.21	0.04
14	0.03	-0.00	0.09	-0.31	-0.17	0.10
15	-0.03	-0.07	0.05	-0.36	-0.22	0.04
16	-0.03	-0.08	0.03	-0.38	-0.24	0.01
17	0.00	-0.06	0.03	-0.27	-0.19	0.04
18	0.05	0.01	-0.00	-0.22	-0.15	0.08
19	0.03	-0.01	-0.02	-0.20	-0.16	0.08
20	0.05	0.05	0.02	-0.13	-0.14	0.10

#### Molecular docking Studies of 2-hydroxy-5-((5-(substituted styryl) isoxazol-3-yl) diazenyl) benzoic acids:

The macromolecular targets associated with inflammation cascade such as COX-1 (PDB ID: 1EQG), COX-2 (PDB ID: 3LN1) and 5-LOX (PDB ID: 3O8Y) enzymes were selected for *in silico* study. COX-1 enzyme is responsible for maintaining gastric and renal integrity and COX-2 is an inducible enzyme responsible for the biosynthesis of prostaglandins, causing inflammation and pain<sup>8</sup>. 5-LOX enzyme plays a major role in production of proinflammatory leukotrienes from arachidonic acid. Increased leukotriene formation was also observed on inhibition of prostaglandin biosynthesis. Therefore, discovery of novel dual inhibitors of COX and 5-LOX for the treatment of inflammation emerged as beneficial approach<sup>1</sup>.

AutoDock 4.2 was used for predicting the interaction of title compounds with bio-macromolecular targets. The docking results portrayed in Table 4. Evaluation of docking results revealed that the compounds **4**, **5**, **6**, and **12** to **20** have low binding energy values for the COX-2 when compared to COX-1. This indicates good binding affinity of above compounds with COX-2 enzyme leading to its inhibition. Among the mentioned active ligands which inhibit COX-2 enzyme, compounds **20**, **13**, **18**, **6**, **5** and **17** showed good binding affinity with 5-LOX. Hence, it can be suggested that these molecules may act as dual inhibitors of COX and 5-LOX enzymes.

**Table 4:** Docking scores of 2-hydroxy-5-((5-(substituted styryl) isoxazol-3-yl) diazenyl) benzoic acids, Ibuprofen, Celecoxib and Licofelone

S.No.	Compound Code	Docking Score (kcal/mol)		
		TARGET: COX-1 PDB ID: 1EQG	TARGET: COX-2 PDB ID: 3LN1	TARGET: 5-LOX PDB ID: 3O8Y
1	C-1	-9.28	-8.53	-4.89

2	C-2	-8.47	-8.38	-4.42
3	C-3	-8.72	-8.63	-5.04
4	C-4	-8.79	-8.98	-4.81
5	C-5	-9.15	-9.61	-5.14
6	C-6	-8.82	-9.13	-4.84
7	C-7	-9.66	-8.90	-5.03
8	C-8	-9.73	-9.41	-4.73
9	C-9	-9.50	-8.72	-4.46
10	C-10	-8.59	-8.79	-4.32
11	C-11	-8.53	-7.93	-3.29
12	C-12	-6.67	-9.27	-3.69
13	C-13	-8.37	-9.16	-4.81
14	C-14	-5.45	-8.26	-3.88
15	C-15	-4.23	-7.28	-3.78
16	C-16	-6.01	-7.93	-3.97
17	C-17	-7.03	-8.76	-5.48
18	C-18	-6.59	-9.00	-4.84
19	C-19	-7.72	-8.67	-3.96
20	C-20	-8.17	-9.54	-4.14
21	Standard Drug	-6.95	-10.60	-6.57
		Ibuprofen	Celecoxib	Licofelone

## CONCLUSION

A series of 2-hydroxy-5-((5-(substituted styryl)isoxazol-3-yl)diazanyl)benzoic acids were developed *in silico*. All the designed styryl isoxazole azo compounds satisfied the Lipinski's rule and displayed drug likeness. Most of the compounds found to have low gastrointestinal absorption. As a result, very large quantities of these compounds may accumulate in the colon after oral administration and cleave to an active drug 5-aminosalicylic acid by bacterial azoreductase of colonic bacteria. Therefore, these compounds can be developed as drugs for the treatment of inflammatory bowel disease. In the present study, all the compounds were identified as more active Kinase Inhibitors and Enzyme Inhibitors. The *in silico* anti-inflammatory properties of title compounds were assessed by molecular docking studies selecting COX-1 (PDB ID: 1EQG), COX-2 (PDB ID: 3LN1) and 5-LOX (PDB ID: 3O8Y) enzymes. Among all, few compounds were identified as dual inhibitors of COX and 5-LOX enzymes. However, further studies are needed to confirm their *in vivo* anti-inflammatory properties through dual inhibition of COX and 5-LOX enzymes.

## CONFLICT OF INTEREST

The authors have no conflict of interest.

## REFERENCES

1. Flynn DL, Belliotti TR, Boctor AM, Connor DT, Kostlan CR, Nies DE, Ortwine DF, Schrier DJ, and Sircar JC. Styrylpyrazoles, styrylisoxazoles, and styrylisothiazoles. Novel 5-lipoxygenase and cyclooxygenase inhibitors. *Journal of Medicinal Chemistry*. 1991; 34 (2):518-525. <https://doi.org/10.1021/jm00106a006>
2. Agrawal N, Mishra, P. The synthetic and therapeutic expedition of isoxazole and its analogs. *Medicinal Chemistry Research*. 2018; 27:1309–1344. <https://doi.org/10.1007/s00044-018-2152-6>
3. Kuchana M, Kaparathi K. Prediction of physicochemical properties, bioactivity, pharmacokinetics, drug-likeness and synthetic accessibility of phenyl and isoxazole azo dyes. *Bioscience Biotechnology Research Communications (Special Issue)*. 2021; 14(5):301-305. <https://doi.org/10.21786/bbrc/14.5/53>
4. Kuchana M, Pulavarthi M, Potthuri S, Manduri V and Jaggarapu VD. In-silico study of molecular properties, bioactivity and toxicity of 2-(substituted benzylidene) succinic acids and some selected anti-inflammatory drugs. *International Journal of Pharmaceutical Sciences and Drug Research*, 2020; 12(4):353-359. <https://doi.org/10.25004/IJPSDR.2020.120407>
5. Rizvi SM, Shakil S, Haneef M. A simple click by click protocol to perform docking: AutoDock 4.2 made easy for non-bioinformaticians. *EXCLI Journal*. 2013; 12:831-57. PMID: 26648810; PMCID: PMC4669947.

6. Lipinski CA, Lombardo F, Dominy BW, Feeney PJ. Experimental and computational approaches to estimate solubility and permeability in drug discovery and development settings. *Advanced Drug Delivery Reviews*. 2001; 46 (1–3):3–26. [https://doi.org/10.1016/s0169-409x\(00\)00129-0](https://doi.org/10.1016/s0169-409x(00)00129-0)
7. Verma A. Lead finding from *Phyllanthus debelis* with hepatoprotective potential. *Asian Pacific Journal of Tropical Biomedicine*. 2012; 2(3):S1735-S1737. [https://doi.org/10.1016/S2221-1691\(12\)60486-9](https://doi.org/10.1016/S2221-1691(12)60486-9)
8. Vane JR, Bakhle YS, Botting RM. Cyclooxygenases 1 and 2. *Annual Review of Pharmacology and Toxicology*. 1998; 38:97-120. <https://doi.org/10.1146/annurev.pharmtox.38.1.97>

## A Facial & Efficient Synthesis, Characterization of Alkyl and Aryl Substituted Bis 1, 3, 4-Oxadiazol

M. N. Gulhane

Department of Chemistry, Arts and Science College, RTMN University, Pulgaon, District-Wardha 442302  
(M.S) India

### ABSTRACT

Substituted, bis 1, 3, 4 Oxadiazole have been achieved by the cyclization of bis – (N-aryl/alkyl) thiocarbamido sebacic acid diamide with molecular iodine in presence of alkaline ethanolic medium. There structure of all these synthesized compounds were established on the basis of chemical transformation, IR, 1H NMR mass spectral and elemental analysis.

Keywords: Oxadiazol, 1, 3, 4 Oxadiazol derivatives, Oxygen heterocyclic compound, spectroscopic study.

### INTRODUCTION

Oxadiazoles are the heterocyclic compounds contain one oxygen and two nitrogen atoms are very active compound due to their important act in practical uses in studies of preparation of drugs and medicine. [1,2] possessing a diversity of useful biological effect[3].Several method have been reported in the literature for the synthesis 1,3,4 Oxadiazoles [4-11].They are also used for the treatment of HIV-1 infection [12-13].The compound possessing 1,3,4oxadiazoles ring system are reported [14-20] to show a broad spectrum of biological properties like analgesic and anti-inflammatory, antibacterial and antifungal activities. In the present paper the commonly used synthetic route for 1,3,4 oxadiazoles has been carried out by the action of I<sub>2</sub>/KI on bis-(aryl/alkyl) sebacic acid diamide.

### Experimental Section

All chemicals were of analytical grade and uses directly. All melting point were determined in PMP-DM Scientific melting point apparatus and are uncorrected. The purity of compound was checked on silica gel-G plates by thin layer chromatography. The carbon and hydrogen analysis was carried out on Carlo-Erba-1106analyzer, Nitrogen estimation was carried out on Colman -N-analyzer, The IR spectra were recorded on a perkin- Elmer-577 model spectrophotometer using KBr pellets ,1HNMR spectra were acquired on d broker Avance -2 model spectrophotometer using CDCl<sub>3</sub> as a solvent and TMS as an internal reference.

### MATERIAL AND METHODOLOGY

#### Bis-(N-aryl/Alkyl Thiocarbamido Sebacic acid Diamide (2) :

Compound bis N-aryl /alkyl thicarbamido sebacic acid diamide (2) was prepared by the mixture of sebacic acid dihydrazide (1) (0.01mole) and aryl/alkyl isothiocyanate (0.02 mole) and chloroform (15ml) was refluxed for 2.00 hrs progress of the reaction was monitored by TLC.After the completion of reaction the reaction mixture was cooled and water was added.The crude product was purified by crystallization from ethanol to get title compound. M.P202°C ,Yield 85% (Found N:15.50,S:12.00 )(Requires:N,15.90,S,12,12).

#### General Procedure for 1, 8 bis-(N-aryl/Alkylamino 1, 3, 4 Oxadiazol-5-yl) Octane (3):

A suspension of bis-N-aryl/alkyl sebacic acid diamide (2) was made in alkaline ethanol. To this the dropwise addition of ethanolic molecular iodine was made with constant stirring till the violet colour iodine persisted.After the completion of reaction.The reaction mixture was left overnight at room temperature the solid was obtained.Washed with water and crystallized from ethanol(3).

**TableI:** Physico-chemical data of 1, 8, bis (N-aryl/alkylamino1, 3, 4oxadiazol-5-yl) Octane (3a-g)

Compound	Molecular formula	Percentage yield (%)	M.P(°C)	Elemental analysis Found(Requires)		
				C	H	N
3a	C <sub>26</sub> H <sub>32</sub> N <sub>6</sub> O <sub>2</sub>	89	187	67.58 (67.82)	6.45 (6.95)	18.16 (18.26)
3b	C <sub>26</sub> H <sub>32</sub> N <sub>6</sub> O <sub>2</sub>	82	195	67.70 (67.82)	6.60 (6.95)	18.34 (18.26)
3c	C <sub>26</sub> H <sub>32</sub> N <sub>6</sub> O <sub>2</sub>	78	182	68.00 (67.82)	6.70 (6.95)	18.98 (18.26)
3d	C <sub>24</sub> H <sub>28</sub> N <sub>6</sub> O <sub>2</sub>	85	185	66.05	7.00	19.92



				(66.60)	(6.48)	(19.44)
<b>3e</b>	C <sub>24</sub> H <sub>26</sub> N <sub>6</sub> O <sub>2</sub> CL <sub>2</sub>	81	198	57.02 (57.48)	5.03 (5.18)	16.73 (16.76)
<b>3f</b>	C <sub>24</sub> H <sub>26</sub> N <sub>6</sub> O <sub>2</sub> CL <sub>2</sub>	87	195	56.99 (57.48)	5.08 (5.18)	16.42 (16.76)
<b>3g</b>	C <sub>20</sub> H <sub>20</sub> N <sub>6</sub> O <sub>2</sub>	72	188	61.03 (61.22)	9.14 (9.18)	21.04 (21.42)

**Table II:** Spectral data of 1,8 bis (N-aryl/alkylamino 1,3,4 oxadiazol-5-yl) Octane(3a-g)

Compound	IR Spectra (KBr cm <sup>-1</sup> )	<sup>1</sup> H NMR (DMSO-d <sub>6</sub> , δ)
<b>3a</b>	3221(N-H Stretching), 2926(CH-Stretching), 1600(C=N Stretching), 1488(Ar-C=C Stretching), 1300(C-N Stret.), 1181(C-O Stretc.), 1221(N-N Stret.)	8.0(S,2H,NH-Proton),6.5-7.6(m,8H,Ar-H Proton),2.3(S,6H, Ar-CH <sub>3</sub> -Proton),1.2-3.25(m,6H, (CH <sub>2</sub> ) <sub>8</sub> Proton),
<b>3b</b>	1223(N-N Stretching),1185(C-O Stretching),1299(C-N Stretching), 1488(Ar C=C Stretching), 1600(C=N Stretching),2926(Aliphatic-CH-Stretching),3221(NH-Stretching),	1.23.26(m,16H(CH <sub>2</sub> ) <sub>8</sub> Proton),2.4(S,6H, Ar CH <sub>3</sub> -Proton),6.4-7.6(m,8H,Ar-H-Proton),8.00(S,2H,NH Proton),
<b>3c</b>	1320(C-N Stretching),1180 (C-O Stretching), 1221(N-N Stretching),1487 (ArC=C Stretching), 1600 (C=N Stretching), 3221(NH-Stretching),2926(Aliphatic CH-Stretching)	6.5-7.4(m,8H,Ar-H Proton).2.5(S,6H,Ar-CH <sub>3</sub> Proton),1.3-3.26(m,16H(CH <sub>2</sub> ) <sub>8</sub> )8.01(S,2H,NH Proton),
<b>3d</b>	2932(Aliphatic C-H Stretching), 1620(C=N Stretching), 3221(NH Stretching), 1488(Ar C=C Stretching), 1310(C-N Stret.), 1181(C-O Stret.), 1221(N-N Stret.)	2.4(S,6H,Ar-CH <sub>3</sub> Proton ),6.5-7.7(M,8H,Ar-H Proton),8.01(S,2H,NH-Proton),1.2-3.25(m,16H,(CH <sub>2</sub> ) <sub>8</sub> Proton)
<b>3e</b>	1181(C-O Stret), 1600(C=N Stret), 3221(NH Stret.), 2922(Aliphatic CH Stret.), 1218(N-N Stret), 1488(Ar.C=C), 1320(C-N Stret.),	1.2-3.25(m,16H,(CH <sub>2</sub> ) <sub>8</sub> ),8.01(s,2H,NH Proton),6.4-7.4(m,8H,Ar-H Proton),2.3 (S,6H,Ar-CH <sub>3</sub> Proton )
<b>3f</b>	1620(C=N Stret.), 2930(Aliphatic CH-Stret.)1488(Ar.C=C Stret.), 1300(C-N Stret.), 1181(C-O Stret.), 1221(N-N Stret.), 3221(NH Stret.)	8.01(S,2H,NH-Proton),6.5-7.6(m,8H,AR-H Proton),2.3(s,6H,Ar-CH <sub>3</sub> Proton),1.2-3.25(m,16H,(CH <sub>2</sub> ) <sub>8</sub> )
<b>3g</b>	2926(Aliphatic-CH Stret.), 3223(NH Stret.), 1601(C=N Stret.)1300(C-N Stret.), 1480(Ar-C=C Stret.), 1181(C-O Stret.), 1221(N-N Stret.),	2.4(S,6H,Ar-CH <sub>3</sub> )1.5-3.25(m,16H,(CH <sub>2</sub> ) <sub>8</sub> )8.02(S,2H,NH-),6.5-7.6(m,8H,Ar-H)

**General procedure for the synthesis of 1, 8 bis (2 -aryl/alkylamino 3, 3 diacetyl-1, 3, 4 Oxadiazol-5-yl) octane.:(4)**

A Mixture of 1, 8 bis-(2-aryl/alkylimino -1, 3, 4 oxadiazol-5-yl) octane. (3) (0.01mole) and acetic anhydride (0.02 mole) and glacial acetic acid was placed in round bottom flask(10ml) glacial acetic acid was added slowly to it while stirring magnetically.After 2-hrs of stirring the solution was poured on crushed ice.The resulting solid was separated ,dried and recrystallized from aqueous ethanol similarly compound (4a-g) were prepared.

**Table I:** Physico-chemical data of 1, 8, bis (N-arylimino3, 3 diacetyl-1, 3, 4 oxadiazol-5-yl) Octane (4a-g)

Compound	Molecular formula	Percentage yield (%)	M.P(°C)	Elemental analysis Found (Requires)		
				C	H	N
<b>4a</b>	C <sub>30</sub> H <sub>36</sub> N <sub>6</sub> O <sub>4</sub>	72	184	66.32 (66.17)	6.62 (6.61)	15.63 (15.44)
<b>4b</b>	C <sub>30</sub> H <sub>36</sub> N <sub>6</sub> O <sub>4</sub>	79	191	66.07 (66.17)	6.70 (6.61)	15.72 (15.44)
<b>4c</b>	C <sub>30</sub> H <sub>36</sub> N <sub>6</sub> O <sub>4</sub>	84	180	66.12	6.80	15.06

				(66.17)	(6.61)	(15.44)
<b>4d</b>	C <sub>28</sub> H <sub>32</sub> N <sub>6</sub> O <sub>4</sub>	78	170	64.92 (65.11)	6.80 (6.20)	16.30 (16.27)
<b>4e</b>	C <sub>28</sub> H <sub>30</sub> N <sub>6</sub> O <sub>4</sub> CL <sub>2</sub>	70	198	57.03 (57.43)	5.05 (5.12)	14.36 (14.36)
<b>4f</b>	C <sub>28</sub> H <sub>30</sub> N <sub>6</sub> O <sub>4</sub> CL <sub>2</sub>	87	190	57.12 (57.43)	5.16 (5.12)	14.12 (14.37)
<b>4g</b>	C <sub>24</sub> H <sub>40</sub> N <sub>6</sub> O <sub>4</sub>	76	200	60.10 (60.50)	8.72 (8.40)	17.07 (17.64)

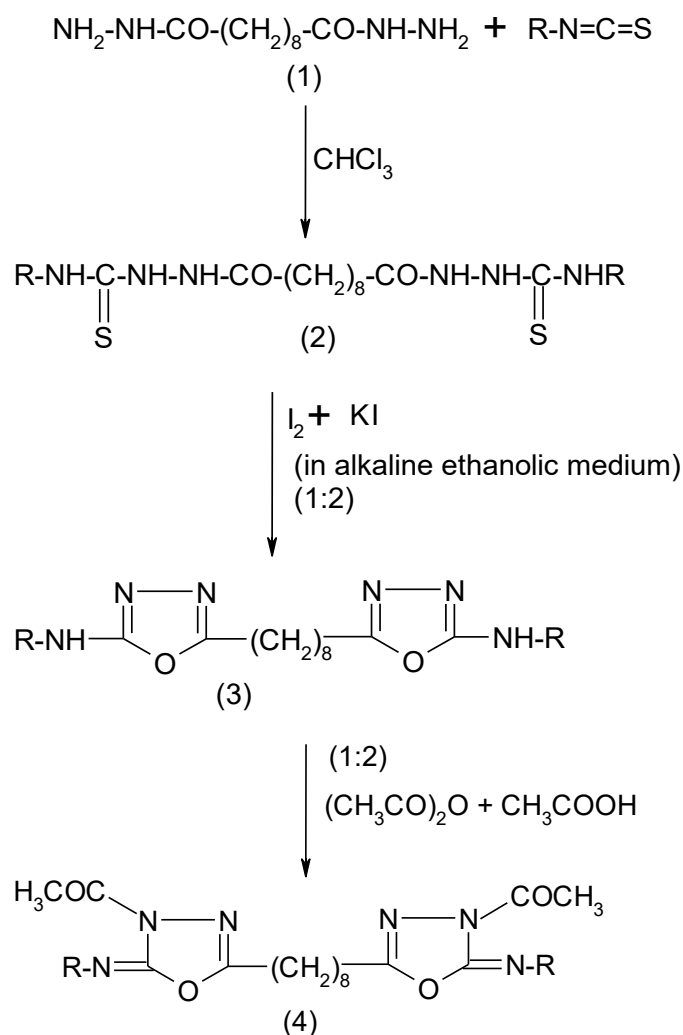
**Table II:** Spectral data of 1, 8 bis (N-arylimino 3, 3 diacetyl-1, 3, 4 oxadiazol-5-yl) Octane (4a-g)

Compound	IR Spectra (KBr cm <sup>-1</sup> )	<sup>1</sup> H NMR (DMSO-d <sub>6</sub> , δ)
<b>4a</b>	2926(Aliphatic CH-Stretching), 1600(C=N Stretching) 1488(Ar-C=C Stretching), 1300(C-N Stret.), 1650(C=O Stretc.), 1221(N-N Stret.)	1.23-3.41(m,8H,Ar-H-Proton),7.1-7.2(m,8H,Ar-H Proton),2.66(S,6H,Ar-CH <sub>3</sub> -Proton),2.17(S,6H,(CO-CH <sub>3</sub> )Proton
<b>4b</b>	1220(N-N Stretching),1640(C=OStretching),1300(C-NStretching),1488(Ar C=CStretching),1600(C=N Stretching),2927(Aliphatic-CH-Stretching)	1.23-3.41(m,16H(CH <sub>2</sub> ) <sub>8</sub> Proton),2.70(S,6H,Ar CH <sub>3</sub> -Proton),7.2-7.4(m,8H,Ar-H-Proton),2.66(S,6H),2.17(S,CO-CH <sub>3</sub> Gr.)
<b>4c</b>	1320(C-NStretching),1660(C=O Stretching),1221(N-N Stretching),1488(ArC=C Stretching),1600(C=N Stretching),2930(Aliphatic CH-Stretching)	6.5-7.4(m,8H,Ar-H Proton).2.70(S,6H,Ar-CH <sub>3</sub> Proton),1.23-3.41(m,16H(CH <sub>2</sub> ) <sub>8</sub> 2.19(S,6H,CO-CH <sub>3</sub> Proton),
<b>4d</b>	2926(Aliphatic C-H Stretching), 1600(C=N Stretching), 1488(Ar C=C Stretching), 1312(C-N Stret.), 1652(C=O Stret.), 1222(N-N Stret.)	2.66(S,6H,Ar-CH <sub>3</sub> Proton ),7.1-7.2(m,8H,Ar-H Proton),2.17(S,6H,CO-CH <sub>3</sub> Proton),1.24-3.41(m,16H,(CH <sub>2</sub> ) <sub>8</sub> Proton)
<b>4e</b>	1650(C=O Stret), 1600(C=N Stret), 2930(Aliphatic CH Stret.), 1224(N-N Stret), 1488(Ar.C=C), 1318(C-NStret.),	1.22-3.42(m,16H,(CH <sub>2</sub> ) <sub>8</sub> ),7.1-7.2(m,8H,Ar-H Proton),2.16(S,6H,CO-CH <sub>3</sub> Proton )
<b>4f</b>	1616(C=NStret.), 2932(Aliphatic CH-Stret.)1490(Ar.C=C Stret.), 1321(C-N Stret.), 1645(C=O Stret.), 1221(N-N Stret.)	7.00-7.2(m,8H,Ar-H Proton),2.19(s,6H,CO-CH <sub>3</sub> Proton),1.23-3.40(m,16H,(CH <sub>2</sub> ) <sub>8</sub> )
<b>4g</b>	2926(Aliphatic-CH Stret.), 1601(C=N Stret.)1300(C-N Stret.), 1480(Ar-C=C Stret.), 1621(C=O Stret.), 1221(N-N Stret.),	2.62(S,6H,Ar-CH <sub>3</sub> )1.21-3.38(m,16H,(CH <sub>2</sub> ) <sub>8</sub> ),7.1-7.4(m,8H,Ar-H),2.20(S,6H,CO-CH <sub>3</sub> )

## RESULT AND DISCUSSION

The sequence of the reaction employed for the synthesis of title compound is outlined in scheme 1. The physicochemical data and spectral data of the different synthesized compound are given. The mixture of sebacic acid dihydrazide and phenyl isothiocyanate converted into bis-N-aryl/alkyl thiocarbamido sebacic acid diamide. The purity of compound was confirmed by melting point, TLC and structure was confirmed by chemical test, IR and <sup>1</sup>H NMR spectral data. IR Spectra showed the characteristic peak -CH Stretching at 3080 cm<sup>-1</sup>, C-O at 1180cm<sup>-1</sup>, NH-Stretching at 3221cm<sup>-1</sup>, C=C at 1480cm<sup>-1</sup>. This bis-N-aryl/alkyl thiocarbamido sebacic acid diamide was reacted with ethanolic molecular iodine gave 1,3,4 oxadiazol-5-yl -octane(3). The purity of this compound was confirmed by melting point, TLC, and structure was confirmed by IR, <sup>1</sup>H NMR and mass spectral data. IR spectra showed the characteristic peak NH- Stretching at 1221cm<sup>-1</sup>, Aliphatic CH-stretching at 2926, C=N stretching at 1600cm<sup>-1</sup>, Ar C=C stretching at 1488cm<sup>-1</sup>, C-N Stretching at 1300cm<sup>-1</sup>, C-O stretching at 1181cm<sup>-1</sup>, N-N stretching at 1221cm<sup>-1</sup>. This 1,3,4 oxadiazol treated with acetic anhydride and glacial acetic acid gave 3,3 diacetyl 1,3,4 oxadiazol-5-yl -octane. The purity of the compound was confirmed by melting point, TLC, and structure was confirmed by IR, <sup>1</sup>H NMR & mass spectral data. IR spectra showed the characteristic peak of aliphatic CH-stretching at 2926cm<sup>-1</sup>, C=N stretching at 1600, C=C stretching at 1488cm<sup>-1</sup>, N-N stretching at 1221cm<sup>-1</sup>, C-N stretching at 1300cm<sup>-1</sup>, C-O stretching 1650cm<sup>-1</sup>. The other compound (4a-g) were prepared by extending the acetylation reaction to other compound (3a-g) and gave the title compound(4a-g).

SCHEME



Where,

R= o-tolyl, m-tolyl, p-tolyl, phenyl, p-chlorophenyl, m-chlorophenyl and t-butyl

CONCLUSION

Among all the synthesized derivatives of 1, 3, 4 oxadiazol were derived from different chemical reaction. All the synthesized compound were characterized by physicochemical and spectral analysis. The melting point and thin layer chromatography were performed check purity of the synthesized compound. Spectral studies i.e IR, NMR & mass were performed for structure confirmation. All the compound were synthesized with good yield.

REFERENCES

1. Yu Yan-Xin, Liu Fang Xin- Min,, Liu Yu-Thing, Liu Cong, Chinese journal of Organic Chemistry, 20(1), (2000)
2. A.A Ziyaev, G G. Galastyan, Chemistry of Heterocyclic Compound, 9(262)(1997), 1152-1296
3. J.R. Kavali, O, Kotresh, B. U. Baclami, Journal of chemical Research 5(4) (2003), 275-278
4. A. H. Abadi, A. A. Eissa, G.S. Hassan, Chem. Pharma. Bull. (Tokyo), 51(7)(2003), 838-44
5. Wojeiech Czardybon, Arkadiusz Klys, John Warkentin, Nick Henry Werstiuk, Canadian journal of chemistry, 81(2003), 1438-1442
6. E. Borkhite, T. Mohammed, A. Rahman, J. Chem. Technol. Biotechnol., 55(1992), 157-161
7. T. Dabhi, V. Shah, A. Parikh, Indian J. Pharma. Studies, 54(1992), 98-100
8. M. M Hamad, S.A Said, Y. M EL-Ekyabi, Montash Chem., 127(1996), 549-555

9. B. S. Holla, k.N Poojary, B.Kalluraya, P. V.Gowada, Indian J. Heterocyclic Chem., 5(1996) ,273-276
10. K. A Omar, N.M. Mantouz, Rahman,Eur. J. Med. Chem., 31(1996),819-825
11. M. Santgati, M.Modica, A, Santgati, F. Russo, A .Carusa, Pharmazie,49(1994),880-884
12. A. A EL-Eman, O. A. AL-Deeb, M. AL-Omar, J Lehman Bioorg. Med. Chem.,12(9)(2004),5107-12
13. H.Takayama, S. Shrikawa, M. Kitajima, N.Aimi,Bioorg.Med,Chem. Letter,6(1996),1993-1996
14. Anand Kumar Dubey and Naresh K. Sangwan, Indian J. Chem., 33B(1994), 1043 A. Mashooq Bhat, B.A. Khan, N. Siddiqui, Indian J. Heterocyclic Chem., 14(2005),271
15. Nizamuddin, Madhulika Misgra and Manoj Kumar Srivastava, Indian J. Chem.,40B(2001)49
16. S.A. Charanjit, T. C Laner and A. N. Sarin, Indian J. Pharma.Sci., 4B(1986),192
17. M. S. Y/Khan and A. A. Siddiqui, Indian J. Chem.,39B(2000), 164
18. A.A Siddiqui and S.W Wani,Indian J.Chem.,43B(2004)1574
19. A. A Siddiqui, S. W. Wani and A. Khushur,Indian J. Chem.,13(2004)257
20. B. S. Furnis, A. J. Hannaford, P. W. G. Smith and A.R. Tatchell,"Vogel's Text book of practical organic chemistry",5<sup>th</sup> Edn.,Longman, UK()1989
21. G. M. Dyson and T. Harington,J Chem,Soc.,191(1940)
22. N. B. Colthup,L.H Daly and S. E.Wiberly,"Introduction to Infrared and raman spectroscopy"Academic press ,New York(1964)
23. R. M. Silverstein,G.C.Bassler and T.C.Morrill,"Spectrometric identification of organic compounds" 4<sup>th</sup> Edn., John Wiley and Sons,New York(1981)
24. Singhai A.,Gupta M. K. Synthesis and characterization of 1,3,4 Oxadiazol derivatives,2018;8(6-A):25-27

## Secure Digital India: The Role of Artificial Intelligence in Cybersecurity

Prashant Chauhan and Gagandeep Kaur

School of Law, University of Petroleum and Energy Studies, Dehradun, Uttarakhand, India

### ABSTRACT

In the aftermath of the COVID-19 outbreak, the government of India has made digitalization a top priority. Moving one step forward in terms of technology the purpose of this paper is to examine the role artificial intelligence can play in promoting the Digital India program of the government of India. The method of implementation is doctrinal, by which the current trend related to the application of artificial intelligence in the field of cyberspace is examined, along with that the approach is to identify the areas that are relevant and appropriate in the field cyberspace where Artificial Intelligence can be implemented. The research paper concludes that employing artificial intelligence in cyberspace for cybersecurity will be a revolutionary step in helping to create a safe, digital India.

Keywords: Artificial intelligence; Digitalization; Data breach; Cybersecurity; Digital India.

### 1. INTRODUCTION

The process of transforming information available in analog form to electronic form is known as digitalization. With the use of information and digital data, digital innovation promotes work efficiency by boosting business performance. Digital India aspires to improve efficiency and productivity by utilizing digital means in the economy<sup>1</sup>. During the mid-1990s, e-governance initiatives in India became more extensive, concentrating on services that focus on citizens. Even though these e-government projects were citizen-centric, their limited features meant they could not have the desired impact<sup>2</sup>. Using digital is seen as a tool for transformation that extends beyond our normal way of life to the way we lead, trade, interact and run our business. In all sectors, public and private, be it communication, media, health care, marketing, and manufacturing, one can increasingly witness the use of digital technology. This is mainly driven by innovation and the rise of e-commerce, e-commerce, and the increasing use of the Internet<sup>3</sup>.

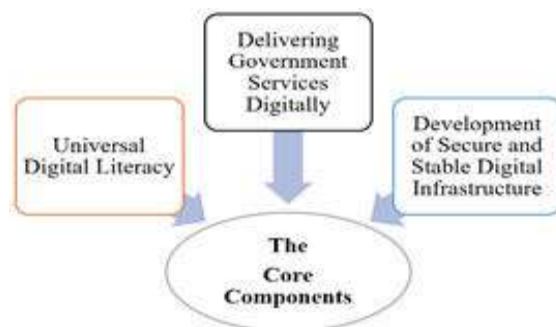
Increasing internet access and improving online infrastructure, as well as empowering digitally the population of this country in the sphere of technology, the objective of Digital India is to make available government services to all Indian citizens over the internet. A new campaign was launched in India on 1st July 2015 launching with the motto - "Power to Empower". Apart from being a component of several other key Indian projects, such as Make in India, Standup India, Sagarma, industrial corridors, Startup India, BharatNet, UDAN-RCS, and Bharatmala, it also provides a crucial link for various other schemes. This initiative aims to increase digital literacy in rural areas by linking them to high-speed internet<sup>4</sup>. India's digital transformation has three core components as represented by Fig.1 as following: -

<sup>1</sup> S. Kumar and Shekhar, "Digitalization: A Strategic Approach for Development of Tourism Industry in India," vol. 24, no. 1, pp. 93–108, Apr. (2020), doi: 10.1177/0971890720914111.

<sup>2</sup> "Introduction | Digital India Programme | Ministry of Electronics & Information Technology (MeitY) Government of India." <https://www.digitalindia.gov.in/content/introduction> (accessed Jan. 08, 2022).

<sup>3</sup> S. Kaur and P. Madan, "Digitalization in India: Cashless, Paperless & Faceless," *Asian J. Multidimens. Res.*, vol. 6, no. 6, pp. 5–14, (2017), Accessed: Jan. 08, 2022. [Online]. Available: <https://www.indianjournals.com/ijor.aspx?target=ijor:ajmr&volume=6&issue=6&article=001>.

<sup>4</sup> "Digital India 'Power to Empower,'" 2021, Accessed: Jan. 06, (2022). [Online]. Available: <https://indiancc.mygov.in/wp-content/uploads/2021/06/mygov-999999999157405609.pdf>.



**Fig. 1:** Diagram representing the core components of the Digital India initiative

According to Sectors, verticals, individuals, cultures, languages, and geographic regions are all represented in India's digital classifieds industry. As a result of such diversity, there are diverse market opportunities<sup>1</sup>. India is one of the largest online markets in the world despite its untapped potential<sup>2</sup>. Despite a standard technological blueprint, tinkering and local adaptations will be necessary due to domestic factor endowments and institutional realities<sup>3</sup>. Digitalization is allowing cities to become smart cities, and the government is moving towards e-government<sup>4</sup>.

The digitalization of the economy creates new jobs, facilitates better working conditions, and brings innovation. This increases transparency in the system and less tax evasion, parallel economy, etc. will occur due to the greater transparency of the flow of funds<sup>5</sup>. Technology, such as mobile applications and the cloud, is considered one of the main catalysts for rapid economic growth and citizen empowerment. These technologies are used by many across all sectors of society, from government agencies to retail outlets. By sharing information on matters of concern or issue, they help in staying connected.

The internet has now become an indispensable component of daily life. It has become a primary medium of communication and commerce. Businesses have also been turning to the web for their operations. As a result, e-commerce has grown significantly. A great deal of government work is also been conducted online, and the world of e-finance has grown greatly over the last couple of years. Internet usage has increased the apprehension of peril associated with it. Advances in internet technology have led to both positive and negative implications. The negative impact of the emergence of cybercrime, especially in the commercial world business transactions<sup>6</sup>.

The virtual world needs special attention concerning crime, law, and criminal policy, due to its particular characteristics i.e., it is global, fast, transcendent, digital, and facilitation of automated information processing, the Internet offers special opportunities for cybercrime as a major tool<sup>7</sup>. The purpose of cyber law is to protect

<sup>1</sup> D. Mukhopadhyay and A. K. Mandal, "Smartphone, Internet, and Digitalization in India-An Exploratory Analysis," PRAGATI J. Indian Econ., vol. 6, no. 2, p. 22, Dec. 2019, doi: 10.17492/PRAGATI.V6I2.187355.

<sup>2</sup> J. W. Fernandes, "DIGITALIZATION IN INDIA: TRENDS AND CHALLENGES," Int. J. Recent Trends Bus. Tour., vol. 2, no. 3, pp. 45–47, Jul. 2018, Accessed: Jan. 08, (2022). [Online]. Available: <https://ejournal.lucp.net/index.php/ijrtbt/article/view/197>.

<sup>3</sup> R. Hausmann, J. Hwang, D. Rodrik, and J. F. Kennedy, "What You Export Matters What You Export Matters What You Export Matters," (2005).

<sup>4</sup> A. D. Gaur and J. Padiya, "A Study Impact of 'Digital India 'in 'Make in India' Program in IT & BPM Sector," no. April, (2016), [Online]. Available: <http://www.aims-international.org/aims14/publication.asp>.

<sup>5</sup> D. Sihmar and R. K. Meena, "Digitalization in India: An Innovative Concept," Int. J. Eng. Dev. Res., vol. 7, no. 1, pp. 452–456, (2019).

<sup>6</sup> N. Setiawan et al., "IMPACT OF CYBERCRIME IN E-BUSINESS AND TRUST," Artic. Int. J. Civ. Eng. Technol., vol. 6, no. 7, pp. 652–656, (2018), Accessed: Jan. 08, 2022. [Online]. Available: <http://www.iaeme.com/IJCIET/index.asp652http://www.iaeme.com/ijciyet/issues.asp?JType=IJCIET&VType=9&IType=7http://www.iaeme.com/ijciyet/issues.asp?JType=IJCIET&VType=9&IType=7>.

<sup>7</sup> B.-J. Koops, "The Internet and its Opportunities for Cybercrime," SSRN Electron. J., no. 09, (2012), doi: 10.2139/ssrn.1738223.

cyberspace from cybercrime by preventing it in the first place. Lawmakers and law enforcement encounter difficulty in preventing this crime. To prevent illegal activities from occurring online, government officials have formulated and established certain laws. With the new technologies growing at a rapid pace the challenge of securing cyberspace has become more demanding. One such new-age technology is Artificial Intelligence. The National Institution for Transforming India (NITI Aayog) in June 2018 published a national-level strategy on artificial intelligence as #AIForAll.

NITI Aayog concentrated on a three-dimensional approach including the exploration of the concept of artificial intelligence in its application in various fields, creating an artificial intelligence-based ecosystem, and collaborating with the stakeholders and the experts in the field of artificial intelligence. NITI Aayog shall also tend to identify the sectors having greater potential to assimilate artificial intelligence. NITI Aayog in February 2021 came up with a report on Responsible AI#AIFORALL. The approach in this document to promote innovative measure in enhancing trust in the utilizations and adoption of artificial intelligence with increased measures of safeguarding public interest. The said document intends to examine the possible risk that might arise due to the use of artificial intelligence, with an approach to search for managing principle for responsible artificial intelligence. Hence the approach is to implement AI into the governance in order to realize the concept of welfare state in a more prominent manner.

## **2. METHOD**

The juridical normative method has been applied in this research paper. The approach shall be to examine the existing textual material available to understand the problem and arrive at probable solutions. Reliance has been placed upon the textual and library material and documents

### **3. Digital India: The Aim and Vision**

To boost efficiency and production, Digital India strives to promote the use of electronic methods in the economy. Under India's Digital initiative, the Indian Government aims to make India not only a society that is accredited as digital but also an economy based on digital knowledge. There are three focuses areas identified by the Indian government in its efforts towards a making nation that is empowered digitally. The three focus areas as briefly discussed as follow: -.

#### **3.1. Every Citizen Should have Access to Digital Infrastructure**

The first area of focus lays stress on creating a robust digital infrastructure that shall be within the accessible limits of the Indian national.

- a) Powerful computer network: The accessibility and availability internet have a huge impact on citizens' access to services. By improving internet access, the government will be able to reach as many people and citizens will be able to access it whenever they want, regardless of geographic location.
- b) Cloud space: Every citizen will also have access to the cloud private space where they can store information and documents relevant to their specific services securely. A digital repository will be housed in the shared private space.
- c) Identification through digital mode: The 12-digit Aadhaar number is issued by the Unique Identification Authority of India (UIDAI) as part of the national level project of the Indian government to ensure that Indian citizens have a distinctive, life-long, electronic, and verified digital identity.
- d) Financial Services: Cellphones and bank account information allows digital and financial involvement. As a national objective, the Pradhan Mantri Jan-Dhan Yojana includes an integrated plan to guarantee that all households in the country are economically included. everyone shall have access to all types of banking services at their fingertips. Furthermore, all government payments will be deposited directly into the bank accounts of recipients.
- e) Dedicated center for service: Common Service Centers can match the social and economic aims of government, industrial, and social sector organizations for the benefit of the rural population is perhaps the most remote corner of the country by integrating IT and non-IT services.
- f) Maintaining safe and secure cyberspace: Keeping cyberspace safe and secure is critical for fostering trust in citizens and enabling them to use facilities without fear.

#### **3.2. Every Citizen Should have Access to Digital Infrastructure**

The second area of focus emphasizes making government initiatives and services easily accessible to citizens within their financial means.

- a) **Integrated Service Providing:** The government agencies providing the service typically require documentation, authorizations, and approvals to obtain the service. Nowadays, the objective is to give companies and individuals a single portal through which to access of that kind services, avoiding the need to navigate between different departments or government units.
- b) **Real-Time Access:** The emphasis in today's e-Government system is on providing actual information, facilities, and grievance handling throughout all types of access devices, including personal computers, laptop computers, tablets, and cellular phones.
- c) **Cloud-Based Entitlements:** Citizens' entitlements will be managed via the cloud platform, registered, maintained, and distributed under a variety of governmental initiatives. Citizens will be able to receive their entitlements from anywhere and anytime. It is not necessary for a citizen who relocates to lose his or her benefits, the individual will not have to go through a time-consuming registration process and provide documentation again to receive benefits.
- d) **Making it Easier to do Business:** Among other things, related to business activities and all experiences that determine how easy or difficult it is to do business in a country. Government services for businesses will be digitally modernized to enhance the country's Ease of Doing Business.
- e) **Redefining Financial Transactions:** Without the need of middlemen who could otherwise abuse the power of the system, virtual currencies and money transfers have the advantage of being targeted and distributed directly to the intended receiver. Similarly, online fee payment systems for many government services provide citizens with a clear, user-friendly, and speedy payment option. All financial transactions over a certain amount must be conducted electronically and without the use of cash.
- f) **Decision-Making Support Systems:** This GIS platform is being utilized to serve a range of mission mode initiatives and e-government projects as a service. The National Geographic Information System (NGIS) can also be utilized to track project progress, disaster risk management, and the unique needs of public safety organizations.

### 3.3. Using Digital Tools to Empower Citizens

The third focal area emphasizes citizen empowerment through digital methods through raising digital awareness.

- a) **Digitally proficient citizen:** To fully realize the potential of the Digital India program, digital literacy is required on a personal level. It empowers citizens by allowing them to fully utilize digital technologies. It enables people to pursue better employment options and achieve financial stability.
- b) **Availability of digital resources:** Users' devices, which may be smartphones, tablet devices, Desktops, or other gadgets, are only as excellent as how they're displayed on digital resources. As all of these devices can access webpages with electronic content, they may have different support requirements and may or may not be able to display and structure content in different ways.
- c) **Indian language interactive resources:** India has a great diversity of languages throughout different parts of the country. In India there 22 language officials were recognized. Only a small percentage of the country's population speaks English. The general public frequently lacks access to or comprehension of digital resources, which are mostly given in English.
- d) **Collaborative digital platforms for participatory governance:** Consumers have traditionally relied on digital platforms to communicate information as well as provide services. These establishments enable the state to communicate with civilians, but it was primarily one-way communication. Digital platforms have progressed to the point that they can now support government organizations in having effective two-way interaction and interaction with individuals, due to technological breakthroughs.
- e) **Absence of physical document submittal:** Citizens should not be asked to provide physical copies of government papers or certifications which are already accessible from a governmental department or organization. Any digital information must also be safe in terms of portability



#### 4. Cybersecurity: Securing the Virtual Space

As most business activities are becoming automated and an increasing number of computers are used to store confidential information, the need for making computer systems more secure becomes increasingly evident<sup>1</sup>. The rapid growth of internet communication has led to a dramatic increase in online attacks often having disastrous and painful consequences. A malware program is an ultimate weapon in the pursuit of cyberattacks, by exploiting existing vulnerabilities or using different aspects of emerging technologies<sup>2</sup>. The National Cyber Security Centre and other agencies have identified 30 vulnerabilities that cyber actors will routinely exploit in 2020, as well as those that will be exploited in 2021<sup>3</sup>. Dependence upon ICT by smart cities has also facilitated cyber intrusions<sup>4</sup>.

COVID-19 pandemic has contributed to the rise in the case of a cybersecurity breach. Swissinfo.ch in June 2020 stated that the NCSC (National Cyber Security Center) reported 350 cases of cyberattacks (phishing, fraudulent websites, direct attacks on companies, etc.) in April, compared to the normal 100-150 cases that while working from home, 47% of people had fallen for a phishing scam. Since January 2020, more than GBP 11 million has been lost as a result of COVID-19 scams, according to the City of London Police<sup>5</sup>. Cybersecurity can be termed as a protective shield to ensure the confidentiality, integrity, and availability of information through secure networks, devices, and data.

Computers and the internet appear to be relied on more and more every day these days as the mode of communication. A malware infection can wipe out your entire system, a hacker can break into your device and change your files, a hacker can use your computer to attack others, or your credit card information can be stolen and used for unauthorized purchases. Despite the best precautions one can take, there is no guarantee that one of these things will not happen to you, but you can take steps to minimize the chances. There are several types of threats to Cyber security, some of the common threats to cybersecurity are as follows: -

##### 4.1. Hackers, Attackers, and Intruders

A cyber-attack can be either offensive or defensive. Cyber activity can result in injury to a person or cause death, as well as damage or destruction to the property<sup>6</sup>. A malevolent attacker could use infected workstations to search for or disrupt any information on them, and/or use them to launch large-scale attacks on the Internet infrastructure<sup>7</sup>. However, their activities are typically in violation of the actual intended use of the network systems they are exploiting, even if their intentions are sometimes harmless and motivated because of curiosity.

##### 4.2. Codes of Malicious Nature

A malicious program (also known as malware) is a file or program that can damage a computer's operation or compromise its data. Malicious code can steal personal information and privacy without the user's knowledge<sup>8</sup>. Malicious code can be classified according to worms, viruses, and Trojan horses. Malicious code typically has these characteristics: -

<sup>1</sup> R. A. Kemmerer, "Cybersecurity," Proc. - Int. Conf. Softw. Eng., pp. 705–715, (2003), doi: 10.1109/ICSE.2003.1201257.

<sup>2</sup> J. Jang-Jaccard and S. Nepal, "A survey of emerging threats in cybersecurity," J. Comput. Syst. Sci., vol. 80, no. 5, pp. 973–993, Aug. 2014, doi: 10.1016/J.JCSS.2014.02.005.

<sup>3</sup> "UK and allies publish advice to fix global cyber... - NCSC.GOV.UK." <https://www.ncsc.gov.uk/news/global-cyber-vulnerabilities-advice> (accessed Jan. 09, 2022).

<sup>4</sup> A. Alibasic, R. Al Junaibi, Z. Aung, W. L. Woon, and M. A. Omar, "Cybersecurity for Smart Cities: A Brief Review," Lect. Notes Comput. Sci. (including Subser. Lect. Notes Artif. Intell. Lect. Notes Bioinformatics), vol. 10097 LNAI, pp. 22–30, 2016, doi: 10.1007/978-3-319-50947-1\_3.

<sup>5</sup> "Impact of COVID-19 on Cybersecurity." <https://www2.deloitte.com/ch/en/pages/risk/articles/impact-covid-cybersecurity.html> (accessed Jan. 09, 2022).

<sup>6</sup> J. A. Bullock, G. D. Haddow, and D. P. Coppola, "Cybersecurity and critical infrastructure protection," *Introd. to Homel. Secur.*, pp. 425–497, Jan. (2021), doi: 10.1016/B978-0-12-817137-0.00008-0.

<sup>7</sup> N. Weaver, V. Paxson, S. Staniford, and R. Cunningham, "Large Scale Malicious Code: A Research Agenda \* †."

<sup>8</sup> B. Y. Zhang, X. A. Yan, and D. Q. Tang, "Survey on Malicious Code Intelligent Detection Techniques," *J. Phys. Conf. Ser.*, vol. 1087, no. 6, (2018), doi: 10.1088/1742-6596/1087/6/062026.

- a) The computer system may need to be physically infected before it becomes infected. An email attachment or a webpage could be one example of this action.
- b) Typical software vulnerabilities are exploited by malware that propagates without user intervention. When an infected computer is found, the malware will begin searching for other computers to infect. Email, websites, and network-based software can also be used to distribute this malware.
- c) Malware may appear as one thing, but secretly do something different. You may be sending confidential information to an intruder by installing a program that claims to speed up your computer.

### 4.3. SUSCEPTIBILITY

Attackers can exploit vulnerabilities in software, firmware, or hardware to perform unauthorized actions on a system. Programming errors can be responsible for these vulnerabilities. Malware or other malicious activities can be carried out on computers caused by these errors. Phishing, denial-of-service attacks, and malware are all examples of frequent security flaws<sup>1</sup>. The issues discussed above are required to be redressed to create more formidable cyberspace.

### 5. Artificial Intelligence: A New Age Technological Tool

With the passage of time, cybercrime and the safeguarding of data keep on parting along with unmistakable courses. Companies are being tested by how they protect their infrastructure, yet additionally by how they require new stages and insight to do as such, because of the most recent and troublesome advancements, just as the new digital instruments and dangers that arise each day<sup>2</sup>. The increasing use of artificial intelligence by hackers has endangered the vulnerability of the potential secured data. The process to recover data is a time taking process. The use of artificial intelligence is far ahead in comparison to the traditional methods of cybersecurity. Due to the potential benefits of artificial intelligence organizations are required to shift their focus on creating secure cyberspace using artificial intelligence. AI is explained as a field that focuses on designing and making intelligent, autonomous machines and in particular intelligent computer programs. This is similar to studying human intelligence through the use of computers, but AI is not restricted to methods that can be observed by biological means<sup>3</sup>.

Microsoft's fully integrated AI system, called a System of Intelligence, ingests human-level knowledge (for example, via machine learning and computer vision) and automates and accelerates tasks previously performed only by humans<sup>4</sup>. A computer system is considered artificially intelligent if it can learn from its actions and solve complex problems in various situations an ability previously thought to be unique to humans<sup>5</sup>. The application of artificial intelligence, which is regarded as a branch of computer science, is taking care of very intricate issues that can't be addressed utilizing direct estimations or mathematical calculations. The machine infused with AI takes an approach similar to humans in solving problems through these methods<sup>6</sup>. Sensors, operational logic, and actuators are the main components of AI systems. Actuators make the environment change based on raw data collected by sensors. A system's operational logic determines its effectiveness. Using sensor data input and the operational logic, actuators receive output based on a set of objectives. A recommendation, prediction, or decision can affect the state of an environment<sup>7</sup>. The science of robotics and computer science are widely considered related fields. An IT system with artificial intelligence is capable of

<sup>1</sup> M. Humayun, M. Niazi, N. Jhanjhi, M. Alshayeb, and S. Mahmood, "Cyber Security Threats and Vulnerabilities: A Systematic Mapping Study," Arab. J. Sci. Eng., vol. 45, no. 4, pp. 3171–3189, Apr. (2020), doi: 10.1007/S13369-019-04319-2.

<sup>2</sup> G. N. Reddy and G. J. U. Reddy, "A Study of Cyber Security Challenges and Its Emerging Trends on Latest Technologies," no. February, (2014), [Online]. Available: <http://arxiv.org/abs/1402.1842>.

<sup>3</sup> J. Mccarthy, "WHAT IS ARTIFICIAL INTELLIGENCE?" pp. 1–14, (1998).

<sup>4</sup> M. A. Taddy, "The Technological Elements of Artificial Intelligence," Ssrn, (2018), doi: 10.3386/w24301.

<sup>5</sup> D. Jezova, "Artificial intelligence and privacy," Hum. Rights - From Real. to virtual world, no. January, pp. 226–237, (2021), doi: 10.13166/wsge//xuxl1897.

<sup>6</sup> S. Alzou'bi, H. Alshibl, and M. Al-Ma'aitah, "Artificial Intelligence in Law Enforcement, A Review," Int. J. Adv. Inf. Technol., vol. 4, no. 4, pp. 1–9, (2014), doi: 10.5121/ijait.2014.4401.

<sup>7</sup> OECD, Artificial Intelligence in Society. (2019).

correctly interpreting external data, learning from it, and using that experience to accomplish specific tasks. Flexible adaptation to external conditions is part of this ability<sup>1</sup>. As computer systems learn and perform complex tasks that were previously performed by humans, artificial intelligence is spreading its roots to different areas by using the principle of making computers handle complex tasks formerly performed by humans. AI improves accuracy and speeds up work processing<sup>2</sup>. As a general rule, non-human intelligence (AI) is the ability of PCs to perform assignments ordinarily performed by individuals, for example, visual discernment, discourse acknowledgment, navigation, and language interpretation. In the context of data protection tools, this term encompasses a broad range of technical innovations<sup>3</sup>.

There is no iota of doubt that technology of such a kind in form of artificial intelligence can be a great benefit for mankind. Several positive aspects have been projected for its use. But every technology comes with a price same is with artificial intelligence. Technology is created by a human so it can be manipulated as well. Such manipulation may result in showcasing the negative impact of technology. We agree that there are pros and cons to every technology. But our concern is whether international laws a compatible enough to regulate effectively the use of this particular technology. Why international law and not local laws? because the internet knows no boundaries restricting cyberspace to a particular territory is not possible or to say impractical.

## **6. AI and Cybersecurity; Securing the Parameters**

Artificial intelligence can have a positive impact in the field of cyber security because of the following reasons:

### **6.1. Big Data can be Handled by AI**

An organization's network is very active. A typical midsize firm sees a lot of traffic. It implies that the company and the customers have a great deal of data exchange daily. Artificial intelligence provides the most effective means of detecting threats that can be masked as routine activities. It can process enormous amounts of data and traffic due to its automated nature. Additionally, it is capable of detecting and identifying any hazards lurking in the chaos.

### **6.2. The Response Time and Detection Rate are Boosted**

Identifying dangers is the initial move toward securing the organization's network. Coordinating AI and network protection is the best method for recognizing and responding to constant attacks on the company's network. Computerized reasoning (AI) checks the whole framework for potential weaknesses. In contrast to humans, AI will identify dangers early and respond quickly to security tasks.

### **6.3. Enhanced Vulnerability Management**

Susceptibility is perilous to the security of the network domain of an organization. Artificial intelligence Investigations can assist in finding the shortcomings in the security of the company's network by examining and evaluating existing safety mechanisms. Simulated intelligence permits dissecting the frameworks quicker than network safety specialists, fundamentally further developing critical thinking capacities.

### **6.4. Authenticity Defense**

Most sites give a client account through which clients can sign in and access services or make buys. A few sites have contact frames that guests should finish up with their data. Since such a site contains private data and delicate material, one will require extra preventive measures to defend the business interests. AI secures authentication when a user wishes to connect to their account. Artificial intelligence involves an assortment of procedures for ID, including face identifications, CAPTCHA, and finger impression perception, among others. The information from these qualities can be utilized to decide if a sign-in endeavor is real or not. Programmers use accreditation stuffing and savage power to get admittance to business organizations networks

### **6.5. Better Overall Security**

Hazards influencing corporate organizations will subsist all the time. The programmers change their strategies consistently. It is hard to focus on security exercises in an organization along with these constantly changing strategies. Stealing of hypersensitive data, hacking of administration, or ransomware are kinds of activities that

<sup>1</sup> K. Ziemianin, "Civil legal personality of artificial intelligence. Future or utopia?" *Internet Policy Rev.*, vol. 10, no. 2, pp. 1–22, 2021, doi: 10.14763/2021.2.1544.

<sup>2</sup> B. Hotel, "Scope of Artificial Intelligence in Business," no. December, (2008), doi: 10.20944/preprints201806.0474.v1.

<sup>3</sup> F. H. Cate and R. Dockery, "Artificial Intelligence and Data Protection: Observations on a Growing Conflict Fred H. Cate & Rachel Dockery 1," pp. 1–30, (2018).

can take place at the same time. The arrangement lies in the reconciliation of artificial consciousness (AI) into framework organization to identify a wide range of dangers, focus on them, and anticipate them.

## 7. CONCLUSION

With the expanding cyberspace, there is an urgent need to focus on making the virtual world more formidable. The process of digitalization has broadened the database of the organizations, making them vulnerable to possible cyber-attacks. Artificial intelligence can play a very important in securing cyberspace. As discussed earlier that NITI ayog has been making efforts for creating an environment for unraveling the potential of AI, together with the focus on more ethical use of AI. But the field of digitization has not been covered. The proposal of encouraging self-regulation does not seem to be appropriate. As the use of artificial intelligence will affect a large number of people self-regulatory mechanisms may defeat the very purpose of regulating artificial intelligence in consonance with international standards. There has to a statute for regulating having command of sovereign for such kind of technology which has far reaching implications. The persons involved in cybercrime are devising new means to intrude into the cyber networks for their ulterior motives. The rise in cyber-attacks was evident in the pandemic COVID-19. The shifting of financial transactions to digital mode has not only resulted in inconvenience but also saw the rise in online financial fraud. Securing cyberspace is in the interest of both India as a nation and the individual as well.

## 8. SUGGESTIONS

In this paper, the following suggestions are forwarded: -

- a. **Specific Regulations/Legislation-** As every domain has its own implications and limitations, the regulatory measures must be subject oriented. Cyberspace has seen a vast expansion which has resulted in exposure to its formidability. The regulatory measures must be such, as to accommodate the working principles of the cyberspace. The regulations must contain SOPs in relation to AI and computer networks. The stakeholders involved in the service industry related to cyberspace must be compulsory registered, so that unauthorized access can be curbed.
- b. **Centralized Authority-** The regulation/legislation must have specific provision for establishing a central monitoring authority. The primary objective of the authority shall be to overlook the implementation of the regulation/legislation, laying down the directions for effective implementation of regulation/legislation and act as watchdog for the activities of the stake holders.
- c. **Stringent Penalty Provisions-** The regulation/legislation must contain provisions for strict penalties. As the cyberspace is full of information/data, it also carries information/data of sensitive nature. This sensitive information might be related to government, any organization or the individual. Any breach of cybersecurity will make the data vulnerable and endanger the secrecy/privacy of the information holders.

## REFERENCES

1. Alibasic, Armin, Reem Al Junaibi, Zeyar Aung, Wei Lee Woon, and Mohammad Atif Omar. 2016. "Cybersecurity for Smart Cities: A Brief Review." Lecture Notes in Computer Science (Including Subseries Lecture Notes in Artificial Intelligence and Lecture Notes in Bioinformatics) 10097 LNAI: 22–30. [https://doi.org/10.1007/978-3-319-50947-1\\_3](https://doi.org/10.1007/978-3-319-50947-1_3).
2. Alzou'bi, Suhaib, Haitham Alshibl, and Mohammad Al-Ma'aitah. 2014. "Artificial Intelligence in Law Enforcement, A Review." International Journal of Advanced Information Technology 4 (4): 1–9. <https://doi.org/10.5121/ijait.2014.4401>.
3. Bullock, Jane A., George D. Haddow, and Damon P. Coppola. 2021. "Cybersecurity and Critical Infrastructure Protection." Introduction to Homeland Security, January, 425–97. <https://doi.org/10.1016/B978-0-12-817137-0.00008-0>.
4. Cate, Fred H, and Rachel Dockery. 2018. "Artificial Intelligence and Data Protection: Observations on a Growing Conflict Fred H. Cate & Rachel Dockery 1," 1–30.
5. "Dgital India 'Power to Empower.'" 2021. <https://indiancc.mygov.in/wp-content/uploads/2021/06/mygov-999999999157405609.pdf>.
6. Easttom, Chuck. 2012. Computer Security Fundamentals / Chuck Easttom. <http://spydus8.nmit.vic.edu.au:2048/login?url=http://search.ebscohost.com/login.aspx?direct=true&db=cat00793a&AN=nmit.87670&site=eds-live>.
7. Fernandes, Jennifer Wilson. 2018. "DIGITALIZATION IN INDIA: TRENDS AND CHALLENGES."

- International Journal on Recent Trends in Business and Tourism (IJRTBT) 2 (3): 45–47. <https://ejournal.lucp.net/index.php/ijrtbt/article/view/197>.
8. Gaur, Ashutosh D, and Jasmin Padiya. 2016. “A Study Impact of 'Digital India 'in 'Make in India' Program in IT & BPM Sector,” no. April. <http://www.aims-international.org/aims14/publication.asp>.
  9. Hausmann, Ricardo, Jason Hwang, Dani Rodrik, and John F Kennedy. 2005. “What You Export Matters What You Export Matters What You Export Matters.”
  10. Hotel, Best. 2008. “Scope of Artificial Intelligence in Business,” no. December. <https://doi.org/10.20944/preprints201806.0474.v1>.
  11. Humayun, Mamoona, Mahmood Niazi, Nz Jhanjhi, Mohammad Alshayeb, and Sajjad Mahmood. 2020. “Cyber Security Threats and Vulnerabilities: A Systematic Mapping Study.” *Arabian Journal for Science and Engineering* 45 (4): 3171–89. <https://doi.org/10.1007/S13369-019-04319-2>.
  12. “Impact of COVID-19 on Cybersecurity.” n.d. Accessed January 9, 2022. <https://www2.deloitte.com/ch/en/pages/risk/articles/impact-covid-cybersecurity.html>.
  13. “Introduction | Digital India Programme | Ministry of Electronics & Information Technology(MeitY) Government of India.” n.d. Accessed January 8, 2022.
  14. Jang-Jaccard, Julian, and Surya Nepal. 2014. “A Survey of Emerging Threats in Cybersecurity.” *Journal of Computer and System Sciences* 80 (5): 973–93. <https://doi.org/10.1016/J.JCSS.2014.02.005>.
  15. Jezova, Daniela. 2021. “Artificial Intelligence and Privacy.” *Human Rights - From Reality to the Virtual World*, no. January: 226–37. <https://doi.org/10.13166/wsge//xux11897>.
  16. Kaur, Sukhvinder, and Pragya Madan. 2017. “Digitalization in India: Cashless, Paperless & Faceless.” *Asian Journal of Multidimensional Research (AJMR)* 6 (6): 5–14. <https://www.indianjournals.com/ijor.aspx?target=ijor:ajmr&volume=6&issue=6&article=001>.
  17. Kemmerer, Richard A. 2003. “Cybersecurity.” *Proceedings - International Conference on Software Engineering*, 705–15. <https://doi.org/10.1109/ICSE.2003.1201257>.
  18. Koops, Bert-Jaap. 2012. “The Internet and Its Opportunities for Cybercrime.” *SSRN Electronic Journal*, no. 09. <https://doi.org/10.2139/ssrn.1738223>.
  19. Kumar, Suneel, and Shekhar. 2020. “Digitalization: A Strategic Approach for Development of Tourism Industry in India:” 93–108. <https://doi.org/10.1177/0971890720914111>.
  20. Mccarthy, John. 1998. “WHAT IS ARTIFICIAL INTELLIGENCE ?,” 1–14.
  21. Mukhopadhyay, Debabrata, and Arun Kumar Mandal. 2019. “Smartphone, Internet and Digitalization in India-An Exploratory Analysis.” *PRAGATI: Journal of Indian Economy* 6 (2): 22. <https://doi.org/10.17492/PRAGATI.V6I2.187355>.
  22. OECD. 2019. *Artificial Intelligence in Society*.
  23. Reddy, G. Nikhita, and G. J. Ugander Reddy. 2014. “A Study Of Cyber Security Challenges And Its Emerging Trends On Latest Technologies,” no. February. <http://arxiv.org/abs/1402.1842>.
  24. Setiawan, Nashrudin, Pipit buana Sari, Yossie Rossanty, Vita Cita Emia Tarigan, Pipit Buana Sari, Muhammad Dharma Tuah Putra Nasution, and Ilhamsyah Siregar Sekolah Tinggi Ilmu Ekonomi Profesional Indonesia. 2018.
  25. “IMPACT OF CYBERCRIME IN E-BUSINESS AND TRUST.” *Article in International Journal of Civil Engineering and Technology* 6 (7): 652–56. <http://www.iaeme.com/IJCIET/index.asp652http://www.iaeme.com/ijciet/issues.asp?JType=IJCIET&VType=9&IType=7http://www.iaeme.com/ijciet/issues.asp?JType=IJCIET&VType=9&IType=7>.
  26. Sihmar, Deepika, and Ravi Kumar Meena. 2019. “Digitalization In India : An Innovative Concept.” *International Journal of Engineering Development and Research* 7 (1): 452–56.
  27. Taddy, Matthew Alan. 2018. “The Technological Elements of Artificial Intelligence.” *Ssrn*. <https://doi.org/10.3386/w24301>.
  28. “UK and Allies Publish Advice to Fix Global Cyber... - NCSC.GOV.UK.” n.d. Accessed January 9, 2022.

<https://www.ncsc.gov.uk/news/global-cyber-vulnerabilities-advice>.

29. Weaver, Nicholas, Vern Paxson, Stuart Staniford, and Robert Cunningham. n.d. "Large Scale Malicious Code: A Research Agenda \* †."
30. Zhang, Bo Yun, Xi Ai Yan, and De Quan Tang. 2018. "Survey on Malicious Code Intelligent Detection Techniques." *Journal of Physics: Conference Series* 1087 (6). <https://doi.org/10.1088/1742-6596/1087/6/062026>.
31. Ziemianin, Karolina. 2021. "Civil Legal Personality of Artificial Intelligence. Future or Utopia?" *Internet Policy Review* 10 (2): 1–22. <https://doi.org/10.14763/2021.2.1544>.

## **PMJDY: Understanding its Benefits and Challenges in Implementing Financial Inclusion in India**

**Navsin Mistry<sup>1</sup> and Arvind S Luhar<sup>2</sup>**

<sup>1</sup>KPB Hinduja College, Mumbai

<sup>2</sup>PhD Research Guide, University of Mumbai, Mumbai & Chairman, Board of Studies in Accountancy, University of Mumbai

### **ABSTRACT**

Pradhan Mantri Jan Dhan Yojana scheme since it is implemented has delivered more than its objectives under which it was introduced. In spite of its excellent performance, still it is not untouched from challenges related to ICT, high cost and financial literacy. This article narrates the section of stake holders: bankers, regulators, intermediaries and technology providers who are largely benefited out of this novel scheme of financial inclusion in India.

Key Words: PMJDY, Challenges before PMJDY, Benefits of PMJDY, Financial Inclusion

### **INTRODUCTION**

Though PMJDY is not the first of its kind, it holds greater promise than its predecessors because it has more geographical widespread, provides greater benefits. The objectives of PMJDY are an integrated approach to ensure comprehensiveness financial inclusion of all the households in the country. The thought behind this scheme is to uplift those segments of the population who are devoid of the financial benefits and security that come along with various government schemes where any person can sign up for a bank account with minimum number of documents. Country like India where millions of people are living in rural areas that do not have bank account and can not avail the benefits that banking account can provide. They either save their money at home, or keep it with local money savers who are not regularized. This PMJDY scheme helped such persons and made it sure that they can get affordable financial products like bank accounts, remittances, credit services, pensions and insurance.

PMJDY scheme saw a record number of newly opened bank accounts with number of benefits such as no minimum balance, RuPay Debit card, insurance cover, overdraft facility, loan benefits and simplified mobile banking. In spite of gigantic success some key challenges which has impede the success of PMJDY are infrastructural issues pertaining within India, ability to keep the accounts 'live', lack of financial and technological literacy amongst the masses, duplication of accounts, managing the ecosystem of business correspondents.

Researcher has made an attempt to bring in one page some golden aspects of the schemes related to benefits of financial inclusion, challenges of financial inclusion and its implementation.

### **BENEFITS OF FINANCIAL INCLUSION FOR DIFFERENT STAKEHOLDERS:**

Financial inclusion is a win-win situation of opportunity for the left-outs, for the banks, for the intermediaries, and for the economy as a whole. Because of growing incomes, better access to information, technology, communications, improving awareness levels, aspirations of the left-outs are on the rise. Banks can ignore these opportunities at their own peril. The need of the hour is to awaken, start, and grab the opportunity aggressively.

**Benefits To the Banker:** At the onset, banks may feel that financial inclusion initiatives are a burden on them and it will prove to be a dent on their profits but the ground reality is altogether different. The various experience on beneficial inclusion should give them financial comfort. The benefits accruing to the bankers can be summarized as under:

- The low-cost deposits from the individuals will offer banks the opportunity to reduce their dependence on bulk volume of deposits from corporates, HNI's and better help in the management of the liquidity risks and the asset-liability mismatches.
- The deposits offered at low - cost will result in increased profits with the perspective from medium to long term.
- The banks will be able to harvest the benefit from the fortune at the bottom of the pyramid.
- It will create huge opportunity for the banks to go for cross-selling of asset products, micro-insurance covering both life and non-life, micro pension products, etc.

**Benefits to Users:** It is correctly stated that business opportunity is mostly dependent upon the accessibility to financial resources. Such accessibility is especially useful in urban centers where there are more opportunities. Financial inclusion provides opportunities to build on savings, make investments, and also avail credit at lesser cost. Some remarkable benefits to the new users of bank accounts are as follows:

- Access to insurance products will result as a cushion against unplanned expenses and contingencies in the form of emergencies such as health problems, illness, death of the family member or loss of employment.
- Help in coming out from the clutches of the moneylenders who are providing credit facilities from unorganized sector.
- Receiving social security transfers being paid in the form of old-age pensions, widow pensions, monthly aid to handicapped persons and other benefits accruing from the governments directly into their bank accounts without delays and lesser intermediaries as in case of collecting the benefits in cash.
- No need to travel faraway places and bearing the tantrums of intermediaries involved in the distribution of government subsidies and other benefit transfers.
- Facilitating economic independence and supporting the improved economic well-being.
- Customized bank accounts will solve the problem of sending the money periodically to the native place. Migrants living in urban centers would be able to send money quickly, effortlessly and without paying commission to the intermediaries.
- In the anticipatable future, access to credit, insurance, remittance, and overdraft facilities will be made available easily.
- The stronger desire for saving, let the money earn for you; a better life, better living, and real income.

**Benefits to Regulators:** The key role of regulators is to acutely observe the performance of the regulated. Some of the principal functions will prove to be the benefits being offered by the regulator are as under:

- Protect the interest of the consumer for if they feel safe and secure will help in making them to come towards formal financial system.
- Take steps for protecting the interest of all other stakeholders who works for ensuring financial inclusion for the country.
- See the activities in a broader perspective and give purposeful direction to achieve larger societal goals.

If banks can initiate financial inclusion on their own for both urban and rural area, then the regulator will be relieved of its social responsibility.

**Benefits to Intermediaries:** These are quite early days for financial inclusion in urban and rural area. Even the expanded list of intermediaries is yet to be field-tested at a reasonable scale. But one can safely determine that individual owner of Kirana stores / medical shops/ fair price shops; individual PCO operators; individual petrol pump owners; agents of saving schemes of government of India; agents of insurance companies will be increasingly used as intermediaries. These intermediaries stand to benefit by way of:

- Howsoever small it may be but the additional income will come to the intermediaries. This income will come without any additional investments.
- The financially excluded persons opening the account through them are likely to stick to them for their other needs. That way urban intermediaries stand to gain indirect benefits also.
- Working as extended hands of banks, intermediaries are more likely to earn better respect and dignity for them in society.

**Benefits to Technology Providers:** The major role of technology providers is to acutely observe the performance of the regulated. Some of the functions which can provide benefits for stakeholders are as under:

- The technology providers will widen the markets for smart cards.
- The sense of satisfaction by way of contributing to national social agenda.
- The opportunity of new business in technology driven environment will be created.



**Benefits to Society at Large:** The key role of regulators is to acutely observe the performance of the all stakeholders. This observation will help for providing the following benefits for the society at large:

- Will encourage both the central and state government to shift the subsidies distribution form indirect system to directly in the hands of the target groups by way of directly crediting the fund in their account.
- Distribution cost of subsidies as well as social security and social welfare payments will get considerably reduced.
- This will help in plugging the leakage in fund and reducing the corruption.

**Benefits to Government:** Financial inclusion will be to help the state and the central government in the following ways:

- Helps in removing the inefficiency and corruption from the system.
- Possibility of making social security and social welfare transfers such as old-age pensions, widow pensions, etc directly into the bank account of beneficiaries through electronic transfer. This will help in minimizing transaction costs.
- Accounts will also help in plugging leakage in the distribution network and this will benefit society at large.
- Likely to stop the leakage, over the next five years, the central government alone will be spending 11.5 trillion rupees on subsidies, including old-age pensions, health care, and national jobs for work programs. in the current scenario, 40% of this will be siphoned off by the system. If the same subsidies can be transferred directly into the bank account of beneficiaries, then this leakage can be stopped.

**Benefits to the Economy as a Whole:** Financial inclusion is likely to result in a number of benefits for the Indian economy as a whole. Some of the probable benefits are explained herein:

- An avenue which will help in bringing the additional savings into the formal financial and banking channel enhancing the collective economic resources.
- Probability due to higher incomes coupled with a reduction in cash economy can lead to overall economic growth and reduction in black money.
- Better possibility of unlocking the economic potential of the people residing in our nation.
- Possible to track individuals' financial history; better utilization of consumers protection mechanism and higher level of financial literacy.
- Chance to achieve faster growth in the country by way of including the mainstream of the country.

#### **CHALLENGES OF FINANCIAL EXCLUSION:**

Challenges that are hindering financial inclusion in India are varied. Overall, it was required to look at the challenges that hinders financial inclusion in India. Though big scale financial inclusion in the country is still at lower scale as the statistics provided are not convincing and promising over the extent of financial inclusion in the country. The largely stated challenges that were identified by many are the ones which hinder the effective financial inclusion:

**Lack of financial literacy:** In this, it was established that, lack of adequate financial education or knowledge about the various financial services along with lack of access to formal financial sector is amongst the challenge to the most of the Indians which consecutively affects the overall general beneficiaries' approach to finances. Fundamentally, it was apprehended that majority of individuals within the nation lacks information on even the basic financial services especially loans in terms of both access and repayments. Also, they seem to not have even the important knowledge on the essential requirements for securing such loans. Hence, due to these challenges, one of the elementary ways that can be used for improving people's accessibility to financial services is by providing education to the public, so that the wrong long stuck mentality can be removed on financial services offered to the public.

**Low technology (ICT):** Low technological advancement is the major problem faced due to not developed information communication technology infrastructure which is the reason for uneven distribution of information between the financial service providers and the beneficiaries of the financial services. In this challenge, the

banks must make significant improvements in various areas and in varied Management Information System. The improvements in ICT will help in uniting people in different geographical location.

**High costs:** Costs connected with the delivering essential financial services through traditional pattern is high. Other than delivering, the challenges that were highlighted were the costs of connecting to the customer and financial services operation cost. Along with this cost, the charges collected from the beneficiaries of the services such as the interest rates and charges of using ATMs and mobile banking services exerts pressure on the people which in return affects the usage of these services. Essentially, it was realized that the various charges that imposed on services being provided is making operation more difficult. In order to limit this, there is a need for harmonizing the overall service charges, thus that the beneficiaries can be secure in paying them without any much hesitation.

**Regulatory requirements:** Regulation framed requirements such as KYCs rules has been initiated to avoid money laundering and it can make it difficult for the poor people to open a basic saving bank account for, they may not have the required necessary documentation. At the same time, it has been observed that many poor people do not have any collateral security or the required credit record for availing credit. The regulation needs to be reframed in a manner which can help to include all strata of people in banking sector.

#### **CHALLENGES FOR IMPLEMENTING PMJDY:**

The PMJDY is an ambitious initiative taken by the government constantly by setting aggressive timelines and deliverables. The capability of the scheme's initiative is, to successfully endeavour the aim of providing comprehensive financial inclusion to each citizen depending on coherent and efficient implementation. Various agencies have identified various challenges which is summarized by KPMG and such others, key challenges which could hamper the success of PMJDY initiative. The six challenges are listed below:

**Infrastructural Issues:** There is a lack of physical and digital connectivity related infrastructure in hilly areas and hinterlands such as the North East Region, Uttarakhand, Jammu & Kashmir, and Bihar put forward a major hinderance in achieving financial inclusion for all. Digital and technological issues are prevalent and affects the banks range due to poor connectivity, power shortage, network outage, and bandwidth problems for managing costs of maintaining the infrastructure. This makes us to question that 'Whether or not our banks infrastructure is capable for providing banking facilities to our diverse and ever – growing Indian population?' According to 2011 census, only about 46,000 out of the 6,00,000 India villages have bank branches. That comprise of only 14 percent of the 1,60,000 ATMs are in rural areas. Electricity being amongst the basic requirement for banks operations, running the ATMs and network connectivity to operate, but the large parts of the developing country is suffering from limited or no accessibility to electricity. Again, as per the statistics provided by the Census of 2011, only 55 percent of rural households had access to the basic requirement electricity. The major problems seen with ATMs in rural area are that it either run out of cash or remain shut due to power outage. Infrastructural constraints in rural area can be understood by the finding that it takes around 8 hours for a faulty machine to be repaired in urban area whereas in rural areas it takes around seven to eight days. An analysis by KPMG states that branch network of banks, needs the government to provide them with major infrastructure especially to the public sector banks. Taking the various factors into consideration in present scenario, a cost effective, technical and economically business model should be implemented to wrestle the infrastructural challenges.

**Maintaining the accounts 'LIVE':** Another challenge that the previous banking inclusion initiatives such as Swabhimaan program and no-frills account initiative have faced problem of dormancy or limited number of transactions in the accounts opened newly. The present statistics reveals that increasing the transactions per account opened is a challenge. As per the data available on official PMJDY website, 67 percent of the 12.58 crore PMJDY accounts had zero balance until 2<sup>nd</sup> February, 2015 which started to decline in the second Phase. Villagers are not willing to travel to long distance for branches located far for depositing a small sum of money. It costs them half of their days' time and loss of a days' earnings for availing banking services. This makes long travel a serious accessibility concern to think over. On the flip side, the banks have to spend Rs. 100 to 150 per account on cost of holding camps, getting the necessary documentation, and the commission to be paid to the Business Correspondents who are authorised for opening accounts. The transaction per account must be increased using technology or Business Correspondents services, which will help in making the scheme financially sustainable for the Government.

The Government aims to route the direct benefit in the form of cash transfer, pensions, LPG subsidy, and other subsidies directly into the accounts opened under PMJDY, to make certain that the accountholders have an incentive to carry out the transactions on the account. Conversely, the sustainability and profitability of PMJDY

accounts cannot survive on welfare schemes only. It is believed by many financial and economic firms those other initiatives undertaken by the government like Make in India, skill India, etc needs to be linked with the platform scheme, the PMJDY. The scheme aims to build economic activities around rural villages that could help in generating employment opportunities. It is also necessary to make people aware through financial literacy programs about the benefits of saving and investment. As per the survey conducted in west Kenya by the Kenyan Government showed results that individuals who had better access to the formal savings account have led to an increase in the average daily investment in to the businesses by 38 to 56 percent.

**Financial and Technological Illiteracy:** Several initiatives have been initiated by the successive governments with a view of achieving financial inclusion but after all efforts more than 40 percentage of the population yet lacks the access to basic financial services like savings, investment, credit and insurance facilities. Financial illiteracy is a major roadblock. Financial services giant, Visa conducted a survey and revealed that around 65 percent of Indians are not financially literate. There is illiteracy as they suffer lack of awareness, basic knowledge and skills among the rural poor to make an informed decisions about savings, investments, credit and expenditure.

Providing banking facilities through the traditional branch led model to the uncovered areas is an expensive proposition for banks. With the introduction of technology in providing banking services to the last mile uncovered population is a boon. However, technology adoption for providing banking services to the masses is still at a very budding stage. Limited or no proper awareness about the financial products and services available along with security concern about online banking still continues. Educating the people on usage of ATMs, cards, e-banking is to be done promoting the secure manner of these options for transacting. All stakeholders, must keep financial literacy amongst their top priority, and should appropriately blend it with measures for consumer protection. It is strongly believed that financial literacy can be better achieved by including financial management as a part of the general education program in schools and colleges study material. Through media, educational camps, counselling centres, various campaigns and also through the use of innovative technologies simple messages in local language can be circulated amongst the rural people for creating awareness about financial product and services. Obtaining assistance from microfinance companies, Self Help Groups, FMCG companies having access to farmers and other financial institutions who are in constant contact with the weaker and underprivileged sections can play an essential role in increasing financial literacy.

**Duplication of Accounts:** The bait of getting an insurance cover, accidental death cover and overdraft facility may have been a factor for prompting people to open more than one PMJDY accounts in different banks by providing different identification documents like Aadhaar card, Voter Id card, PAN card - as there is no way of detecting duplicate accounts as a single centralised information sharing system is not maintained. Most of financial benefits and welfare schemes have struggled with on-boarding citizen information. An Aadhaar card linkage to the account of the beneficiaries is crucial for the success of the Pradhan Mantri Jan Dhan Yojana as then it is proceeded by biometric authentication which to a vary extend will eliminate the risk of duplication or fraud. However, implementing Aadhaar linkage at a national level will take some time. Hard - hitting account opening targets can be a reason for forcing the banks to neglect duplication, thus endangering the objective of the scheme. e - KYC an additional effort is an under - utilized technology. It is believed that a single centralised information sharing system must be established by all to weed out the issue of multiple accounts and the banks then can emphasis more on quality rather than being with quantity.

**Managing the scheme ecosystem by Business Correspondents Model:** Business Correspondents functions as intermediaries and representatives of the Banks in providing financial services to the unbanked. Currently, close to around 3.3 lakh villages are having business correspondent agents. Still, managing the assisted network-based ecosystem is a multifaceted and unwieldy task for the banks. Several bottlenecks of the Business Correspondent model have been seen in the past years: like

- Delay in disbursement of subsidies, benefits and remuneration granted under Direct benefit transfer schemes, MNERGA, pension schemes etc. to rural people.
- Only 2 percent commission is paid to the Business Correspondent as an incentive which leads misleading demands of commission from illiterate villagers for various transactions like depositing money, processing loans, withdrawal of money from account, without the bank's knowledge.
- Reputational risk is posed on the banking institution as the customer service provided by a Business Correspondent to the customers are found to be inadequate and inconsistent.
- Banks at times are not committed to monitor Bank Correspondents operations.

- No proper training is provided to Business Correspondent agent which effect their ability to deliver the services and handle the complaints.

As Business Correspondent model is key for connecting to the unbacked, it is elemental for PMJDY to overcome the above-mentioned shortcomings.

**Economic Burden:** Pradhan Mantri has launched the Jan Dhan Yojana as a bouquet of benefits linked to it like deposits, credit facilities, life insurance cover, accidental insurance over, direct benefit transfers and easy withdrawal by RuPay debit card. Keeping the accounts opened operative the bank offered direct cash transfer of welfare schemes in the accounts, kept added insurance claim system and sustaining the credit being provided by overdraft facilities making the accounts financially viable for banks and the Government. The proximate challenge for the banks is to device the plan by charting out a financially viable model for keeping the PMJDY accounts operative and providing the benefits attached to the accounts continuously such as to provide insurance cover and also card facility. There is the risk attached to the overdraft facility being provided could end up being the bad loans for banks as the scheme lacks its vision on spelling out as to how the banks can collect these bad debts. These bad loans can amount to a huge amount of non-performing assets for the banks. It can be quantified assuming that one account each for 75 million households, has an opportunity to avail an overdraft facility of Rs. 5,000 from these 60 percentages of the total households avails the overdraft benefit, amounts to Rs. 22,500 crores. Even the risk is weighted at 20 - 25 percentage, it would amount to Rs. 4,500 crores of non-performing asset. With instances of debt being waived in the past, people may end up considering these loans as freebies. Minimum balance deposited and maintained in the account and the number of transactions carried out in a year would determine the economic viability of this scheme. PMJDY is looked upon as a facilitator to attain financial inclusion. A wide range and thorough inclusive framework of Jan Dhan Yojana, with increase in financial literacy, improved technological infrastructure and self-sustaining Business Correspondent delivery model can result in better and effective financial inclusion. With firm determination and the ability, the challenges can be addressed and financial inclusion for all can be seen in the near future.

#### SUMMARY

The success of PMJDY will largely depend upon reaching the poorest of the poor in the country and end financial untouchability, in a country where 25 percent of the people live with an income of less than INR 40 per day. The critical aspects of the scheme are the delivery of banking services to the un-banked and under – banked considering the constrains of ICT, connectivity and financial literacy. The immediate need is to build economic activity around un-banked / under – banked villages so that the newly opened bank accounts remain active with regular transactions other than just Direct Benefit Transfers.

#### REFERENCES

1. Dr. Hire, R. Raval. (2015). “Shaping New India through Financial Inclusion in form of PMJDY”, *International Journal of Research in Humanities & Social Sciences*. 2 (5), 33 – 37.
2. Sanju, Verma, (15<sup>th</sup> January, 2022). “PM Jan Dhan Yojana: Redefining Financial Inclusion, the Narendra Modi Way”, *Digital India*, New18.
3. Rao, K. Srinivasa. (2018). “Financial inclusion in India: Progress and prospects”, *Idea for India*, International Growth Centre.
4. Jayasawal, Chand, Vikash. (2018). “International Journal of Trend in Scientific Research and Development”, 4 (2), 779 – 790.
5. Dr. K, Rakesh. (2017). “Implementation of Jan Dhan Yojana –Challenges and Prospects”, *International Journal of Management*, 8 (2), 150 – 160.
6. KPMG. (2015). “Transacting Jan Dhan Yojana”, 5 – 6.

## Portrayal of Human Relations and Emotions by Ruskin Bond

Sanchna Chopra and Vinaya Kumari  
Amity University

### ABSTRACT

Writers write not for fame or wealth but for self-actualization and to present their comments on the societal scenario around them. This paper explores Ruskin Bond's depiction of love as a reflected in his character's subconscious behavior. Bond's characters do not seem like characters, instead their relatability factor is so high that every reader finds a little bit of themselves in the characters. His characters feel like they are real people from the real world facing real challenges and feeling real emotions. The names of the characters are names we all have heard in our regular lives and the locations his stories are set in are commonplace. His character's real, mundane, at times uncomplicated monotonous lives reflect our trivial and beautiful lives and is what make his work approachable to all kinds of readers. This blunt, honest, and appealing portrayal of his characters is what made Bond stands out amongst his peer writers in these contemporary times. An idealist who writes like an optimist, finding the silver lining while acknowledging the greyness of the cloud it surrounds. This quality of subtly unraveling each layer of the reader's emotions is something even the finest of authors struggle with and thus makes him a master of his craft. Bond believes in art for art's sake and thus he presents life in all its glory with all its colors on display. This stark presentation of life's vices, follies, drawbacks, and the vulnerability of human character exhibits the balanced co-relation between Nature and humans as it is in the cosmos. What made him successfully convey his deep insight of humans without any alterations or exaggerated emotions was his unique methodology of maintaining focus on realistically portraying human nature, their ideas, thought process, and emotions, while staying true to his passion towards nature and each creature in it.

Keywords: Bondian Literature, Human Relationships, Intense Drive, Passion, Ruskin Bond.

### Ruskin Bond's Understanding and treatment of human emotions:

A human mind can experience around 34,000 emotions and very commonly more than one at a time. Emotions are a subjective state of mind which can be influenced or triggered by multitude of reasons. The written word for one is extremely efficient and capable of stirring up emotions and igniting the need to analyze, evaluate, and rethink everything we ever believed in. In fact, literary discourse is designed for this very purpose of arousing and giving shape to the reader's feelings. The one feeling that has over ages succeeded in evading all of mankind has to be love. Every author, poet, philosopher has tried to give an apt definition to this emotion, only to be contradicted by another. Love is the most misunderstood emotion out there that never takes one form or color, and yet we tend to focus on the intended bond amongst human beings. The contemporary world had shifted our focus inwards and encouraged self-love and learning to enjoy our own company, but in the process solitude and selfishness has also come tagging along. As natural and automatic an emotion love feels like, it takes work, unselfishness, and a vulnerability. Despite the harmonious nature of the emotion people fail to reciprocate the love and affection they receive and instead cater to their psychological turmoil.

Bond has the mastery on the creativity that emphasize on practical contemporary episodes unlike forecasting rebels and revolutions. His literary sense paves a reflective medium to convey his expressions in the most convincing form which are otherwise purely overlooked. Author's range of characters in his love-stories is very significant. He relates his love-feeling with the mind of his protagonists and transmits the character's feelings, hidden or not, and their conscience with a considerable ease without the aid of elated devices and literary terms. According to Robert Liddell, the real essence of the art of a novelist is to relate his identity with that of the character. The big source of character production has an impact on the author's own self. The author put himself forth in the shoes of other people and can see through their eye lens, and he may have some time to change his age, sex, social position and also to develop to the full every suggestion of every vice or virtue he may possess. Bond achieved an abundance of expression, emotional and spiritual intensity, and suggestiveness through his love-stories. As far as his love stories are concerned, he may seem to reign the literary world in his time. He is no stranger to human-sentiments at any level. The disturbing influence and sad plight of the lovers in his love-stories recur like in most Indian fiction. Once in an interview he was asked why do his love-stories usually end with a sad note? For which his answer was – "Those stories were most of the times written when I was quite young and romantic by nature...There are many famous love-stories which usually ended on a sad note. If they ended on a happy note, some of them were not quite so memorable." The treatment of love in his love stories, we find the author cleverly retains the temperament of love that showers beautifully in a natural realistic

manner. His views about the treatment of love are too firmly molded to alter. His love-stories have kept an exceptional charm and youthfulness. Neither fashion nor the changing trends in reading have created any serious effect upon them. He believed in optimistic endings and traditional story setting unless following the unities, plot, seriousness, and chaotic representation. Most of his literary text has simple and natural representation unlike narrating complex and confused plots. Thus, being a realistic writer, he never believed in a meta plot and unsolved chaotic structure. "He remarks that he believes he didn't have much of a personality but was always a person with strong likings and enough stubbornness to get his way while being old fashioned enough to believe in loyalty in friendships and despising money for money's sake. He was eager to discover himself and the nature around him and eager to express all his finding in a language he had come to love. Bond is intimately acquainted with the past of India which he had explored in documents, legends, and history and by discovering its latent presence in the manners, traditions, and languages he has given everything in reality with concrete form. No sort of alliteration and alignment has done by the writer. His mere intention lies on the narrative sequence. Unlike following the blind classical strategy given by Greek and Latin writers like Virgil, Ovid, Euripides, Bond has the concern towards his eloquent updated accent, simple precise style and portraying the human emotions as it is without elevated norms. In a press note by Miss Marry, the book reviewer and critic, after the publication of "The Room on the Roof", has given a noteworthy remark saying that Mr. Ruskin Bond, while really belonging to India saw it through the sharp and often satirical eye of a westerner, so that what Indian writers could not make intelligible to us, suddenly took center stage. At the same time Miss Marry also affirmed that Ruskin had risen above the consideration of religion, race and even money to choose the country he loved. In this regard he is truly Indian. The conventional treatment of love themes is not dealt by Bond in most of his stories. It is not necessary for him to take young heroes and young heroines in his stories to make them fascinating. The tone of the plots is not fanciful, at least in most of their parts. A psychological truth is always there in his treatment of love that is sufficiently deep and to a grasp of man's nature that is large and extended enough to satisfy the needs of our mind. Bond never seeks for complicated tangles of man-woman relationship which could sense in earlier British and many psychological interpretations too. His efficiency lies on treatment of considering emotions in the Indianness segment. He cautiously avoids triangular love knot, psycho-analytical issues and didactic principles. In certain cases, he desires to make a searching analysis of the characters especially females. He thoroughly depicted the sub consciousness and the inner consciousness of the human folk. He has the vivid sense of depiction and he has taken Lacans concept of interpretation related to intensified emotions. In most of his love stories the protagonist is usually a writer, a lonely and sad man. The pain of separation is necessarily put in his love-stories. Otherwise, Bond says that his love stories wouldn't have been remembered so far. In such stories the initiative for breaking the relationship usually comes from the women protagonist.

His keen focus on nature and its finest details highlights his observant nature which was never limited to his surroundings but also explored all worldly characters, and their role in their own perception. His realistic and genuine portrayal of his characters and the use of simple language makes his work accessible and easily prompts an attachment with the characters. Known for his clear, detailed and concrete narration, Bond's distinct writing style explores the depths of his characters through carefully crafted simple words. His work represents a sense of harmony across all beings and not only instigates an unassuming love for his characters but also manifests a deep instinctive love for fellow human beings. While Bond doesn't claim to be a philosopher nor is he a propagandist, but his work remains high in morality, imparts human values, and highlights its universal appeal and relevance. Bond's treatment of love is so pure that he very easily explored the tender love shared between a man and a woman or a parent and a child, across ages and circumstances. He paints his character's relationships in favorable colors which makes them well acceptable and relatable not just in India but across the world. The emotions, feel, love, and sense are highly modest and factual in his sense of expression and the inverted Narratology. He illustrates emotions in all its original unadulterated beauty and glory.

While Bond holds up the aura of a writer who imparts values and idealism, his approach towards human relations is very practical and understandable. Love as we all have heard holds no limit, and his protagonists also seem to be well aware of this. His protagonists are the masters of their own emotions and do not have any internal conflict rooting from deep rooted norms and values. They go far from the confines of social values and know no bar of caste, religion, age, or country, which often, ends their love story in separation with a sort of loneliness left behind. Those who find human relations intriguing and wish to understand the intricacies of bonded human relationship find bond's work very appealing. By the mere simplicity of his stories and the unbound emotional strata, bond's work receives international critical acclaim while reaching the commoners. He presents his many discoveries over the love relationship by feeding the love ad even the infatuation infused his stories and wishes to produce with great accuracy a deep-rooted reality which lies behind every such-

relationship. Throughout this journey bond never lets go of realism amidst all the smoke of sentiments and imagination.

Bond's most self-portraying novel *The Room on the Rooftop* is written in third individual portrayal in which he introduces himself through the hero Corroded. Whenever Corroded gets freedom to instruct English to Kishen-Kapoor's child, as wages for his work he is given a room on the rooftop in Kapoor's home. Mr. Kapoor is a drunkard individual and twenty years senior than his significant other Meena. Mr. Kapoor loves his better half definitely yet his energy for her was less than ideal as when the glow of old wine filled him with verse. She slowly comes extremely near Corroded. In a wilderness scene, Meena and Corroded react to one another's energy. "Corroded recalled that it was for this man Kapoor-this wimp, this self-stubborn, self-centered alcoholic that Meena had given her life, every last bit of it, devotedly she had stayed close by when she might have left, when there was no more battle in him and no more love in him and no more pride in him; and, had she left then, at that point, she would be alive, and he-he would be dead..." Bond features the delicateness of sentiment and extreme sensations of his characters. To support the anguish and dejection of Corroded, Bond presents a gadget in the story as Meena Kapoor's sad passing. She is twisted away from Corroded by a deadly fender bender while Kapoor's ventured out down to Delhi from Dehra in mission of a task. Corroded defeats by a sensation of weakness and pointlessness, and of the insignificance of life.

Through his energetic romantic tales, Bond has grabbed the eye of the pursuers, it is just the start. It is his endurance and harsh consistency of direction that caused him to have a corpus of innovative romantic tales of adequate mass normally acknowledged quality. The idea of his love stories is pretty much as clear as could really be expected. He is an incredible author for he can channel his enthusiasm into the making of heart contacting romantic tales. His treatment of affection, in every one of his romantic tales, the end segment is practically something similar, prompting a dismal consummation. On which Bond himself offers his perspective: throughout a long composing vocation, it is unavoidable that an author will at times rehash the same thing or return to subjects that have stayed with him even as novel thoughts and details enter his brain. The significant thing is to continue composing, noticing, tuning in, and focusing on the excellence of words and their course of action of it as engaging him. Without a doubt! Love is excessively wonderful and incredible such that we as a whole wish to be contemplated, really focused on, and appreciated. The work additionally shows that communicating love in words or activities really makes good feel however excruciating feelings in the provider just as the beneficiary. Articulations of mindful, sympathy, and compassion can rouse these sentiments in others. In this way Ruskin Bond is a nonconformist who plans to achieve a change not just in the topic, structure, and the construction yet additionally on the attitude of the crowd. He effectively attempts to annihilate the outdated devotions, speculations, and furthermore generalized convictions. To finish up, Bond's treatment of affection is totally a kaleidoscope of human relationship. It projects both the excellence and corruption of human instinct and their enthusiastic conduct. Ruskin Bond's milieu as an author of fiction and brief tales is the family. In his accounts, he has dove profound into the mind of man - lady relationship, incorporating the whole mankind. As a matter of fact, Bond is attempting to accomplish it in his accounts, what he truly couldn't get in his life. His life has been long adventure of the quest for the original mother figure and genuine romance. His whole scholarly works takes individuals to an excursion. It's an excursion into oneself and one's secret mind. It assists with inciting humanly nature - as human as could really be expected.

## REFERENCES

1. "An Interview with Ruskin", taken by the research scholar on March 29, 2003 at Mussoorie.
2. Ruskin Bond : "The Young Rebel", Scenes from a Writer's Life. (New Delhi : Penguin Books India, 1997), p.78.
3. Ruskin Bond : "The Room on The Roof", Collected Fiction (New Delhi: Penguin Books India, 1999), pp.612-613.
4. Ibid., p.630.
5. Ruskin Bond : "Flight of Pigeons", Collected Fiction (New Delhi: Penguin Books India, 1999), p.896.
6. W.H. Hudson : An Introduction to the study of Literature, pp.160- 161.
7. M.K. Naik : Perspective on Indian English Fiction (Delhi : Abhinav Pub., 1985), p. 214.
8. Ibid., p.55.
9. Ruskin Bond : "A Love of Long Ago", The Night Train At Deoli And Other Stories (New Delhi : Penguin Books India, 1988.) p. 243.

## Resilience and Depression among Diabetic and Non-Diabetic Individuals

Maria Varisa Sequeira and Shivakumara K

Department of Psychology, Karnatak University, Dharwad, India

### ABSTRACT

Diabetes is a chronic metabolic condition marked by high blood glucose (or blood sugar) levels. Individuals with diabetes are found have higher depressive symptoms. However, resistant behaviours are found to defend against depression, and resilience can enhance the likelihood of not feeling depressed. Thus, the present study aims to understand the levels of resilience and depression among diabetic and non-diabetic individuals as well as the relationship between resilience and depression among diabetic and non-diabetic individuals. The study hypothesized that diabetic and non-diabetic individuals differ significantly on resilience and depression and resilience and depression are significantly correlated. Through purposive sampling method, 65 diabetic individuals and 60 non-diabetic individuals from Goa were selected for the study. The Resilience Scale (Vijaya Lakshmi & Narain, 2017) and Beck's Depression Inventory (1996) were used to assess the levels of resilience and depression respectively. The findings of the study indicate that diabetic individuals have significantly lower resilience, perseverance, composure, self-reliance and faith than the non-diabetic individuals. Diabetic individuals were also found to experience higher depression than the non-diabetic individuals. There exists a significant positive relationship between resilience and its dimensions, perseverance, composure, self-reliance and faith among the diabetic and non-diabetic individuals. However, there was no significant relation found between depression and resilience and any of its dimensions among the diabetic and non-diabetic individuals.

Keywords: resilience, depression, diabetic individuals, non-diabetic individuals

Resilience refers to positive adaptation, or the ability to maintain or regain mental health, despite experiencing adversity (Wald et al., 2006). Early resilience studies focused on certain abilities or assets that helped people survive adversity, such as intellectual functioning. The definition of adversity has evolved throughout time to encompass unfavourable life events like traumatic occurrences, poverty, homelessness, natural catastrophes, violence, war, and physical illness that are statistically linked to adjustment issues or subsequent mental illness (Herrman et al., 2011). Psychological resilience in the context of major depressive disorder refers to the net impacts of a number of psychosocial and biological variables that reduce the likelihood of onset or recurrence, reduce illness severity, or increase the probability or speed of recovery (Laird et al., 2019). Understanding the factors that determine our resilience to distress, and articulating what allows us to survive and bounce back and even flourish in the face of adversity, has received far less attention (Dowrick et al., 2008).

Diabetes is a chronic metabolic condition marked by high blood glucose (or blood sugar) levels, which can cause catastrophic damage to the heart, blood vessels, eyes, kidneys, and nerves over time. Type 2 diabetes, which affects mostly adults and arises when the body grows resistant to insulin or does not produce enough of it, is the most common. Type 2 diabetes has become much more common in countries of all income levels during the last three decades. Anderson et al., (2001) found that depressive symptoms occur at higher levels in patients with diabetes than in the general population. However, resistant behaviours are found to defend against depression, and resilience can enhance the likelihood of not feeling depressed (Edward, 2005). Thus, the present study aims to understand the levels of resilience and depression among diabetic and non-diabetic individuals. It also aims to understand the relationship between resilience and depression among diabetic and non-diabetic individuals.

### METHOD

#### HYPOTHESES

H<sub>a1</sub> Diabetic and non-diabetic individuals differ significantly on resilience.

H<sub>a2</sub> Diabetic and non-diabetic individuals differ significantly on depression.

H<sub>a3</sub> Resilience and depression are significantly correlated among diabetic individuals.

H<sub>a4</sub> Resilience and depression are significantly correlated among non-diabetic individuals.

#### Sample

Participants with age ranging from 30 to 60 years residing in North and South districts of Goa comprised the sample. Through purposive sampling method, diabetic individuals ( $n = 65$ ; 30 male & 35 female) and non-



diabetic individuals ( $n = 60$ ; 30 male & 30 female) were selected. For the sample of diabetic individuals, patients with type 2 diabetes were included in the study.

### RESEARCH TOOLS

Resilience Scale (Vijaya Lakshmi & Narain, 2017): The scale consists of 30 items. There are 4 dimensions to this scale: Perseverance, Composure, Self-Reliance and Faith. The test re-test reliability of the scale is 0.87.

Beck's Depression Inventory (1996): The inventory consists of 21 items, in which four response options are presented on a scale of 0 to 3. The test re-test reliability of the scale is 0.93.

### RESULTS

**Table 1:** Mean, standard deviation and  $t$  value of diabetic and non-diabetic individuals on resilience and depression

Variable	Diabetic ( $n = 65$ )		Non-Diabetic ( $n = 60$ )		$t$
	$M$	$SD$	$M$	$SD$	
Resilience	45.70	10.64	54.65	6.70	5.67***
Perseverance	46.80	13.0	53.46	7.16	3.99***
Composure	45.56	10.24	54.79	7.16	5.87***
Self-Reliance	46.54	11.26	53.74	6.71	4.38***
Faith	46.45	10.87	53.83	7.28	4.48***
Depression	54.91	10.01	44.68	6.78	6.73***

\*\*\* $p < .001$

The mean scores of diabetic and non-diabetic individuals on resilience are 45.70 and 54.65 respectively as depicted in Table 1. The  $t$  value ( $t = 5.67$ ;  $p < .001$ ) indicates that diabetic individuals have significantly lower resilience than the non-diabetic individuals. On the dimension of perseverance, the mean scores of diabetic and non-diabetic individuals are 46.80 and 53.46 respectively. The  $t$  value ( $t = 3.99$ ;  $p < .001$ ) indicates that diabetic individuals have significantly lower perseverance than the non-diabetic individuals. On the dimension of composure, the mean scores of diabetic and non-diabetic individuals are 45.56 and 54.79 respectively. The  $t$  value ( $t = 5.87$ ;  $p < .001$ ) indicates that diabetic individuals have significantly lower composure than the non-diabetic individuals. On the dimension of self-reliance, the mean scores of diabetic and non-diabetic individuals are 46.54 and 53.74 respectively. The  $t$  value ( $t = 4.38$ ;  $p < .001$ ) indicates that diabetic individuals have significantly lower self-reliance than the non-diabetic individuals. On the dimension of faith, the mean scores of diabetic and non-diabetic individuals are 46.45 and 53.83 respectively. The  $t$  value ( $t = 4.48$ ;  $p < .001$ ) indicates that diabetic individuals have significantly lower self-reliance than the non-diabetic individuals.

The mean scores of diabetic and non-diabetic individuals on depression are 54.91 and 44.68 respectively. The  $t$  value ( $t = 6.73$ ;  $p < .001$ ) indicates that diabetic individuals have significantly higher depression than the non-diabetic individuals.

**Table 2:** Coefficient of correlation between resilience with its dimensions and depression among non-diabetic individuals

Variable	Resilience	Perseverance	Composure	Self-Reliance	Faith	Depression
Resilience	1	0.840**	0.838**	0.797**	0.757**	-0.143
Perseverance		1	0.558**	0.631**	0.522**	-0.076
Composure			1	0.562**	0.523**	-0.156
Self-Reliance				1	0.443**	-0.202
Faith					1	-0.029
Depression						1

\*\*. Correlation is significant at 0.01 level

The coefficient of correlation values for resilience with perseverance, composure, self-reliance and faith among the non-diabetic individuals are 0.840, 0.838, 0.797 and 0.757 respectively. The correlation values reveal that there is a significant positive relationship between resilience and perseverance, composure, self-reliance and faith among the non-diabetic individuals. The coefficient of correlation for perseverance with composure, self-reliance and faith are 0.558, 0.631, 0.522 respectively, which reveals a significant positive relationship of perseverance with composure, self-reliance and faith. The coefficient of correlation for composure with self-reliance and faith is 0.562 and 0.523 respectively which reveals a significant positive relationship between

composure with self-reliance and faith. The coefficient of correlation for self-reliance and faith is 0.443 which reveals a significant positive relationship between self-reliance and faith.

However, no significant correlation was found between depression and resilience and its dimensions among the non-diabetic individuals.

**Table 3:** Coefficient of inter correlation between resilience with its dimensions and depression among diabetic individuals

Variable	Resilience	Perseverance	Composure	Self-Reliance	Faith	Depression
Resilience	1	0.839**	0.878**	0.823**	0.817**	-0.225
Perseverance		1	0.602**	0.616**	0.575**	-0.179
Composure			1	0.642**	0.686**	-0.243
Self-Reliance				1	0.524**	-0.158
Faith					1	-0.171
Depression						1

\*\* . Correlation is significant at 0.01 level

The coefficient of correlation values for resilience with perseverance, composure, self-reliance and faith among the diabetic individuals are 0.839, 0.878, 0.823 and 0.817 respectively. The correlation values reveal that there is a significant positive relationship between resilience and perseverance, composure, self-reliance and faith among the diabetic individuals. The coefficient of correlation for perseverance with composure, self-reliance and faith are 0.602, 0.616, 0.575 respectively, which reveals a significant positive relationship of perseverance with composure, self-reliance and faith. The coefficient of correlation for composure with self-reliance and faith is 0.642 and 0.686 respectively which reveals a significant positive relationship between composure with self-reliance and faith. The coefficient of correlation for self-reliance and faith is 0.524 respectively which reveals a significant positive relationship between self-reliance and faith.

However, no significant relation was found between depression and resilience and its dimensions among the diabetic individuals.

## DISCUSSION

Diabetes resilience is a new idea that can explain why and how some people do well with diabetes management, control, and health-related quality of life while others with comparable risk profiles struggle (Hilliard et al., 2012). The findings of the current study, which show that diabetic individuals have low resilience, highlight the necessity for diabetes patients to improve their resilience. Resilience is associated with factors directly prominent to physical illness such as self-care, health related quality of life, pain perception, illness perception, adherence with treatment and exercise adherence (Stewart & Yuen, 2002). The most crucial feature that individuals require for living their everyday lives with diabetes mellitus is support, and support from their closest family and the environment allows them to become resilient (Kusnanto et al., 2020). Diabetic individuals are also found to have lower perseverance, composure, self-reliance and faith. Religious/spiritual beliefs and practices are also found to influence a sense of self-reliance and promote one's perseverance to deal with diabetes via a biblical figure showing strength (Choi & Hastings, 2019). The physicians can also help patients prevent peril and preserve perseverance for staying safe and sanguine especially during the pandemic situation (Barengolts, 2020). Furthermore, yoga has been discovered to have enormous potential as a co-intervention in the enhancement of the quality of life for diabetic patients as well as to increase mental composure (Kalsi et al., 2017).

Depression is a common psychiatric morbidity among individuals with diabetes (Agbir et al., 2010; Campayo et al., 2011). According to Schabert et al. (2013), people with diabetes sense severe social stigma associated with their condition, which is not consciously corroborated by people who do not have diabetes. This stigma may also be a contributing factor for depression among the individuals with diabetes. People with diabetes who enhance their psychosocial and physiological well-being are more likely to flourish rather than succumb to depression (Bradshaw et al., 2007).

## CONCLUSION

The findings of the present study indicate that diabetic individuals have significantly lower resilience, perseverance, composure, self-reliance and faith than the non-diabetic individuals. Diabetic individuals were also found to experience higher depression than the non-diabetic individuals. There exists a significant positive relationship between resilience and its dimensions, perseverance, composure, self-reliance and faith among the diabetic and non-diabetic individuals. However, there was no significant relation found between depression and

resilience and any of its dimensions among the diabetic and non-diabetic individuals. The findings of the current study highlight the necessity for diabetes patients to improve their resilience. In this context, governments and health workers must explore health interventions to boost diabetes patients' resilience so that they can effectively manage their food, medicine, activity, and stress. Interventions to enhance resilience in people with type 2 diabetes have the potential to minimise complications and increase positive life outcomes.

## REFERENCES

1. Agbir, T. M., Audu, M. D., Adebowale, T. O., & Goar, S. G. (2010). Depression among medical outpatients with diabetes: A cross-sectional study at Jos University Teaching Hospital, Jos, Nigeria. *Annals of African Medicine*, 9(1).
2. Anderson, R. J., Freedland, K. E., Clouse, R. E., & Lustman, P. J. (2001). The prevalence of comorbid depression in adults with diabetes: a meta-analysis. *Diabetes care*, 24(6), 1069-1078.
3. Barengolts, E. (2020). Persevere or peril: Diabetes care in times of covid-19. *Endocrine Practice*, 26(6), 688.
4. Bradshaw, B. G., Richardson, G. E., & Kulkami, K. (2007). Thriving with diabetes: an introduction to the resiliency approach for diabetes educators. *The Diabetes Educator*, 33(4), 643-650.
5. Campayo, A., Gómez-Biel, C. H., & Lobo, A. (2011). Diabetes and depression. *Current psychiatry reports*, 13(1), 26-30.
6. Choi, S. A., & Hastings, J. F. (2019). Religion, spirituality, coping, and resilience among African Americans with diabetes. *Journal of Religion & Spirituality in Social Work: Social Thought*, 38(1), 93-114.
7. Dowrick, C., Kokanovic, R., Hegarty, K., Griffiths, F., & Gunn, J. (2008). Resilience and depression: perspectives from primary care. *Health*, 12(4), 439-452.
8. Edward, K. (2005). Resilience: A Protector From Depression. *Journal of the American Psychiatric Nurses Association*, 11(4), 241-243. <https://doi.org/10.1177/1078390305281177>
9. Herrman, H., Stewart, D. E., Diaz-Granados, N., Berger, E. L., Jackson, B., & Yuen, T. (2011). What is resilience?. *The Canadian Journal of Psychiatry*, 56(5), 258-265.
10. Hilliard, M. E., Harris, M. A., & Weissberg-Benchell, J. (2012). Diabetes resilience: A model of risk and protection in type 1 diabetes. *Current diabetes reports*, 12(6), 739-748.
11. Kalsi, A., Singh, S., Taneja, N., Kukal, S., & Mani, S. (2017). Current treatments for type 2 diabetes, their side effects and possible complementary treatments. *International Journal*, 10(3).
12. Kusnanto, K., Arifin, H., & Widyawati, I. Y. (2020). A qualitative study exploring diabetes resilience among adults with regulated type 2 diabetes mellitus. *Diabetes & Metabolic Syndrome: Clinical Research & Reviews*, 14(6), 1681-1687.
13. Laird, K. T., Krause, B., Funes, C., & Lavretsky, H. (2019). Psychobiological factors of resilience and depression in late life. *Translational Psychiatry*, 9(1), 1-18.
14. Schabert, J., Browne, J. L., Mosely, K., & Speight, J. (2013). Social stigma in diabetes. *The Patient-Patient-Centered Outcomes Research*, 6(1), 1-10.
15. Stewart, D. E., & Yuen, T. (2011). A systematic review of resilience in the physically ill. *Psychosomatics*, 52(3), 199-209.
16. Wald, J., Taylor, S., Asmundson, G. J., Jang, K. L., & Stapleton, J. (2006). Literature Review of Concepts: Psychological Resiliency (No. DRDC-CR-2006-073). Vancouver: British Columbia University.

## The Essence of Blended Learning: Challenge and Future

Nidhi<sup>1</sup>, Kshama Sharma<sup>2</sup>, Prachi Goyal<sup>3</sup> and Meghna Aggarwal<sup>4</sup>

<sup>1</sup>Gargi College, University of Delhi, India

<sup>2,3</sup>K.R. Mangalam University Sohna, Gurugram, India

<sup>4</sup>Deen Dyal Upadhyaya College, University of Delhi, India

### ABSTRACT

BLENDED learning is a perfect blend of a modern and traditional way of teaching. The COVID-19 indeed framed a situation to lock everyone in their houses and do all kinds of activities from their home including learning, which gave a major turn to the teaching-learning pedagogy. Now, teaching has adopted an approach that is more hybrid, more technical, and more complex. The study aims to understand the challenges encountered to blended learning including technological issues, content adaptability for blended learning and many more. In this paper, the focus is on the challenges faced by the teachers as well as by the students virtually. The New Education Policy also has a great impact on changing the way of imparting education. As, it is a way ahead as far as blended learning is concerned, therefore, understanding the prospects of blended learning and the NEP is also required.

Keywords: Blended Learning, Technology, Challenges, Future Prospect, New Education Policy, COVID 19.

### INTRODUCTION

BLENDED Learning and teaching refer to the mixture of face-to-face classroom learning and online activities. This approach of learning and teaching combines digital learning tools with traditional classroom face-to-face learning (Hrastinski, 2019). It is commonly used in higher education, with some academics calling it the "new traditional model" (Norberg, 2011) or the "normality" in course delivery. However, because of definitional vagueness and institutions' inability to track a creative activity that has often arisen organically, determining the precise degree of its expansion has been difficult (Oliver, 2005).

Students are not needed to be physically present in one location for the technology-mediated components of these learning activities, but they may be connected digitally through online communities. For example, in one blended learning course, students may attend a traditional classroom class given by a teacher while simultaneously completing online components of the course outside of the classroom on an online learning platform. Online learning experiences can supplement or replace classroom teaching time, and online learning can involve varying degrees of an engagement or just time alone in independent study and learning activities. Blended learning is also referred to as mixed-mode learning. These instructional design systems employ a variety of teaching and learning experiences and vary in design and implementation between teachers, programmers, and schools (Martha Cleveland-Innes, 2018).

Technology advancements have changed teaching and learning, as seen by research demonstrating the use of blended learning. This efficacy is essentially tied to the quality of the learning experience, which (Wend, 2006) defines as the range of experiences within the university's concerns in which students see and engage, consequently altering their learning chances. Some critical factors must be addressed to deliver excellent experiences for learners, such as technology, course structure, instructor, technical assistance, assignments (Lionarakis, 2003), student involvement, and learning adaptability.

Blended learning has been used in a variety of designs and has had a significant beneficial impact on the learning process (DeLacey, 2002) of Harvard Business School showed that when online sessions were introduced to regular courses, students not only learned more but their interaction and satisfaction improved as well. Furthermore, blended learning is excellent for students who reside distant from the institution or have other obligations that clash with on-campus class time. Distance learning programs may not provide the learning environment that students seek, or they may not provide certain degrees, such as those that involve experimental work.

Blended mode of teaching and learning was used since 2000 but the pandemic had forced everyone to go digitally. The COVID-19 pandemic is a major problem for education throughout the world since teaching must be done digitally to prevent the spread of the COVID-19 (Rully Charitas Indra Prahmana, 2021). The issue is that some students live in rural locations, yet learning in an interconnected world should be done electronically. This e-learning intends to retain communication with students, improve self-esteem, and boost students' confidence in their abilities amid the Covid-19 epidemic. During the Covid-19 pandemic, universities, too, used

digital media to facilitate student education. With the introduction of the Internet and the World Wide Web, the possibility for access to students all over the world has grown substantially. As a result, online education now offers a wealth of instructional resources in a variety of media and may facilitate both online and offline communication between professors and students, as well as amongst students themselves (Leili Yekefallah, 2021).

### REVIEW OF LITERATURE

A panel discussion was conducted in 2006 by (Alex Koohang and Johannes Britz). The discussion was on 'Hybrid learning: Advantages, Challenges, Design and Future Direction. The main aim of the panel was to highlight the 4 important points of hybrid or blended learning i.e., the benefits of hybrid or blended learning, the complications in hybrid or blended learning, hybrid or blended learning models, and the prospects of hybrid or blended learning.

Secondary research was conducted with a primary goal to investigate and analyze the available literature on blended learning to know how it has been studied and assessed by various writers working in this field (R.Jayanthi, 2019). Her literature focused on the significance and concept of blended learning and study was focused on the current state of Blended Learning and its prospects for the future. It had been concluded by her study that blended learning removed the cultural and physical barrier and provided flexibility to students and well as teachers.

Researchers (Alebaikan & Troudi, 2010) had investigated the nature of hurdles and issues experienced at Saudi institutions when implementing a blended learning method. An overview of the literature on the rationale and designs for blended learning, as well as the state of web-based education in Saudi higher education, is presented. Three major issues associated with implementing blended learning in Saudi higher education are addressed. The adaption of this feature in conventional university culture is a key problem to consider in the deployment of blended learning in Saudi institutions. Another problem that is mentioned is determining the best-blended learning design.

E-learning is an efficient technique of teaching that brings out the best in pupils. To determine students' attitudes regarding e-learning Radha (2020) collected primary data on a national and worldwide scale using Google forms, which included the student population from various schools, colleges, and institutions. The purpose of her research was to investigate the E-learning process among students who were acquainted with web-based technologies. It also aids in the discovery of solutions to improve students' self-study skills. The stratified sampling approach was used in this study, with a sample size of 175 people from all over the world. Her study's findings represented the influence of E-learning, as well as students' enthusiasm in using E-learning resources and their performance.

The purpose of the research done by (Bouilheres, Le, McDonald, Nkhoma, & Jandug-Montera, 2020) was to investigate the benefits of Blended Learning for students' learning experiences at an Australian university's offshore campus in Ho Chi Minh City, Vietnam. The displacement of material is the Blended Learning approach used on the university campus. They had mentioned that learning takes place not just in face-to-face sessions at a set time, but also in online spaces, where students may learn whenever and wherever they choose. The purpose of their study was to determine how beneficial and successful it was in increasing interactions between students and their classmates, professors, and course materials.

### RESEARCH OBJECTIVES

**The objectives of the study are: -**

1. To identify the advantages of blended learning.
2. To investigate the challenges faced by the learners and teachers in blended learning.
4. To study the future prospects of blended learning with the new education policy(2020)

This research is conducted primarily on Secondary sources. The data and information used in the research are collected from various journals, books, conference proceedings, articles, lecture notes, and various websites.

### Role of New Education Policy in Digital Transformation

Given the rise of digital technologies and the growing relevance of using technology for teaching and learning at all levels, from elementary to higher education, the following essential efforts are recommended by the New Education Policy:

- (a) Online education pilot studies: Appropriate agencies, such as the NETF, CIET, NIOS, IGNOU, IITs, NITs, and others, will be identified to conduct a series of parallel pilot studies to evaluate the benefits of integrating education with online education while mitigating the drawbacks, as well as to study related areas, such as student device addiction, most preferred formats of e-content, and so on. The findings of these pilot projects will be made public and utilized to drive continual improvement.
- (b) Digital Infrastructure: To address India's scale, variety, complexity, and device penetration, there is a need to invest in the development of open, interoperable, evolvable public digital infrastructure in the education sector that can be utilized by different platforms and point solutions. This will ensure that technology-based solutions do not become obsolete as technology improves.
- (c) Online learning platform and resources: Existing e-learning systems, such as SWAYAM and DIKSHA, will be expanded to give teachers an organized, user-friendly, and an extensive collection of supportive tools for assessing learners' progress. As the current epidemic has demonstrated, tools such as two-way video and two-way audio interfaces for holding online lessons are a vital requirement.

Martha Cleveland –Innes (2018) has divided blended learning into three main models, shown in figure 1 as follows:-

**Figure 1:** Models of Blended learning



**Model 1:** It depicts the blended presentation and interaction, which consists of activity-focused face-to-face sessions supplemented with online resources.

**Model 2:** It represents the blended blocks, which are the combinations of one-day or half-day intensive face-to-face meetings, weekly online tutorials/seminars for activities and interaction, and online information and tools.

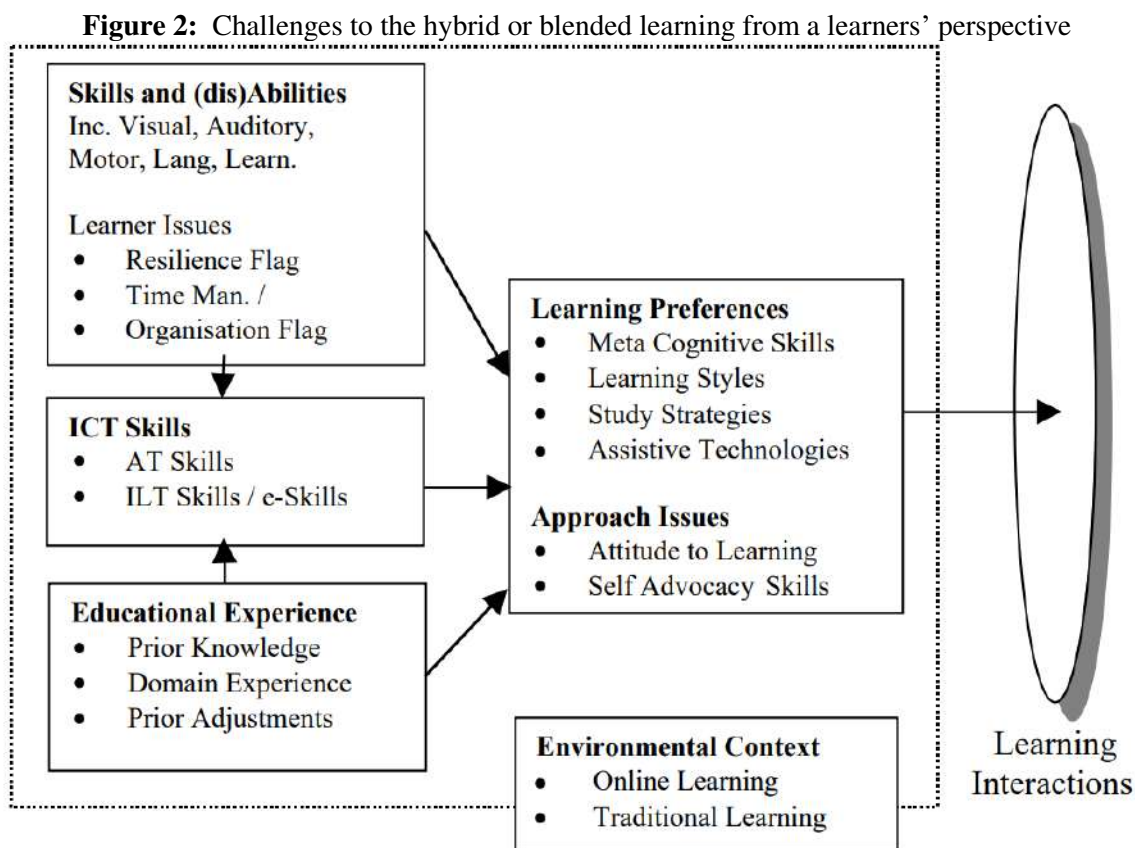
**Model 3:** it refers to complete online interaction. It means interaction is done with the help of online collaborations like online tutorials.

#### Advantages of Blended Learning and Teaching

Blended learning has so many benefits for teachers as well as for students. Individual students participate virtually together in an intellectual discipline as a learning activity, allowing them to collaborate at a distance. It has increased flexibility as technology-enabled learning allows students to learn whenever and wherever they choose, removing time and geographical limitations while still allowing for in-person involvement (Khawaja, 2013). The students and teacher can interact more as it provides a platform for increased involvement among students as well as between students and professors. It also enhances learning by adding new sorts of learning activities that boost engagement and help students reach greater and more meaningful levels of learning. It is capable of fostering a professional learning environment. Last but not least, it has the potential to save money and resources. (Poon, 2013).

#### Challenges to Blended Learning as a Learner's Perspective

The impediments of blended learning in higher education are massive which are consistently fostered by creative technical advances and engagement through conventional learning venues, which emphasizes blended learning's transformative power. E. A. Draffan & Peter Rainger (2006) has beautifully described the challenges from learner's and teacher's point of view with the help of figure 2 as below:



The figure suggests that the student's physical and cognitive abilities and capacities, attitudes, coping techniques, previous knowledge, and technological competency may all lead to obstacles in a blended learning situation. These difficulties can arise if a student's specific physical consensus and perceptual abilities are not taken into consideration while preparing the learning and teaching environment, interactions, and activities.

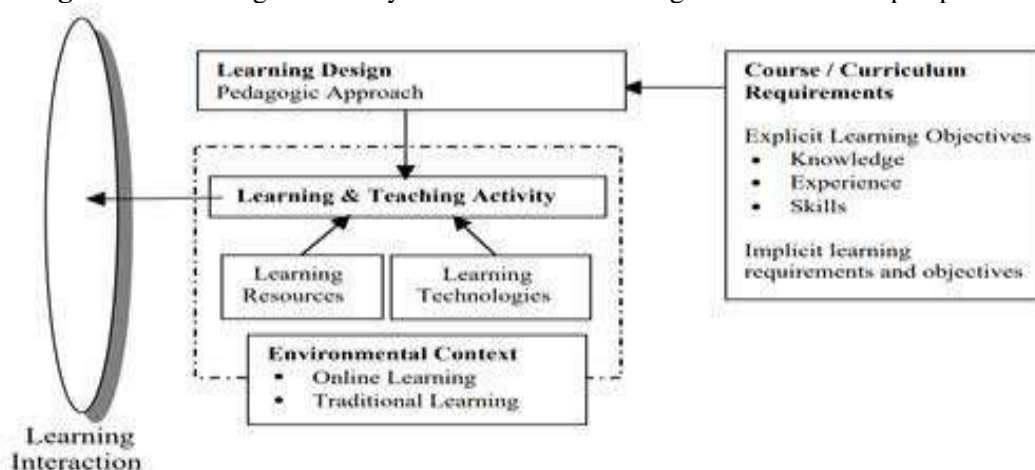
In any blended learning environment, a learner's competency with information communication technology (ICT) is as vital as their attitudes, motivation, and comprehension of e-skills and e-learning capabilities. But, if there is a lack of e-skills and e-learning competencies then students may feel dubious or confused with the ample information available; likewise, if ICT skills are weak, it makes content interaction limited. In short, all these basic incapacities make the situation jeopardized (Rainger, 2006).

**Inadequate self-pacing and self-direction:** Learner freedom and management are both required and encouraged in online learning. According to some studies, many students would view multiple weeks' worth of video lectures at once rather than following the course format. Students arrive at online learning with varying levels of learning competency; facilitating such learning self-management (Martha Cleveland-Innes, 2018).

### Challenges to Blended Learning as a Teaching Perspective

Any model of a teacher's perspective needs to be viewed from different levels of context and the different learning challenges. Their association determines by the level at which the teacher is working, it might be a course planning stage, course reviewing stage, or the course delivering stage. At the course planning stage, for example, it is important to ponder learner skills, which at the moment generally contain a student's incapacities but not necessarily their capacities or coping plans. In this case, quality assurance, educational standards and professional or vocational requirements also need to be taken into account. Likewise, at the delivery stage, a teacher should consider the learner's characteristics, accessibility requirements and assistive technology and so on. At this level, the accuracy in evaluation has its own impact on learners' preferences in light of the accessibility issues. The below-mentioned figure 3 provides a procedural explanation about the learning design, learning and teaching activities, resources and technologies, online and traditional learning environment, and overtly about the explicit and implicit learning objectives like knowledge, skills and experiences from a teacher's angle and challenges faced by them during the formulation of teaching pedagogy and strategies.

Figure 3: Challenges to the hybrid or blended learning from a teachers' perspective



For learning design, course necessities can be placed outside the environmental context box, as it is important to decide on the use of a specific learning environment with its associated interactions and activities to fulfill the needs of a learning objective, rather than forcing the learning objective to fit into a pre-defined environment with a set of rigid exercises (Rainger, 2006). The major challenge faced by the teachers is a lack of knowledge, quality control, and educational standards regarding ICT. Therefore, to facilitate inclusive learning, we need to ensure students can interact successfully with the technologies, themselves (through reflection), peers, teachers, support workers and learning materials. This means that the key issue in guaranteeing inclusive learning is the identification of any challenges to learning posed by the learning interactions.

However, concerns remain that the present models and tools do not target e-skills and e-learning aspects of a blended learning environment with sufficient rigor. It is felt that it is important to investigate micro-scale accessibility issues from the macro perspective of the learner's overall learning experience and suggest adjustments that include practical (e.g. working in pairs) and/or pedagogic changes to the learning activity without compromising the learning experience or academic probity; for instance, changing the interaction requirements to an appropriate alternative possibly in different learning and teaching environment, (Rainger, 2006).

### FUTURE PROSPECTS

Blended learning environments (BLEs) hold great potential for the future of higher education and business training. With the growing availability of technology and network connection over the last decade, the use of BLEs has progressively expanded (R.Jayanthi, 2019).

The future appears to be becoming more digital, wireless, and networked. Along these lines, it is expected that the rationale used to support web-based courses would soon be reversed. Previously, it was believed that little, if any, effective training could take place online. Many educators, maybe the vast majority, were skeptical about online technology replacing face-to-face education. It is expected that in the future, the change will be in the other direction (Alex Koohang and Johannes Britz, 2006).

### Road Map with New Education Policy

As per the new education policy, the current surge in infections and pandemics mandates that we be prepared with alternate forms of quality education whenever and wherever conventional and in-person modes of education are not available. In this sense, the National Education Policy 2020 emphasizes the necessity of exploiting the benefits of technology while also noting its inherent hazards and perils. It advocates for properly designed and adequately sized pilot projects to establish how the benefits of online/digital education may be realized while addressing or limiting the drawbacks. Meanwhile, existing digital platforms and continuing ICT-based educational efforts must be enhanced and extended to address present and future difficulties in delivering excellent education for all.

### CONCLUSION

It has been concluded by the research that blended learning and teaching have improved the way of imparting education. The prevailing pandemic situation has forced us to go digital. So, schools and colleges have changed the way of providing education, i.e., via online platforms such as Zoom, google meet, Microsoft, Webex, and many more. Blended learning helped the students who are far from the colleges and schools as they are not



supposed to be physically present, they get education by sitting at home. The students also get benefitted that they can do extra courses just through the use of technology. This will help them in improving their skills. Technology has provided students as well as teachers to communicate via communication apps. There are so many challenges faced by the teachers as well as the students in blended learning but at last, it helped both. The spreading of the deadly virus has enforced us to go for a blended model of education.

## REFERENCES

1. Alebaikan, R., & Troudi, S. (2010). Blended learning in Saudi universities: challenges and perspectives. *The Journal of Association for Learning Technology*, 18(1), 49 - 59. doi:10.1080/09687761003657614
2. Alex Koochang and Johannes Britz, A. K. (2006). Panel Discussion Hybrid/Blended Learning: Advantages, Challenges, Design, and Future Directions. *Informing Science and IT Education Joint Conference*, (pp. 25 - 28).
3. Bouilheres, F., Le, L. T., McDonald, S., Nkhoma, C., & Jandug-Montera, L. (2020). Defining student learning experience through blended learning. *Education and Information Technologies*, 3049 - 3069.
4. DeLacey, B. a. (2002). Case study on technology and distance in education at the Harvard Business School. *Educational Technology and Society*, 5(2), 13 - 28.
5. E. A. Draffan & Peter Rainger (2006). A model for the identification of challenges to blended learning, *ALT-J*, 14:1, 55-67, DOI: 10.1080/09687760500479787
6. Hrastinski, S. (2019). What Do We Mean by Blended Learning? *TechTrends*, 63(5), 564-569. doi:10.1007/s11528-019-00375-5
7. Khawaja, M. A. (2013). Can more become less? Effects of an intensive assessment environment on Students' learning performance. *European Journal of Engineering Education*, 38(6), 631 - 651.
8. Leili Yekefallah, P. N. (2021). Factors related to students' satisfaction with holding e-learning during the Covid-19 pandemic based on the dimensions of e-learning. *Heliyon*. doi:10.1016/j.heliyon.2021.e07628
9. Lionarakis, A. a. (2003). The quality of the learning experience: A comparative Study between open distance and conventional education. *Turkish Online Journal of Distance Education*, 4(2).
10. Martha Cleveland-Innes, D. W. (2018). *Guide to blended learning*. Commonwealth of Learning.
11. Ministry of Human Resource Development (2020). *New Education Policy*. Government of India. [https://www.education.gov.in/sites/upload\\_files/mhrd/files/NEP\\_Final\\_English\\_0.pdf](https://www.education.gov.in/sites/upload_files/mhrd/files/NEP_Final_English_0.pdf)
12. Norberg, A. D. (2011). A time-based blended learning model. *On the Horizon*, 19(3), 207- 216. doi:10.1108/10748121111163913
13. Oliver, M. &. (2005). Can 'blended learning' be redeemed? *e-Learning*, 2(1), 17 - 25.
14. Poon, J. (2013). Blended learning: an institutional approach for enhancing students'. *Journal of online learning and teachings*, *Journal of online learning and teaching*, 9(2), 271-288.
15. R.Jayanthi, D. (2019). A Study about Blended Learning - Its importance and Concept. *International Journal of Scientific Development and Research*, 4(4), 387 - 397.
16. R.Radha, K. D. (2020). E-Learning during Lockdown of Covid-19 Pandemic: A Global Perspective. *International Journal of Control and Automation*, 13(4), 1088 - 1099.
17. Rully Charitas Indra Prahmana, D. H. (2021). Community radio-based blended learning model: A promising learning model in remote area during pandemic era. *Heliyon*. doi:10.1016/j.heliyon.2021.e07511
18. Wend, P. (2006). Towards a joined-up student learning experience at Oxford Brookes University. *Brookes eJournal of Learning and Teaching*, 2(1).

## Stain and Pain of Liam in *Luna* by Julie Ann Peters

Mariena Kamala Brinda Noel S<sup>1</sup> and R. Jayakanth<sup>2</sup>

<sup>1</sup>Holy Cross College (Autonomous) Tiruchirappalli, Tamil Nadu, India, (Affiliated to Bharathidasan University, Tiruchirappallinand Tamil Nādu), India

<sup>2</sup>St. Joseph's College (Autonomous), (Affiliated to Bharathidasan University, Tiruchirappalli Tamil Nādu), India

### ABSTRACT

This paper deals with the pain of LUNA who is originally known as Liam in the morning and turns to be a girl at night. The pain and the insults he faces to fit into his identity and the support that he gets from his sister is what it talks about.

The narrative technique employed in *Luna* is first person and limited. The narrator is Regan, a sixteen – year old girl; whose brother is a transgender and wants to undergo surgery to transform himself as a female. It focuses on Regan's struggle to accept Liam's plan of transition and the difficulties she faces in the course of time to maintain its secrecy. It also focuses on how Liam / Luna is mostly reliable in regards to what Regan sees and knows, but there are circumstances where her observations are proven to be inaccurate.

“An exquisite and delicate creature, unfolding her wings and flying away. Except in Luna's case, the butterfly is forced to rein in her wings and reinsert herself into cocoon every day. Every single day she has to become this shell of a person”. (Peters .126)

The entire family is aware of Liam and is different towards him. Regan's father actually confronts Regan about Liam, asking her if she happens to know whether Liam is a gay. Regan answers, truthfully, that Liam is not a gay, but she thinks about how he does not want to be a boy like because he truly thinks himself as a girl. It makes a split between gender identity and sexual orientation, arguing that attraction to a particular gender and one's own sex are not enough to account for the complexity of the (sexual) self.

The replicate use of pronounce refers to the despite the layering and construction, as an embodiment of the self, Liam as “Liam. He let a short laugh. Who's that? A caricature I've creator. A puppet, a mime, a cartoon character. I'm this male macho-version of a son that dad has in his head”. (Peters 20). He always tries to be a son as his father wishes but he has only been a puppet in his hands who dances to its master's tunes. Liam at times laughs at himself thinking of his self and his identity.

This explains that transgender in *Luna* finds out that Liam O'Neil is an example of XYY variation chromosomes and to culture and brains structure of causes. Though Liam is an object of abusing and getting anxiety disorder, he compensates it with Luna as a girl and reaches his goal in life.

The other identification of transition is intense desire to participate in the stereotypical games and past times of other sex. It can be diagnosed in Regan's slums party. When Liam looks into Aly's multi-coloured toenails, he breathes and admires at it as saying 'cool'. Excitement is often associated with forgetting oneself and losing control. The change is visible and noticeable when Liam throws his arms in the air. He begins to gyrate his lips in double, triple time to the beat. The participation of Liam into slumber's party clearly shows the identification of the persistent cross-gender. Another example of his change is, when playing with Samantha doll he intensely needs to play the mother role. Young Liam admires daddy but wants to be the one who gets surprise and privilege like mommy. The attitude of Liam is shown in his desire of passing time of the other sex when he dresses and redresses the Samantha doll.

Liam has no boyfriends. His mother admits it which reflects on the preference for playmates of his other sex. Liam describes in a weird voice of changing into other sex and also had a desire of dating with boy. Liam's tone of unravelling by his own words were: “Liam grabs his penis and starts to pull”. “Take it off”, he says, almost in whisper. He sloshes toward Katie and repeats, “Take it off”. (Peters 226).

The above lines designed that Liam reflects his assigned sex. The crying proofs in this novel show that he was shocked. It is Luna who is oppressed with father's measure. As the girl inside him, does not like male activity. It is obvious that Liam cannot participate with rough tumble game of boys that is baseball which his dad wished to do, but according to his father he is a boy who is supposed to fulfil his father's wish.

The first social impairment is the school and the second is home. The statement between Liam and his father destroys the relationship of son and father. Liam's father wants Liam to be like other kid, normal and happy. He

worries that Liam does not idolize him like how he idolized his father years ago. Though Liam respects his father in a great manner, he always wished for being Regan, a girl that knows pretty inside and outside. These things emerge as a match with the disturbance manifested by symptoms such as preoccupation with getting rid of primary and secondary characteristics of Liam.

Since it is a literature work, the background of biological differences and natural order cannot be analysed. Due to variation of chromosomes, Liam does not respond to his testosterone and is not interested in female but, in the variation of natural order. Liam is genetically different and identified as transgender. It also depends upon the different cultures where it varies in the definition of masculine and feminine. Some cultures look at people and some have created specific ways for people to live in the roles that are different from that assigned to them at birth.

The people to live in the roles that are different from that assigned to them at birth. The people only accept two genders, masculine and feminine but transgender will be in harassment. In this novel, the harassment that was experienced by Liam is that Hoyt Doucet who suspects Liam and the other is to notice that, people at Taco Bell restaurant notice, Liam is a boy who is wearing girl's dress. It seemed to them as disgusting and looking.

Transgender will not fit anywhere, because gender is followed by language. Likewise, boys were called to be handsome as well as girls pretty, but for transgender there is nothing like that. No survival way in the society. As Susan Stryker explains these variations as, "It is not be crossed as same as clothing, behaviour and attitude though people only use boy and girl language".

The most important thing of transgender is intelligence and who are more obvious from their earlier memories. This shows up their identity. Though this gender identity is an innate part of them, an integral part of who they were born to be. Liam shows up his identity by saying about these violations as: "There was no place for him in the world. That he didn't fit anywhere. He really was off the scale. Boy by day, girl by night. Except he was girl by all the time, inside. His body didn't reflect his inner image. His body betrayed her". (Peters 51).

Transgender people who are employed mostly feel discomfort, ignorance and prejudice. A transgender social justice movement is one that addresses the specific kind of problems faced by them especially racism, poverty and other injustices. But racism and poverty were not in Liam's life, the one positive thing is that being transgender who was born genius. Though he is a transgender he worked in many places. The major difficulty of Liam was being close with friends and relatives.

Luna offers a unique view point into the process of transitioning and what it's like to come out as a teenager. We get to see the whole process in all its glory and pain and while doing so, thinking about gender in our society. Luna is sometimes a difficult book to read, in which Liam reveals his vulnerability and pain. Luna is a complicated novel dealing with complex issues and characters. It may be the first young adult novel to really deal with transgender issues, and as such, it offers an important opportunity for new dialogues and discussion.

Liam puts in lot of efforts to project his true self to the world. Luna under the garb of Liam, hampers his spirit. He camouflages to Luna whenever he finds time. In precise, he feigns as a boy and lives as a girl. Liam as Luna invariably has the fear of being secluded from the conventional society. Hence, this fear makes the metamorphosis slow and painful. Living every second of life with juggling self-identity is a solemn stress. In this world, the masculine and feminine people have their identity of their own-selves but the third gender that is transgender does not have identity. Luna who wants to prove her own self in this idealized society wants to be shown that she is a third gender.

Through this novel, we get to understand that being a transgender is nothing strange. Even a transgender deserves a life of a normal human being. There is nothing absurd in him, we should understand their emotions and must be empathetic. The novel instigates the idea of togetherness, and everlasting relationship. It also inculcates hope and belief in humanity. Through this novel, we get to know how tough is to register one's identity in the society. We always are the victims to the society's expectations. It requires time to come out of the shells and stay stabilized.

To be precise, the novel is a search for gender identity. We pine and root for Luna as we pervade deep into the novel. It is not just Luna who metamorphoses, but the readers too who undergo the wave of transition during the course of novel. By the Aristotelian terms, we undergo catharsis, or in simpler terms, purgation of emotions. The novel gives the sublime joy to the reader.

**REFERENCES**

1. Bode, Carl. High Lights of American Literature. Materials Branch, 1981.
2. Peters, Julie Anne. LUNA. Little Brown and Company, 2006.
3. Stryker, Susan. Transgender History. Seal Press, 2008.
4. Vanspansckeren, Kathryn. Outline of American Literature. USINFO Publications, 2006.

## Green Chemistry in Nanoparticles Catalysis

Prasad Indradeo and Agrawal Seema

Department of Chemistry, Dr. A. P. J. Abdul Kalam University, Indore, MP, India

### ABSTRACT

Nanoparticles of copper oxide could be used in a variety of catalytic applications. Copper salt was chemically reduced by utilising hydrazine hydrate as a powerful reducing agent in a microwave-aided synthesis process. It was determined that copper oxide nanoparticles were well disseminated in the synthesised catalyst. The ecologically friendly solvent systems, green synthetic techniques, and gentle reaction conditions all contribute to the manufactured copper oxide catalyst's many advantages.

Keywords: Catalysis, nanoparticles, copper oxide, hydrazine hydrate, microwave heating,

### INTRODUCTION

It was in 1991 that the phrase "green chemistry" was introduced to the scientific community, and its goal was to eliminate or reduce the use of hazardous substances. Currently, a variety of environmentally friendly techniques are being used to purify water, generate electricity, and manufacture items such as electronics, medications, plastics, and insecticides. As a general principle, any chemical substance has dangerous features because of its internal (molecular) structure, which can be altered. [1]

The chemical industry is well aware of the growing need for ecologically friendly procedures. The transition from traditional conceptions of process efficiency that place a heavy emphasis on chemical yield to ones that place a premium on reducing waste at the source and avoiding the use of poisonous and/or hazardous substances demands a paradigm shift. Anastas of the US Environmental Protection Agency invented the phrase "green chemistry". [2] Since the establishment of the "US Green Chemistry Program" by the EPA, events such as the Presidential Green Chemistry Challenge Awards and the annual Green Chemistry and Engineering Conference have taken place under this moniker. Green chemistry research was already taking place in the early years of the twentieth century, although the term had not yet been coined for it. A working definition of green chemistry can be summarised thusly: Environmentally friendly methods of producing and using chemical products, such as green chemistry, aim to minimise waste and avoid the use of harmful or dangerous chemicals.[3]

Green chemistry addresses both chemical products and the methods in which they are made. The latter is the focus of this book, i.e., the product is predetermined, and the purpose is to devise an environmentally friendly method of manufacturing it. Green chemistry reduces waste at the source, rather than waste treatment, which is the major goal of green chemistry (end-of-pipe solutions).[4]

### MATERIAL

#### • Experimental

There was no purification of any of the compounds employed. Experiments were carried out using pure ethanol and water that had been deionized to a purity of 99.9 percent. These materials were purchased from Sigma Aldrich, including palladium nitrate, copper (II) nitrate, hydrazine hydrate (80%), bromobenzene, and all other aryl halides and potassium carbonate.

#### • Copper Oxide Nanoparticle Synthesis

Sonication with 366 mg of copper (II) nitrate hemipentahydrate  $\text{Cu}(\text{NO}_3)_2 \cdot 2.5\text{H}_2\text{O}$  was performed for one hour. A further hour was spent stirring the mixture. A total of 400 l of hydrozine hydrate was added to the mixture after the final stirring phase. After that, it is heated in a microwave oven for 20 seconds before being filtered, deionized water washed, and then ethanol washed, before being dried in an oven until the catalyst's weight is constant.

#### • Characteristics of a Catalyst

In order to capture TEM images, an electron microscope such as the JEOL JEM-1230 was employed. Thermo Fisher Scientific's ESCALAB was used to conduct the XPS investigation. The X'Pert PRO PAN analytical X-ray diffraction equipment was used to measure the diffraction patterns at room temperature.

RESULTS

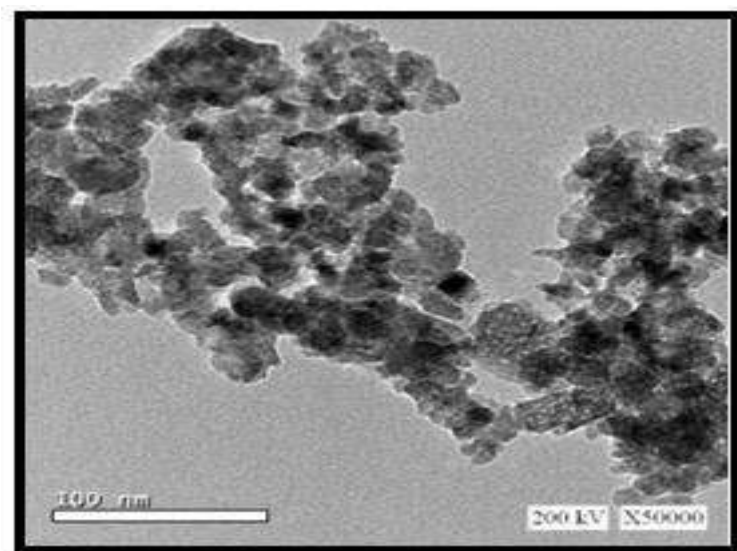


Fig 1: Shows CuO Nanoparticles Photographed With A TEM.

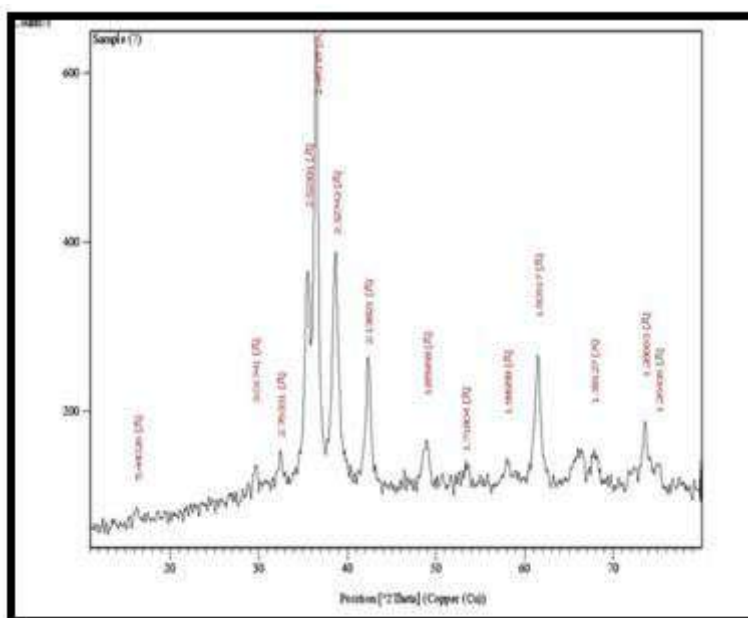


Fig. 2: Nanoparticles of CuO

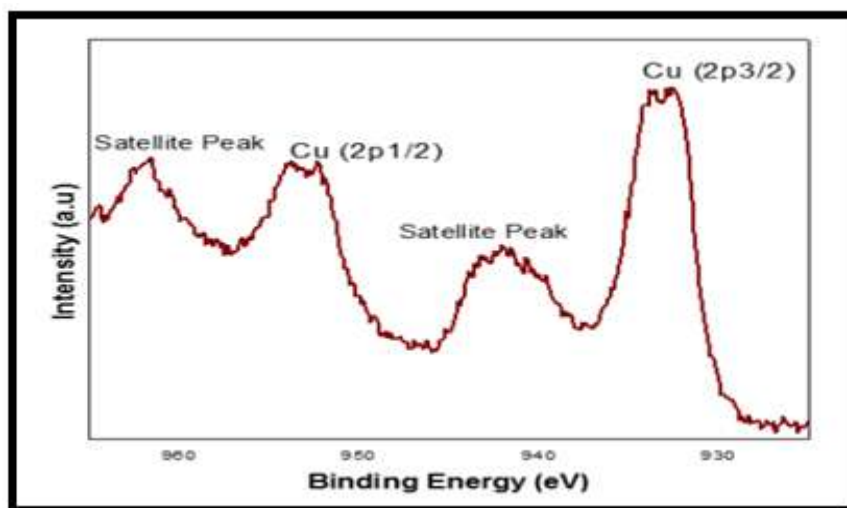


Fig 3. XPS (Cu2p) Of CuO Nanoparticles.

## DISCUSSION

Chemical and morphological features of CuONPs can be influenced by the technique of synthesis, which in turn can have an impact on the compounds' ecological identities and potential biological and catalytic applications. Due to their high growth rates, microbes, plants, and algae have all emerged as promising candidates for the production of nanoparticles. This biosynthesis of nanoparticles is cost-effective and simple to make. It is a good option. The biocidal properties of nanoparticles can be applied to a wide range of microorganisms, including viruses, fungus, and algae. Surface oxides can be more accurately and reliably analysed chemically with XPS than with XRD. The XRD diffraction pattern of microwave-prepared copper oxide nanoparticles is shown. Copper oxide catalyst (CuO) was further characterised by XRD patterns of the catalyst.

## CONCLUSIONS

Using microwave irradiation, a simple and effective synthetic technique was developed to produce highly active copper oxide nanoparticles as catalysts. Hydrazine hydrate is used as a reducing agent in the chemical reduction of copper nitrate salts in an aqueous mixture. Using TEM, XRD, and XPS, the newly synthesised CuO catalyst was studied and found to have a size range of 18–2 nm. We are currently working on the development of catalytic systems employing palladium and one of the most promising transition metals, copper, because of their abundance, low cost, versatility, less hazardous to the environment, and wide use in various applications in the field of catalysis.

## REFERENCES

1. Ajayi, B. Abiola, I. "Biosynthesis, characterization and antimicrobial Activity of gold nanoparticles from leaf extracts of *Annona muricata*", *J. Nanost. Chem*, Vol 9, Issue (2) , Page 111–117,2019.
2. A.S. Folorunso, O.T. Ademosun, "Instrumental characterization and antibacterial investigation of silver nanoparticles synthesized from *Garcinia kola* leaf", *J. Drug Deliv. Therapeut*, vol 9, Issue (6) , Page 58–64.
3. S.A. Akintelu, "Biosynthesis, characterization and antifungal investigation of Ag-Cu nanoparticles from bark extracts of *Garcinia kola*", *Stem Cell*. Vol 10 , issue (4) (2019), Page 30–37,2019.
4. Oyebamiji, E.A. Erazua, "Antibacterial potency of silver nanoparticles synthesized using *Boerhaavia diffusa* leaf extract as reductive and stabilizing agent", *Int. J. Pharma Sci. Res.* Vol 10, issue (12), Page 374–380,2019.
5. P. Khatereh,, "Green synthesis of Ni@Fe<sub>3</sub>O<sub>4</sub> and CuO nanoparticles using *Euphorbia maculata* extract as photocatalysts for the degradation of organic pollutants under UV-irradiation", *Ceram. Int*, Vol 45 , Issue (1), Page 17173–17182,2019.
6. S. Norzaee, B. Djahed, "Photocatalytic degradation of aniline in water using CuO nanoparticles", *J. Water Supply Res. Technol*, Vol 66, Issue (1), Page 178–185,2017.
7. M. Aminuzzaman, L.M. Kei, W.H. Liang, "Green synthesis of copper oxide (CuO) nanoparticles using banana peel extract and their photocatalytic activities", *AIP Conf. Proc*, Vol 1828, Issue (1), Page 1–5,2017.
8. E. Ayoman, S.G. Hosseini, "Synthesis of CuO nanopowders by high-energy ballmilling method and investigation of their catalytic activity on thermal decomposition of ammonium perchlorate particles," *J. Therm. Anal. Calorim.*, Vol 123, Issue (1), Page 1213–1224,2016.
9. M. Srinivasan, M. Venkatesan, V. Arumugam, "Green synthesis and characterization of titanium dioxide nanoparticles (TiO<sub>2</sub> NPs) using *Sesbania grandiflora* and evaluation of toxicity in zebrafish embryos", *Process Biochem*, Vol 80 , Issue (1), Page 197–202,2019.
10. S. Vasantharaj, S. Sathiyavimal, P. Senthikumar, "Biosynthesis of iron oxide nanoparticles using leaf extract of *Ruellia tuberosa*: antimicrobial properties and their applications in photocatalytic degradation", *J. Photochem. Photobiol. B Biol*, Vol 192 , Issue (1), Page 74–82,2019.
11. Tingting Jiang, "Facile synthesis and photocatalytic performance of self-assembly CuO microspheres, Superlattice". *Microst*, Vol 85 , Issue (1), Page 1–6,2016.
12. A.F. Fatah "Physical and chemical properties of LSCF-CuO as potential cathode for intermediate temperature solid oxide fuel cell (IT-SOFC), Malaysian", *J. Fund. Appl. Sci*, Vol 14, Issue (1), Page 391–396,2018.

13. Gerosa, M.; Bottani, C.E.; Caramella,. “Defect calculations in semiconductors through a dielectric-dependent functional: The case of oxygen vacancies in metal oxides hybrid DFT”. *J. Chem. Phys.*, Vol 143, Issue (1), Page 134-702, 2015.
14. Mehlomakulu, B.; Nguyen, T.T.N. “Identification of the active species in oxidation reactions on mixed oxide catalysts: Supra-surface or bulk-surface species”. *J. Catal.* , Vol 289, Issue (1), Page 1–10, 2012.
15. Fechete, I.; Védrine, J.C. “Nano-oxide mesoporous catalysts in heterogeneous catalysis. In *Nanotechnology in Catalysis: Applications in the Chemical Industry, Energy Development, and Environment Protection*”; Wiley-VCH: Weinheim, Germany, Vol 1, Issue (1), Page 50–89,2017.
16. Neri, G., et al., “Engineering of carbon based nanomaterials by ring-opening reactions of a reactive azlactone graphene platform”. *Chemical Communications*, Vol 51, issue (23), Page 4846-4849, 2015.
17. Kumar, S., et al., “Graphene, carbon nanotubes, zinc oxide and gold as elite nanomaterials for fabrication of biosensors for healthcare”. *Biosensors & Bioelectronics*, Vol 70, Issue (1), Page 498-503, 2015.
18. Beckert, M., et al., “Nitrogenated graphene and carbon nanomaterials by carbonization of polyfurfuryl alcohol in the presence of urea and dicyandiamide”. *Green Chemistry*, Vol 17, Issue (2), Page 1032-1037,2015.
19. Yan, J.M., et al., “Magnetically recyclable Fe-Ni alloy catalyzed dehydrogenation of ammonia borane in aqueous solution under ambient atmosphere”. *Journal of Power Sources*, Vol 194, Issue (1), Page 478-481,2013.
20. Elazab, H., et al., “Microwave-assisted synthesis of Pd nanoparticles supported on FeO, CoO, and Ni(OH) nanoplates and catalysis application for CO oxidation”. *Journal of Nanoparticle Research*, , Vol 16, Issue (7), Page 1-11,2014.



## **Impact of Health Consciousness and Food Safety Concern on Consumer Buying Behaviour – A Review on Organic Food Products**

**Tarun Gupta and A. K. Sarkar**  
Faculty of Management, MJPRU, Bareilly, India

### **ABSTRACT**

Higher Disposable income and greater health awareness have resulted in an increased domestic demand for organic food. Organic foods products are grown and produced by preventing any type of environmental pollution or harmful conditions. However, it is the increasing concern over health aspects and food safety which is increasing the demand for organic food products. Normal food products are restricted with respect to nutritional status, quality or cleanliness but organic food products are perceived by the consumers to be fresh, chemical-free, nutritious, natural, and produced in an environmentally-sustainable manner. It is the rising consciousness for health, fitness and health benefits of organic foods that are influencing the consumer behaviour for purchase of these food products. Therefore, this paper reviews the effect of health consciousness and food safety concern as the driving factors over the buying behaviour of consumers purchasing organic food products. Based on the review, it was identified that there are various factors influencing consumer purchase decision for organic food products. The studies also indicated that consumers are currently health conscious and show their preference for food safety aspects while purchasing organic food products. However, the review of prior studies has also highlighted the research gap. The findings suggest that it is essential to understand the level of influence of health consciousness and food safety on the consumer buying behaviour for organic food products through further research.

Keywords: Organic food products, Consumer buying behaviour, Health consciousness, Food safety, Organic farming, agriculture, health awareness, sustainability

### **1. INTRODUCTION**

Agriculture is considered to play an important role in the progression of economic development specifically in less developed nations such as India (Cervantes-Godoy & Dewbre, 2010; Arjun, 2013). For India, agriculture has been the main source of national income and occupation at the time of Independence as 72% of the population were occupied in agriculture (Golait, 2007). To accomplish the goal of self-sufficiency in agriculture, a new agricultural strategy was initiated in 1966-67 also known as New Agricultural Strategy or Green Revolution (Evenson & Gollin, 2003). Majority of the success of this first Green Revolution was caused by combining high rates of investment in crop research, infrastructure, and market development and appropriate policy support. The Green Revolution strategy for food crop productivity growth was mainly dependent on the fact that if appropriate institutional mechanisms are provided, technology spill overs across political and agro climatic boundaries could be captured (Pingali, 2012). With efforts made for this strategy, success was achieved for crop production in agriculture by increasing production by use of harmful pesticides and fertilizer. The programmes that were included in the new strategy were the high yielding varieties programme, multiple cropping programme, integrated development of dry areas, plant protection measures, increased use of fertilizers, and new irrigation concept (Lynch, 2007). The Green revolution had positive as well as negative effects (Roy et al., 2007). For India, positive effects were observed with the fact that from once being dependent on import of food grains for satisfying the needs of its population, the country gradually became an exporter of food grains (Bantilan, 2005). However, the negative impacts of the Green revolution included loss of biodiversity, gas emissions, dependence on non-renewable resources, land degradation, severe impact on health, and excessive use of pesticides leading to ailments and cancer (Kumar, 2007).

Food fulfilment or sufficiency is among the most basic human rights and the determinant factor in national security. Even though the Green revolution contributed significantly toward food sufficiency, it developed severe other problems related to the environment and health (Kishi, 2012). Therefore, the organic farming system, termed to be eco-friendly agriculture, was anticipated to be the most suitable solution in limiting or even removing the negative effects of conventional farming (Hazell, 2009). As organic farming has the capability to take care of various problems generated as outcomes of the Green revolution, the shifting towards organic food and farming started again (Chandrashekar, 2010). The environmental concerns faced by humanity are associated with unsustainable consumption patterns and lifestyles (Goudie, 2018; Hoekstra & Wiedmann, 2014; Woods, 2010). In this context, sustainability is defined as that consumption pattern which enables meeting the requirements of current generations with no compromise on the requirements of future generations

(Thiele, 2016; Caradonna, 2014). This concept is linked with the basic requirements such as food as the current food chain is majorly dependent on food scarcity, application of pesticides, and industrialized set-up of the agricultural system. The rising consumer demand for organic food can be observed to be based on most of these facts (Hamzaoui-Essoussi & Zahaf, 2012).

Due to the rise in demand for organic food and establishment of an organic food market, there is an immense premium in selling organic products in the export markets as well as to substantial, health conscious national consumers (Sahota, 2009; Dimitri & Dettmann, 2012). Considering the demand side of organic food markets, there are many factors that influence consumer choices (Manaloor et al., 2016). The rising awareness of the health-fitness and health benefits linked with organic foods are powering the demand for these products across the world (Ashaolu & Ashaolu, 2020; Szalonka et al., 2016). The consumers of organic food products are food phobic's, humanists and welfare enthusiasts, environmentalists, hedonists, and healthy eaters. Therefore, it is vital to have an apparent understanding of the factors that drive the consumers' willingness to consume organic foods (Eyinade et al., 2021; Basha et al., 2015). This awareness and perception for organic foods among consumers is in response to various factors including concern for the environment, food safety, animal welfare, as well as human health (Barański et al., 2017; Rizzo et al., 2020). Therefore, there is a need to understand the consumer buying behaviour for organic food products with specific impact of factors related to health and food safety. In consideration to the above mentioned aspects related to organic food products, this paper is aimed at reviewing the significant effect of factors such as health consciousness and food safety on consumer behaviour in purchasing organic foods in the present settings and from the perspective of future opportunities.

## **2. LITERATURE REVIEW**

### **2.1 Overview of Organic Food Products Market**

The processes followed for conventional agricultural practices have existed since decades and have contributed to the soil and water pollution. The misapplication or overutilization of pesticides and many other synthetic chemical substances are damaging the environment as well as the biodiversity and most importantly human health (Popović et al., 2016). Producing food through organic agriculture not only preserves the natural environment but it also sustains the economic growth, contributes in the optimal utilization of resources, development of rural regions as well as villages, supports sustainable exports and enhances the living standards. The organic food products market and its demand are continuously increasing, and its production in various regions is increasing daily (Golijan & Dimitrijević, 2018). Organic products are described as those organic foods or products of cultivation which prevent the application of artificial and harmful agriculture enhancers such as fertilizers or pesticides and insecticides (Chattopadhyay & Khanzode, 2019). Also termed as green foods, organic food products are produced based on the principle of sustainable development, fine quality, nutrition, health and safety (Khan et al., 2015). With the emergence of organic food products, formation and configuration of a new market is being witnessed which is further leading to development of the organic food market supported by favourable economic, social and technological factors. Therefore, the organic food market is defined as that economic entity which develops a suitable environment for the sale (wholesale sale) of agricultural products comprising food products, within particularly equipped and appointed places in conformity with the law (Bazaluk et al., 2020).

In the current scenario, the organic food market has been developing gradually with 25-30% that reflects the massive prospective demand of organic products. In context to India, the organic food sector has observed amazing growth in the past few years (Manaloor et al., 2016). Organic food production is considered as a vital approach to attain transformations towards higher sustainability within the food sector (Hansmann et al., 2020). Moreover, organic food products are also viewed to be greatly related to improvements in food quality and health. Therefore, the demand for organic products is crucial for transforming agricultural production in more ecological and sustainable directions (Aryal et al., 2009). The development of organic food product markets is enabled by the two categories of factors namely affecting producers and affecting consumers. Moreover, the development of the organic food products is driven by the regulatory system development, the guarantee system including organic farming standard, certification, certification body, producer certification, producer inspection, and labelling of the finished products (Nechaev et al., 2018).

According to Dias et al. (2020), in addition to the environmental aspects related to organic products, new values of organic food products also comprise participative procedures, alternative markets, certification as well as the food traceability and all of these are aspects associated with hygiene and dietary reeducation. The conversion of these values, when implemented to business strategies within the scope of agriculture which is working with organic production, indicates significant relations currently in the process of constructing new markets.

Therefore, the food quality, or the new values characterized by it, is dependent on the institutionalization of social and environmental concerns and emerges as important elements to understand the market and consumption. Brantsæter et al. (2017) specified that even though organic products have a minor share in the world food market, the rise in certified commodities and their availability in mainstream supermarkets have made organic food among the fastest growing segment of the food industry.

The organic food market facilitates the production of safe, controlled certified and high-quality food products simultaneously entailing a high economic and environmental profit thus resulting in the preservation of a healthy environment. Consumer interests in food products of organic origin have been widespread over the last two decades. Countries across the globe have recorded a trend of continual growth in the organic food and beverage market and food products such as fruits, vegetables, bread, cereals, drinks, milk and meat have the biggest share in the organic food market. In terms of international trade, fresh fruits take the first position and although the production and sale of organic food products is highly concentrated in developed economies, less developed countries are also gradually becoming significant producers and exporters of these products (Golijan & Dimitrijevic, 2018).

## **2.2 Benefits of Organic Foods and its Consumption**

Chattopadhyay & Khanzode (2019) explained that organic foods are linked with benefits that aim towards a healthy atmosphere or environment along with improvement in public health conditions. Production of organic foods assists in restoring food quality and food safety with reduced agricultural costs. The further benefits of organic foods and its consumption includes securing better health, reduced exposure to antibiotics injected to Livestock through consumption of meat, eggs or milk, better taste, availability of fresh products, and guilt free products. Ashaolu & Ashaolu (2020) stated that the core benefits related to organic foods development is food quality improvement, promotion of consumers' health, and ecological environment protection for sustainable development. Being attributed to be as safe, nutritive, pollution-free and of high quality, organic foods are advantageous due to safe and healthy consumption, limited application of less chemicals, and rich in higher vitamin and mineral contents as compared to conventional foods. It was further affirmed that organic foods are low-calorie foods and therefore, healthy with higher levels of antioxidants and less harmful chemicals. McCarthy (2015) agreed that benefits related to organic foods include safety, freshness, seasoned sourcing, reputable production lines, competitive pricing, usage of humanely treated livestock, good tastes, self, and family future health.

Organic foods are attributed with high nutritional value and pose advantages for human health. The health benefits of organic food and environmental benefits of organic food production possess advantages over conventional foods (Gopalakrishnan, 2019). Gopalakrishnan (2019) also agreed that organic foods taste better, are safe, avoids pesticide contamination preserve the immune system, have antibiotic resistance, greater antioxidants value, higher standard quality, and assists in environmental sustainability. In consideration of the health benefits, organic food consumption has been decisively exhibited to expose consumers to limited amounts of pesticides related to human disease. Organic farming has been displayed to have reduced environmental effect in comparison to conventional approaches. (Forman & Silverstein, 2012). Among the presented advantages of organic food production in market are environmental appeal with significant improvement, vanishing of pesticides, reduction in pollution, and diminishing impact of global warming (Dias et al., 2020). Brantsæter et al. (2017) specified that claimed health benefits of consuming organic food include limited exposure to contaminants or higher nutritional value. Consumers perceive and value the lower risk of exposure to contaminants regarding organic food products and consider it more important in comparison to higher content of nutrients.

The nutritional content of organic food products address the potential health concerns and offer benefits through consumption. Among the nutrition content, antioxidant activity is the common primary outcome relevant to human health with respect to organic food products and many health benefits have been attributed to antioxidants after consumption (Dangour et al., 2010). Popa et al. (2019) also agreed that the total amount of nutrients accessible to growing plants is comparatively lower but the nutritional value of organic crops is little higher compared to conventional crops. The health benefits related to organic food products comprises higher levels of health-benefiting phytonutrients and few vitamins and minerals with lower levels of insecticide residues.

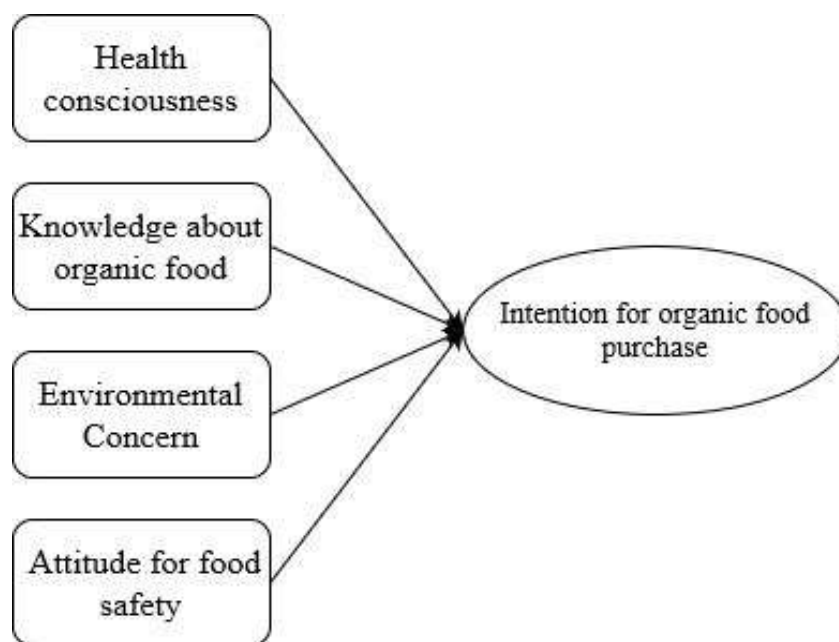
From a different perspective, organic farming provides developing nations with a wide range of social, cultural, environmental and economic benefits. The effect of these benefits can be observed within the global markets that have certified organic products and are increasing rapidly. The process of producing organic food products

and quality lays the foundation for the further health benefits to humans (Eyinade et al., 2021). The expected health and environmental benefits support the consumption of organic food products and therefore assists the purchase of organic food products. The benefits of organic food products are observed to be availed by consumers based on their increased awareness, perception for prices and food labels, and motives for healthy food products (Varma, 2016). Rodriguez (2011) also agreed that the benefits of organic food products and their consumption are based on the personal system of consumers in making food choices which is further based on concern for health, ethical moral, political or religious motives, the quality and safety or safety of conventional foods, environmental considerations, and personal values. Therefore, the consumer benefits are the most significant aspects in identifying the consumer behaviour for organic food products and the success of organic food in the market. According to Das et al. (2020), the in-direct benefits of producing organic food for consumption is related to sustainable development of the environment for humans with better natural landscape and agro-ecosystem, prevention of overexploitation and pollution of natural resources, better natural ecosystem, safe and secure environment, economic balance in a community, better agricultural development, and positive impact on environmental and socioeconomic status.

### 2.3 Factors Influencing the Consumer Buying Behaviour for Organic Food Products

Rising health consciousness along with increasing disposable income and emergence of organized retail has driven the growth of the organic foods market in India at around 19% during 2012-2017. The market for organic foods in India is growing at an compounded annual growth rate (CAGR) of 20-22% (Dangi et al., 2020).

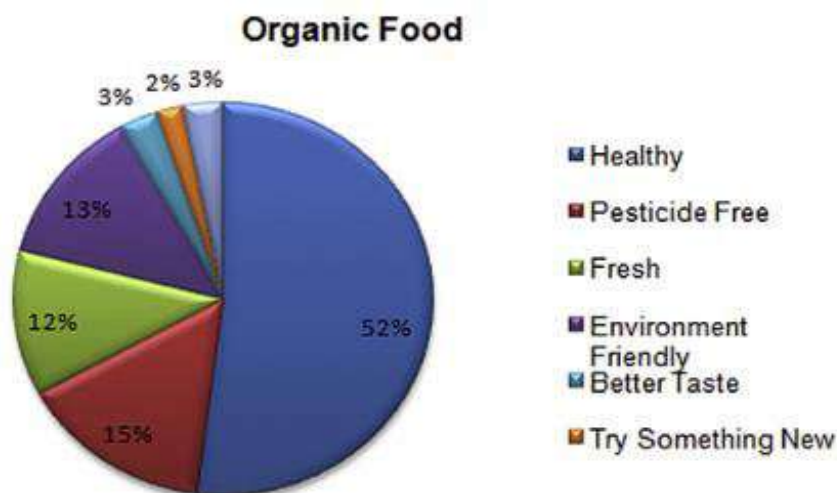
Subha & Lavanya (2017) performed a study to determine the factors including consumer behaviour for organic foods and found that health consciousness, knowledge about organic food, environmental Concern, and attitude for food safety were among the significant factors. Figure 1. Represents the framework of the factors.



**Figure 1.** Factors that influence purchase decision of organic food consumer  
(Source: Subha & Lavanya 2017)

According to Chattopadhyay & Khanzode (2019) in recent years the consumer behavior with respect to factors affecting their consumption pattern of organic food products, have experienced myriad changes as individuals have become more aware of the changes in the factors like climate, pollution, the deteriorating air quality, excessive use of chemicals in the farms, rise in carbon particles in the environment and their impact on the population. Laheri & Arya (2015), stated that awareness is one of the major factors that influence the buying behavior of consumers towards organic food products and therefore the organization of awareness programs by the government, marketers, and environmental agencies to educate consumers regarding the use of eco-friendly products that are good for health and simultaneously safe for the environment, is mandatory.

According to the results gathered from various studies, Singh & Verma (2017), suggested that the four factors such as health consciousness, knowledge, subjective norms, and price have a huge influence on the consumers' attitude and preference towards organic food products. Based on the study performed, reasons for organic food purchasing are presented in Figure 2.



**Figure 2:** Reasons for organic food purchasing (*Source:* Singh & Verma (2017))

Nechaev et al. (2018) also explained that the factors which determine the growth of consumer demand for organic food includes health status, healthy lifestyle, environmental care, awareness, income level and state support of consumers, nutrition, physical and economic availability of goods, and the development of market infrastructure.

However, in addition to these, buying behaviour is also majorly affected by the availability of these products. The easy availability of organic food products positively affects the purchase intention of consumers as they prefer such products that are easily available. Further demographic factors such as age, education, and income also have an influence on the actual buying behaviour of consumers (Jayanthi, 2015).

Krishna & Balasubramanian (2018), in their study, incorporated factors such as consumers' willingness to pay, certifications, and labelling concerning organic food products and their quality and safety, as some of the significant factors influencing the purchase intention of consumers towards organic food products. The data from the study revealed that consumers' concern for health, environment, and the need for quality food products are the main factors that fostered them to pay an additional premium while making their purchase. Therefore the higher an individual's perseverance towards the worth of purchasing organic products, the higher will be their willingness to pay for them. Further, factors such as awareness with respect to various certifications and labels, advertisements, processing, etc concerning organic food products also play a vital role in consumers' knowledge enhancement. Certification and labelling are two important factors that inspire consumers to buy organic products. Apart from that, the quality and safety of organic food products are consistently encouraged by the governments, healthcare industry experts, etc, as the physical appearance of an organic product is associated with its inner quality.

Familiarity is also an important factor while buying organic food products especially due to the fact that consumers usually do not have any prior expertise or understanding of the products. Low familiarity with regard to the uses of the product, the nutritional value derived from it, the quality it possesses, its taste and environmental benefits, as well as social concerns, are a few of the critical factors which decide the consumption patterns for the organic food products. Basha et al., (2015) recognized that, despite having a positive outlook over such products, dearth of familiarity is a key determinant for the fall in the purchase rate of such organic foods, therefore determination of how far the consumers are exposed to media in order to gather information regarding these organic food products with respect to their quality, safety, and environmental benefits is indispensable.

Teng & Wang (2015) claimed that in many countries consumers consider the purchase and consumption of organic food products as an indicator of their living standards or status symbol. Hence, consumers' purchase of such products turns out to be a sign of luxury and is one of the most common trends among the elite class of consumers in society. It signifies the increased purchasing power and luxurious lifestyle of consumers as a result of greater disposable income. Matic & Puh (2016) proposed that consumers with higher disposable income prefer the consumption of organic food products mainly due to the intention of showcasing their level of awareness, attitude as well as a status symbol. Another major factor that stimulates consumer awareness is brand recognition as there are certain specific brands that are chosen by consumers due to their higher quality and hence such considerations influence their buying behaviour.

#### **2.4 Health Consciousness and Effect on Consumer Buying Behaviour for Organic Food Products**

Health consciousness refers to the readiness of a consumer to undertake health-related actions. With respect to the organic food market, health-conscious consumers tend to be more aware and concerned about their wellness and are inclined towards improving and maintaining their health, standard, and quality of living in order to prevent ill health by indulging in healthy behaviours and being self-conscious with regard to health (Akhondan & Carroll, 2015). Nutrition and physical fitness are the two concerns of health-conscious individuals. Studies on the determinants of buying behaviour of consumers towards organic food products have identified health consciousness as a primary motive for the purchase of these products. In addition to that, health consciousness helps in predicting the attitudes, preferences, and purchase intentions of consumers towards these products (Rana & Paul, 2017).

Brantsæter et al. (2017) argued that the health factor associated with organic food products is the reason why there is a growing interest in organic food products worldwide. According to the study, health consciousness is the driving force behind consumers buying behaviour as the health benefits associated with organic food products include reduced exposure to chemical contaminants and increased exposure to nutritional value. Consumers tend to prefer the lower risk of exposure to contaminants as more important than higher content of nutrients. Pacho (2020) in his study also suggested that the behaviour compelling the consumers' intention to buy organic food products depends upon a number of factors; however, findings revealed that health consciousness is one of the most important factors that have an impact on the purchase decisions of the consumers. Health consciousness has an indirect effect on the relationship between other factors such as attitude, subjective norms, and the intention to buy. Several such factors contribute to consumers' motivation to purchase organic foods but most studies conclude that health-conscious consumers show the highest preference for organic food products over other conventionally grown food products. In fact, health consciousness has been considered to be the best indicator of consumer attitude and behaviour towards such food products (Katzeff et al., 2020).

A healthy diet and lifestyle are becoming increasingly important for the consumers parallel with economic growth as this process makes consumers more inclined towards organic food products thus being favourable for the development of the organic food industry. The analyses of the major factors that influence the purchase behaviour of consumers towards organic food products revealed that health issues represent the main reasons for buying organic food and the health factors have become as important as the psychological ones while consumers make decisions with respect to food products (Percsi & Fogarassy, 2019). Rana & Paul (2017) also followed the same direction of analysis and found that health-conscious consumers show an increasing preference for organic food over other conventionally grown food products. This major shift in the attitude of modern consumers is mostly influenced by the rising incidence of lifestyle diseases, such as heart ailments and depression. It has occurred due to the fact that organic food has fulfilled modern consumers' expectations with regard to food products. All this has led even the retailers and marketers to promote their products as being healthy which differ from the promotional efforts related to conventional hedonic food items. They also argued that successful adaptation to such industry practices that promote a healthy shift in the consumption habits of individuals will further help businesses produce healthy food products to thrive.

According to Shin & Mattila (2019) in response to the rising demand for organic food products several restaurants have begun to add options for healthy food items into their menus. In order to highlight the impact of organic food choices in the context of a restaurant, the scholars examined the joint effect of gender and health consciousness on other food choices that is both healthy and unhealthy and found that males and females with low levels of health consciousness are more likely to select unhealthy food options whereas those with higher levels of health consciousness are more likely to choose healthy food options. Consumption patterns around the world indicate consumers' increasing interest in the purchase of organic food due to the growing consciousness of personal health among consumers. Scholars have attributed this growing interest in organic food products to a number of reasons, the major one being the adverse effects of chemically grown food products on the environment and on consumers' personal health. Organic food is considered to be more eco-friendly, natural, unadulterated, and thus, healthier than food products grown using chemical fertilizers and pesticides (Tandon et al., 2021).

#### **2.5 Food safety and effect on consumer buying behaviour for organic food products**

The rising demand of organic food products is driven by many factors and safety of food is among the main factors that is shaping the rising consumers' consciousness and buying behaviour. It is evident that the determinants of organic food consumption that drives the consumer buying behaviour for organic food products can be majorly positioned as health problems, safety of organic foods and the belief that organic foods

contribute to the ecological system. Organic food is attributed to be safe and healthy for consumption based on its composition, method of production, minimal impact on the environment, and high nutrition, consumers perceive food safety as a vital aspect for buying organic food products. (Krishnakumare & Niranjana, 2017). Customer enthusiasm for organic products can be viewed as proactiveness of consumers to their physical risks of food consumption. The expectation is that the traceability of all stages of the supply chain ensures the organic food safety and has become an important consideration for consumers (Waqas & Hong, 2019). Waqas & Hong (2019) performed a study to understand the effect of selected variables on the consumer buying behaviour for organic foods and the study findings revealed that organic food attitude and safety of food were significant factors for consumer intentions to purchase organic food.

It is fundamental that health attributes play a contributing role in generating consumer preferences for organic food products (Rizzo et al., 2020). A consumer buying organic food products can be profiled as altruistic, hedonically motivated, and concerned about the quality of the products which is freshness and taste, and food safety (Hashem et al., 2018). Besides the health consciousness that significantly influences consumer buying behaviour, food safety along with ecological values (environmentally friendly), taste and quality assurance (label of certificate) are equally significant (Cachero-Martínez, 2020). Li & Xin (2015) performed a study to examine a set of factors that influences the consumption of organic food products and the studying findings confirmed that food safety, nutrition, and environmental friendliness are important factors that affect the purchase of organic food while considering the demographic variables.

Consumers that have overcome the barriers of price related to purchase of organic food products and are ready to spend for the comparative high prices, are more concerned about food quality. They perceived safe food based on quality to be their main aspect for buying organic food products. Food safety with better quality is being considered as a critical aspect for health consciousness consumers (Darsono et al., 2018). Due to the emergence of lifestyle diseases and high incidence of diabetes and heart disorders have raised an alarm that have further made consumers realize the significance of food quality and safety. The demand for organic food products is observed to be higher based on the health and safety spectrum of organic food as the conventional food products are polluted due to the presence of chemical residues, pesticides and toxins. Food safety as a vital factor increases the consumption of organic food products and is actively promoted by governments, healthcare industry professionals, and researchers (Rana & Paul, 2017). Le-Anh & Nguyen-To (2020) performed a study to analyze those factors that affect the consumers' attitude towards organic food and their purchase intention for this type of food products in an emerging market. The study outcomes indicate that awareness of organic food, information on organic food, food safety concern and perceived value of organic food have positive impacts on attitude towards organic food. Therefore, food safety includes adequate information about the food product with offered value. Alshammari (2020) mentioned that due to changing lifestyle and eating habits, consumers are more focused on healthy food products which are accessible through organic food products. Alshammari (2020) performed a study to determine the factors affecting consumers' attitudes and purchase intention toward organic food products. The study findings revealed that issues relating to food quality and scepticism impact the most the consumers' attitudes toward organic food products. Moreover, the study findings even revealed that organic food knowledge and health consciousness are also significant in influencing consumer attitudes toward organic food in Saudi Arabia. Therefore, marketers must consider food safety as an important aspect while designing strategies for organic food products in market as the more favourable the attitude is toward organic food, the more consumers are willing to purchase the products.

### **3. RESEARCH GAP**

Due to the adverse effects of genetically modified organisms, pesticides, and further artificial chemical products utilized in traditional agricultural practices on health and environment, different segments of people are being interested in organic food products. Consumers are considering organic food products to be more environmentally friendly, highly nutritious, and safe as well as healthy. Organic food products tend to be satisfying for people that perceive the benefits of consuming these organic food products due to concerns for health and food safety. Based on the review of previous studies, it is found that there have been a lot of studies that focus on determinants of organic food consumption and factors affecting the consumer buying behaviour for organic food products. The prior studies have identified factors that potentially influence the consumer buying behaviour and organic food consumption which includes consumers' concerns regarding health consciousness, food safety, the environment, animal welfare, and a wholesome lifestyle. However, as the main concerns of consumers are related to health and food safety as a high number of consumers are becoming health conscious, organic food purchase and corresponding consumer buying behaviour appears to be impacted by majorly these two factors. Previous literature studies include very few studies exploring the influential effect of

health consciousness and food safety on the organic food purchase among consumers specifically. This highlights a major research gap, as it is necessary to identify the actual purchase behaviour of consumers based on their health concerns and food safety preferences in existing settings. Since most of the consumers that prefer buying organic food products are concerned for health and food safety, it is essential to understand in detail the effect of these factors specifically on consumers' organic food purchase behaviours. Based on this consumer analysis, it will be easier for marketers to create and formulate successful strategies that influence actual consumer purchase behaviour.

#### 4. CONCLUSION

Due to the rising improvement in people's awareness, organic food products are starting to become mainstream and also have the potential to improve the future health of human populations. The organic food market has undergone an unparalleled growth with time as the consumers buying behaviour for these food products is driven by healthfulness, taste, environment-friendliness, safety, and local agriculture support. A consumer-based approach to understand the organic food products market and consumer behaviour for purchasing these products is useful not only for better understanding of the varying organic market dynamics but also for organic consumer demand and market analysis. The quality attributes of organic food accounts for inputs into a consumer's demand function for improved human health and general well-being. Concern with food safety and health risks has driven various kinds of consumers to search for foods whose qualities and safety attributes are guaranteed. Organic products are perceived by consumers to offer enhanced health value, and to be safer for consumption. As the horizons of consumer's progress beyond basic concerns regarding food availability, and their budgets are allowing for higher discretionary spending, the food safety factor has started gaining importance. Consumers are becoming highly health conscious and are inclined towards consuming healthier and more nutritious food products. They reflect willingness to pay for better health value and food quality, and are ready to spend more time researching the organic food marketplace. It is evident from this review that food safety, human health consciousness, and environmental concerns influence consumer preferences. However, a detailed understanding of the effect of food safety and human health consciousness as main factors impacting consumer buying behaviour is identified as a research gap which needs to be addressed with detailed insights. An empirical study aimed at understanding the linking between organic food products purchased by consumers and health consciousness with food safety as the influencing variables to comprehend better the way consumers really perceive the food quality and safety attributes of organic products along with health benefits in comparison to their conventional counterparts. The focus on the aspects of food safety and health value will also reveal the consumers' behaviour towards organic food products and their place in the food marketplace along with the level of impact that each of these variables contribute to the purchasing decisions of organic foods.

#### REFERENCES

1. Akhondan, H., Johnson-Carroll, K., & Rabolt, N. (2015). Health consciousness and organic food consumption. *Journal of Family & Consumer Sciences*, 107(3), 27-32.
2. Alshammari, E. H. (2020). Factors Influencing Organic Food Purchase Intention in an Emergent Market: An Empirical Investigation of Saudi Arabia. *European Journal of Business and Management Research*, 5(6).
3. Arjun, K. M. (2013). Indian agriculture-status, importance and role in Indian economy. *International Journal of Agriculture and Food Science Technology*, 4(4), 343-346.
4. Aryal, K. P., Chaudhary, P., Pandit, S., & Sharma, G. (2009). Consumers' willingness to pay for organic products: a case from Kathmandu valley. *Journal of Agriculture and Environment*, 10, 15-26.
5. Ashaolu, T. J., & Ashaolu, J. O. (2020). Perspectives on the trends, challenges and benefits of green, smart and organic (GSO) foods. *International Journal of Gastronomy and Food Science*, 100273.
6. Bantilan, M. C. S. (2005). Impact of agricultural research: post-green revolution evidence from India.
7. Barański, M., Rempelos, L., Iversen, P. O., & Leifert, C. (2017). Effects of organic food consumption on human health; the jury is still out!. *Food & nutrition research*, 61(1), 1287333.
8. Basha, M. B., Mason, C., Shamsudin, M. F., Hussain, H. I., & Salem, M. A. (2015). Consumers attitude towards organic food. *Procedia Economics and Finance*, 31, 444-452.
9. Bazaluk, O., Yatsenko, O., Zakharchuk, O., Ovcharenko, A., Khrystenko, O., & Nitsenko, V. (2020). Dynamic Development of the global organic food market and opportunities for Ukraine. *Sustainability*, 12(17), 6963.



10. Brantsæter, A. L., Ydersbond, T. A., Hoppin, J. A., Haugen, M., & Meltzer, H. M. (2017). Organic food in the diet: Exposure and health implications. *Annual review of public health*, 38, 295-313.
11. Brantsæter, A. L., Ydersbond, T. A., Hoppin, J. A., Haugen, M., & Meltzer, H. M. (2017). Organic food in the diet: Exposure and health implications. *Annual review of public health*, 38, 295-313.
12. Cachero-Martínez, S. (2020). Consumer Behaviour towards Organic Products: The Moderating Role of Environmental Concern. *Journal of Risk and Financial Management*, 13(12), 330.
13. Caradonna, J. L. (2014). *Sustainability: A history*. Oxford University Press.
14. Cervantes-Godoy, D., & Dewbre, J. (2010). Economic importance of agriculture for poverty reduction.
15. Chandrashekar, H. M. (2010). Changing scenario of organic farming in India: An overview. *International NGO Journal*, 5(1), 34-39.
16. Chattopadhyay, A., & Khanzode, P. (2019). An Empirical Study on Awareness and Consumption pattern of Organic Food In Bengaluru City, The IT Capital of India: An Analysis with Respect to Different Demographic Factors and Availability of Organic Food Products In Bengaluru. *International Journal of Research-GRANTHAALAYAH*, 7(1), 276-296.
17. Dangi, N., Narula, S. A., & Gupta, S. K. (2020). Influences on purchase intentions of organic food consumers in an emerging economy. *Journal of Asia Business Studies*.
18. Dangour, A. D., Lock, K., Hayter, A., Aikenhead, A., Allen, E., & Uauy, R. (2010). Nutrition-related health effects of organic foods: a systematic review. *The American journal of clinical nutrition*, 92(1), 203-210.
19. Darsono, N., Yahya, A., Muzammil, A., Musnadi, S., Anwar, C., & Irawati, W. (2019, January). Consumer Actual Purchase Behavior for Organic Products in Aceh, Indonesia. In *1st Aceh Global Conference (AGC 2018)* (pp. 265-275). Atlantis Press.
20. Das, S., Chatterjee, A., & Pal, T. K. (2020). Organic farming in India: a vision towards a healthy nation. *Food Quality and Safety*, 4(2), 69-76.
21. Dias, V. D. V., Schultz, G., Schuster, M. D. S., Talamini, E., & Révillion, J. P. (2015). The organic food market: a quantitative and qualitative overview of international publications. *Ambiente & Sociedade*, 18(1), 155-174.
22. Dimitri, C., & Dettmann, R. L. (2012). Organic food consumers: what do we really know about them?. *British Food Journal*.
23. Evenson, R. E., & Gollin, D. (2003). Assessing the impact of the Green Revolution, 1960 to 2000. *science*, 300(5620), 758-762.
24. Eyinade, G. A., Mushunje, A., & Yusuf, S. F. G. (2021). The willingness to consume organic food: A review. *Food and Agricultural Immunology*, 32(1), 78-104.
25. Forman, J., & Silverstein, J. (2012). Organic foods: health and environmental advantages and disadvantages. *Pediatrics*, 130(5), e1406-e1415.
26. Golait, R. (2007). Current issues in agriculture credit in India: An assessment. Reserve Bank of India.
27. Golijan, J., & Dimitrijević, B. (2018). Global organic food market. *Acta Agriculturae Serbica*, 23(46), 125-140.
28. Golijan, J., & Dimitrijević, B. (2018). Global organic food market. *Acta Agriculturae Serbica*, 23(46), 125-140.
29. Gopalakrishnan, R. (2019). Advantages and Nutritional Value of Organic Food on Human Health. *International Journal of trend in Scientific Research and Development*. 3.4: 242, 245.
30. Goudie, A. S. (2018). *Human impact on the natural environment*. John Wiley & Sons.
31. Hamzaoui-Essoussi, L., & Zahaf, M. (2012). The organic food market: Opportunities and challenges. *Organic food and agriculture-new trends and developments in the social sciences*.
32. Hansmann, R., Baur, I., & Binder, C. R. (2020). Increasing organic food consumption: An integrating model of drivers and barriers. *Journal of Cleaner Production*, 275, 123058.

33. Hashem, S., Migliore, G., Schifani, G., Schimmenti, E., & Padel, S. (2018). Motives for buying local, organic food through English box schemes. *British Food Journal*.
34. Hazell, P. B. (2009). The Asian green revolution (Vol. 911). *Intl Food Policy Res Inst*.
35. Hoekstra, A. Y., & Wiedmann, T. O. (2014). Humanity's unsustainable environmental footprint. *Science*, 344(6188), 1114-1117.
36. Jayanthi, M. (2015). Consumers' awareness towards organic food products in Coimbatore District. *Indian Journal of Marketing*, 45(12), 7-23.
37. Katzeff, C., Milestad, R., Zapico, J. L., & Bohné, U. (2020). Encouraging organic food consumption through visualization of personal shopping data. *Sustainability*, 12(9),
38. Khan, M. R. T., Chamhuri, S., & Farah, H. S. (2015). Green food consumption in Malaysia: a review of consumers' buying motives. *International Food Research Journal*, 22(1), 131.
39. Kishi, M. (2012). The health impacts of pesticides: what do we now know?. In *The pesticide detox* (pp. 45-60). Routledge.
40. Krishna, R., & Balasubramanian, P. (2018). The significance of factors influencing consumer behaviour towards organic food products in Kochi. *International Journal of Pure and Applied Mathematics*, 119(12), 2641-2665.
41. Krishnakumare, B., & Niranjana, S. (2017). Consumers' buying behaviour towards organic food products in Tamil Nadu. *Agricultural Economics Research Review*, 30(347-2017-2044), 133-138.
42. Kumar, P. (2007). Green Revolution and its Impact on Environment. *International Journal of Research in Humanities & Soc. Sciences*, 5(3), 54-57.
43. Le-Anh, T., & Nguyen-To, T. (2020). Consumer purchasing behaviour of organic food in an emerging market. *International Journal of Consumer Studies*, 44(6), 563-573.
44. Li, X., & Xin, Y. (2015). Factors influencing organic food purchase of young Chinese consumers.
45. Lynch, J. P. (2007). Roots of the second green revolution. *Australian Journal of Botany*, 55(5), 493-512.
46. Manaloor, V., Srivastava, D., & Islam, S. (2016). Growth of organic food industry in India. *Agrofor*, 1(2).
47. Matic, M., & Puh, B. (2016). Consumers' Purchase Intentions Towards Natural Cosmetics. *Ekonomski vjesnik/Econviews-Review of Contemporary Business, Entrepreneurship and Economic Issues*, 29(1), 53-64.
48. McCarthy, B. L. (2015). Trends in organic and green food consumption in China: Opportunities and challenges for regional Australian exporters. *Journal of Economic & Social Policy*, 17(1), 6-31.
49. Mie, A., & Wivstad, M. (2015). Organic food-food quality and potential health effects.
50. Nechaev, V., Mikhailushkin, P., & Alieva, A. (2018). Trends in demand on the organic food market in the European countries. In *MATEC Web of Conferences* (Vol. 212, p. 07008). EDP Sciences.
51. Pacho, F. (2020), "What influences consumers to purchase organic food in developing countries?", *British Food Journal*, 122(12), 3695-3709.
52. Percsi, K.N., & Fogarassy, C. (2019). Important Influencing and Decision Factors in Organic Food Purchasing in Hungary. MDPI.
53. Pingali, P. L. (2012). Green revolution: impacts, limits, and the path ahead. *Proceedings of the National Academy of Sciences*, 109(31), 12302-12308.
54. Popa, M. E., Mitelut, A. C., Popa, E. E., Stan, A., & Popa, V. I. (2019). Organic foods contribution to nutritional quality and value. *Trends in Food Science & Technology*, 84, 15-18.
55. Popović, A., Golijan, J., Sečanski, M., & Čamdžija, Z. (2017). Current status and future prospects of organic cereal production in the world. *АГРО3НАБЕ*, 18(3), 199-207.
56. Rana, J., & Paul, J. (2017). Consumer behavior and purchase intention for organic food: A review and research agenda. *Journal of Retailing and Consumer Services*, 38, 157-165.

57. Rana, J., & Paul, J. (2020). Health motive and the purchase of organic food: A meta-analytic review. *International Journal of Consumer Studies*, 44(2), 162-171.
58. Rizzo, G., Borrello, M., Dara Guccione, G., Schifani, G., & Cembalo, L. (2020). Organic food consumption: The relevance of the health attribute. *Sustainability*, 12(2), 595.
59. Rodriguez, J. (2011). The role of social identity in organic food purchasing. Retrieved from.
60. Roy, S. S., Mahmood, R., Niyogi, D., Lei, M., Foster, S. A., Hubbard, K. G., ... & Pielke Sr, R. (2007). Impacts of the agricultural Green Revolution-induced land use changes on air temperatures in India. *Journal of Geophysical Research: Atmospheres*, 112(D21).
61. Sahota, A. (2009). The global market for organic food & drink. *The world of organic agriculture. Statistics and emerging trends*, 2009, 59-64.
62. Shin, J., & Mattila, A. S. (2019). When organic food choices shape subsequent food choices: The interplay of gender and health consciousness. *International Journal of Hospitality Management*, 76, 94-101.
63. Singh, A., & Verma, P. (2017). Factors influencing Indian consumers' actual buying behaviour towards organic food products. *Journal of cleaner production*, 167, 473-483.
64. Subha, B., & Lavanya, N. (2017, April). Factors Influencing Consumer Buying Behaviour of Organic Food: A study in Tirunelveli District - IJAR - Indian Journal of Applied Research. Retrieved from [www.worldwidejournals.com](https://www.worldwidejournals.com) website: [https://www.worldwidejournals.com/indian-journal-of-applied-research-\(IJAR\)/fileview/April\\_2017\\_1491813796\\_\\_142.pdf](https://www.worldwidejournals.com/indian-journal-of-applied-research-(IJAR)/fileview/April_2017_1491813796__142.pdf)
65. Szalonka, K., Swiatowy, G., & Witek, L. (2016). Health as a determinant of the development of the organic food market. *Acta Scientiarum Polonorum. Oeconomia*, 15(3).
66. Tandon, A., Jabeen, F., Talwar, S., Sakashita, M., & Dhir, A. (2021). Facilitators and inhibitors of organic food buying behavior. *Food Quality and Preference*, 88, 104077.
67. Teng, C. C., & Wang, Y. M. (2015). Decisional factors driving organic food consumption. *British Food Journal*.
68. Thiele, L. P. (2016). *Sustainability*. John Wiley & Sons.
69. Varma, D. N. (2016). Consumption of organic food and Consumers awareness. *International Journal of Science Technology and Management*, 5(5), 130-135.
70. Vishal Kumar Laheri, Purushottam Kumar Arya. (2015). "A Study in Consumer Decision Towards Purchase of Organic Food Products: A Case Study of Delhi", *Indian Journal of Commerce & Management Studies*, 6(2), 84-87.
71. Waqas, A., & Hong, C. (2019). Study on consumer behaviour and food safety of organic products in Pakistan. In *E3S Web of Conferences* (Vol. 78, p. 02021). EDP Sciences.
72. Woods, K. (2010). *Human rights and environmental sustainability*. Edward Elgar Publishing.

## A Study of Biomedical Raman Spectroscopy in Fiber Optical Probe

Monirul Islam and Agrawal Seema

Department of Chemistry, Faculty of Science, Dr. A. P. J. Abdul Kalam University, Indore, MP, India

### ABSTRACT

In vitro tests can be used to diagnose a wide range of conditions. Recent optical fibre probe in vivo studies were promising, but they were restricted to areas that could be easily accessed, necessitating lengthy collection times. In order to maximise system throughput, we've adopted an optical design method based on the Raman dispersion of tissue samples. It is possible to gather high-quality data in less than a second using this method, which maximises collection efficiency and minimises noise. Raman spectroscopy has been shown to be a useful medical tool through simulations and tests with tissue models and different types of in vitro tissue.

Keywords: Laser Design, Fiber-optic Probes, Raman Spectroscopy, In vitro, Tissue Phenomenon, Post Mortum Breast and Barium Sulfate BaSO<sub>4</sub>

### INTRODUCTION

Despite its widespread use today, fibre optics is a simple and ancient technology. In Paris in the early 1840s, Colladon and Babinet laid the foundation for fibre optics by establishing the principle of light direction through refraction. Transmission of light from one component to another via fibre optics is the primary function of this technology. [1] Optical fibres employ thin strands of glass or plastic to carry radiation from one compartment to another across several hundred feet. A single or a group of these may be used in addition to the lighting of objects. In order for light to be transmitted by total internal reflection, an optical fibre must be coated with a substance that has a lower refractive index (cladding material) than the fibre material (core). The chemical used to construct the fiber is essential in determining how much light it can emit.[2]

A fiber's diameter and the wavelength of light employed determine which kinds of light transmission are possible through total internal reflection. For a given wavelength, monomode and multimode fibres are available. It is possible to use monomode fibres to transmit only one mode of light in a given wavelength range and linearly polarised condition, with a glass core with a uniform refractive index profile. [3] Unlike multimode fibres, which have a larger core diameter and may transmit many hundreds of different light modes with different cross-sectional refractive index profiles, monomode fibres have a Gaussian distal spatial intensity distribution. High intensity starts are easier in multimodal fibres than in monomodal fibres due to higher numerical aperture and larger core size. Modal noise, however, is a drawback for these devices. Each transmitted mode is affected differently by any heat or mechanical irritation to the fibre. [4]

Silicates, fluorides, phosphates, and chalcogenides are all used in the building. First, large-diameter preforms with the required refractive index are developed, which are then pulled to generate a long, thin optical fibre. Three chemical vapour deposition processes are widely used to make the preform: inside, outside, and axial deposition. Optical fibres with large concentrations of doped rare earth ions can benefit from using phosphate glass rather than silica glass, which is commonly used. Fluorophosphate glass is a blend of fluoride glass and phosphate glass that does not have the drawback of modal noise.[5]

### MATERIALS

The 830-nm diode laser light from Process Instruments through the band-pass filter, which makes it look like a beam. It then goes through two cylindrical lenses, c1 and c2, to the Raman probe excitation fiber through gold-coated mirror M. Light from the Raman probe's near-linear array is fed into a collimating f/1.8 spectrograph, where the light is collimated and notch-filtered for dispersion before being focused onto a slit and collimated again for dispersion before being sent back through the spectrograph. Last but not least, a back-lit, liquid-nitrogen cooled CCD detector with a laptop computer is used to collect and process the scattered light. Raman scatterers can be used to figure out how well a filter is working.

#### • Raman Scatterers To Assess Filter Performance

Barium sulphate BaSO<sub>4</sub>, a well-known Raman scatterer, was used to test the effectiveness of the probe filter and collection. There was no coverslip on the sample holder, so the BaSO<sub>4</sub> powder was densely packed. Raman spectra were then acquired for 0.1 seconds with a 100-mW excitation power using the probe in light contact with the material. An unfiltered optical fibre probe can be used to test filter performance because of the highly reflective nature of BaSO<sub>4</sub> packed in the fibre. A phantasm of tissue

• In Vitro

A single-ring Raman probe with an excitation power of 100 mW was used to collect tissue samples in vitro, with collection durations ranging from 1 to 60 seconds. Breast tissue samples were obtained during the procedure. Materials were collected, instantly frozen in liquid nitrogen, and then kept at 85°C until they were analyzed. To passively warm samples to room temperature, phosphate-buffered sodium chloride was employed in this work. The spectral sensitivity of the filters and CCDs was adjusted using a tungsten white-light source. We employed a roughened metal surface as an excitation source to eliminate the remaining fiber background. To remove any leftover tissue fluorescence, a 5th-order polynomial was removed. Finally, we utilized spectroscopic models created in our lab to demonstrate how the Raman probe may be used in the real world.

RESULTS

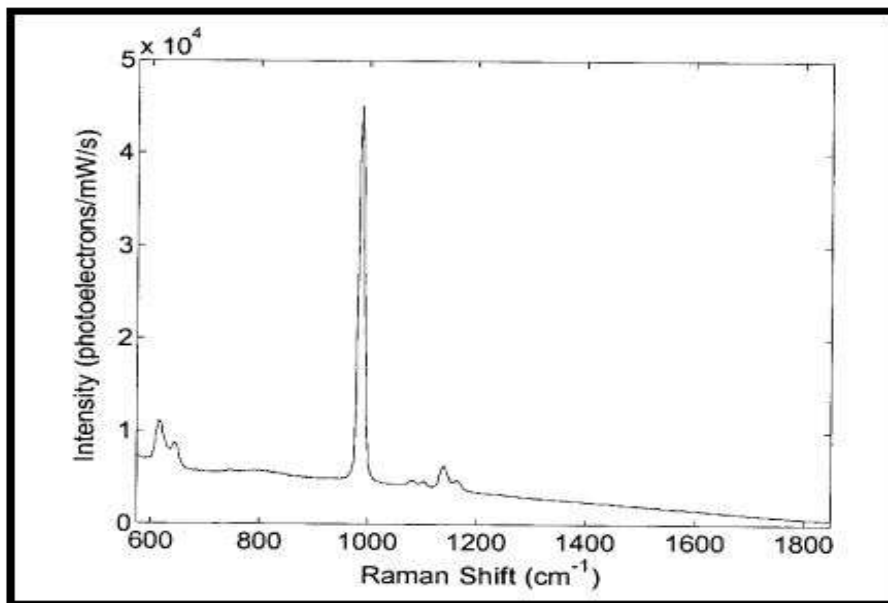


Fig 1. BaSO<sub>4</sub> Raman spectra

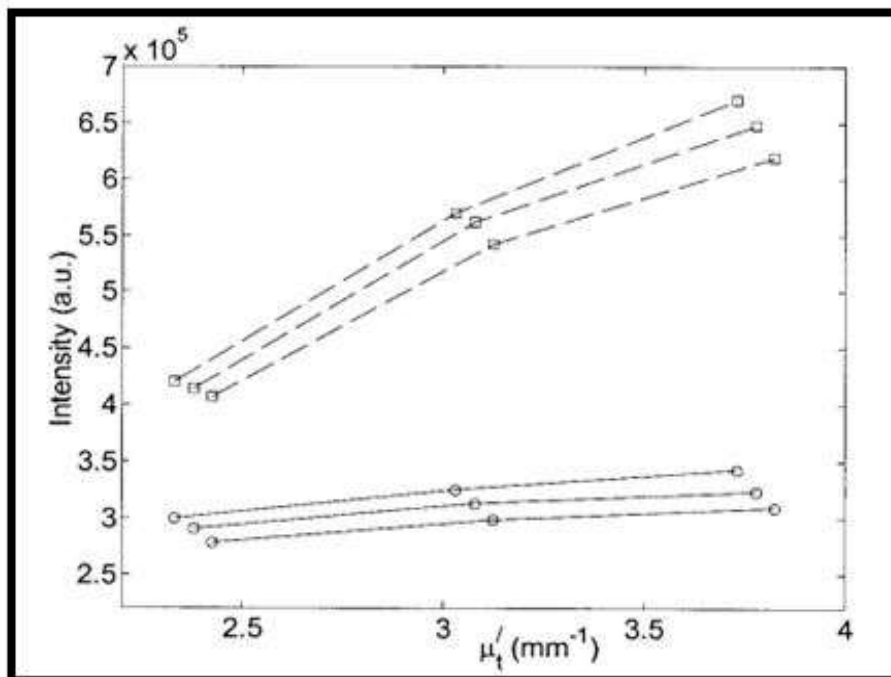


Fig. 2 shows a tissue phantom.

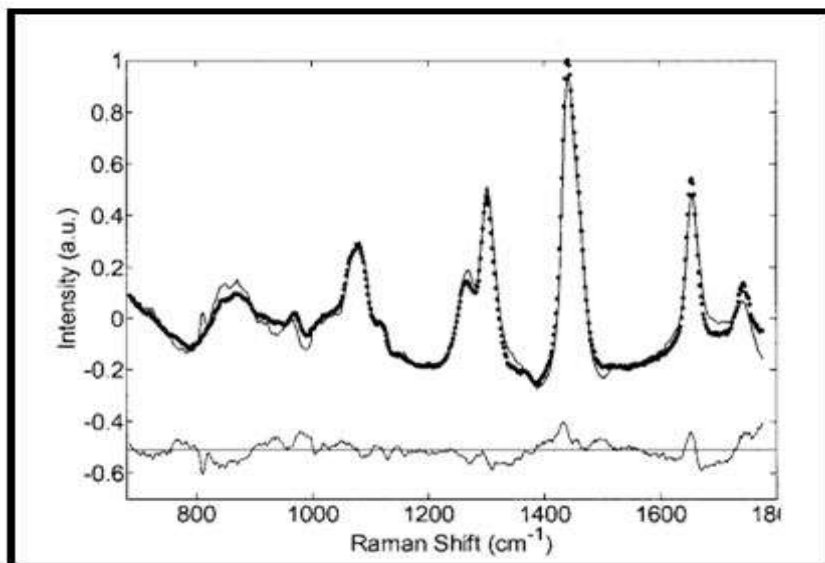


Fig. 3: shows the Raman spectra of normal breast tissue.

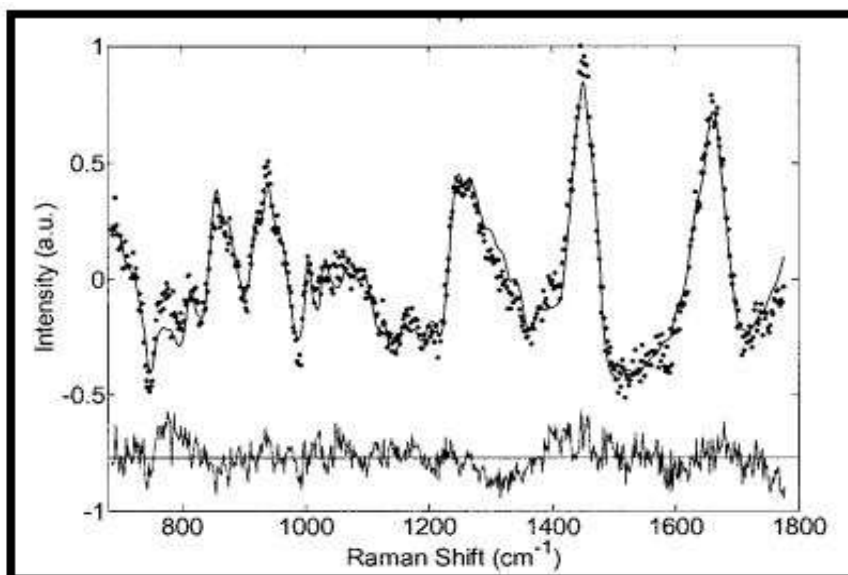


Fig 4. Malignant Raman-specified breast tumour

## DISCUSSION

In biological tissue spectroscopy, only Raman characteristics from 600 to 1800  $\text{cm}^{-1}$  are of interest. Fiber background characteristics over 550 nm are nearly undetectable except for an enhanced sloping backdrop. This shows the efficacy of the filter module and the optical isolation of the probe. Optical tissue phantoms are widely available in a wide variety of forms, geometries, and optical property combinations. As a result of their adaptability, speed, and cost-effectiveness, optical tissue phantoms have become an essential aspect of clinical research. Despite the fact that this Raman probe can be used for a wide range of tissues, it may be preferable to characterise the specific target tissue for other probe designs in order to obtain optimal efficiency. Target tissue can be scanned using optical elements to obtain the appropriate spatial and angular dispersion.

## CONCLUSIONS

A wide range of medical applications need remote sampling using optical fibres, where probe and fiber bundle diameters are constrained by anatomical constraints. This Raman probe was created utilizing a quantitative optical design method and is optimized for use with turbid materials, enabling for spectroscopic analysis of distant tissues. The tip of the probe is equipped with custom-designed in-line filters to reduce the impact of the fibre backdrop. In vitro, breast tissue specimens with varying degrees of disease were analysed and yielded high-quality spectra. Only one second was needed to capture these spectra, proving their clinical usefulness. Future changes to the probe are likely to focus on making it smaller and easier to get to more organs so that Raman spectroscopy can be used in more ways in the clinic.

---

---

## REFERENCES

1. R. Y. Shah "Introduction to fiber optics: Sensors for biomedical applications" *Indian J Pharm Sci*, Vol 73, Issue (1), page 17–22, 2011.
2. B. Mizaikoff, 'Sensory Systems Based on Mid-infrared Transparent Fibers', in "Handbook of Vibrational Spectroscopy", eds J.M. Chalmers and P.R. Griffiths, John Wiley & Sons, Chichester, Vol. 2, Issue (1), page 1560–1573, 2002.
3. Ossowski, M. Sobaszek, et al., "Amperometric sensing of chemical oxygen demand at glassy carbon and silicon electrodes modified with boron-doped diamond, *Sens*". *Actuators B Chem*, vol 189, Issue (1), page 30–36, 2013.
4. H. A. Bruining, A. V. Brusckke, "In vivo determination of the molecular composition of artery wall by intravascular Raman spectroscopy," *Anal. Chem*, vol 72, Issue (1), page 3771–3775, 2000.
5. Itzkan, R. R. Dasari, and M. S. Feld, "Prospects for in vivo Raman spectroscopy," *Phys. Med. Biol.* Vol 45, issue (2), page 1–9, 2000.
6. T. R. Hata, T. A. Scholz, I. V. Ermakov, , "Non-invasive raman spectroscopic detection of carotenoids in human skin," *J. Invest. Dermatol.*, vol 115, issue (3), Page 441–448, 2000
7. C. J. de Lima, S. Sathaiyah, L. Silveira, "Development of catheters with low fiber background signals for Raman spectroscopic diagnosis applications," *Artif. Organs*, vol 24, issue (3), Page 231–234 ,2000.
8. M. G. Shim, "In vivo near-infrared Raman spectroscopy: demonstration of feasibility during clinical gastrointestinal endoscopy," *Photochem. Photobiol*, Vol 72, issue (1), page 146–150, 2000.
9. E. B. Hanlon, R. Manoharan, T.-W. Koo, "Prospects for in vivo Raman spectroscopy," *Phys. Med. Biol*, vol 45, Issue (1), page 1–59, 2000.
10. Auner, GW, Koya, SK, Huang, C, et al. "Applications of Raman spectroscopy in cancer diagnosis". *Cancer Metastasis Rev*, vol 37, Issue (1), page 691-717, 2018.
11. Neugebauer, U, Rosch, P, Popp, J. "Raman spectroscopy towards clinical application: drug monitoring and pathogen identification". *Int J Antimicrob Agents*. 2015, vol 46, Issue (1), page 35-39, 2015.
12. Kourkoumelis, N, Gaitanis, G, "Nail Raman spectroscopy: a promising method for the diagnosis of onychomycosis. An ex vivo pilot study". *Med Mycol*, Vol 56, Issue (1), page 551-558, 2018.
13. Muro, CK, Doty, KC,. "Forensic body fluid identification and differentiation by Raman spectroscopy". *Forensic Chem*, Vol 1, Issue (1), page 31-38, 2016.
14. Skontorp, "Strength and failure mechanisms of polyimide-coated optical fibers, *Proc.-SPIE Int. Soc*". *Opt. Eng.* , vol 3986 , Issue (1), page 240–251, 2000
15. P.T. Joseph, T. Nyan-Hwa, "Transparent ultrananocrystalline diamond films on quartz substrate, *Diam. Relat*". *Mater*, Vol 17, Issue (1), page 476–480, 2008.
16. M. Smietana, "Effect of high-temperature plasma-deposited nano-overlays on the properties of long-period gratings written with UV and electric arc in non-hydrogenated fibers", *Meas. Sci. Technol*, Vol 24, Issue (1), page 940-16, 2013.
17. W.J. Bock, P. Mikulic, "Temperature sensitivity of silicon nitride nanocoated longperiod gratings working in various surrounding media", *Meas. Sci. Technol*, Vol 22, Issue (1), page 115-203, 2011.
18. X. Liu, M. Yan, L. Zhan, "Controlling of symmetric and asymmetric mode coupling in long-period fiber gratings single-side induced by long-pulse CO2 laser", *Opt. Commun.*, Vol 284, Issue (1), page 1232–1237, 2011.
19. S.A. Catledge, "Low temperature growth of nanostructured diamond on quartz spheres", *J. Phys. Appl. Phys*, Vol 38 , Issue (1), page 141-150, 2000.
20. Vermeiren, W.; Gilson, J.-P. "Impact of zeolites on the petroleum and petrochemical industry". *Top. Catal*, Vol 52, Issue (1), page 1131–1161, 2009.

## New Ligands for Organometallic Catalysts Characteristics and Applications

Sikdar Moumita and Agrawal Seema

Department of Chemistry, Faculty of Science, Dr. A. P. J. Abdul Kalam University, Indore, MP, India

### ABSTRACT

In this archive, the general and basic ideas for naming organometallic mixes of the progress elements are sketched out. With the huge development that this field has encountered inside the most recent forty years and taking into account the way that new classes of mixes with exceptional bonding modes have been found, it has gotten important to define extra nomenclature rules. Besides, the coming of new methods for PC stockpiling and recovery of synthetic data just as lawful and business prerequisites have put an extraordinary accentuation on discovering novel names for each new material arranged. An organometallic compound is characterized as any substance species containing in any event one connection between a carbon particle in a natural atom, particle, or extremist and a metal. By their actual nature, the names of organometallic mixes should along these lines consolidate the guidelines of natural chemistry just as those of coordination chemistry. When all is said in done, in any case, these have a place with two distinctive nomenclature frameworks that have advanced independently. It is the point of this Section to characterize an arrangement of organometallic nomenclature that, while being mainly founded on the added substance arrangement of coordination quite far. Likewise, further guidelines are figured that unambiguously assign the extraordinary bonding methods of organometallic mixes. It ought to be accentuated that the point of nomenclature is bound to the exact portrayal of the structure of a compound just as the network of iotas inside an atom or particle. Nomenclature ought not endeavor to pass on insights concerning the extremity of bonds, examples of reactivity or techniques for blend. The authentic viewpoint on these may change with the approach of better hypothetical models or the increment in synthetic information. This is especially evident in a moderately new field, for example, organometallic chemistry.

Keywords: Organometallic, Nomenclature, bonding, chemistry.

### INTRODUCTION

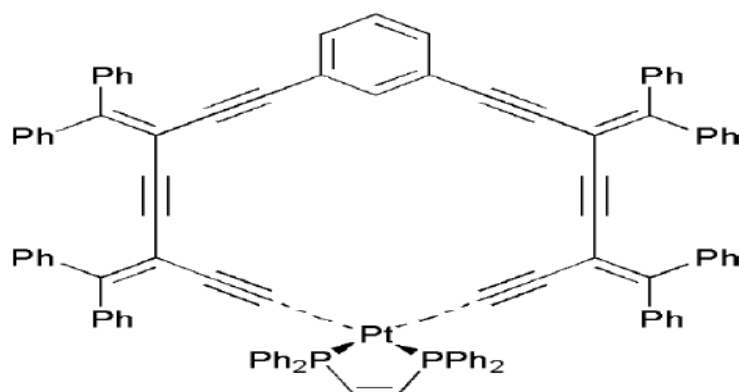
Engineered organic chemistry is worried about the arrangement of novel mixes and improvement of philosophies, especially for the development of C-N, C-C and C-O bonds. Thus the manufactured local area is endeavoring to expand the quantity of changes accessible and the effectiveness with which these changes can be accomplished. One basic method of expanding viability (either as far as expanding the yields and additionally selectivities, the molecule effectiveness or the energy productivity, for example diminishing temperature) of a response is to utilize catalysis. There are two principle zones in catalysis: homogenous catalysis and heterogeneous catalysis. The focal point of this proposition is the plan of ligands for homogenous catalysis utilizing late-change metals [1].

In homogenous change metal catalysis, the dynamic catalyst is generally a metal complex, which comprises of a metal place encompassed by various ligands subject to the metal and response type. These ligands can go from straightforward atoms, for example, carbon monoxide (CO), ethylenediamine and triphenylphosphine, to more perplexing mixes, for example, calixarenes and RNA. There are various strategies that have been utilized to group ligands from frameworks that only glance at the quantity of coordination locales a ligand has to those dependent on the electronic properties of the ligand. One basic approach to arrange ligands is by the quantity of electrons they give to the metal community, for example X or L-type ligands. L-type ligands are those that give two electrons, while X-type ligands give one electron. In situations where a ligand gives multiple electrons a combination of X and L is utilized for example LX for three electrons and L<sub>2</sub> for four electrons. The metals we are generally intrigued by, Ag, Pd, Ir, Pt, Rh are class B (or delicate) metals and consequently really like to tie to delicate bases, for example S and P; though class A (hard) metals lean toward O and N contributors. Fe, Co, Cu, Ni are viewed as marginal metals. [2] The hardness of a metal additionally relies upon the oxidation condition of the metal, for instance CuI is viewed as delicate, while CuII is viewed as fringe. Change metal edifices act in various manners inside the synergist response: they unite the substrates, initiate the substrates by organizing to the metal and lower the actuation energy of the response between substrates. [3] As a rule the utilization of a homogeneous catalyst in a response gives another pathway, in light of the fact that the reactants associate with the metallic complex. These communications make it feasible for thermodynamically preferred responses, which need long occasions to arrive at balance, to be cultivated in practically no time. Along these lines, homogeneous catalysts can be utilized to integrate exacerbates which can scarcely be gotten by traditional strategies. Albeit heterogeneous catalysts are broadly utilized, especially in oil measures, homogeneous change

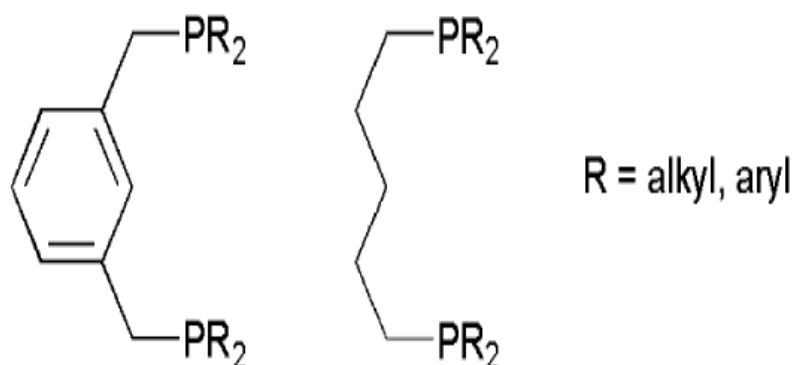


metal catalysts are progressively being applied in mechanical cycles to get fine synthetic substances and polymers. [4-6] A portion of these cycles are: xylene and toluene oxidation to acids, oxidation of hydrosilylation of alkenes ethene to aldehyde, ester buildup to polyesters, carbonylation of methanol and of methyl acetic acid derivation, ring opening metathesis polymerization of dicyclopentadiene and norbornene, polymerization of dienes to unsaturated polymers, unbalanced isomerization, deviated epoxidation, codimerization of 1,3-butadiene and ethene, , rotating copolymerization of ethene and carbon monoxide, and so forth. [7]

The favorable position that enantioselective catalysis has over stoichiometric amalgamation is that one organometallic catalyst particle can create a great many chiral item atoms. Synergist amalgamation likewise creates more modest measures of synthetic waste than stoichiometric organic combination. In this manner the quest for homogeneous enantioselective catalysts that specifically respond to give the ideal item is perhaps the most intriguing patterns with regards to organometallic chemistry. The accomplishment of organometallic catalysts lies in the simple alteration of their current circumstance by ligand trade. [8] An enormous number of various kinds of ligands can arrange to progress metal particles.



Catalytic reactions utilizing very much characterized precatalyst edifices incorporate alkene ring-shutting and opening methathesis utilizing tungsten and molybdenum imido alkylidene precatalysts, chiral organometallic half-sandwich buildings with characterized metal design, rhodium-catalyzed carbon-carbon security framing reactions of organometallic mixes, progresses in utilitarian gathering open minded alkyl-alkyl cross-coupling reactions, deviated catalytic hydrogenation, and ring-opening reactions of oxabicyclic alkenes.[9] The general significance of steric and electronic impacts of chelating diphosphines on catalytic hydroformylation and cyclometalated phosphine-based pincer edifices got from 2 and 3 were audited. An assortment of papers portraying different features of present day homogenous catalysis and organometallic chemistry incorporates the utilization of dispersion and NOE NMR spectroscopy for the investigation of particle associations in arrangement, and picosecond time-settled infrared spectroscopy for the investigation of energized states and reaction intermediates in inorganic frameworks.



## LITERATURE REVIEW

Wolfram A. Herrmann (2002) [10] Organometallic and inorganic coordination chemistry use N-heterocyclic carbenes as universal ligands. In addition to transition metals, they can also attach to main group elements like sulphur, beryllium, and iodine. Due to their unique coordination chemistry, N-heterocyclic carbenes stabilise

and activate metal centres in a variety of critical catalytic steps in organic synthesis, including CH activation and the production of CC, CH, CO, and CN bonds. It's certain that the ligand class of organophosphanes will be complemented, and in some cases, replaced by N-heterocyclic carbenes in the next generation of organometallic catalysts. Scientific competition and surprising breakthroughs in homogeneous catalysis have taken place during the past few years in this chemistry. An organometallic catalysis revolution is arising from research in multiple university and industrial labs.

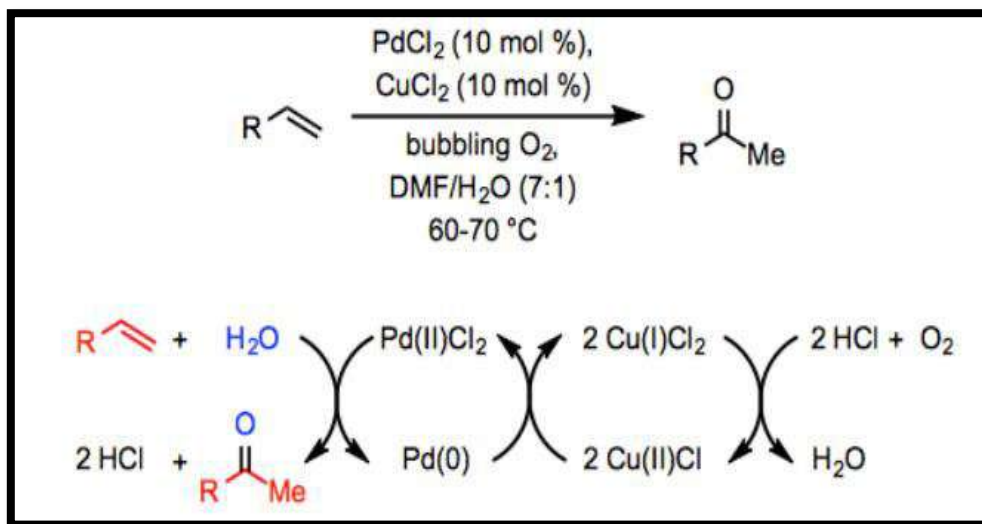
Welin, Eric R. (2017) [11] Organometallic complexes that can cycle through a series of ground-state oxidation states have traditionally been used in transition metal catalysis for fragment-coupling purposes. Direct photoexcitation has been shown to be viable for excited-state organometallic catalysis. Triplet sensitization has long been recognised as a potent activation method in organic photochemistry, but photosensitization mechanisms for excited-state organometallic catalysts have lagged far behind. We use this activation approach to demonstrate excited-state organometallic catalysis: An excited-state nickel complex is formed when energy is transferred from an iridium sensitizer. This complex combines aryl halides with carboxylic acids. The role of photosensitization via energy transfer has been established by extensive mechanistic research.

Smith, Justin D. (2017) [12] Organometallic catalysis traces its ancestry back to the late 18th and early 19th century. While producing amazing chemical transformations was important back then, currently the emphasis is shifting to ensuring long-term viability. Non-aqueous and water-immiscible solvents, modified enzymes, micellar catalysis, catalysis with minimal loading, metal-free catalysis, and catalyst recycling are some of the current promising technologies summarised in this article. Micellar catalysis makes use of environmental metrics, a critical evaluation tool for any industrial chemical process, to demonstrate the process' utility, particularly in terms of streamlining protocols, reducing losses, and eliminating hazardous compounds.

### 3. METHODOLOGY

#### The Wacker Process

Ethylene can be converted to acetaldehyde in an acidic, aqueous solution of PdCl<sub>2</sub> more than a century ago, but it took another 50 years to create a catalytic technique for the reaction. In 1959, PdCl<sub>2</sub> and a stoichiometric quantity of CuCl<sub>2</sub> in an aqueous solution with oxygen bubbling through it were shown to undergo a similar transition [14].

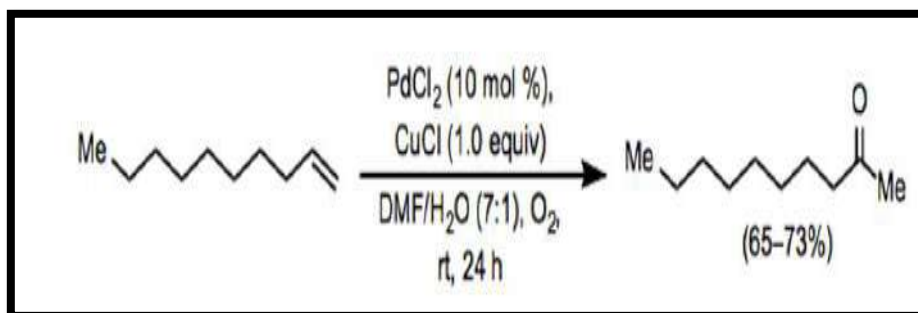


Since that time, the Wacker method has been widely used in organic synthesis and has been expanded to include a wider range of substrates and end products as well. A co-solvent is often used in addition to water to aid in the mixing of organic compounds with the aqueous phase. The "Tsuji-Wacker oxidation" occurs when dimethylformamide (DMF) is employed as a co-solvent with stoichiometric amounts of CuCl under balloon pressure of oxygen. In chemical synthesis, the Wacker oxidation is commonly used to install a methyl ketone molecule, which can then be nucleophilically added to or deprotonated to generate an enolate.

#### Procedure

Flasks of 100 mL, three-necked, round-bottomed capacity were equipped with a magnetic stirring bar and an equalising dropper for the 1-decene (4.2 g, 30 mmol, 1.0 equiv). An aqueous DMF solution (DMF/H<sub>2</sub>O = 7:1; 24 mL) was added to the flask to charge it with a combination of PdCl<sub>2</sub>, CuCl, and DMF. An oxygen-filled

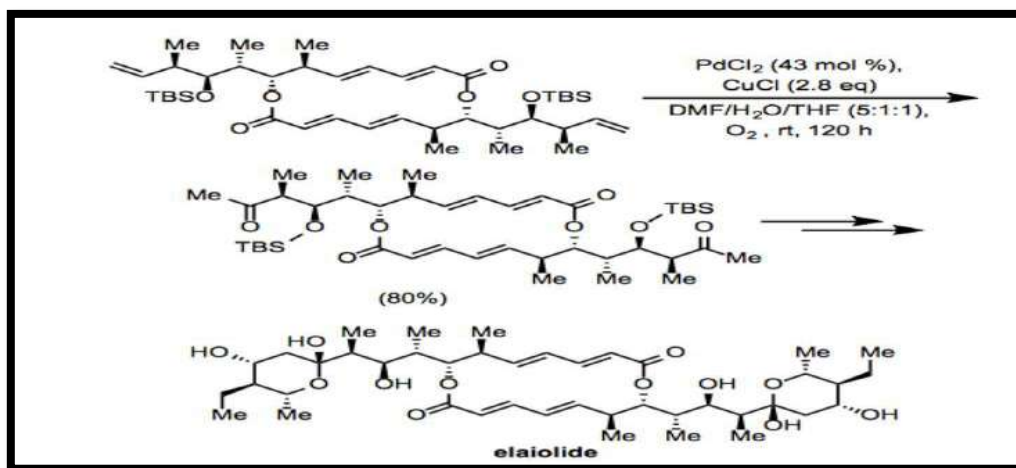
balloon was put over one of the other outlets, and the mixture was agitated at high speed to allow for the uptake of oxygen. Following a period of 1 h, the 1-decene (4.2g, 30 mmol) was added and the solution was agitated rapidly under an oxygen balloon at RT for 10 minutes before the reaction was completed. After 15 minutes, the solution's hue changed from green to black before gradually changing back to green again. Using five 50 mL volumes of ether, the mixture was extracted after 24 hours in cool 3 N HCl (100 mL). All of the extracts were mixed and washed with 50 mL of NaHCO<sub>3</sub> solution, followed by 50 mL of brine, and then dried on anion exchange resin (AER). Two-decanone was obtained as a colourless oil (3.0–3.4 grammes, 65–73 percent) by evaporation of the solvent and distillation of the residue in a 15-cm Vigreux column. IR (neat): 1722 cm<sup>-1</sup> (m, 15H), NMR (1H): 2.37 (2H, J = 7 Hz), 2.02 (3H), 0.7–1.8 (t, J = 7 Hz).



### Applications

It is widely employed in organic synthesis because of the Wacker method's versatility. The terminal alkenes can be installed in a variety of ways, and the methyl ketone products of the reaction can be easily transformed into more complicated substances. Aerobicity and simplicity of operation are two additional advantages of this reaction [15].

The macrolide elaiolide was synthesised via Wacker oxidation. The symmetric natural product was formed after the oxidation of two terminal alkenes in a C<sub>2</sub>-symmetric intermediate. Alkene and ester compounds in the intermediate appeared to have no effect on the rate of the oxidation process.



### CONCLUSIONS

Ligands accept an essential part in the adjustment of the organometallic progress metal edifices. There are a few strategies accessible for the planning of the organometallic change metal edifices. The noticed flimsiness of the organometallic progress metal edifices can be credited to two principle wonders to be specific  $\beta$ -end and bimolecular deterioration reaction that seriously sabotage the precariousness of these buildings. The concealment of these decay pathway in this manner clear route for acquiring profoundly stable organometallic change metal buildings. The gigantic steps made toward the objective of specific catalytic functionalization of C-H bonds by organometallic frameworks. Investigations of stoichiometric reactions have contributed significantly to this advancement; it is essentially through such examinations that we find out about the genuine cycle of C-H actuation. Investigations of catalytic frameworks have driven straightforwardly to improved frameworks; such examinations have likewise clarified the issues looked in the advancement of such frameworks, uncovering numerous issues that are very unmistakable from the test of stoichiometric C-H actuation.[6] Frameworks of critical reasonable utility have just barely started to rise up out of this field.

Extrapolating the current pace of progress, nonetheless, persuades that the following 25 years will see the presence of a different cluster of important frameworks including substrates going from methane to the most intricate focuses of organic blend. Through the molecular design of new catalysts or by utilising basic organometallic chemistry principles in intriguing ways, more active and selective homogeneous catalytic reactions can be achieved, or new catalytic reactions or processes can be discovered.

## REFERENCES

1. El-Newehy, "Reactivity ratios for organotin copolymer systems". *Molecules* Vol 15, Issue (1), Page 2749-2758, 2010
2. Ribeiro, "Adipic acid route: Oxidation of cyclohexene vs. cyclohexane". *Catalysts*, Vol 10, Issue (1), page 1443, 2020.
3. Jahnke, M.C.; Hahn, F.E. "Chemistry of N-heterocyclic carbene ligands". *Top. Organomet. Chem.*, Vol 30, Issue (1), page 95-129, 2010
4. Krawczuk, "A synthesis of the carbon skeleton of maocrystal" *V. Org. Lett.*, Vol 11, Issue (1), page 4774-4776, 2009.
5. Ikegai, K. "Copper(II)-catalyzed O-phenylation of tertiary alcohols with organobismuth(V) reagents". *Chem. Lett.*, Vol 35, Issue (1), page 612-613, 2006.
6. Mukaiyama, T. "Oxidative coupling of carbonyl compounds by using pentavalent biphenyl-2,2'-ylenebismuth reagents". *Chem. Lett.*, Vol 36, Issue (1), Page 718-719, 2007.
7. Patrycja Żak "Application of olefin metathesis in the synthesis of functionalized polyhedral oligomeric silsesquioxanes (POSS) and POSS-containing polymeric materials", *Beilstein J. Org. Chem.*, Vol 15, Issue (1), Page 310-332, 2019.
8. Manoja K. Samantaray "The Comparison between Single Atom Catalysis and Surface Organometallic Catalysis", *Chem. Rev.*, Vol 120, Issue (2), Page 734-813, 2020
9. Manoja K. Samantaray, "Surface organometallic chemistry in heterogeneous catalysis" *Chem. Soc. Rev.*, Vol 47, Issue (1), page 8403-8437, 2018
10. Wolfgang A. Herrmann "N-Heterocyclic Carbenes: A New Concept in Organometallic Catalysis" Vol 16, Issue (4), Page 32-55, 2002
11. Eric R. Welin, "Photosensitized, energy transfer-mediated organometallic catalysis through electronically excited nickel(II)" *SCIENCE* Vol 355, Issue (1), Page 380-385, 2017
12. Justin D. Smith "Organometallic Catalysis and Sustainability: From Origin to Date", *Johnson Matthey Technol. Rev.*, Vol 61, Issue (3), Page 231-245, 2017
13. Rao, M.L.N.; Jadhav, D.N.; Banerjee, D. "A new palladium catalyzed protocol for atom-efficient cross-coupling reactions of triaryl bismuths with aryl halides and triflates". *Tetrahedron* 2008, Vol 64, Issue (1), page 5762-5772, 2008.
14. Jirásko, R.; Císařová, I.; Dostál, L. "Synthesis, structure, and reactivity of intramolecularly coordinated organoantimony and organobismuth sulfides". *Organometallics*, Vol 28, Issue (1), Page 1934-1941, 2009.
15. Jambor, R.; Růžička, A.; Císařová, I.; Jirásko, R.; Holeček, J. "Synthesis and structural study of organoantimony(III) and organobismuth(III) triflates and cations containing O,C,O-pincer type ligands". *Organometallics*, Vol 26, Issue (1), page 2911-2917, 2007.
16. Kliman, L.T.; Morken, J.P. "Allylation of nitrosobenzene with pinacol allylboronates. A regioselective complement to peroxide oxidation". *Org. Lett.*, Vol 12, issue (3), page 3796-3799, 2010.

## **Novel Data Dimensionality Reduction Approach Using Static Threshold, Minimum Projection Error and Minimum Redundancy**

**Satish S. Banait and S. S. Sane**

Department of Computer Engineering, KKWIEER, Nashik, SPPU, Pune, India

### **ABSTRACT**

Dimensionality reduction is an important mechanism to remove redundant and unused attributes from the dataset. Feature selection and feature extraction are key techniques that have been used for dimensionality reduction. A novel hybrid approach named Minimum Projection error Minimum Redundancy (MPeMR) has also been formulated in the literature to improve dimensionality reduction further. In this work, Threshold value is defined to select a combination of features based on Normalized Projection Error (NPe) value. After feature extraction, correlation coefficient and variance techniques are applied for feature subset selection. In this research work we proposed Semi Feature Minimum Projection error Minimum Redundancy (S-MPeMR) algorithm in which feature selection and feature extraction methods are used to generate compound feature set using semi features. For feature extraction MPeMR technique is used, wherein initially semi features are extracted using NPe technique by checking orthogonality among selected original features and combination of features. As against to MPeMR in the proposed S-MPeMR algorithm two novel schemes are used namely, 1) NPe checking based on static threshold value 2) NPe checking based on dataset specific threshold value. In order to validate the proposed algorithm, K-means clustering technique is used to evaluate clustering quality of selected feature subset. Five datasets viz. Ecoli, Abalone, Movement Libras, Yeast, and Waveform Isolate, and Segment are used for performance evaluation. The K-means algorithm is supplied with these five datasets before and after applying Principal Component Analysis (PCA) technique. As compared to the existing MPeMR algorithm, the proposed S-MPeMR algorithm yields high clustering quality.

Keywords: Normalized Projection Error (NPe), Semi Feature Minimum Projection error Minimum Redundancy (S-MPeMR), Dimensionality Reduction, Feature Extraction, Feature Selection, K-means, Principal Component Analysis (PCA).

### **1. INTRODUCTION**

Now a day, datasets with high dimension have been very common in data mining, and machine learning applications. Processing of such a massive data needs huge resources, and computational time [1]. The presence of redundant, irrelevant, and noisy features in such high dimensional datasets, the performance efficacy of the underlying data mining or machine learning algorithm degrades [2]. Hence, it is very crucial to reduce the data dimensionality in order to improve performance efficacy of such algorithms. Additionally, one important benefit of the dimensionality reduction is the possibility of better visualization, noise removal, data compression, and generalization of the underlying data mining or machine learning algorithms [3]-[5]. The dimensionality reduction based approaches can be classified into two categories: feature extraction, and feature selection [2]. These two approaches have been deployed successfully in many real time applications such as text categorization, Image compression, bioinformatics, etc. We know that few features of the given dataset carry very high level of variance as compared to than the rest of the other features of the dataset. It's wise to take into account only such high information carrying features of the given dataset, especially in the context memory and power hungry real time applications. Thus non redundant features are required to be preserved and redundant, unnecessary noisy features are required to be removed from the dataset using a suitable dimensionality reduction technique. Basically the feature extraction technique yields linear or nonlinear combinations of the original features in the given dataset, whereas feature selection technique can provide the most useful features of the given dataset [4]-[6]. The feature selection and extraction techniques are again classified in two sections: supervised and unsupervised based on the nature of dataset. In supervised strategy class labels are used for selecting the feature subset, whereas in unsupervised learning no class label data is provided. Features are selected based on data variance and distribution.

In the last couple of decades, feature selection and feature extraction approaches have been extensively studied [7], [8]. Although the main focus of these two approaches is to improvise the efficiency of the machine learning algorithm and thereby the underlying real time application, all these research works have been conducted independently. From these studies it can be concluded that none of the feature selection techniques provide an optimum combination of features that can be more informative as compared to the original features of the given dataset. As against the feature selection approach, the feature extraction yield transformed features. One more

data dimensionality reduction philosophy that can yield more improved result is to integrate these two approaches in a systematic manner. This novel approach can provide reduced set, and can complement each other. System proposed by Sreevani and C. A. Murthy [9], overcome this drawback and presented a combined approach. In [9], feature selection and feature extraction are two techniques for dimensionality reduction which were studied independently, so that the result contains either original or transformed features. Further the combination of feature selection and feature extraction was used and for this Minimum Projection error Minimum Redundancy (MPeMR) is proposed in literature. In MPeMR, pairing is done for two features. The proposed method is based on two principles: Minimum projection error and minimum redundancy. The proposed algorithm is called as: MPeMR. This technique generates compound feature set from a given dataset. This methodology works for unsupervised dataset. This algorithm tries to provide informative compound feature with minimum projection error. Along with the minimum NPe it tries to reduce redundancy and preserves the orthogonality among feature set. The proposed algorithm works in two stages. In first stage, it uses feature extraction technique and in second stage, it uses feature selection technique. The algorithm follows an iterative process until the desired count of dimension is reached. The important drawback of the work in [9] is that the accuracy of the system is highly dependent on the dataset specific threshold values. As against to [9], the key contributions of this proposed research work are:

- 1) In this research work we proposed Semi Feature Minimum Projection error Minimum Redundancy (S-MPeMR) algorithm in which feature selection and feature extraction methods are used to generate compound feature set using semi features. For feature extraction MPeMR technique is used, wherein initially semi features are extracted using NPe technique by checking orthogonality among selected original features and combination of features.
- 2) As against to MPeMR in [9], the proposed S-MPeMR algorithm two novel schemes are used namely, i) NPe checking based on static threshold value, and ii) NPe checking based on dataset specific threshold value. Minimum NPe value pair is selected for feature extraction.
- 3) In order to validate the proposed S-MPeMR, the K-means clustering technique is used to evaluate clustering quality of selected feature subset. Five datasets Ecoli, Abalone, Movement Libras, Yeast, and Waveform are used for performance evaluation. The K-means algorithm is supplied with these five datasets before and after applying PCA technique. As compared to the existing MPeMR algorithm, the proposed S-MPeMR algorithm yields high clustering quality.

This research manuscript is organized as follows. Section 2 discusses the related recent works in dimensionality reduction techniques followed by the overall system design of proposed dimensionality reduction architecture in the section 3. The section 4 presents the discussion on results, followed by the key research findings and the possible future scope at the end in Section 5.

## **2. RELATED WORK**

In feature selection process, a feature subset is generated by removing redundant features from given dataset. The feature subset includes least number of features that maximizes the classification accuracy in case of supervised learning and better Normalized Mutual Information-NMI, Jaccard coefficient, Jacc and Fowlkes-Mallows index- FM in clustering in case of unsupervised learning. In supervised feature selection technique [1]-[4] important features are extracted by evaluating the correlation of features with respective class labels and prediction performance. Relief algorithm family is discussed [1]. This Relief algorithm is used for feature Selection in binary class attribute feature selection. This algorithm is best for attribute estimation and evaluating the conditional dependencies between attributes. Graph based feature selection technique is proposed in [2]. In this, instead of comparing a selected feature with class labels, it is compared with whole selected feature subset. This technique optimizes the score of entire feature subset. This provides the global optimal solution for feature selection. Minimum Redundancy Maximum Relevance Feature Selection mRMR model is proposed in [4]. This model removes the redundancy occurred during sequential feature selection strategy. This method uses greedy search to select next best suited feature and hence provide the ranking score to the selected features.

In unsupervised learning technique [5]-[7] dataset features are selected using data variance and distribution. A Niching Memetic Algorithm is proposed in [5] to perform feature selection and clustering simultaneously. NMA-CFS(A Niching Memetic Algorithm for simultaneous clustering and feature selection) makes feature selection an integral part of the global clustering search procedure and attempts to overcome the problem of identifying less promising locally optimal solutions in both clustering and feature selection This technique mainly works on chromosomes dataset. The authors in [6] introduced a novel feature selection algorithm called Laplacian Score (LS). Laplacian Score (LS) is used to select the features based on their locality preserving

power. Data variance is calculated using Laplacian Score. This technique uses Laplacian Eigen maps and Locality Preserving Projection. These NMA-CFS [5], Laplacian Score (LS) [6] techniques selects the feature based on the individual feature score and do not calculate the correlation among selected attributes. Due to this, these techniques are unable to produce an optimal feature subset. Multi-Cluster Feature Selection (MCFS) technique is proposed in [7]. This technique selects those attributes which preserves multi-cluster structure of data. To capture the multi-cluster structure of data, this technique uses multiple eigenvectors of graph Laplacian to define affinity matrix of data points. To improve the performance of unsupervised feature selection technique, semi-supervised feature selection is proposed in [8]. In this technique, small amount of labelled data is used as training data to provide additional information. The feature selection techniques are further classified in three categories namely Filter, Wrapper, and Embedded.

Filter method evaluates the usefulness of feature using various techniques such as: mutual information, the point wise mutual information, Pearson product-moment correlation coefficient. The authors in [10] described unsupervised feature selection technique based on maximum information compression index measure. This measure is used to measure feature similarity. Wrapper technique is applied in supervised learning method. This technique selects the features based on given classifier. As per distinct classifier and dataset feature subset selection strategy is evaluated in [11]. In [11] a tailored approach is proposed which can be customized with respect to the classification algorithm and dataset in any domain. These wrapper methods are computationally expensive and time consuming method. But this technique provides high classification accuracy as compared to the filter technique. Embedded Approach is specific learning algorithm and performs feature selection in the training process. It uses model construction process. The model construction is done using LASSO algorithm. This is linear model construction technique. Least Angle Regression (LARS) technique is proposed for model construction [12]. LARS calculates all possible Lasso estimates for a given dataset with less computer time.

Feature extraction technique transforms the high dimensional dataset to non-redundant low dimensional dataset. This technique transforms the D dimensional space to relevant reduced d dimensional space using linear or nonlinear combinations of features. The feature extraction is also classified in supervised and unsupervised categories based on availability of information of class labels. Maximum Margin Criterion (MMC) is the supervised feature extraction technique discussed in [13]. This includes linear as well as nonlinear feature extraction. MMC maximizes the average margin between classes after feature extraction. This technique is also applicable small sized Sample dataset. To work with small sample sized dataset, Angular Liner Discriminant Embedding (ALDE) is proposed in [14]. This is again a supervised learning strategy. This technique calculates the cosine of angles to generate new within-class and between-class scatter matrices. Using these matrices, this technique performs balancing in within class and between-class scatters for feature extraction. PCA is important techniques for linear space transformation in unsupervised feature selection technique [15]. PCA is statistical process. It uses an orthogonal transformation to convert set of attributes to the correlated variables. In PCA each generated variable is combination of all original attributes and hence it is difficult to analyze the results of PCA. Hence, sparse PCA is used is to overcome this problem [16]. This technique evaluates the coefficients using regression-type optimization problem. It uses lasso constraint on the coefficients.

R. O. Duda, P. E. Hart, and D. G. Stork described Independent Component Analysis (ICA) technique in [16]. This is a statistical technique to transform the data linearly to generate components that maximally independent from each other. ICA technique uses estimation of a latent variable model. The study of dimensionality reduction techniques such as feature selection and feature extraction are done independently. If these two techniques applied in symmetric faction, approach may lead to better result generation. Feature set may include both types of feature like individual features and compound features complementary to each other. Sreevani and C. A. Murthy [9] proposed a technique to bridge the gap between these two techniques. This technique provides simultaneous study of feature selection and feature extraction techniques. For supervised feature extraction process Normalized Projection Error -Npe technique is used. It uses pair of features to remove redundancy. In this technique, to remove redundant features, only the combinations of two features are used to club together.

### **3. OVERALL SYSTEM DESIGN OF PROPOSED ARCHITECTURE FOR DIMENSIONALITY REDUCTION**

In proposed work, feature selection and feature extraction methods are used to generate compound feature set using semi features. The Figure 1 shows the architecture of proposed dimensionality reduction methodology. For feature extraction MPeMR technique is proposed. Initially semi features are extracted using Normalized Projection Error-NPe by checking orthogonality among selected original features and combination of features. Threshold value is defined to select a combination of features based on NPe value. After feature extraction,

correlation coefficient and variance techniques are computed for feature subset selection. This is an iterative process to remove unnecessary redundant features.

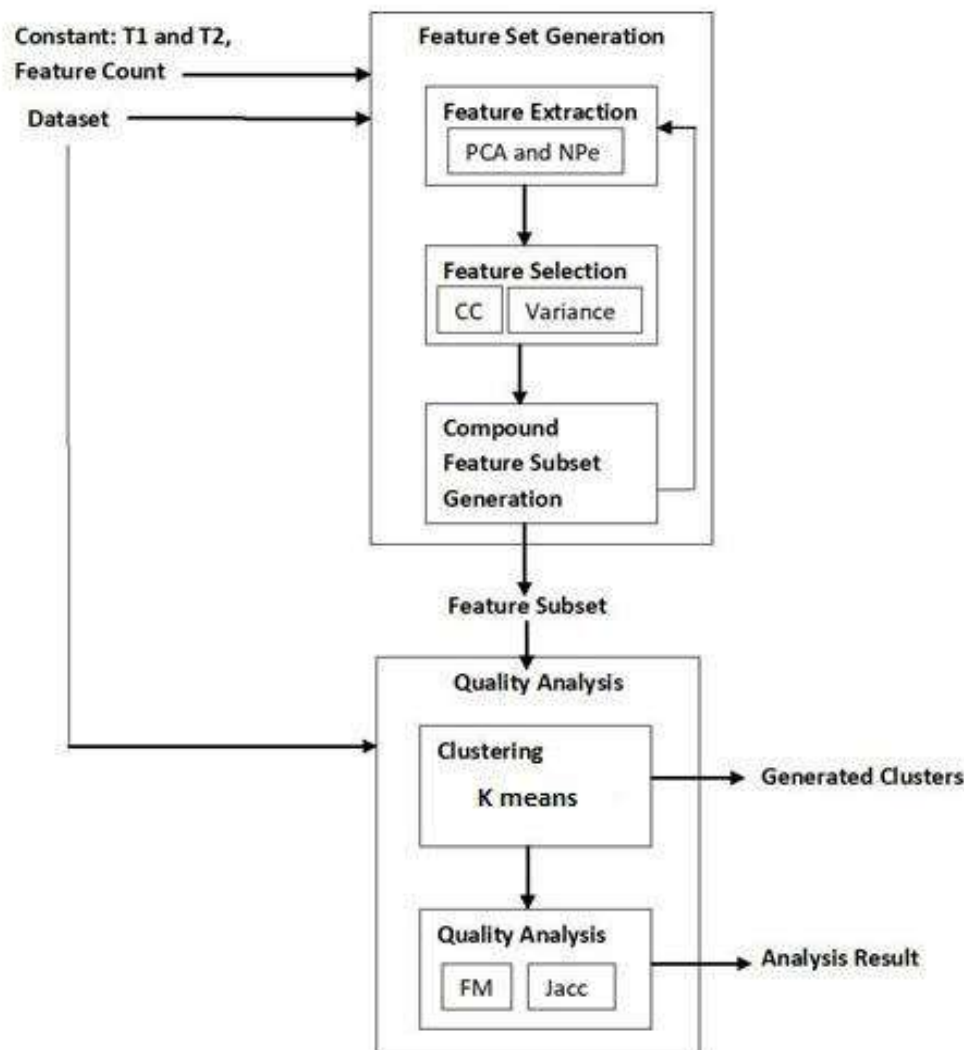


Figure 1: System Architecture of Proposed S-MPeMR

In this proposed work, two techniques are implemented: 1) NPe checking based on static threshold value 2) NPe checking based on dataset specific threshold value. Minimum NPe value pair is selected for feature extraction. Clustering techniques are used to evaluate clustering quality of selected feature subset. Five datasets Ecoli, Abalone, Movement Libras, Yeast, and waveform are used for performance evaluation; with the help of PCA algorithm significant dimensionality is achieved. The coding of the proposed algorithm is implemented using python on Jupyter Notebook and weka-3.2. The proposed algorithm is tested on Core i3 machine with 4GB RAM in windows environment. Table 1 shows the datasets downloaded from UCI repository [17]. These datasets are used for testing of proposed approach.

The proposed system involves two stages namely, Feature Extraction Stage and Feature Selection Stage as shown in Table 2. Unlike [9], instead of using dataset specific threshold values, static threshold values for T1 and T2 are used in the proposed approach. We varied the values of T1 and T2 from 0 to 1 in the steps of 0.1, and noted down clustering accuracy each time. From the statistics generated, it is found that if T1 and T2 values are set to 0.5, then clustering accuracy is highest for our proposed S-MPeMR algorithm. Therefore, we set T1 and T2 to 0.5 while processing all the five datasets. For feature extraction, this methodology uses PCA technique. In PCA technique feature can be merged on the basis of NPe. If NPe is less than the predefined threshold  $T_1$  then eigen values for the set of features is evaluated and features are added in semi feature set. The features used for semi feature generation are then removed from original feature set to preserve orthogonality.



**Table 1:** Datasets used for the Performance Validation of the proposed S-MPeMR algorithm

Sr. No.	Dataset	Instances	Attributes
1	Abalone	4177	8
2	Ecoli	332	8
3	Libras Movement	360	90
4	Yeast	1484	8
5	Waveform	5000	40

The feature selection technique is applied on a Fset. Fset is generated using original features set and semi feature set. To check the redundancy in attributes, correlation coefficient is used. The attributes are correlated if its correlation coefficient is greater than the predefined threshold  $T_2$ . The similar features are identified and redundancy set Rest is generated. To remove attribute form a given Rest, variance technique is used. Variance of each attribute is calculated. The attribute with minimum variance is removed from Fset. After generation of compound feature set, quality of generated feature set is evaluated using clustering technique. The clusters of original dataset as well as updated dataset (containing only selected features) are generated. For clustering K-means and Affinity propagation techniques are used. The clusters generated by original dataset and updated dataset are compared using Jaccard coefficient (Jacc) and Fowlkes-Mallows index (FM).

### Key Terms to Generate Compound Feature Subset Using the Proposed S-Mpemr Algorithm:

In order to generate the compound feature subset using the proposed S-MPeMR algorithm for each of the five datasets considered, computation of following three terms is required. Evaluation parameters are used.

#### 1. Variance

Variance of an attribute is expectation of the squared deviation of attribute values from its mean. It is given by Equation (1).

$$\text{Var} = \sum_i^N \frac{(X_i - \underline{X})^2}{(N-1)} \quad (1)$$

Where  $X_i$  is the attribute value,  $\underline{X}$  is the attribute mean, N is the total no. of values in attribute X.

#### 2. Correlation Coefficient

Correlation Coefficient  $\rho$  is a linear correlation measure between two attributes X and Y is given by Equation (2).

$$\rho = \frac{\sum_i^N (X_i - \underline{X})(Y_i - \underline{Y})}{\sqrt{(\sum_i^N (X_i - \underline{X})^2)(\sum_i^N (Y_i - \underline{Y})^2)}} \quad (2)$$

Where,  $X_i \in X$  and  $Y_i \in Y$  and  $\underline{X}$  and  $\underline{Y}$  are the mean of attribute X and Y respectively. The value of  $\rho$  lies between [-1, 1] if X and Y are completely correlated then the value is -1 or 1. The value is 0 if X and Y are completely independent.

#### 3. Normalised Projection Error(Npe)

The feature extraction process is completed and PCA technique is used for feature extraction. The eigen values and eigen vectors of each attribute pair is calculated. Based on the eigen values, Normalized projection error (NPe) is calculated. If NPe is less than the set static threshold value [9] then these features are merged together using PCA.

From the given subset of feature set  $f_1, f_2, \dots, f_k$  an eigen values are extracted as  $l_1, l_2, \dots, l_k$ . A smallest value  $\lambda_m$  is considered a minimum error introduced while projecting the data. The normalized projection error is the ratio of minimum error  $\lambda_m$  to the summation of all eigen values.

$$\text{NPe} = \frac{\lambda_m}{\sum_{i=1}^k \lambda_i} \quad (3)$$

**Table 2.** Proposed Algorithm: Semi Feature Minimum Projection error Minimum Redundancy (S-MPeMR)

<p><b>Input:</b> D: Number of original features, <math>f_1, f_2, \dots, f_D</math> original feature set <math>T_1, T_2</math>: predefined threshold values Dim: Number of features count</p> <p><b>Output:</b> Reduced Feature Set Fset</p> <ol style="list-style-type: none"><li>1. Initialize semi feature set S as F</li><li>2. Generate Fset = <math>\bigcup S</math></li></ol> <p><b>Stage I: Feature Extraction</b></p> <ol style="list-style-type: none"><li>3. For each feature triplet <math>f_i, f_j</math> and <math>f_k</math> in Fset calculate NPe</li><li>4. If <math>Npe(f_i, f_j, f_k) &lt; T_1</math></li><li>5. Se : Calculate Eigen component of <math>f_i, f_j</math> and <math>f_k</math></li><li>6. Add Se in set S</li><li>7. Update S set</li><li>8. Remove <math>f_i, f_j</math> and <math>f_k</math> from Fset</li></ol> <p><b>Stage II: Feature Selection</b></p> <ol style="list-style-type: none"><li>9. For each feature pair <math>f_i</math> and <math>f_j</math> in Fset</li><li>10. <math>Red(f_i, f_j)</math> : Calculate Correlation coefficient as redundancy measure</li><li>11. If <math>Red(f_i, f_j) &gt; T_2</math> then</li><li>12. Rset (<math>f_i, f_j</math>) : generate redundancy feature set</li><li>13. Find variance of each feature in Rset</li><li>14. Find weak feature with minimum variance</li><li>15. Remove feature from Fset</li><li>16. If Fset size matches with dimension count then</li><li>17. Return Fset</li><li>18. Else Continue from step 3</li></ol>
--

### Performance Evaluation Parameters for Clustering Quality Measurement

Once we get compound feature subset after execution of Stage I and Stage II, the efficacy of the proposed S-MPeMR algorithm can be measured by inputting the generated compound feature subset to K-means clustering algorithm. Then Jacc and FM indices are computed with the help actual class labels and predicted class labels in order to assess the clustering quality. The details of these metrics are given below.

#### 1. Jaccard Coefficient (Jacc)

The performance of the proposed S-MPeMR algorithm is calculated clustering quality analysis. If the true labels of a dataset are known, the quality of the applied clustering technique can be computed by finding out the difference between the true labels and the predicted labels. The useful quality measures in this context are Jacc and FM. Thus the generated feature subset quality can be measured using Jacc and FM. Both Jacc and FM can vary between 0 and 1, with 1 indicating complete overlap and 0 indicating no overlap. Thus higher the value of these two coefficients, higher would be the clustering quality.

The Jacc is a statistical method of comparing the similarity between two sets. It is defined as the size of the intersection divided by the size of the union of two label sets, is used to compare set of predicted labels for a sample to the corresponding set of actual labels. Let  $K = K_1, K_2, \dots, K_m$  and  $P = P_1, P_2, \dots, P_n$  be two clustering result set, then Jacc index can be computed using Equation (4).

$$Jacc = \frac{a}{(a+b+c)} \quad (4)$$

Where,

a: Number of point pairs belonging to same cluster set of two clustering results K and P

b: Number of point pairs belonging to same cluster set in K but not in P

c: Number of point pairs belonging to different cluster set in K but same in P.

## 2. Fowlkes Mallows Index (Fm)

This is the cluster evaluation method. This method measure the similarity between two clustering results. The higher value for the FM index shows the higher similarity between the clusters. The score ranges from 0 to 1. A high value indicates a good similarity between two clusters. Let  $K = K_1, K_2, \dots, K_m$  and  $P = P_1, P_2, \dots, P_n$  be two clustering results then FM index can be given by Equation (5).

$$FM = \frac{a}{\sqrt{(a+b)(a+c)}} \quad (5)$$

Where,

a: Number of point pairs belonging to same cluster set of two clustering results K and P

b: Number of point pairs belonging to same cluster set in K but not in P

c: Number of point pairs belonging to different cluster set in K but same in P.

## 4. DISCUSSION ON RESULTS

The Table 3 provides Performance Validation of the proposed S-MPeMR algorithm against MPeMR algorithm. As discussed earlier, the proposed S-MPeMR based approach is evaluated with static threshold values. We can see that the threshold values (T1 and T2) are data dependent for MPeMR approach, whereas the threshold values are kept constant (i.e.  $T_1 = T_2 = 0.5$ ) for all of the five datasets in case of proposed S-MPeMR algorithm. In Table 3, we have compared the values of Jacc and FM for existing and proposed approach in the context of five datasets considered. It is observed that there is a good amount of improvement in Jacc and FM metrics for the proposed S-MPeMR algorithm as compared to the existing MPeMR algorithm. Out of all the five datasets, in case of Yeast dataset, this improvement in Jacc and FM is highest as compared to that for rest of the other four datasets. The Table 3 also provides the statistics of total data dimension (number of features), and reduced data dimension for these five datasets. From this statistics it is clear that after applying the proposed S-MPeMR technique, a significant reduction in the data dimension is observed. The dimensionality reduction is found to be highest for the Movement Libras dataset.

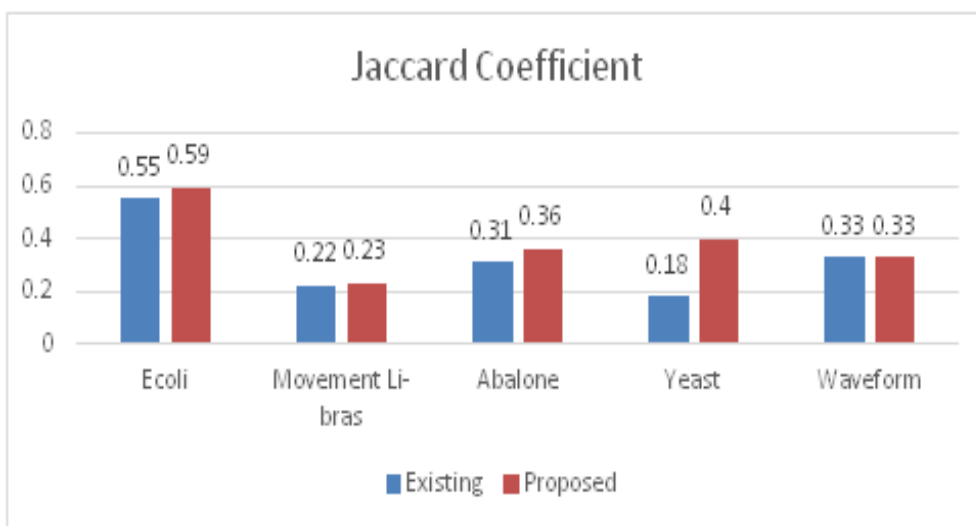
As discussed in the Section 3, once we apply the proposed S-MPeMR algorithm on these five datasets, we get the compound feature subset with reduced data dimension (i.e. dimensionally reduced datasets). In order to test the efficacy of the proposed S-MPeMR algorithm against MPeMR algorithm, we applied K-means clustering on all of these five dimensionally reduced datasets, and noted down the clustering accuracy. By observing the K-means clustering accuracy for both the approaches, it is clear that the clustering accuracy of the proposed S-MPeMR algorithm is improved in the context of all of the five dataset categories. Thus instead of setting threshold values data specific, setting these as static yield significant improvement in Jacc, FM indices as well as clustering accuracy. Thus we can firmly say that the proposed S-MPeMR algorithm outperforms the existing MPeMR algorithm.

**Table 3.** Performance Validation of proposed S-MPeMR algorithm against MPeMR algorithm

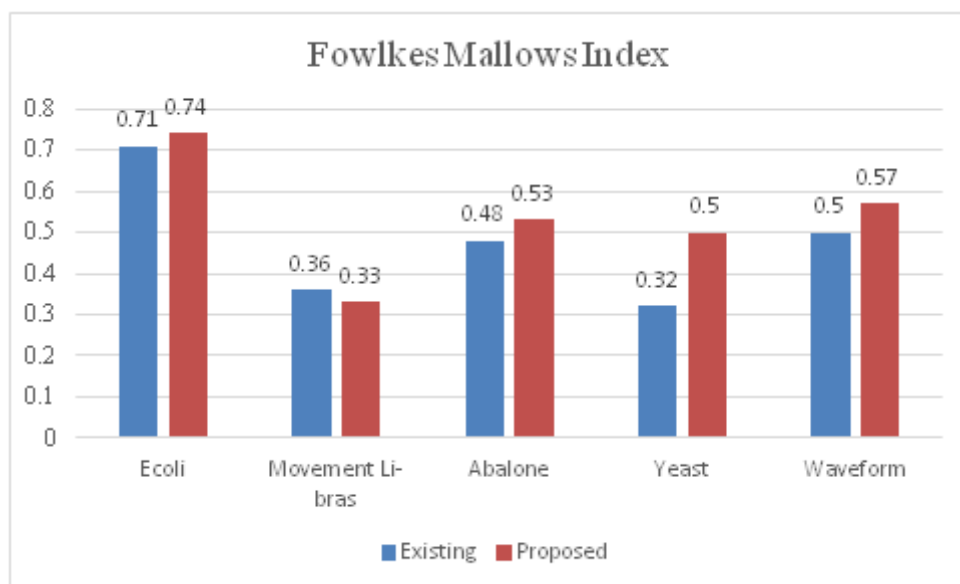
Sr. No.	Dataset	MPeMR (Existing Approach)				S-MPeMR (Proposed Approach)				S-MPeMR (Proposed Approach)		K-means Clustering Accuracy	
		T1	T2	Jacc	FM	T1	T2	Jacc	FM	Total Dimensions	Reduced Dimensions	MPeMR [9]	S-MPeMR R
1	Ecoli	0.3	0.5	0.55	0.71	0.5	0.5	0.59	0.74	8	5	85.42	91.77
2	Movement Libras	0.07	0.8	0.22	0.36	0.5	0.5	0.23	0.33	90	15	85.07	86.4
3	Abalone	0.1	0.9	0.31	0.48	0.5	0.5	0.36	0.53	8	3	63.33	91.19

4	Yeast	0.38	0.6	0.18	0.32	0.5	0.5	0.4	0.5	8	4	60.72	61.21
5	Waveform	0.3	0.7	0.33	0.50	0.5	0.5	0.33	0.57	40	14	85.21	86.6

The existing MPeMR and the proposed S-MPeMR algorithms are also compared graphically to understand the efficacy of the proposed S-MPeMR algorithm in the context of Jacc, FM, and dimensionality reduction performance in Figure 2, Figure 3, and Figure 4 respectively. Figure 2 gives performance comparison on all three datasets for existing and proposed approach. Existing work is represented by blue bars and maroon bars shows proposed work. In contrast to existing system where T1 & T2 are kept dataset dependent, here values of T1 & T2 are kept as static which has given considerable performance improvement. As shown in Figure 2 considerable performance improvement is seen in Jacc values. FM gives similarity between two clustering (clusters which are obtained after clustering algorithms). Higher the value of FM defines high similarity between two clusters which also be a benchmark for classification. As shown in Figure 3 considerable improvement is seen in FM values in proposed approach. One of the important main aim of this research work is dimensionality reduction. As shown in Figure 4, significant reduction of dimension is achieved. For Ecoli dataset dimensions are reduced from 8 to 5. For Movement Libras dataset reduction is done from 90 to 15 and for Abalone dataset dimensions are reduced from 8 to 3. Considering Jacc, FM parameter values and dimensionality reduction, proposed S-MPeMR algorithm outperforms on existing system. Dimensionality reduction is achieved with preserving similarity between two clusters, which is proved with improved values of Jacc and FM indices.



**Figure 2.** Performance comparison of Jaccard Coefficient (Jacc) for all considered five dataset.



**Figure 3.** Performance comparison of Fowlkes Mallows Index for all considered five dataset.

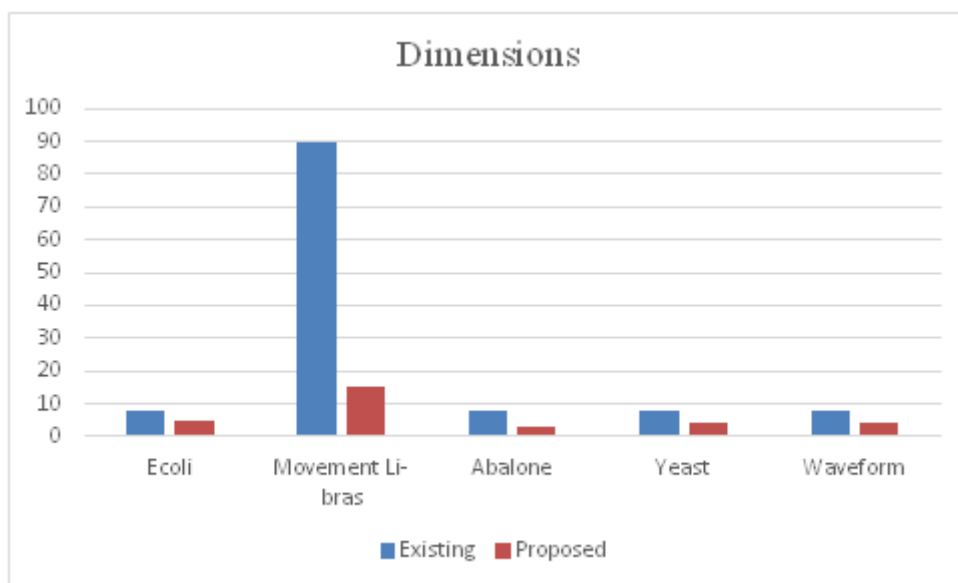


Figure 4. Dimensionality reduction comparison for all considered five dataset.

## 5. CONCLUSION AND FUTURE SCOPE

In this research work, a novel approach for dimensionality reduction with the aim of providing reduced sets with original and combinations of features without losing orthogonality property is presented. The proposed algorithm is named as Semi Feature Minimum Projection error Minimum Redundancy (S-MPeMR) algorithm in which feature selection and feature extraction methods are used to generate compound feature set using semi features. For feature extraction MPeMR technique is used, wherein initially semi features are extracted using NPe technique by checking orthogonality among selected original features and combination of features. This proposed S-MPeMR algorithm adopts the benefits of both feature extraction and feature selection techniques. For feature extraction, the proposed method uses PCA technique, wherein the data features are merged on the basis of NPe. The feature selection technique is applied on a Fest. Fest is generated using original features set and semi feature set. In order to test the efficacy of the proposed S-MPeMR algorithm against MPeMR algorithm, we applied K-means clustering on all of these five dimensionally reduced datasets, and noted down the clustering accuracy. By observing the K-means clustering accuracy for both the approaches, it is clear that the clustering accuracy of the proposed S-MPeMR algorithm is improved in the context of all of the five dataset categories. Thus instead of setting data specific threshold values, setting static threshold values yield significant improvement in Jacc, FM indices as well as clustering accuracy. Thus we can firmly say that the proposed S-MPeMR algorithm outperforms the existing MPeMR algorithm.

## REFERENCES

1. M. Robnik-Sikonja and I. Kononenko, "Theoretical and empirical analysis of ReliefF and RReliefF," *Machine learning*, vol. 53, no. 1-2, pp. 23-69, 2003.
2. F. Nie, S. Xiang, Y. Jia, C. Zhang, and S. Yan, "Trace ratio criterion for feature selection." in *AAAI*, vol. 2, 2008, pp. 671-676.
3. Z. Zhao, L. Wang, H. Liu, and J. Ye, "On similarity preserving feature selection," *Knowledge and Data Engineering, IEEE Transactions on*, vol. 25, no. 3, pp. 619-632, 2013.
4. D. Wang, F. Nie, and H. Huang, "Global redundancy minimization for feature ranking," *Knowledge and Data Engineering, IEEE Transaction on*, 2015.
5. W. Sheng, X. Liu, and M. Fairhurst, "A niching memetic algorithm for simultaneous clustering and feature selection," *Knowledge and Data Engineering, IEEE Transactions on*, vol. 20, no. 7, pp. 868-879, 2008.
6. X. He, D. Cai, and P. Niyogi, "Laplacian score for feature selection," in *Advances in neural information processing systems*, 2005, pp. 507-514.
7. D. Cai, C. Zhang, and X. He, "Unsupervised feature selection for multi-cluster data," in *Proceedings of the 16th ACM SIGKDD international conference on Knowledge discovery and data mining*. ACM, 2010 333-342.

8. Z. Xu, I. King, M. R.-T. Lyu, and R. Jin, "Discriminative semi super-vised feature selection via manifold regularization," *Neural Networks, IEEE Transactions on*, vol. 21, no. 7, pp. 1033-1047, 2010.
9. Sreevani and C.A. Murthy, "Bridging Feature Selection and Extraction: Compound Feature Generation," *IEEE Transactions on Knowledge and Data Engineering*, Vol. 29, No. 4, pp. 757 - 770 , April 2017.
10. P. Mitra, C. Murthy, and S. K. Pal, "Unsupervised feature selection using feature similarity," *IEEE transactions on pattern analysis and machine intelligence*, vol. 24, no. 3, pp. 301-312, 2002.
11. R. Kohavi and G. H. John, "Wrappers for feature subset selection," *Artificial intelligence*, vol. 97, no. 1, pp. 273- 324, 1997.
12. B. Efron, T. Hastie, I. Johnstone, R. Tibshirani et al., "Least angle regression," *The Annals of statistics*, vol. 32, no. 2, pp. 407-499, 2004.
13. H. Li, T. Jiang, and K. Zhang, "Efficient and robust feature extraction by Maximum Margin Criterion," *Neural Networks, IEEE Transactions on*, vol. 17, no. 1, pp. 157-165, 2006.
14. S. Liu, L. Feng, and H. Qiao, "Scatter balance: an angle-based supervised dimensionality reduction," *Neural Networks and Learning Systems, IEEE Transactions on*, vol. 26, no. 2, pp. 277-289, 2015.
15. H. Zou, T. Hastie, and R. Tibshirani, "Sparse principal component analysis," *Journal of computational and graphical statistics*, vol. 15, no. 2, pp. 265-286, 2006.
- A. Hyvarinen and E. Oja, "Independent Component Analysis: algo-rithms and applications," *Neural networks*, vol. 13, no. 4, pp. 411-430, 2000.
16. <http://archive.ics.uci.edu/ml/datasets.html>/accessed on: 5<sup>th</sup> Feb 2022.





Dr. Guruprasad B G is the Principal in Surana Evening College, KS Town, Bangalore & Asst. Professor, Jain (Deemed to be University), Jayanagar, Bangalore. He has done is Master in Commerce. He has got his Doctorate degree on the topic "Mobilisation of Investment & Fund Savings by NBO". He has published several research papers in reputed national, international & UGC care journals and authored 6 books. Accounting, Finance & taxation is his area of expertise. He has 12 years of experience in teaching at graduate & post-graduate. Delivered many lectures as keynote speaker and reviewed many research papers.



SHREE HARSHA C is Working as an Assistant Professor, Department of Management, Surana College South end Bangalore. He pursued his MBA, Specialized in Finance from SJB Institute of Technology, Visvesvaraya Technological University. He has also Pursued MA (Economics) and Post Graduate Diploma in International Business operations (PGDIBO) from IGNOU. His Area of Interest includes Finance, Accounting and Management subjects.



Mrs. Usha K is presently working as an Assistant Professor, Department of Commerce, Government First Grade College, Koppa, Chikmagalur District. She has completed her M.Com from Bangalore University with specialization in "Accounting and Taxation". She has 12 years of teaching experience in pre- University, Degree and Post graduate colleges. Also published research articles in peer reviewed journals, national and international publications.



**Sapna Book House**

3<sup>rd</sup> Main Road, Gandhinagar, Bangalore - 560 009  
Ph : 40114455

Shop online : [www.sapnsonline.com](http://www.sapnsonline.com)

ISBN : 978-93-5456-215-0



Price : ₹ 280/-

Sapna

Sapna

Dr. Guruprasad B.G.  
Shree Harsha C.  
Usha K.

FINANCIAL ACCOUNTANCY

I  
B.Com.  
NEP

As per the New NEP Syllabus

# FINANCIAL ACCOUNTANCY

For I Semester B.Com of All Universities of Karnataka



- Dr. Guruprasad B.G.
- Shree Harsha C.
- Usha K.





**Dr. Guruprasad B G** is the Principal in Surana Evening College, KS Town, Bangalore & Asst. Professor, Jain (Deemed to be University), Jayanagar, Bangalore. He has done is Master in Commerce. He has got his Doctorate degree on the topic "Mobilisation of Investment & Fund Savings by NBO". He has published several research papers in reputed national, international & UGC care journals and authored 6 books. Accounting, Finance & taxation is his area of expertise. He has 12 years of experience in teaching at graduate & post-graduate. Delivered many lectures as keynote speaker and reviewed many research papers.



**Dr. A. Arunprakash**, M.Com., Ph.D., M.F.A., is an Assistant Professor in the Department of Commerce, School of Commerce at Jain (Deemed-to-be University) Bangalore. A passionate reader and an academician by profession, thrive in bringing out the excellence of teaching and learning. He has five years of Research Experience and three years of teaching experience.



**SHREE HARSHA C** is Working as an Assistant Professor, Department of Management, Surana College South end Bangalore. He pursued his MBA, Specialized in Finance from SJB Institute of Technology, Visvesvaraya Technological University. He has also Pursued MA (Economics) and Post Graduate Diploma in International Business operations (PGDIBO) from IGNOU. His Area of Interest includes Finance, Accounting and Management subjects.



**JAGADISHA J**, M.com., NET, K-SET, is an Assistant Professor in the Department of Commerce, GFGC Hirisave, Department of Collegiate Education Bangalore. A passionate teacher and academician by profession, thrive in bringing out the excellence of teaching and learning. He has nine years of Research Experience and nine years of teaching experience in private and government colleges.



**Sapna Book House**

3- Main Road, Gandhinagar, Bangalore - 560 009  
Ph : 40114455

Shop online : [www.sapnaonline.com](http://www.sapnaonline.com)

ISBN : 978-93-5456-221-1



Price : ₹110/-

FINANCIAL ACCOUNTANCY

Dr. Guruprasad B.G., Dr. A. Arunprakash, Shree Harsha C. & Jagadisha J.

As per the New NEP Syllabus

# PRINCIPLES OF MARKETING

For I Semester B.Com of All Universities of Karnataka



Sapna

- Dr. Guruprasad B.G.
- Dr. A. Arunprakash,
- Shree Harsha C.
- Jagadisha J.



Dr. Guruprasad B.G, M.Com, Ph.D. is serving as principal in Surana Evening College, Bangalore. An author, original thinker, passionate educationalist, and strategic leader in education management. Has 13 years of experience in teaching at Graduate, Postgraduate, and Professional levels, and 6 years of research experience.

Accounting, finance, and taxation are his area of interest. He has given the keynote address at various prestigious schools and colleges. He has to his credit 10 books and 8 research papers published in the prestigious journals Scopus index and UGC Care List.



Dr. Nasreen Sayyed is currently working as an Assistant Professor, School of Commerce Studies, Jain (Deemed-to-be University) for the last 12 years. She had been associated with the Royal College of Commerce Affiliated with Mumbai University from 2004 to 2009. She obtained a Ph.D. degree in Commerce from Mother Teresa

Women's University in 2021. She has so far published 3 research papers in Scopus-indexed journals and 12 papers in international and national journals. She has also presented various papers at national and international conferences on Finance and Accountancy.



SHREE HARSHA C is Working as an Assistant Professor, Department of Management, Surana College South end Bangalore. He pursued his MBA, Specialized in Finance from SJB Institute of Technology, Visvesvaraya Technological University. He has also Pursued MA (Economics) and Post Graduate Diploma in

International Business operations (PGDIBO) from IGNOU. His Area of Interest includes Finance, Accounting and Management subjects.



**Sapna Book House®**

3- Main Road, Gandhinagar, Bangalore - 560 009  
Ph : 40114455

Shop online : [www.sapnaonline.com](http://www.sapnaonline.com)

ISBN : 978-93-5456-107-8



Price : ₹ 295/-

Dr. Guruprasad B.G.  
Dr. Nasreen Sayyed  
Shree Harsha C.

Sapna

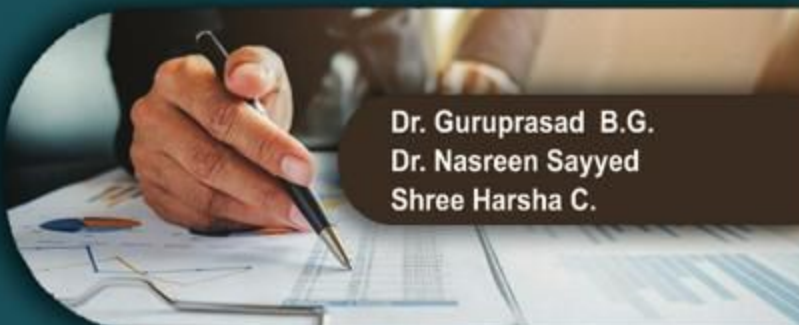
Sapna

As per the New NEP Syllabus

# ADVANCED FINANCIAL ACCOUNTANCY

DSC - 2.1

For II Semester B.Com of All Universities of Karnataka



Dr. Guruprasad B.G.  
Dr. Nasreen Sayyed  
Shree Harsha C.



Dr. Guruprasad B.G, M.Com, Ph.D. is serving as principal in Surana Evening College, Bangalore. An author, original thinker, passionate educationalist, and strategic leader in education management. Has 13years of experience in teaching at Graduate, Postgraduate, and Professional levels, and 6 years of research experience. Accounting, finance, and taxation are his area of interest. He has given the keynote address at various prestigious schools and colleges. He has to his credit 10 books and 8 research papers published in the prestigious journals Scopus index and UGC Care List.



Mr. Uday Kumar C is working as an Assistant Professor, Department of Commerce in Surana Evening College, Kengeri, Bangalore. He pursued his Master of Commerce specialized in Accounting & Taxation from Bangalore University. He has cleared UGC NET and K-SET Examinations. His Area of Interest includes Accounting, Taxation, Costing, Finance and Marketing subjects. He has presented Research Papers in National Level Conferences and actively attended many Seminars, Workshops and Faculty Development Programmes. He also authored (a) Business Dynamics and Entrepreneurship, (b) Indian Financial Institutions & Markets text books for B.Com Course of Bangalore Central University.



Sree Harsha C is Working as an Assistant Professor, Department of Management, Surana College South end Bangalore. He pursued his MBA, Specialized in Finance from SJB Institute of Technology, Visvesvaraya Technological University.

He has also Pursued MA (Economics) and Post Graduate Diploma in International Business Operations (PGDIBO) from IGNOU. His Area of Interest includes Finance, Accounting, and Management subjects.



Mrs. Anusha S graduated from the University of Mysore and completed her post-graduation from the Department of Commerce, Manasa Gangotri Mysore, and currently pursuing her Ph.D. at Manasa Gangotri Mysore. Presently she is working as an assistant professor at Seshadripuram Degree College Mysore for the past 6 years.



**Sapna Book House**

3- Main Road, Gandhinagar, Bangalore - 560 009  
Ph : 40114455

Shop online : [www.sapnaonline.com](http://www.sapnaonline.com)

ISBN : 978-93-5456-091-8



Price: ₹225/-

Dr. Guruprasad B.G, Mr. Uday Kumar C,  
Sree Harsha C & Mrs. Anusha S

Banking Innovations

As per the New NEP Syllabus

# Banking Innovations

DSC - 2.3

For II Semester B.Com of All Universities of Karnataka

- Dr. Guruprasad B.G
- Mr. Uday Kumar C
- Sree Harsha C
- Mrs. Anusha S

Sapna



**Blue Rose Publisher**

4233/1 Main Ansari Road Near Allahabad Bank,  
Dariyaganj, Delhi- 110002



BlueRose ONE  
Stories Matter

ISBN: 978-93-5668-523-9

Certificate No.: EBS/2022/14 Date: 24/10/2022

## CERTIFICATE OF PUBLICATION

This is awarded to Dr./Mr./Ms. .... **Dr. Farzana Tasneem MI** .....

..... **Head, Dept of Biotechnology, Surana College, Bangalore (Karnataka) India** .....

..... in recognition of his/her outstanding book chapter/article .....

..... **Parasitic Fungal Diseases** .....

..... Published in the edited book Entitled .....

**Research in Mycology: Volume-I**

**Mr. Balwant Singh**  
*Managing Editor*



**Prof. Shailendra Kumar**  
*Editor of Honour*

**Dr. Vinay Kumar Singh**  
*Editor in Chief*

# **New Horizons in Commerce & Management**

**Volume -9**

**Sanjeev Kumar  
Ms Remya S**

Edition 1

First Edition 2022  
HIGH RISE BOOKS

Amazon Publishers  
[www.kdp.amazon.com](http://www.kdp.amazon.com)

New Horizons in commerce and management  
Volume -9

**ISBN:** 9798833320044

Imprint : Individually published

All rights reserved. No part of this publication may be reproduced, stored in a retrieval or transmitted in any form or by any means: electronic, mechanical, recording or otherwise, without the prior written permission of the author. This book has been published with all reasonable efforts taken to make the material error-free after the consent of the author. The author of the book and full-length research paper donors are responsible and its content including but not limited to the views, representations, descriptions, statements, information, opinions and references. The publisher does not endorse or approve the content of this book or guarantee the reliability, accuracy or completeness of the content published herein. The publisher and the author make no representations or warranties of any kind concerning this book or its contents.

# Chapter – 10

## Technology – Tourism Interface: An Emerging Trend

**By : Prof. Savita Shastri, M. Com, PGDBA, MA,**  
Assistant Professor, Department of MBA, Surana College, Bangalore

### ABSTRACT

Technology has had great impact on the tourism as well as other sectors affiliated to tourism such as transport, communication, and travel agencies. Over the years, the use of technology in tourism has been enhanced uniquely to provide very exclusive services across the globe. In the recent past when technology was rarely used in the tourism sector, most services were of very poor quality and equally unreliable. However, with time technology has gone a long way in improving the quality-of-service delivery in the tourism sector.

The application of technology in tourism, whether it be in the vacation-planning process or during the actual vacation, is changing the entire landscape of the travel industry. Majority of the Generation Y and Generation Z travelers find it convenient to book a hotel online and to plan their travel using online sources. According to Think with Google's '5 Stages of Travel,' an average traveler visits about 22 travel-related sites prior to booking a vacation and 70 percent of business travelers will check into their flights and hotels via their mobile devices. It's no wonder then, that technology and tourism are becoming closely intertwined.

This paper aims at throwing light on the Technology – Tourism interface. It brings out the various aspects where technology has cast an influence on the dynamics of the travel and tourism sector. Technology driven tourism is emerging as the need of the hour. Technology driven tourism helps to replace expensive human labor with technological labor, thus not only reducing labor costs but also avoiding issues of customer service. Yet technology may produce a whole new set of unintended consequences.

**Keywords:** Travel, Tourism, Technology, Customer Service, Generation Z, Technology-Tourism Interface

## ***Introduction***

Technology has become indispensable and sort of a mixed bag for the tourism industry. It creates a great deal of conveniences while at the same time it has been used to increase revenues and to lessen customer service. The world of technology has made air travel safe and abundant but has also brought about the need to go through long security lines and daily hassles. Certainly, some parts of the industry have begun to use technology prudently. When used ethically, technology can be a great help in increasing our communication and security. If on the other hand technology is used for selfish or destructive purposes than it can become a nemesis within the travel and tourism industry. Hamlet's question "to be or not to be" has never seemed more poignant in its relationship to travel and tourism.

Generation Z also called as the 'Internet Generation' is well versed with smart phones, tablets, and all communication devices. They prefer dependence on technology vis-à-vis dependence on humans. The Tech savvy generation finds it easier to read reviews and choose hotels, prefers to make online bookings and payments, and opts for GPS enabled travel. All aspects of travel and tourism have been impacted by the advent of technology.

## ***Technology-Tourism Interface***

The face of the travel industry has undergone significant changes over the past decade. Much of these changes are attributed to developments in the information technology, services and applications coupled with the increasing competitive environment. All the sections in the travel industry are affected with the advent of internet and related information and communication technologies. The airlines as suppliers, travel agencies as service providers, and the consumers of such services i.e. the travelers. There are positive impacts on the travel industry such as improvement in the distribution channels and disintermediation. But there are also negative impacts on the industry such as price transparency and reduced customer loyalty (Michael, 2014). Along with this paradigm shift, is the changing consumer purchasing habits when it comes to buying airline tickets or doing hotel bookings. Travelers have the ready option of booking and buying online rather than through the traditional travel agencies or tour operators. Technology has simplified the whole travel experience and taken it to a different level. There is no aspect of tourism that remains unexposed to the technology onslaught. Some of the aspects where technology has impacted Tourism are mentioned below.

## ***Technology in Travel Planning***

Technology has changed the way things are done, the tasks which took hours and days, now can be done in minutes by surfing through few websites. Traveling has evolved with the advent of technology. People were apprehensive and jittery while planning their travel as it was time



consuming and complex process. Technology has made travel planning simpler and easier as it consumes less time. The use of smart tourism technologies such as travel-related websites, social media, and smartphones in travel planning has been pervasive and growing. According to a Google Travel study, 74% of travelers plan their trips on the Internet, while only 13% still use travel agencies to prepare them (C Derrick & Jahyun, 2017).

First and foremost, travelers can browse through the different travel destinations, read the reviews while deciding on the place of travel. Websites like Farandwide.com brings out 'Top 30 Travel Destinations in the world' which one can look at and decide. Traveler could customize his search and look for travel destinations within a specific country or a specific region. Some of the websites that provide information on Travel destination are [www.odynovotours.com](http://www.odynovotours.com), [www.thrillophilia.com](http://www.thrillophilia.com), [www.planetware.com](http://www.planetware.com), and [www.holidify.com](http://www.holidify.com).

Secondly flight and train bookings have always been an expensive affair when handled by travel agents. Consumers now have the option of buying online instead of through the traditional travel agencies which perform services for the consumers such as bookings, issuance of tickets and collection of payments on behalf of the airlines. Today one could use IRCTC website to do direct train bookings anywhere in the country for their preferred date and class of travel. Flight bookings could either be done through airline websites or through travel websites like Make my trip, Go Ibibo, Yatra, Clear Trip etc. Most of these travel engines offer discounts to travelers on flight bookings which proves to be very cheap as compared to using the services of travel agents. One could also do web check in, download e-boarding pass, and avoid the long queues at the airports.

### ***Technology in Hotel Bookings***

The whole hospitality ecosystem revolves around the concept of hotel bookings and the role that information technology plays in hotel industry is irrefutable. The internet has opened several windows for hotels to explore when it comes to increasing bookings and occupancy. Travelers can compare hotel prices and offers across different websites and choose the preferred hotel.

The hotels use ICT to communicate with their customers about check-in timings, airport pickups, location updates and any special requests. Hotels have also brought in technology as part of their guest experience strategy as the modern-day traveler expects no less. This explains why several hotels now provide keyless room access (via smartphone), smart control for

multiple devices in the room (AC, heater, upholstery), tablets to place in-room dining orders or other requests. The whole idea is to make the experience at the hotel a technology driven one.

With the advent of Web 2.0 and rapid growth of Tourism 2.0 applications, today internet stores millions of online reviews and user ratings about nearly every lodging facility around the world. Annually millions of travelers consult these reviews and check the ratings to select hotels. Currently hotel review websites (tripadvisor.com, trivago.com) are among the most visited websites in internet and many of hotel online booking websites (booking.com) allow users to post online reviews about the hotels they have booked (Shahab, 2014).

Social networking portals like Facebook, Twitter, Instagram etc. are increasingly playing a dominant role in marketing strategies of hotels all over the world. User generated feedback and reviews on such websites play a huge role in popularizing the services of hotels by word of mouth. Further, the use of information technology in hotel industry has also enabled hoteliers to stay in touch with and nurture relationships with guests by making use of online tools. Travelers are lured with reward points for the reviews and feedback posted by them (Meikun, 2014).

### ***Technology in Travel Experience***

The creation of rich and memorable experiences represents a key concept in tourism research and practice. Currently experiences are undergoing a drastic change as increasing consumer empowerment and technology use are the driving forces revolutionizing the nature of tourist experiences (Barbara, 2014). Destination marketers should start treating the Web 2.0 tools as a new opportunity to reach out on the marketplace and see them as a mechanism to learn about tourists' opinion of the destination, as well as the stories, comments, advice, and pictures tourist share. Knowledge about customer experiences, value creation and motives can be vital when making relevant and competitive experience design. Through a SEM- decision tree approach, new dimensions and connections of value dimensions and behavioral intentions within the tourist experiences can be indicated (Lalicic, 2014).

The language barrier is a major issue people face when people are travelling in a foreign land. The technology has made it possible for travelers not to get hindered by the language barrier. There are translation apps that can make it possible to communicate with the natives and makes

the travel experience enjoyable and pleasant. These translation apps have option of voice, text and camera translation and can even work offline when there is no internet available. Using these apps travelers could access local services, book cabs, order food and communicate with locals. Some of the famous Translation Apps are Google Translate, TripLingo, Papago, SayHi, and WayGo.

Traveling to the desired destination has also become simpler with the use of apps like Google Maps. It has made navigation and travel easy, users have the option to explore the route they want to take depending on whether they are in a car, public transport, or walking. The application also helps the traveler to navigate areas of interest like clubs, bars, restaurants enroute their destination.

To address young traveler's needs, the tourism industry has also implemented new mobile technologies, which combine both elements – entertainment of video games and learning about cultural facts in a new phenomenon to engage visitors with the holiday destination (Jessika, 2014). The growing availability and popularity of social media has transformed the way people communicate, make decisions, socialize, learn, and interact with each other. With the acceleration of internet and interactive power of social media, consumers are now creating new meanings and values about the tourism products and brands that are beyond the full control of tourism organizations.

### ***Conclusion***

Today technology finds its place in almost every aspect of the tourism industry. From planning a vacation to booking a hotel, from ordering food during travel to providing feedbacks, technology has permeated all layers. If we are smart enough to use the benefits of technology such as convenience, speed, and accuracy and avoid some of the pitfalls such as user friendliness, size of lettering, data phishing and lack of human contact, then technology can be a great time and cost saver. But if the tourism industry forgets the importance of the human element and that tourism is all about the experience then it is bound to bring adverse impact on the business over a period of time.

Tourism organizations around the world need to understand a) how and where technology needs to be implemented before, during and after the tourists arrive at the destination, b) how technology enables more engaging co-creation encounters and c) what overall factors need to

be fulfilled to create dynamic and competitive technology-enhanced experiences in the future in the right place and at the right time.

### ***References***

Barbara, N., 2014. The Technology Enhanced Tourist Experience. In: R. Baggio, ed. *Information and Communication Technologies in Tourism 2014*. Dublin: s.n., pp. 90-110.

C Derrick, H. & Jahyun, G., 2017. Smart Tourism Technologies in Travel Planning: The Role of Exploration and Exploitation. *Information and Management*, January.54(6).

Jessika, W., 2014. Augmented Reality Gaming: A new Paradigm for Tourist Experiences. In: R. Baggio, ed. *Information and Communication Technologies in Tourism 2014*. Dublin: s.n., pp. 57-64.

Lalicic, L., 2014. Unwrapping the Tourist Experience; A SEM Decision-tree Approach. In: *Information and Communication Technologies in Tourism 2014*. Dublin: s.n., pp. 115-120.

Lori, Z., 2020. *9 Best Translation Apps for Travel*. [Online]

Available at: <https://thepointsguy.com/>

[Accessed 25 January 2022].

Meikun, L., 2014. The Influence of Social Media on Hotel Brand Personality. In: *Information and Communication Technologies in Tourism 2014*. Dublin: s.n., pp. 25-131.

Michael, Y., 2014. Factors Affecting Consumers' Attitude and Intention toward Online Airline Ticketing. In: R. Baggio, ed. *Information and Communication Technologies in Tourism 2014*. Dublin: s.n., pp. 140-149.

Prabhash, B., 2011. *The Importance and Use of Technology in today's Hospitality Industry*. [Online]

Available at: <https://www.hotelogix.com/>

[Accessed 30 January 2022].

Shahab, P., 2014. The Impact of Users' "Online Reviews" and "Ratings" on Consumers' Behaviour toward Hotel Selection Factors. In: *Information and Communication Technologies in Tourism 2014*. Dublin: s.n., pp. 107-110.

Williampadilla, 2019. *How Technology Has Changed the Way You Travel*. [Online]

Available at: <https://www.traveldailymedia.com/>

[Accessed 25 January 2022].



**JAIN**  
DEEMED-TO-BE UNIVERSITY

CENTER FOR  
MANAGEMENT  
STUDIES

**AVLOKAN 2.0**



# Entrepreneurship and Human Resource Management

Proceedings of International Entrepreneurship Summit on Beyond Sustainability-  
Trends in Regenerative, Socially Responsible, Community Ventures

## Editors

Dr. Dinesh Nilkant  
Dr. Varsha Agarwal  
Prof. Sunitha B K



# **Entrepreneurship and Human Resource Management**

**Editors:**

**Dr. Dinesh Nilkant  
Dr. Varsha Agarwal  
Prof. Sunitha B.K.**

*Proceedings of International  
Entrepreneurship Summit on Beyond  
Sustainability-Trends in Regenerative,  
Socially Responsible, Community Ventures*

**AVLOKAN 2.0**

**Eureka Publications**

While every effort has been made to trace copyright holders and obtain permission, this has not been possible in all cases. Any omissions brought to our attention will be remedied in future editions.

All rights reserved.

No part of this publication may be reproduced, transmitted, or stored in a retrieval system, in any form or by any means, electronic, mechanical, photocopying, recording or otherwise, without the prior permission of the publisher.

**ISBN: 978-93-91260-28-6**

First Edition - 2022

The moral right of the authors has been asserted.

The book is sold subject to the condition that it shall not, by way of trade or otherwise, be lent, resold, hired out, or otherwise circulated, without the publisher's prior consent, in any form of binding or cover other than that in which it is published.

**Published By:**

**Eureka Publications**  
**(A Division of EnTo Tech Pvt. Ltd.)**

**India Office:** 604, The Poorva, Pimple Saudagar, Pune, Maharashtra - 411027

**Philippines Office:** 9495, Bankal Street, Lopez Village, Batong Malake, Laguna, 4031, Philippines.

**Malaysia Office:** No 26, Jalan Pulau Indah, u10/53 Taman Sandaran Permai, Seksyen u10, Shah Alam 40170, Malaysia.

**Phone No:** +91-9826601628

**E-mail Id:** [info@eurekajournals.com](mailto:info@eurekajournals.com), [editor@eurekajournals.com](mailto:editor@eurekajournals.com)

**Publisher Disclaimers**

The responsibility for the content/opinions provided in the articles published in the present book is exclusive of the author(s) concerned. Eureka Publication/ its editors/ associates of the book is not responsible for errors in the contents or any consequences arising from the use of the information contained in it. The opinions expressed in the chapters in this book do not necessarily represent the views of the publisher/ editor of the book.

# Employee Perception and Coping Mechanism to Ward off Rising Stress Levels in Remote Working

**Prof. Savita Shastri<sup>1</sup>**

<sup>1</sup>M. Com, PGDBA, MA, Assistant Professor,  
Department of MBA, Surana College, Bangalore.  
**Email id:** savita.mba@suranacollege.edu.in

## *Abstract*

*Stress has become the most experienced problem these days amongst all age groups. The reasons for stress could be work related or due to failure of personal relationships in this challenging lifestyle. A certain level of stress is manageable and essential for us to achieve high potential; however, the threshold of stress varies from person to person. Stress owing to internal and external exigencies can have a detrimental effect on career and personal life.*

*The concept of Remote Working also referred in simple parlance as 'Work from Home' has emerged as the HR Trend of the decade. The Covid-19 pandemic has given way to the concept of employees working from their respective homes with long working hours. The IT, Manufacturing, Telecommunication, and many other sectors have adapted to the concept of Remote Working, and it has also been beneficial from time and cost point of view. The stress involved in working from home is a topic of interest as the dynamics of workplace and work have changed.*

*This paper analyses the employee perception towards stress in remote working and the coping mechanism adopted by them to combat stress. The findings state that majority of the respondents agreed to high levels of stress in remote working. Statistics indicate that women face higher levels of stress in remote working as compared to men. Family support and organizational support emerged as the coping strategies that employees depend on to ward off rising stress levels.*

**Keywords:** *Stress, Employee Perception, Remote working, Coping Mechanism, Covid-19, IT Sector, Gender Perspective.*



## **Introduction**

Stress has become an inseparable part of our lives. Family, Society, Relationships, Work are all catalysts of stress. Work related stress has always been very common in people employed in the private sector, but this has also found a place with employees in the public sector. Competitive environment and the urge to make it big in life in a short amount of time brings in enormous pressure. The stress level among employees decreases the performance and deteriorates the physical and intellectual functioning. High stress affects the creative performance and results in forgetfulness, frequent mistakes, restlessness, lack of concentration or irritability.

Covid-19 restricted people from moving out of their homes and brought work to their homes. The working hours were redefined, the work patterns were realigned, work and the home environment became the work environment. Remote working or work from home concept came in with its pros and cons. On one hand the travel time and stress were reduced, on the other hand the line separating the work and family time became blur. The levels of stress faced by male and female employees in remote working are different and their strategies to cope with this is equally different. Effective coping mechanism is needed to ward off rising stress levels in remote working.

## **Theoretical Background**

Stress is a universal element experienced by employees around the globe. Stress has become major problem for employer particularly in developing nations where the employer doesn't realize the impact of stress on employee performance which ultimately results in critical managerial dilemmas (Subha & Shakeel, 2009).

Stress is the feeling of being overwhelmed and unable to cope with mental and emotional turmoil. Stress can be defined as "Psychological or Physiological imbalance resulting from the disparity between situational demand and the individual's ability or motivation to meet those demands". The term stress was first used by Hans Selye in 1920's in relation to patients in a hospital environment. Later the term stress began to be used extensively as a more generic term associated with all professions.

The causes of stress known as ‘Stressors’ could be classified as Organizational Stress and Non-organizational Stress. Lack of Role clarity, long work hours, unhealthy work environment, competitive pressures and career obstacles can be identified as the Organizational Stress factors. Health issues, family problems, financial constraints, work life imbalance are primary reasons that cause stress. Sleep disturbances, irritable behaviour, conflicts and arguments, low confidence, emotional breakdowns are some of the symptoms of stress. Unmanaged stress results in both physical as well as mental health issues. In this fast-paced competitive environment stress is inevitable, managing it well is the only way to survive and stay put.

The concept of Remote Working has been followed in IT sector for some time. Owing to the travel restrictions during pandemic this concept has been adopted by other sectors too. However, working from home during pandemic differs from the previous remote working arrangements in many ways. To start with this is involuntary, neither the employer nor the employee was looking forward to this arrangement. The second difference is that this form of remote working is far more intensive. The third reason which makes this remote working different is that all the members of employee’s family were present at home, which makes it challenging in maintaining work-life balance.

As stress is unavoidable, each one of us must have a coping mechanism in place to manage stress. Coping is defined as the thoughts and behaviours mobilized to manage internal and external stressful situations. Generally, coping is divided into reactive coping (a reaction following the stressor) and proactive coping (aiming to neutralize future stressors). Coping mechanism could be problem focussed or outcome focussed (Emad & Vikas, 2021).

## **Literature Review**

The COVID-19 pandemic affected the relationship between work and life almost everywhere on the planet. Suddenly, remote work became the mainstream way of working for millions of workers. It is important to understand the relationship between remote work and stress, including elements such as work–life balance, productivity, work satisfaction, and job engagement (Juan, et al., 2021). People experience stress as they feel that they have lost control over whatever is happening to them in life. This leads to a change in their behaviour in

personal as well in their work life (Swaminathan, 2010). Employers today are critically analysing the stress management issues that contribute to lower job performance of employees. This results in dissatisfaction towards work and high turnover ultimately affecting organizational goals and objectives (Subha & Shakeel, 2009).

Remote Working has played a key role in reducing the spread of COVID-19. However, this mandatory and sudden shift to work from home has caught employees unprepared to adjust to the alteration. Contrary to working in the office, many employees have experienced significant difficulties due to overtime for dealing with household chores and childcare (Senturk, et al., 2021).

In the circumstances of lockdown and general remote work due to the pandemic, plus the constant presence of children or adults, it is foreseeable that household responsibilities would fall under women's duties who, in turn, would have to face double and triple burdens: taking care of the house, children's care and education, and work at the same time and place. (Juan, et al., 2021). Stress produces a state of physical and mental tension. There are a lot of stress management techniques that can be adopted to ward off stress in personal as well as work life. If the mind is relaxed, the muscles in the body will also be relaxed. It is recognised that yoga is a mind-body medicine, it helps to reduce stress and promotes health and wellness (Parshad, 2004).

## **Research Gaps**

The literature reviewed above focuses on various aspects of stress management. There is limited information available to understand the levels of stress faced by employees in remote working. The study focuses on understanding the levels and types of stress faced by employees and gender specific strategies used for coping with stress.

## **Research Objectives**

- To understand the perception of stress faced by employees in remote working
- To identify reasons for rising stress level and analyse coping mechanism of employees in remote working
- To suggest strategies to reduce stress and anxieties in remote working

## **Research Methodology**

The present study is partly exploratory, partly descriptive and partly causal. It is exploratory because it is concerned with identifying the existence and nonexistence of stress. It is descriptive as it aims to describe the various internal and external factors that contribute to stress. It is casual as it aims to analyse the causes for stress and the effect of stress in performance of the employees in remote working. This study is done on employees who have been Remote Working in Information Technology (IT) sector, Manufacturing, Pharmaceutical and Public Sector. Using Convenience Sampling 100 respondents comprising of 50 male and 50 female employees have been identified and administered Questionnaire through Google Forms.

Secondary sources of data have also contributed to the research. The data collected has been analysed using statistical tools to establish a relationship between gender and strategies of managing stress.

## **Results and Discussion**

The novel Coronavirus changed everything overnight, the lockdown was enforced, and social distancing became the new norm. People are staying connected with friends and family through video calls and schools have started giving online classes on video conferencing apps. With the lockdown in place, more than 3 billion people, excluding the essential workers like defence and healthcare officials, have been pushed to work from home.

The COVID-19 pandemic has led many IT companies around the globe to shut down their offices, causing millions of employees to work from home. The situation has provided an opportunity for the companies to experiment with remote work. Companies that have embraced the remote-working model are likely to continue to do so even after the pandemic ends. One of the India's largest IT companies, Tata Consultancy Services, for example, announced it was going to discard its 20-year-old work model and leapfrog into the new mode of work. Tata expects to have 75 percent of its 450, 000 employees work from home, up from the industry average of 20 percent, according to a Business Insider India article.

**Table 1. Demographic Profile of Respondents**

<b>Sl. No.</b>	<b>Particulars</b>	<b>No. of Respondents</b>	<b>Percentage</b>
<b>1</b>	<b>Age</b>		
A	20-30 Years	42	42%
B	31-40 Years	39	39%
C	41-50 Years	11	11%
D	51 & above	08	8%
	Total	100	100%
<b>2</b>	<b>Gender</b>		
a	Male	50	50
b	Female	50	50
	Total	100	100%
<b>3</b>	<b>Educational Qualification</b>		
a	Pre-University	15	15%
b	Undergraduate	46	46%
c	Post-Graduate	25	25%
d	Professional Courses	10	10%
e	Others	04	4%
	Total	100	100%
<b>4</b>	<b>Monthly Income</b>		
A	Less than 20, 000	13	13%
B	20, 000-30, 000	41	41%
C	30, 000-40, 000	37	37%
D	Above 40, 000	09	9%
	Total	100	100%

The table above presents the demographic composition of the respondents involved in the study. The sample is equal in gender representation, 50% of employees chosen are male and the remaining 50% are female. 42% of the respondents are under 30 years of age and only 8% are above 50 years of age. 46% of respondents chosen for study are undergraduates and average income of the respondents is in the bracket of 20, 000-40, 000 per month.

**Table 2. Work Profile of Respondents**

<b>Sl. No.</b>	<b>Particulars</b>	<b>No. of Respondents</b>	<b>Percentage</b>
<b>1</b>	<b>Area of Work</b>		
a	IT Sector	18	18%
b	Pharmaceutical Sector	09	9%
c	Public Sector	27	27%
d	Manufacturing Sector	14	14%
e	Others	32	32%
	Total	100	100%
<b>2</b>	<b>Work Experience</b>		
a	1-2 Years	21	21%
b	3-4 Years	35	35%
c	5-6 Years	22	22%
d	Above 7 Years	22	22%
	Total	100	100%
<b>3</b>	<b>Time spent in Remote Working</b>		
a	Less than 5 Hours	11	11%
b	5-6 Hours	35	35%
c	6-7 Hours	36	36%
d	Above 8 Hours	18	18%
	Total	100	100%
<b>4</b>	<b>Job Satisfaction Levels</b>		
a	Extremely Satisfied	10	10%
b	Satisfied	53	53%
c	Neutral	31	31%
d	Dissatisfied	05	5%
e	Extremely Dissatisfied	01	1%
	Total	100	100%
<b>5</b>	<b>Problems in Remote Working</b>		
a	Balancing between work life and family	15	15%
b	Communication & coordination challenges	26	26%
c	Distraction	39	39%
d	Social Isolation	06	6%
e	Network Issues	14	14%
	Total	100	100%

<b>6</b>	<b>Stress in Remote Working</b>		
a	Extremely High	23	23%
b	High	65	65%
c	Low	11	11%
d	Extremely Low	1	1%
	Total	100	100%

The table above presents the work profile of the 100 respondents who were part of the study. The study had a good representation of all the sectors involved and varied years of work experience starting of 2 years to 7 years. Majority of the respondents spent nearly 5-8 hours in remote working. When asked about the satisfaction level towards their present job, 53% of the respondents were satisfied. The most common problem in remote working as mentioned by respondents was coordination and more of distractions due to family members. Almost 80% of the respondents expressed that the stress levels in remote working were quite high.

**Table 3. Respondent's Opinion about Stress in Remote Working**

<b>Sl. No.</b>	<b>Statements</b>	<b>Strongly Agree</b>	<b>Agree</b>	<b>Neutral</b>	<b>Disagree</b>	<b>Strongly Disagree</b>
1	Long working hours is affecting their family life	17%	62%	16%	5%	Nil
2	Difficult to meet personal obligations every day in remote working	17%	68%	12%	3%	Nil
3	Employee's productivity is affected under stress	12%	63%	19%	6%	Nil
4	Long working hours is the reason for stress among employees	16%	62%	18%	4%	Nil
5	Female employees find more stressful to balance work and family life	20%	56%	26%	4%	Nil
6	Work from home is more stressful for women as compared	27%	52%	19%	2%	Nil

	to men					
7	Stress in remote working can lead to mental health problems, such as anxiety and depression	25%	49%	22%	3%	1%
8	Coping mechanism is important to combat stress from remote working.	28%	49%	20%	3%	Nil
9	Male employees have better skills in managing stress	25%	56%	15%	4%	Nil
10	Family support is essential in managing stress in remote working	22%	43%	29%	5%	1%
11	Stress coping mechanism of women is better than men	15%	62%	22%	1%	Nil
12	Employees prefer to continue remote working in future	8%	18%	25%	49%	Nil
13	Remote working must be discontinued to reduce stress	26%	44%	24%	5%	1%

The respondents were asked lot of questions to seek their opinion about remote working and how stressful it is. Majority of the respondents agreed that remote working was affecting their personal life and they were unable to meet their personal obligations. The respondents expressed their concern that long working hours was the primary reason for stress and this in turn affects their productivity at work. Majority of the respondents agreed that female employees face more stress in balancing work and family commitments in remote working. When asked whether men are more skilled in managing stress majority responded in the affirmative, however they felt that the coping mechanism of women was better than men. Majority of the respondents disagreed to the option of continuing work from home and suggested that it must be discontinued to reduce stress levels.

Respondents were facing both physical and mental health issues owing to stress in remote working. They had expectations that the organization must provide them orientation and counselling on management of stress. Bonus, Incentives and gifts for people employed in remote working could be beneficial to ward off stress.

Coping Mechanism to ward off stress levels can be categorized in three phases. The first phase would be to raise awareness about stress. An



individual must be able to identify when he / she is facing rising levels of stress, tipping the scales from positive to negative. This is important, as being able to identify signs of being stressed can help to take steps to ensure that your overall quality of life does not drop. Stress levels can be felt in any physical or psychological reactions, such as excessive sweating or heart palpitations, or the onset of headaches, irritability or the need to escape.

The second phase would be to identify the cause of stress. An individual must be able to analyse the situation and identify what is causing the rise in stress. These stressors can be external and internal. External stressors refer to things beyond your control, such as the environment or your colleagues at work. Internal stressors refer to your own thinking and attitude. Whilst it is not always possible to eradicate them, we can change the way that we cope with it.

The third phase would be to learn coping with stress. In order to deal with the situation that is causing stress, you must calm your mind and body so as to stave off the reactions and cope with it in a positive way. This can be through different methods, such as taking time off. If a situation is triggering your stress and you are unable to calm down, remove yourself from it. Alternatively, you can try implementing relaxation techniques such as deep breathing, meditation and yoga.

## **Conclusion**

Stress in Remote working has emerged as one of complex issues in people management. At workplace the responsibility of managing stress and maintaining work life balance falls on the shoulders of the HR Department. But in remote working, managing stress is totally the responsibility of employee. Organizations have the responsibility to have stress management strategies in place to help employees manage stress. Most organizations have employee engagement activities which act like a stress buster. Owing to the Covid-19 outbreak, all organizations had to resort to making their employees work from home. This led to a shift in the responsibility of maintaining a healthy and stress-free work environment from the employer to the employee. In remote working the employee is responsible for managing his work and stress that comes along his way. Levels of stress and way of managing stress depends on both gender as well as age of the individual. The use of effective coping skills can help in improving physical and mental well-being and enhance quality of life.

## References

1. Agata, O., 2013. Depression and ways of coping with stress: A preliminary study. *International Medical Journal of Experimental and Clinical Research*, Volume 19, pp. 1050-1056.
2. Emad, B. A. & Vikas, G., 2021. *Coping Mechanisms*. London: Stratpearls Publishing.
3. Juan, S., Idrovo, S. & Edison, J., 2021. Remote Work, Work Stress, and Work–Life during Pandemic Times: A Latin America Situation. *International Journal of Environmental Research and Public Health*, 2 July.18(13).
4. Keil, R. M., 2004. Coping and Stress: A Conceptual Analysis'. *Journal of Advanced Nursing*, 45(6), pp. 659-665.
5. Parshad, O., 2004. Role of Yoga in Stress Management. *The West Indian Medical Journal*, 1 June, 53(3), pp. 191-194.
6. Senturk, E., Genis, B. & Sagaltici, E., 2021. Predictors of Depression, Anxiety and Stress among remote workers during the COVID-19 Pandemic. *WORK: A Journal of Prevention, Assessment & Rehabilitation*, 28 September, 70(1), pp. 41-51.
7. Subha, I. & Shakeel, A., 2009. Impact of stress on Employee Productivity, Performance and Turnover: An Important Managerial Issue. *International Review of Business Research Papers*, January, 5(4), pp. 468-477.
8. Swaninathan, P. S., 2010. Study on stress levels in organizations and their impact on Employees' Behaviour. *Management and Labour studies*, February, 35(1), pp. 59-71.



Research Paper

## “Challenges of LIS Professionals as a Facilitators Of Information Resources In Social Networking Sites”

Gururaj F Duragannavar

Chief Librarian

Surana College, Kengeri Satellite Town  
Bangalore-560060

Shobha Dyamanagoudr

Asst. Librarian

Surana College, Kengeri Satellite Town  
Bangalore-560060

Latha

Research Scholar

Karnataka State Akkamahadevi Women's University  
Vijayapura-586101

---

### ABSTRACT:

Today in the age of information technology the library user or more techno savvy and need micro information about the subject. Social networking sites are one of the new technologies the opportunity to reach out to its clients in online and are the key to 21<sup>st</sup> century communication with library users, and enables libraries to pursue their mission and goal online, while promoting library resources and services. The paper describes the social networking sites in library affairs. Now a days everyone is connected with each other by means of various social networks like Face book, You tube, Twitter, Instagram, LinkedIn, pinterrest etc. These became an effective medium to share theknowledge and skills of the users and library professionals. Social networking sites will facilitate collaborations and promote effective communication between Librarians and their patrons. SNS's will help Libraries to keep pace with technologies and complete effective with the developed World. Social networking helps librarian to share information with patrons and students in the easiest way for digital library environment. Librarian can use in three broad activities in library and information services. The major three Information communication, knowledge distribution and Knowledge organization.

**KEYWORDS:** social Networking, SNS, Library Information Communication, knowledge distribution

Received 03 November, 2021; Revised: 15 November, 2021; Accepted 17 November, 2021 © The author(s) 2021. Published with open access at [www.questjournals.org](http://www.questjournals.org)

### I. INTRODUCTION:

From stone table to digital table, the history of libraries is a fascinating exploration of culture, politics, and society around the world today, The primary Function of any library is to acquire, store and disseminate the information, Social networking sites differentiates from traditional/ industrial media in many aspects such as quality, reach frequency, usability, immediacy and permanence the user attitude towards library is changing day-by-day, user wants most practical and speed information in e-learning age. But providing quick and easy retrieval information to user is great challenge to library professionals so the libraries initiated using social networking tools as it explores the information variously all content types like text, picture, video, audio material for members of the website and social media. Profiles on social network promote of library material and products, and services facilitate a more direct, active and efficient communication between libraries and their ever growing and ever more demanding user community. Social network sites provide speed and quick information to the information community by connecting and collecting digital information required by the

users. Face book is key example of social network site with over Worldwide; there are over 1.86 billion monthly active face book users (Facebook MAUs)which is a 17 percent increase year over year.

#### **DEFINITION OF SOCIAL NETWORKING SITE:**

According to Computing dictionary (2011), Social networking site as any website designed to allow multiple users to publish content of themselves. The information may be on any subject and may be for consumption by friends, mates, employers, just to mention a few. Quant Cast (2007b) define “Social networking sites are a type of virtual community that has grown tremendously in popularity over the past few years. The social networking site MySpace ranks sixth in overall web traffic, with 47 million unique US visitors each month. Boyd and Ellison (2007) define “social networking sites as web-based services that allow individuals to construct a public or semi-public profile within a bound system, articulate a list of other users with whom they share a connection, to view and navigate their list of connections and those made by others within the system”.

#### **OBJECTIVES OF SOCIAL MEDIA NETWORK SITES:**

- ❖ To promote resources/collections at the library
- ❖ To promote library services
- ❖ To modernize library Image and E-reputation
- ❖ To promote new acquisitions
- ❖ To connect with distance learners
- ❖ To connect with potential students
- ❖ To provide quick updates to users
- ❖ As research tool to locate official documents and studies
- ❖ To connect with wider community beyond the university e.g: the town in which the institution is based
- ❖ To engage with the academic community
- ❖ To send brief updates to patrons
- ❖ Marketing of library Products and Services
- ❖ To build Discussion groups and collaborative work
- ❖ To highlight subject specific information

#### **SOCIAL NETWORKING SITES USED BY LIBRARIES:**

Social networking sites are web-based services that allow individuals to construct a public or semi-public profile within a bounded system. Social networking sites allow librarians to adopt a new role by placing themselves into a social realm with users. By reading blogs, group postings, and message boards, the librarian becomes an active participant, who is able to anticipate and advise patrons as needs arise. Linking to patron profiles also keeps the library within the consciousness of users.

#### **Face Book:**

This is the biggest social media network on the Internet, both in terms of total number of users and name recognition. Most popular now because it is librarian -friendly, with many applications like JSTOR search, World Cat, and much more. Librarians can interact with users to know their information need. Libraries Try to link some of these specialized library applications to face book.

#### **YouTube:**

YouTube- the largest and popular video -based social media website One of the possible uses for YouTube is a storehouse for instructional videos with a link that could take the viewer to the library’s web site for more information in institutions in Nigeria, events such as important highlights of inaugural lectures, conferences and workshops are disseminated via the YouTube.

#### **Twitter:**

A microblogging application, to keep staff and patrons updated on daily activities, like frequently updated collections. Users can utilize this platform to type short message or status updated.

#### **Instagram:**

Instagram is a visual social media platform and it is a vary mobile photo sharing app that’s currently being used by over 80 million users. Instagram allows you to put all sorts of filters and effects on images and then share them with your network the library professionals are using Instagram to world Show Off their collections of Books, Show Off library Events and services, Show the librarians in their natural Habit, Show Off Library space.

**LinkedIn:**

Librarians can get patrons connected with specialists in their Particular field of interest via LinkedIn. Librarians can use this platform to render specialized services such as Strategic Dissemination(SDI).

**Pinterest:**

Pinterest is a web and mobile application company that operates a photo sharing website library are sharing ideas and information through the site as well, connecting with people from around the country and around the globe Many librarians are capitalizing on the visual power of Pinterest to show off book covers, especially those from new books, special collections, and kid-friendly material. It can be a great way to attract readers to books they might not have otherwise checked out. Libraries aren't just connecting with patrons; they're also using Pinterest to connect to other libraries.

**Teacher Tube:**

Teacher Tube, which is a YouTube for teacher, Presents an excellent opportunity for instructor- librarian collaboration. Instructors can guide students to helpful library resources, and vice versa.

**Wikipedia:**

Wikipedia is an online encyclopedia updated by users. You can use this tool to share your knowledge by editing, or simply point library patrons in the right direction. You can also host your library websites on wiki software like PB Wiki.

**Slide Share:**

Encourage faculty, staff, and students to share their slideshow Presentations for the greater community to access on Slide share. It's a great way to disseminate information among research community to the field of research and development (R&D) activities.

**WhatsApp:**

WhatsApp Messenger is a cross-platform instant messaging client for smartphones, PCs and tablets. It is a direct and user-friendly service for Library users to use Wats app to contact librarians, so as to locate general Library information and seek assistance when using the Library.

**Blogs:**

Here, librarians can periodically post messages; share information on a particular subject or issue, and allow users to contribute to content. They can write articles, news on topical issues and expect an instant reaction from their users.

**Wikis:**

Wikis is a free online encyclopedia that give a background knowledge and definition of concepts. It offers a platform for users to access, edit and contribute to content. This is a collaborative web page for developing web content.

**Library thing:**

A tool that enriches the library OPAC. Once an account is created, a list of books with ISBNs is sent to Library Thing which sends back a piece of code pasted into the footer the Library OPAC. Librarians can utilize this to send a list of current publications to users.

**Flicker:**

Librarians can use this tool to share and distribute new images of library collections. Cover page of new arrivals of both books and journals can be disseminated to users via Flicker. It can also be used to enlighten users on topical issues such as the different pictures of newly accessed books Academic libraries put this to great use.

**Digg:**

Digg is a great way to find useful content that you wouldn't come across in traditional ways. Find stories here, then share them with others using Digg's blog function.

**BENEFITS OF SOCIAL NETWORKING SITE SERVICES:**

- It promotes library services and disseminates news quickly, delivering this information more directly to library users;
- It increases engagement and interactions with library users;
- It enhances communication both within the library and with other departments;

- It can be used for outreach activities through onward sharing, well beyond the institution itself, helping build connections and reputation more broadly.
- Social networking sites will facilitate collaborations and promote effective communication between Librarians and their patrons.
- It will generate a flow of information excluded from search engines and library Catalogues...
- The crucial aim of librarians is to make library resources available to patrons so if social networking sites will help achieve this goal then it should be pursued vigorously.
- Social networking sites wall linked to a library’s web page has the potential of reaping great results by attracting and serving Distance Education Students. Et.al. (2002) stress that is through social networking sites that any person is capable of communicating and delivering a message to a distant target person.
- It will help Librarians and Libraries to keep pace with technologies and compete effectively with the developed World. (Ayiah and Kumah,2011).

#### **CHALLENGES OF USING SOCIAL NETWORKING SITES IN LIBRARIES:**

- ❖ Social media can require considerable time commitment from library staff.
- ❖ Social media can require technological expertise, for example customizing applications to provide access to online catalogs;
- ❖ It can be a challenge for librarians to use an informal but presentable tone, or deliver social media content in a bilingual or multilingual region;
- ❖ Levels of interest in and skills with using social media vary enormously across library staff;
- ❖ There are limited funds to support more advanced social media usage/features and the training that would be required to enable this;
- ❖ A library needs to work hard to maintain engagement with library users and attract popularity (followers, likes and so on);
- ❖ It can be difficult to maintain library branding for content/resources made accessible via social media;
- ❖ There are potential copyright issue when using social media such as YouTube to build collections;
- ❖ External factors such as Internet connectivity, technological infrastructure and government restrictions on the use of social media may restrict access.

## **II. CONCLUSION:**

As the access to Internet connectivity and computers are increasing day by day. In this century no one is interested in printed work. For librarians to make libraries interesting innovations such as social networking site should be introduced to attract them to the library environment. The number of libraries which adopt SNSs is increasing to explore the respondent’s attitude towards the use of social networking sites of library resources and services. *Now a days everyone is connected with each other by means of various social networks like Face book, You tube, twitter, Instagram linkedIn, pintrest etc.* Social networking sites would help establish a cordial relationship between librarians and patrons this paper highlights the challenges of Social Networking sites Usage libraries, objects of Social networking sites Usage in libraries, examples of Social network sites; Social Networking sites Opportunities for Libraries, benefits of use of Social Networking Sites; Problems in Use of Social Networking Sites.

## **REFERENCES:**

- [1]. <https://en.wikipedia.org/wiki/Library>
- [2]. [file:///C:/Users/administrator/Desktop/ical-10 180 494 2 RV.pdf](file:///C:/Users/administrator/Desktop/ical-10%20180%20494%20RV.pdf)
- [3]. <http://eduscapes.com/history>
- [4]. <http://decodedpast.com/the-history-of-the-public-library/1955>
- [5]. <http://wwideals.illinois.edu/bitstream/handle/2142/6904/librarytrendsv25i1topt.pdf?sequence=1>
- [6]. <http://ed.wikipedia.org/wiki/Special:Library#History>
- [7]. <http://www.klibjlis.com/2.4.1.pdf>
- [8]. <http://whatis.techtarget.com/definition/social-media>
- [9]. [http://eprints.rclis.org/16844/1/Social %20networking%20in%20Library.pdf](http://eprints.rclis.org/16844/1/Social%20networking%20in%20Library.pdf)
- [10]. <http://econsultancy.com/blog/3527-what-is-social-media-here-are-34-definitions/>
- [11]. <http://www.ebizmba.com/articles/socialnetworking-websites>
- [12]. [http://www.google.co.in/search?q=teacher+tube+used+by+libraries&oq=teacher+tube+used+by+libraries&aqs=chrome..69i57.85j0j7&sourceid=chrome&ie=UTF-8](http://www.google.co.in/search?q=teacher+tube+used+by+libraries&oq=teacher+tube+used+by+libraries&aqs=chrome..69i57j85j0j7&sourceid=chrome&ie=UTF-8)

University of Nebraska - Lincoln

DigitalCommons@University of Nebraska - Lincoln

---

Library Philosophy and Practice (e-journal)

Libraries at University of Nebraska-Lincoln

---

2-15-2022

## Fifty Years (1970-2019) Journey of 'Journal of Documentation': A Scientometric Analysis of Research Productivity and Publication Trends

Gururaj F. Durgannavar Mr.

*Chief Librarian, Surana College, Kengeri Satellite Town, Bengaluru, Karnataka, INDIA,*  
fd.gururaj@gmail.com

Manoj Kumar Verma Dr.

*Associate Professor, Department of Library and Information Science, Mizoram University, Aizawl, Mizoram, INDIA, manojdlis@mzu.edu.in*

Sidhartha Sahoo Dr.

*Indian National Centre for Ocean Information Services, Hyderabad, Telangana, INDIA,*  
sidhartha@incois.gov.in

Ghouse Modin Nabeesab Mamdapur Mr.

*Scientist-Information and Documentation Synthite Industries Pvt. Ltd, Kolenchery, Ernakulam, Kerala, INDIA, ghouse@synthite.com*

Follow this and additional works at: <https://digitalcommons.unl.edu/libphilprac>



Part of the [Collection Development and Management Commons](#), [Scholarly Communication Commons](#), and the [Scholarly Publishing Commons](#)

---

Durgannavar, Gururaj F. Mr.; Verma, Manoj Kumar Dr.; Sahoo, Sidhartha Dr.; and Mamdapur, Ghouse Modin Nabeesab Mr., "Fifty Years (1970-2019) Journey of 'Journal of Documentation': A Scientometric Analysis of Research Productivity and Publication Trends" (2022). *Library Philosophy and Practice (e-journal)*. 6941.

<https://digitalcommons.unl.edu/libphilprac/6941>

# **Fifty Years (1970-2019) Journey of 'Journal of Documentation': A Scientometric Analysis of Research Productivity and Publication Trends**

**Mr. Gururaj F. Durgannavar<sup>1</sup>**

Chief Librarian,  
Surana College, Kengeri Satellite Town,  
Bengaluru, Karnataka, INDIA, E-Mail: [fd.gururaj@gmail.com](mailto:fd.gururaj@gmail.com)

**Dr. Manoj Kumar Verma<sup>2</sup>**

Associate Professor,  
Department of Library and Information Science, Mizoram University,  
Aizawl, Mizoram, INDIA, E-Mail: [manojdlis@mzu.edu.in](mailto:manojdlis@mzu.edu.in)

**Mr. Sidhartha Sahoo<sup>3</sup>**

Indian National Centre for Ocean Information Services,  
Hyderabad, Telangana, INDIA, E-Mail: [sidhartha@incois.gov.in](mailto:sidhartha@incois.gov.in)

**Mr. Ghouse Modin Nabeesab Mamdapur<sup>4\*</sup>**

Scientist-Information and Documentation  
Synthite Industries Pvt. Ltd, Kolenchery,  
Ernakulam, Kerala, INDIA, E-Mail: [ghouse@synthite.com](mailto:ghouse@synthite.com)

## **STRUCTURED ABSTRACT**

### **Purpose**

In this study, we conducted quantitative analysis of 1706 scholarly literature published in *Journal of Documentation* during the period of 1970 to 2019 (fifty years) using a series of scientometric indicators. Annual scientific production, most local cited sources, the ranking of authors; profiles, contributions, correlation, collaboration and authorship pattern, most contributed countries, most cited articles, frequently used search terms/keywords, and the legend of historiographic mapping were analysed in detail to measure the impact of the source.

### **Design/methodology/approach**

We used the Scopus database for retrieving the desired sample data. In total, 1,706 numbers of publications records were considered for the literature analysis considering their relevancy. Biblioshiny data visualization tool is used to create the various maps.

### **Findings**

The present study found that annual scientific production and average citations constantly have had an uptrend. The journal's had tremendous impact with an h-index of 80, with a g-index of 148, total citations of 37,161 within the studied period. Although Bawden D contributed the highest number of research papers (n=78), the work published by Hjørland B received the highest citations. Lotka's Law reveals that about 75.04% of the authors (1319 authors) have one publication, and approximately 12.73% of the authors (225 authors) have two publications. The United Kingdom was the dominant country in terms of number of papers and citation count whereas University of Sheffield topped with 128 publications. The thematic map consists of eleven clusters and 'information retrieval' found to be the largest cluster comprehending 56 subthemes occurring 995 times. Co-citation network identified four clusters with revealing Wilson TD as the most cited authors. The study also indicates the most collaborative authors are from the United Kingdom.

### **Research limitations/implications**

The study exclusively deals with 1732 published research literature indexed in the Scopus database covering a span of fifty years (from 1970 to 2019). Thus, documents which are not covered in Scopus are excluded from the purview of research. This study is significant in order to measure the impact of *Journal of Documentation* and useful to identify valuable research patterns from publications and developments in the field of Information Science.

**Keywords:** *Scientometrics; Collaboration; Co-network; Trend analysis; Scopus; Biblioshiny.*



## INTRODUCTION

The era of information and knowledge society has witnessed information overload and an explosion of data. Most of the research contributors, i.e., students, researchers, faculties, institutions, agencies, and departments, produce qualitative and quantitative research outcomes in applied, conceptual, theoretical, practical, empirical and analytical types of research in every discipline or subject. In the changing world, information seekers seek accurate, reliable and timely information for their academic needs. Thus, the information generator, aggregators, service providers and information agents of library professional are needed to analyze the productivity of research publication with using different information or content analysis metrics formulas, tools and techniques which were already initiated by information experts like the Alfred J. Lotka (1926), Ranganathan, S.R. (1930), Bradford (1934), Derek John de Solla Price (1961), Pritchard & Nalimov and Mulchenko (1969) and others, they have formulated different metrics for analysis of information or research productivity, i.e., altmetrics, bibliometric, biometrics, cybermetric, econometrics, educametrics, informetrics, librametry, psychometrics, scientometric, sociometrics, Technometrics, and webometric, etc., metrics were formulated to analyze and evaluate qualitative and quantitative research production irrespective all subjects. Therefore, the 21<sup>st</sup> century might be called the 'century of development of metric sciences' (Dutta, 2014).

In the present study, the bibliometric and Scientometric metric tools were used to analyse the research works published in the *Journal of Documentation* in the last five decades (from 1970 to 2019). Both the bibliometric and Scientometric tools were used to analyse the most contributing authors, author's affiliations, institutions/universities, most contributed countries and impact factors. Most-cited papers & citing articles, nature of citation, co-citation, co-authorship and co-occurrence of keywords and the Scopus, Web of Science, Google Scholar, journal archives/back issues and other scholarly databases have become essential sources to collect critical data for research studies. Bibliometric and Scientometric tools were used for further literature analysis. Some of the essential Bibliometric and Scientometric parameters applied in this study are mentioned as below:

- **Laws of bibliometrics:** Lotka's law of scientific production, Bradford's law of scattering contents, and Zipf's law of word count are commonly used in bibliometrics.
- **Co-citation coupling:** used to indicate a subject similarity between the two document publications.
- **Bibliographic coupling:** it operates on a similarity principle; it links two publications cited in the same publications.
- **Web application of bibliometric:** a new developing area in bibliometrics has emerged in webometrics/cyber metrics to study the relationship between the different sites on the WWW.
- **Citation analysis:** It is established to study the relationship between the authors and their produced research works.

Recently an American Physicist, Hirsch Jorge E proposed a new metric indicator for measuring the individual bibliometric community's research performance. The h-index is on both publication activity and citation impact. It has immediately found interest in the public and received positive reception in the physics community and in Scientometric literature (Hirsch, 2005). After several modifications, adjustments, improvements and developments on various literature metrics, methods and tools have been proposed by bibliometricians to change bibliometric methods, tools and applications towards micro-level and tools to Web resulted in the emergence of a new sub-discipline called Webometrics. Scientometrics 2.0 now exists with an outlined framework for the revised version of scientometrics (Priem & Hemminger, 2010). Ingwersen, Peter, Isidro, Aguillo, Thelwall Mike, Bar-Ilan, Judit,

Vaughan, Liwen and others are eminent personalities who proposed developed concepts in the field of bibliometrics and scientometrics.

## **JOURNAL PROFILE**

*Journal of Documentation* is a double-blind peer-reviewed leading academic quarterly (1945-1996) journal but during 1997 to 1999, five issues were published each year. In the academic year 2000 onwards, it published articles on a bimonthly basis. All research contributions are published in the English language only. The journal is published by Emerald Group of Publishing, and David Bawden is present editor-in-chief of the journal. The journal covered and focused on new theories, concepts, models, framework, inventory practices and philosophical scholarly articles, documents, working papers, reports, reviews and critic works and record knowledge with novel methods or results of broad significance, in all information related subject disciplines such as pure science, science, social science, physical science, commerce & management, science & technology, education, communication media, psychology and cognitive science and other allied subjective research studies has been published in *Journal of Documentation*. The journal extensively covers articles on information sciences, incorporating all scholarly and professional disciplines that deal with recorded information. It also provides a link between research, scholarship and reflective professional practices and experiences. Authors need to submit their research contribution in word format only. Research works record words between 4000 to 10000, the author name, affiliation, and e-mail addresses were made mandatory for the submitter. The journal's primary audience and contributors are students, research scholars, teachers-educators, scientists, research associates, research project fellows and planners, and policymakers in respective disciplines. The submitting papers need to follow the article frame's outline, which includes structured abstract, the purpose of study, design/methodology/Approach, findings and originality of research work, limitation, practical implications, and social implications. It has an impact factor of 2.6 for 2020 and is indexed in many more databases like Scopus and Emerald databases. [Source: <https://www.emerald.com/> Accessed on 6<sup>th</sup> December 2021).

## **REVIEW OF LITERATURE**

In recent years, with the enormous growth of scholarly literature in all fields, there have been several bibliometric/scientometric studies conducted to assess, analyze and evaluate the research productivity in different subject disciplines such as pure science, life science, social science, physical science, commerce & management, science & technology, education, health science and other allied subjects. In this section, authors consulted many full-text, indexing, citation and archival databases, then searched, browsed and retrieved some good number of relevant articles, books, reports, review and critics works which were reviewed and presented in this study. (Martinez Lopez et al., 2018) investigated the research productivity of the *European Journal of Marketing* found that the British authors and institutions are ranked as the most contributor in the journal. (Sigifredo et al., 2018) conducted a bibliometric analysis of the *journal of optimization theory and applications (JOTA)*, and demonstrated the impact it made on the domain of mathematics, science and engineering. A similar study was conducted to investigate the research performance of the journal 'Information Science' and significant growth of journal contributions from developed and under-developing countries are visualised (Merigó et al., 2018). (Modak et al., 2019) analyzed the research publications of *Transformation Research Journal (TRJ)* and indicated the multidimensional focus of economic, engineering, social science research. Dominance of multiple-authorship was observed in this study. (Milfont et al., 2019) analysed research productivity of '*Environment and Behaviour*' obtaining data from Web of Science core collection found that Evana, Gary E identified as most research contributors, along with Stern, Paul C. and Dietz, Thomas. Further, the study revealed that significant numbers of publications were contributed by the University of Michigan research community.

Interestingly, there is an increasing trend in most women and international contributors to the journal. Another similarity study on research productivity bibliometric analysis of *IISE transactions* journal publications published between 1969 to 2018 was published (Shuang, 2019). The study evaluates that the significant contributions of the leading authors, institutions, countries, most cited articles and current trends in productivity of research outcomes issues were identified, and the VOSviewer software was used to visualize the collaboration relations, co-citation, citation, co-authorship, co-occurrence, journal co-citation network and co-occurrence of high-frequency. (Zou et al., 2020) analyzed the '*Accident analysis & prevention (AA&P)*' journal using multi-dimensional statistical and visualization tools. Analysis of results reported that yearly publication production of AA&P had grown exponentially. Further, the study provides emerging research fields of boom frequency and boom injury severity modelling analyses were identified. In total, 3710 number of research publications published in *British Journal of Education Technology (BJET)* during 1971 to 2018 were analyzed and citation trends, research hotspots, topic modelling are identified to have better understanding of publishing patterns (Chen et al., 2020). The bibliometric analysis of fifty years' research productivity of the '*Financial Review*' publications published between 1969 to 2018. focused on the impact factor of journal, hotspot research areas/research themes, most prolific researchers and their research affiliations, most contributed countries, cited articles and most frequently discussed themes were analyzed and identified (Kent Baker et al., 2020). Further, in their study, (Li et al., 2020) conducted bibliometric analysis of '*bottleneck model research*' research journal productivity in the last five decades from 1969 to 2018. The demand-side, supply-side, joint strategies and supply sides strategies were used to classify the literature. The study has identified that the most influential research papers, most contributed authors, countries and top-ranked research areas, research trends, and potential directions for future/further study issues were highlighted and discussed in this study. The studies reviewed above analysed the research productivity of different journal publications published in the last five decades. Most of the studies used Scopus and Web of Science core collection databases to collect and analyse relevant data. It is identified that all studies were analysed on the basis of the parameters namely the most contributing authors and their affiliations, institutions/universities, most contributed countries, most cited papers and citing articles and graphical analysis of coupling, citation, co-citation, co-authorship and co-occurrence of keywords.

## **OBJECTIVES OF THE STUDY**

The main objectives of the study are:

- To conduct a Scientometric assessment of *Journal of Documentation* during the period of (1970-2019)
- To analyze year-wise Growth of publications and average citations
- To find most relevant authors, most cited authors and top authors production over time
- To find most relevant affiliations, country-wise scientific production and most cited countries.
- To find most global cited documents, most local cited documents and Reference spectroscopy
- To evaluate the frequency distribution of scientific productivity by Lotka's law
- To assess WordCloud, TreeMap, Word Dynamics and Trend Topics in author keywords

## **METHODOLOGY**

Scientometrics parameters were used in the present context of the study. The study period was restricted to the years 1970 to 2019. The study is based on the *Journal of Documentation* publications indexed by the Scopus database. The research data was retrieved from the Scopus citation database (<http://www.scopus.com/search/>) using search string SRCTITLE (journal AND of AND Documentation) AND DOCTYPE (ar OR re) AND PUBYEAR >1969 AND PUBYEAR <2020 AND (LIMIT-TO (EXACTSRCTITLE, "*Journal of Documentation*")) AND (LIMIT-TO (LANGUAGE,

"English")) on 2<sup>nd</sup> January 2021. The search strategy generated 1706 records, which was used for further analysis. Only the articles and review articles were the type of the publications selected for the analysis. The complete bibliographic data was retrieved from the Scopus database in comma-separated values file is a delimited text file (.csv) file format. Initially, the bibliometrix R package (Version Rx 64 4.0.3 released on 12-06-2020) was installed and Opened in Rstudio and then, in the console window, digit: install packages ("bibliometrix") enter the command to install the bibliometrix stable version from CRAN. Then, the biblioshiny app was started by entering the string digit 'biblioshiny' in the R console. The biblioshiny: The shiny app for bibliometrix from R Statistical Package (<https://bibliometrix.org/Biblioshiny.html>) was used to carry out the present bibliometric analysis. The summary of bibliographic statistics for analysis depicted in Table 1.

**Table 1: Descriptive analysis: Main information regarding the Journal of Documentation**

Description	Results
<b>MAIN INFORMATION ABOUT DATA</b>	
Timespan	1970:2019
Sources ( <i>Journal of Documentation</i> )	1
Documents	1706
Average years from publication	18
Average citations per documents	21.78
Average citations per year per doc	1.317
References	60406
<b>DOCUMENT TYPES</b>	
Article	1033
Review	673
<b>DOCUMENT CONTENTS</b>	
Keywords Plus (ID)	217
Author's Keywords (DE)	2111
<b>AUTHORS</b>	
Authors	1759
Author Appearances	2936
Authors of single-authored documents	597
Authors of multi-authored documents	1162
<b>AUTHORS COLLABORATION</b>	
Single-authored documents	1010
Documents per Author	0.97
Authors per Document	1.03
Co-Authors per Documents	1.72
Collaboration Index	1.67

## DATA INTERPRETATION

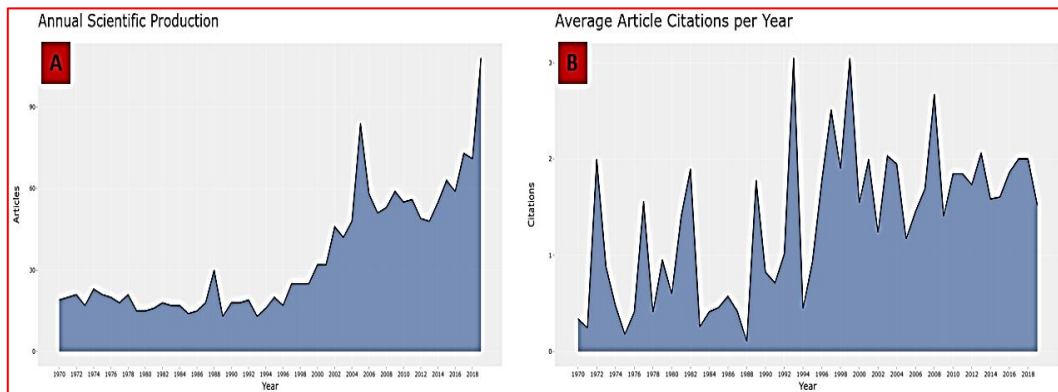
Table 2 and Fig. 1 (A & B) shows that annual scientific production and average citations during the fifty years of study in which articles initiated in 1970 and have had an uptrend till 2019, reaching 108 articles in 2019 and declining slightly in the year 1989 and 1993 with 13 articles followed by 1985 with 14 articles. The average article citations per year item peaked in around 1972 with 21 articles of 2013 citations, 2008 with 53 articles of 1700 citations and followed by 1999 with 25 articles of 1599 citations and an overall decline can be seen in 1988 with 30 articles of 104 citations and followed by 1983 with 17 articles. It can be seen from Fig. 1 (B) shows that rather than maintaining the same growth rate, the average citations per item in the field of land degradation experienced several fluctuations. Therefore, in this respect, the average citations per year of articles in the *Journal of Documentation* decreased and increased year by year with descending quality or influence. It

indicates that the *Journal of Documentation* research in Library Science has entered a tough period at this stage.

**Table 2: Year-wise distribution of articles and citations**

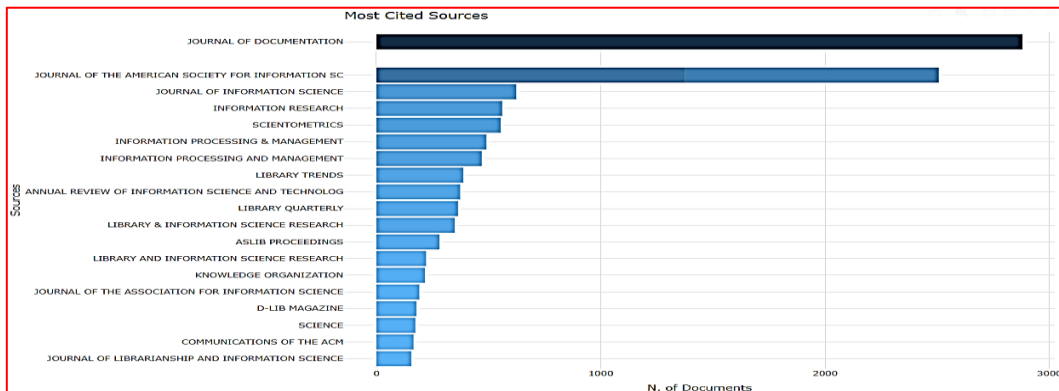
Year	No. Articles	TC	Mean TC per Article	Mean TC per Year	Citable Years
1970	19	324	17.05	0.34	50
1971	20	242	12.10	0.25	49
1972	21	2013	95.86	2.00	48
1973	17	703	41.35	0.88	47
1974	23	509	22.13	0.48	46
1975	21	171	8.14	0.18	45
1976	20	362	18.10	0.41	44
1977	18	1208	67.11	1.56	43
1978	21	362	17.24	0.41	42
1979	15	587	39.13	0.95	41
1980	15	361	24.07	0.60	40
1981	16	876	54.75	1.40	39
1982	18	1297	72.06	1.90	38
1983	17	163	9.59	0.26	37
1984	17	254	14.94	0.42	36
1985	14	225	16.07	0.46	35
1986	15	293	19.53	0.57	34
1987	18	249	13.83	0.42	33
1988	30	104	3.47	0.11	32
1989	13	717	55.15	1.78	31
1990	18	447	24.83	0.83	30
1991	18	372	20.67	0.71	29
1992	19	539	28.37	1.01	28
1993	13	1070	82.31	3.05	27
1994	16	187	11.69	0.45	26
1995	20	467	23.35	0.93	25
1996	17	724	42.59	1.77	24
1997	25	1444	57.76	2.51	23
1998	25	1046	41.84	1.90	22
1999	25	1599	63.96	3.05	21
2000	32	989	30.91	1.55	20
2001	32	1214	37.94	2.00	19
2002	46	1026	22.30	1.24	18
2003	42	1452	34.57	2.03	17
2004	48	1496	31.17	1.95	16
2005	84	1476	17.57	1.17	15
2006	58	1183	20.40	1.46	14
2007	51	1121	21.98	1.69	13
2008	53	1700	32.08	2.67	12
2009	59	913	15.47	1.41	11
2010	55	1016	18.47	1.85	10
2011	56	931	16.63	1.85	9
2012	49	680	13.88	1.73	8
2013	48	694	14.46	2.07	7
2014	55	523	9.51	1.58	6
2015	63	506	8.03	1.61	5
2016	59	439	7.44	1.86	4
2017	73	439	6.01	2.00	3

2018	71	284	4.00	2.00	2
2019	108	164	1.52	1.52	1



**Fig. 1:** A – Annual Scientific Production; B – Average Article Citations per Year

The most top twenty local cited sources (from Reference lists) in Fig. 2. This shows sources of journals included in at least one of the article's reference lists set from 1970-2019 in *Journal of Documentation*. The top-cited journals are *Journal of Documentation* with 2880 citations, *Journal of the American Society for Information Science and Technology* with 2507 citations, *Journal of Information Science* with 624 citations, *Information Research* with 561 and *Scientometrics* with 555 citations had more than 500 citations.



**Fig. 2:** Most Local Cited Sources in *Journal of Documentation* from (1970-2019)

### Source local impact

A source of the *Journal of Documentation* in Table 3 shows the journal's impact with an h-index of 80, with a g-index of 148, having total citations of 37,161 with 1706 for the period of fifty years from 1970-2019.

**Table 3: Source local impact**

Source	h-index	g-index	m-index	TC	NP	Per Year start
<i>Journal of Documentation</i>	80	148	1.569	37161	1706	1971

\*(TC: Total Citations; NP: Number of Publication)

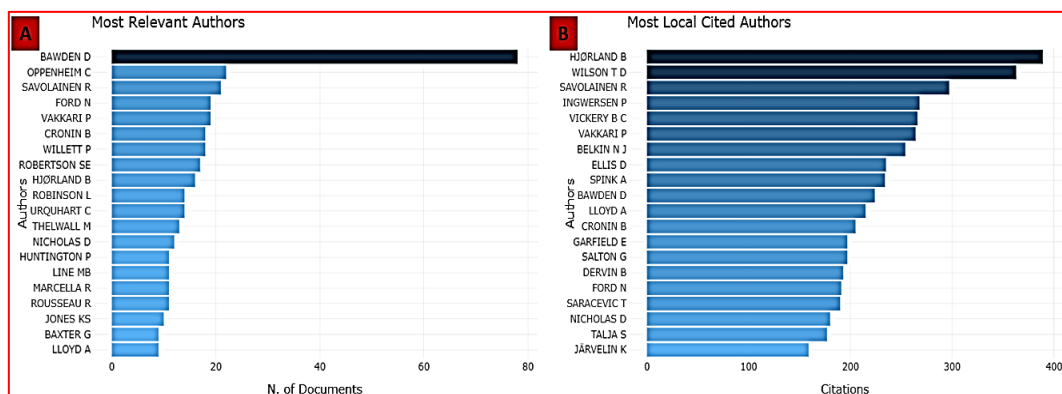
### Most Productive authors in the *Journal of Documentation*

Results found from the Table 4 and Fig. 3 (A & B) reveals that highest 78 research most relevant research articles with 76.00 fractionalized by the Authors Bawden D., but his works citation rank goes down to 10th ranking, in other hand the Hjørland B. have published only 16 relevant articles, but his works were highly cited with 389 times. Further, the author Oppenheim, C. and Savolainen R., are respectively published 22 (fractionalized per cent is 14.50) and 21 (fractionalized per cent is 17.25)

most relevant articles and the Sovolainen works citation rank is 3rd and no citations are not found for Oppenheim relevant works. Also, the table found that 19, 18, 14 and 11 number of most relevant articles were equally contributed by the authors, i.e., Ford, Vakkari, Cronin, Willett, Rebertaon, Urquhart, Huntington, Line, Marcella and Reusseau followed by Ford N and Vekkari relevant 19 cited works got 16th and 6th ranked in most local cited author and the authors, i.e., Rebertaon, Urquhart, Huntington, Line, Marcella and Reusseau works were cited by local research community.

**Table 4: Prolific of Most relevant authors and most local cited authors**

Top 20 Most Relevant Authors				Top 20 Most Local Cited Authors		
Rank	Authors	Articles	Articles Fractionalized	Rank	Authors	Citations
1	Bawden D	78	76.00	1	Hjørland B	389
2	Oppenheim C	22	14.50	2	Wilson TD	363
3	Savolainen R	21	17.25	3	Savolainen R	297
4	Ford N	19	9.52	4	Ingwersen P	268
5	Vakkari P	19	9.51	5	Vickery BC	266
6	Cronin B	18	11.83	6	Vakkari P	264
7	Willett P	18	7.44	7	BelkinNJ	254
8	Robertson SE	17	11.50	8	Ellis D	235
9	Hjørland B	16	13.17	9	Spink A	234
10	Robinson L	14	8.50	10	Bawden D	224
11	Urquhart C	14	10.09	11	Lloyd A	215
12	Thelwall M	13	9.33	12	Cronin B	205
13	Nicholas D	12	3.88	13	Garfield E	197
14	Huntington P	11	2.88	14	Salton G	197
15	Line MB	11	10.00	15	Dervin B	193
16	Marcella R	11	6.58	16	Ford N	191
17	Rousseau R	11	6.92	17	Saracevic T	190
18	Jones KS	10	9.00	18	Nicholas D	180
19	Baxter G	9	4.58	19	Talja S	177
20	Lloyd A	9	7.42	20	Järvelin K	159



**Fig. 3: (A)-Top 20 Most relevant authors and (B)-Top 20 most local cited authors**

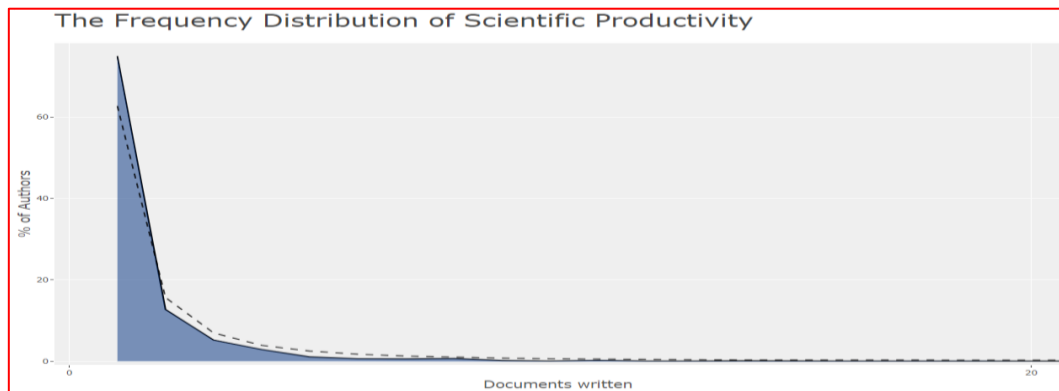
### Author Productivity through Lotka's Law

Lotka's law of scientific productivity has been applied to the collected dataset and the results are indicated in Table 5. A total of 1759 authors published articles between the fifty years of 1970-2019. Fig.4 depicts Lotka's Law, which computes the frequency distribution of scientific productivity. Here, Lotka's Law reveals that about 75.04% of the authors (1319 authors) have one publication, and

approximately 12.73% of the authors (225 authors) have two publications. There are outliers, with very few authors with more than nine publications.

**Table 5: Frequency distribution of scientific productivity applied by Lotka's Law**

Articles written	No. of Authors	The proportion of Authors (%)
1	1319	75.04
2	225	12.73
3	92	5.23
4	51	2.90
5	19	1.08
6	11	0.63
7	10	0.57
8	12	0.68
9	3	0.17
10	1	0.06
11	4	0.23
12	1	0.06
13	1	0.06
14	2	0.11
16	1	0.06
17	1	0.06
18	2	0.11
19	2	0.11
21	1	0.06
22	1	0.06



**Fig. 4:** Frequency distribution of scientific productivity shown through Lotka's Law

### Top Twenty Prolific Authors

Table 6 lists the top 20 authors with the highest impact by H-index and lists the most relevant authors based on the number of articles they published. The Hirsh index generally referred to as H-index, indicates the minimum number of times an author or a journal has been cited. Cronin B has by far the highest 14 H-index and 18 number of articles with 630 citations followed by Ford N. the second place 13 H-index and 19 number of articles with 638 citations and Oppenheim C & Willett P ranked in the top 3 for both authors with the 12 H-index and (19 and 22) articles with (588 and 418) citations each. This suggests that these authors are the most productive authors with active and frequent publication in the *Journal of Documentation* for 1970-2019.



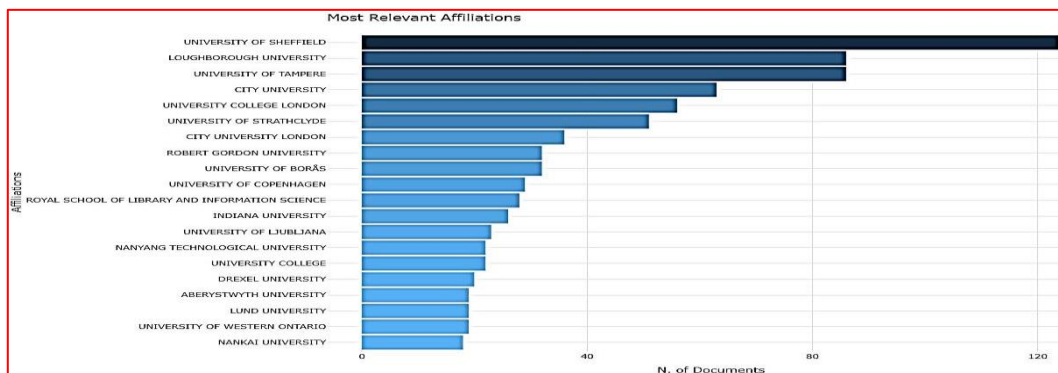
**Table 6: Top Twenty Prolific Authors engaged in Journal of Documentation**

Authors	h-index	g-index	m-index	TC	NP	Per Year start
Cronin B	14	18	0.350	630	18	1981
Ford N	13	19	0.317	638	19	1980
Oppenheim C	12	22	0.279	588	22	1978
Willett P	12	18	0.286	418	18	1979
Hjørland B	11	16	0.478	791	16	1998
Thelwall M	11	13	0.524	428	13	2000
Savolainen R	10	21	0.435	454	21	1998
Robertson SE	10	17	0.204	969	17	1972
Nicholas D	10	12	0.400	374	12	1996
Huntington P	10	11	0.526	357	11	2002
Vakkari P	9	19	0.375	568	19	1997
Rousseau R	9	11	0.265	182	11	1987
Robinson L	8	14	0.471	200	14	2004
Jones KS	8	10	0.157	2132	10	1970
Lloyd A	7	9	0.467	537	9	2006
Bawden D	6	22	0.240	527	78	1996
Line MB	6	11	0.118	276	11	1970
Marcella R	6	9	0.273	95	11	1999
Urquhart C	5	9	0.217	83	14	1998
Baxter G	5	8	0.227	72	9	1999

\* (TC: Total Citations; NP: Number of Publication)

**Most Relevant Affiliations**

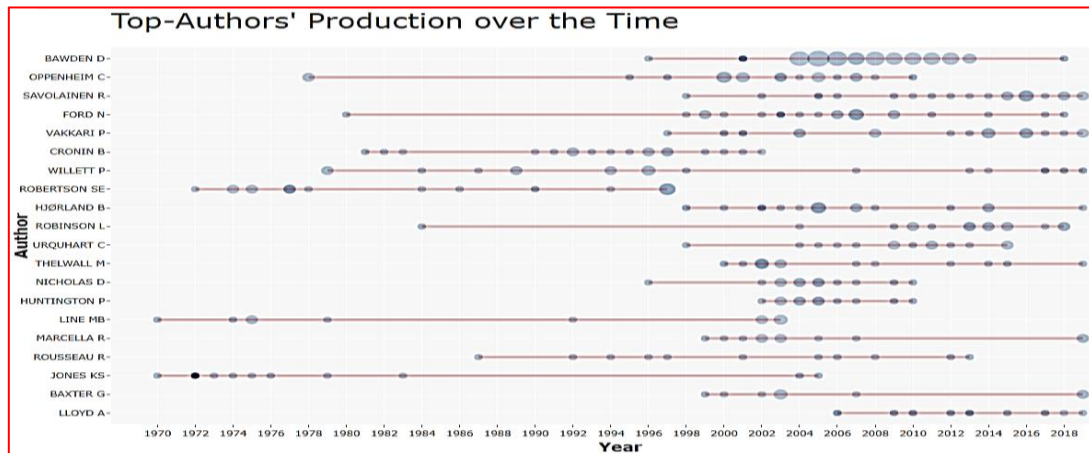
Fig. 5 displays the top 20 relevant affiliations from which *Journal of Documentation* publications has been carried out. The United Kingdom was the dominant country in terms of number of papers and citation count, University of Sheffield situated in Sheffield has topped the list with maximum 128 publications followed by Loughborough University and University of Tampere with 86 publications each. The University of Strathclyde and Robert Gordon University from Scotland contributing 52 and 34 publications each, followed by University of Copenhagen and Royal School of Library and Information Science from Denmark contributing 28 and 29 publications each. It is interesting to see that seven institutions out of top 20 are from the United Kingdom that sand 2 institutes each are from Scotland, Sweden, Denmark and China respectively.



**Fig. 5: Top 20 most relevant affiliations**

### Top-Authors' Production over the time

Fig. 6 shows the top twenty authors production (in terms of several publications, and total citations per year) of articles have published over a period, with the most elevated number of the article during the years, and how many citations each one article have retrieved (Gilani et al., 2019). Each circle's size demonstrates the quantity of articles and quantifies its intensity of the circles, which shows the number of citations of the author production over a time graph.



**Fig. 6:** Top twenty Author's production over time

### Prolific of Most Corresponding Author's Country and most cited countries

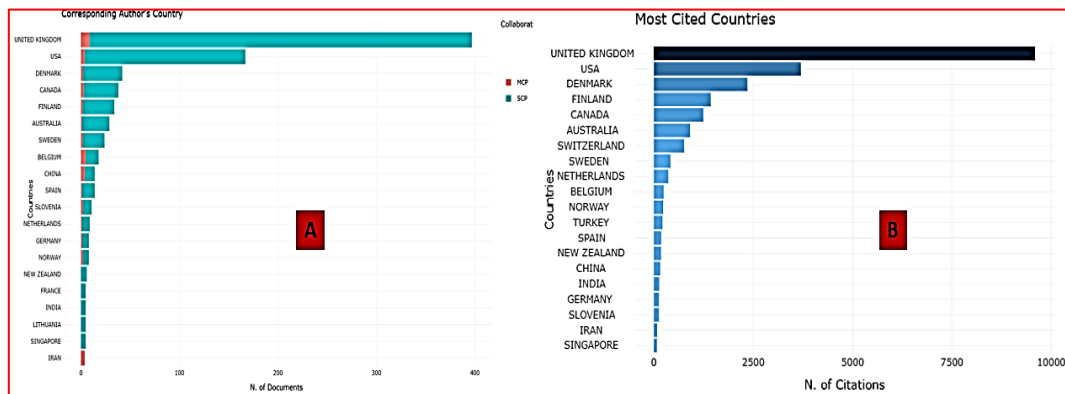
Table 7 and Fig. 7 (A & B) show the number of articles produced by the authors of different countries and each country's authors' co-operation rate with other countries' authors. For instance, authors of the United Kingdom have produced 397 articles, but authorship co-authorship with other countries' authors is about 10%. Subsequently, the UK authors ranked second with 62 papers, and the authorship rate for contributing articles to other authors with other countries is 27.4%. The total number of citations referenced to articles and the average citation of articles produced by each country's authors. For example, researchers from the United Kingdom have published 9,598 citations, followed by the USA with 3,702 citations and Denmark with 2,355 citations. The average article citation was published by researchers in Switzerland and Turkey (765 citations with ACC 255 and 219 citations with ACC 73) (Jho, 2018).

**Table 7: Prolific of Most Corresponding Author's Country and most cited countries**

Corresponding Author's Country						Most Cited Countries		
Country	Articles	Freq.	SCP	MCP	MCP Ratio	Country	TC	AAC
UK	397	0.44	388	9	0.02	UK	9598	24.18
USA	167	0.19	163	4	0.02	USA	3702	22.17
Denmark	42	0.05	40	2	0.05	Denmark	2355	56.07
Canada	38	0.04	35	3	0.08	Finland	1431	42.09
Finland	34	0.04	32	2	0.06	Canada	1246	32.79
Australia	29	0.03	28	1	0.04	Australia	915	31.55
Sweden	24	0.03	22	2	0.08	Switzerland	765	255.00
Belgium	18	0.02	13	5	0.28	Sweden	422	17.58
China	14	0.02	10	4	0.29	Netherlands	364	40.44
Spain	14	0.02	13	1	0.07	Belgium	249	13.83
Slovenia	11	0.01	9	2	0.18	Norway	237	29.62
Netherlands	9	0.01	8	1	0.11	Turkey	219	73.00
Germany	8	0.01	7	1	0.13	Spain	189	13.50

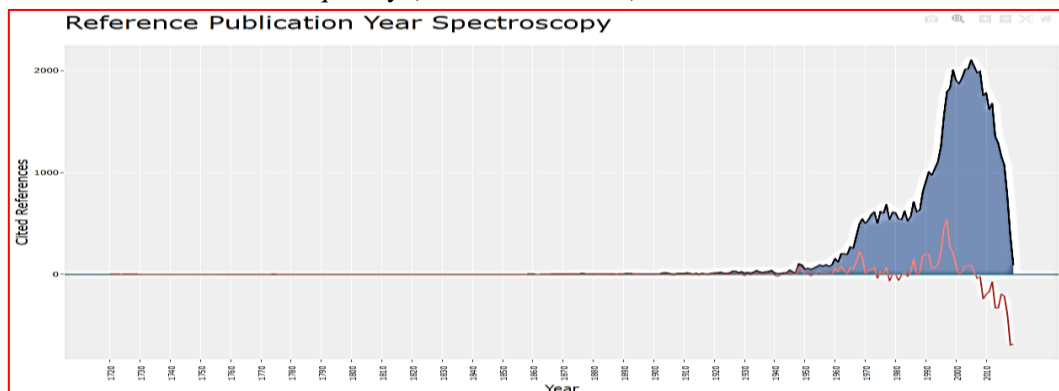
Norway	8	0.01	6	2	0.25	New Zealand	182	30.33
New Zealand	6	0.01	6	0	0.00	China	163	11.64
France	5	0.01	5	0	0.00	India	135	27.00
India	5	0.01	5	0	0.00	Germany	129	16.12
Lithuania	5	0.01	5	0	0.00	Slovenia	129	11.73
Singapore	5	0.01	5	0	0.00	Iran	82	20.50
Iran	4	0.00	0	4	1.00	Singapore	76	15.20

\*(SCP: Single Country Publication; MCP: Multiple Country Publication; TC: Total Citations; AAC: Average Article Citation)



**Fig. 7:** (A)-Top 20 Corresponding Authors Country and (B)-Most Cited Countries

Reference Publication Year Spectroscopy (RPYS) is a quantitative method for identifying the historical origins of research fields and topics (Baek & Doleck, 2020). RPYS creates a temporal profile of cited references for a set of articles that emphasizes years where relatively significant findings were published. RPYS allows identifying the temporal roots of a discipline. The Reference Publication Year Spectroscopy shows that the journal articles tend to cite references from the more recent period Fig. 8. There seem to be three noticeable peaks before 2005: a peak in 2004 and another peak in 2003 and a rise in 1999. After the peak in 2008, it is evident in the spectroscopy that the number of cited references decrease drastically as the years go up, which again suggests that the articles cite the most recent references over the older ones (Baek & Doleck, 2020). The total number of citations to articles related to the *Journal of Documentation* gradually increased over time from the 1940s. Since 2005, the growth slope has been markedly decreased and could not exceed the peak after 2005. Still, in 2012 it has fallen quickly (Gilani et al., 2019).



**Fig. 8:** Reference Publication Year Spectroscopy (RPYS)

Global citations measure the number of citations an article has received from articles in the entire database, in our case, the Scopus database. Precisely, international citations measure the impact of an article on the whole bibliographic database. Table 8 shows that the most global cited article was

written by Jones KS in 1972, followed by Wilson TD in 1999. TC per year indicates the yearly average number of times each document has been cited. It is notable that the article by Bornmann L, published in 2008, received the highest total TC per year and followed by Wilson TD in 1999 (Baek & Doleck, 2020).

**Table 8: Top 20 most cited articles**

Rank	Articles	DOI	TC	TC per Year
1	Jones KS, 1972	10.1108/eb026526	1793	36.59
2	Wilson TD, 1999	10.1108/EUM0000000007145	1019	46.32
3	Wilson TD, 1981	10.1108/eb026702	689	17.23
4	Bornmann L, 2008	10.1108/00220410810844150	665	51.15
5	Robertson S, 2004	10.1108/00220410410560582	664	39.06
6	Belkin NJ, 1982	10.1108/eb026722	649	16.64
7	Ellis D, 1989	10.1108/eb026843	502	15.69
8	Ingwersen P, 1996	10.1108/eb026960	447	17.88
9	Robertson SE, 1977	10.1108/eb026647	443	10.07
10	Bawden D, 2001	10.1108/EUM0000000007083	388	19.4
11	Almind TC, 1997	10.1108/EUM0000000007205	371	15.46
12	Salton G, 1973	10.1108/eb026562	362	7.54
13	Kuhlthau CC, 1993	10.1108/eb026918	352	12.57
14	Ingwersen P, 1998	10.1108/EUM0000000007167	331	14.39
15	Liu Z, 2005	10.1108/00220410510632040	325	20.31
16	Ellis D, 1997	10.1108/EUM0000000007204	304	12.67
17	Van R CJ, 1977	10.1108/eb026637	296	6.73
18	Ellis D, 1993	10.1108/eb026919	283	10.11
19	Hjørland B, 2002	10.1108/00220410210431136	279	14.68
20	Foster A, 2003	10.1108/00220410310472518	273	15.17

Local citations measure the number of citations an article has received from articles included in the analyzed collection. Table 9 show the local citations measure the impact of an article in the analyzed collection, in our case, the 1,706 research articles and review articles in the *Journal of Documentation* from 1970-2019. With 56 and 45 citations, the most local cited articles are both first-authored by Wilson TD, published in 1999 and 1981. Another article with 34 citations was by Kuhlthau CC, published in 1993, followed by 27 citations was by Mckenzie PJ, published in 2003 (Baek & Doleck, 2020).

**Table 9: Top 20 most local cited documents**

Rank	Document	DOI	Year	LC	GC	LC (%)
1	Wilson TD, 1999	10.1108/EUM0000000007145	1999	56	1019	5.5
2	Wilson TD, 1981	10.1108/eb026702	1981	45	689	6.53
3	Kuhlthau CC, 1993	10.1108/eb026918	1993	34	352	9.66
4	Mckenzie PJ, 2003	10.1108/00220410310457993	2003	27	238	11.34
5	Ingwersen P, 1996	10.1108/eb026960	1996	25	447	5.59
6	Ellis D, 1989	10.1108/eb026843	1989	23	502	4.58
7	Bawden D, 2001	10.1108/EUM0000000007083	2001	21	388	5.41
8	Foster A, 2003	10.1108/00220410310472518	2003	21	273	7.69
9	Lloyd A, 2006	10.1108/00220410610688723	2006	18	135	13.33
10	Lloyd A, 2010	10.1108/00220411011023643	2010	18	97	18.56
11	Frohmann B, 1992	10.1108/eb026904	1992	16	102	15.69
12	Ellis D, 1992	10.1108/eb026889	1992	16	87	18.39
13	Ellis D, 1993	10.1108/eb026919	1993	16	283	5.65
14	Vakkari P, 2000	10.1108/EUM0000000007127	2000	16	159	10.06
15	Belkin NJ, 1982	10.1108/eb026722	1982	15	649	2.31

16	Hjørland B, 2005	10.1108/00220410510578050	2005	15	64	23.44
17	Lloyd A, 2009	10.1108/00220410910952401	2009	15	83	18.07
18	Hjørland B, 1998	10.1108/EUM0000000007183	1998	14	125	11.2
19	Budd JM, 2005	10.1108/00220410510578005	2005	14	55	25.45
20	Ellis D, 1997	10.1108/EUM0000000007204	1997	12	304	3.95
* (LC: Local Citations; GC: Global Citations)						

### WordCloud most frequent author keywords:

The WordCloud is generated through 'Biblioshiny App' of 'Bibliometrix' software. In graphical parameters, author keywords were selected. The main advantage of selecting author keywords is that it provides insight into main topics and research trends. The number of keywords was restricted to 50. In the shape of the figure, the circle was selected.



Fig. 9: WordCloud of most frequent author keywords

The random dark colour was selected as the text colour. The ellipticity and padding values were 0.5 and 1, respectively. As we can observe from Table 10, “information retrieval”, “information science”, “libraries”, “user studies”, “information literacy”, “internet” and “classification”. Are the five keywords known in the *Journal of Documentation*. Fig. 9 shows the most important words used over time, and these are the research hotspots with a high frequency of the keywords used in the *Journal of Documentation* (Taiebi Javid et al., 2019).

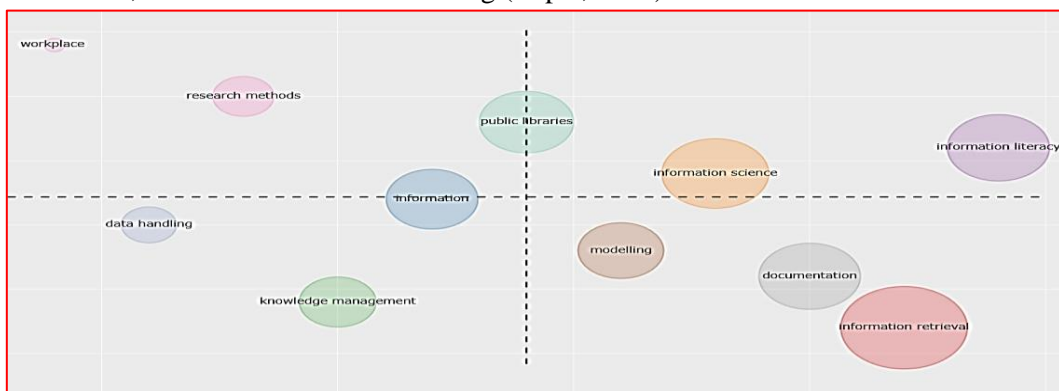
Table 10: Top fifty most popular author keywords used in *Journal of Documentation*

Terms (Frequency)	Terms (Frequency)	Terms (Frequency)
information retrieval (138)	epistemology (28)	United Kingdom (19)
information science (80)	information systems (28)	indexing (18)
libraries (61)	research (28)	modelling (18)
user studies (57)	archives (26)	electronic journals (17)
information literacy (56)	documentation (26)	information society (17)
internet (55)	philosophy (26)	classification schemes (16)
classification (53)	documents (24)	communities (16)
information management (48)	information seeking (24)	individual behaviour (16)
information behaviour (46)	information services (23)	information studies (16)
information research (45)	worldwide Web (23)	librarians (16)
information (42)	history (22)	searching (16)
digital libraries (38)	research methods (22)	theory (16)
public libraries (37)	academic libraries (20)	learning (15)
knowledge management (34)	information theory (20)	literacy (15)
communication (29)	semantics (20)	students (15)
information searches (29)	document management (19)	books (14)
behaviour (28)	library users (19)	



of the research themes can be measured through centrality while density traces the evolution of themes (Aria & Cuccurullo, 2017).

The thematic map consists of eleven clusters of the label ‘information retrieval’ largest cluster comprehending 56 subthemes occurring 995 times. The prominent themes in this cluster are information retrieval (138), user studies (57) and internet (55), information management (48). ‘Information science’ has been the second-largest cluster which consisted of 18 subthemes occurring 371 times wherein information science (80), libraries (61), classification (53) and epistemology (28). The third-largest cluster is denoted by the themes ‘information literacy’, which included 28 subthemes in it, getting noted for occurring 291 times. Information literacy (56), information behaviour (46), information seeking (24) and information practices (13). ‘Documentation’ reflects the fourth largest cluster, embedded with 26 subthemes in-it with, occurring 285 times. The prominent subthemes have been Documentation (26), archives (26), documents (26) and history (26). The label ‘public libraries’ represented the fifth cluster with 21 subthemes of 200 times. Public libraries (37), library users (19), librarians (16) and books (14) were the centre point of study in this cluster. The sixth cluster of ‘information includes 14 subthemes with 173 occurrences leading with information (42), communication (29), learning (15) and literacy (15) each. The seventh cluster is of ‘modelling’, which contains 16 sub-themes in itself, occurring 129 times. Modelling (18), cataloguing (14), bibliographic systems (12) and metadata (11). ‘Knowledge management’ as the eighth cluster, which has seven subthemes with 83 times occurrence. Knowledge management (34), phenomenology (14), knowledge processes (10) and knowledge organizations (9). Nineth cluster ‘research methods’, which is portrayed three subthemes with 38 times occurring, research methods (22), qualitative research (11) and content analysis (5). The tenth and eleventh clusters containing 4 and 1 subthemes, with 28 and 5 times occurring (Bapte, 2020).



**Fig. 12:** Thematic map in Journal of Documentation

### Two-Plot diagram for the Evolution of Author’s Keywords over the years

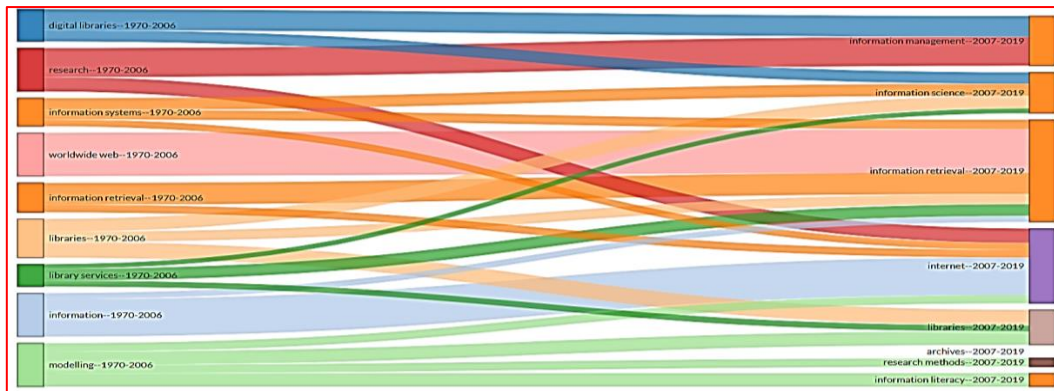
Table 11 and Fig. 13 portrays the distribution and diversity of topics on the thematic evolution of the author’s keywords over the years in the given time. In all the topics have started uniquely and topics such as ‘knowledge workers’, ‘digital libraries’, ‘information management’, ‘information science’, ‘research’, ‘internet’, ‘information systems’, ‘information retrieval’, ‘worldwide web’, ‘libraries’ and ‘modelling’ have diverged into various fields. In Occurrences from information retrieval-1970-2006, to information retrieval-2007-2019, ‘information retrieval’, ‘United Kingdom’, ‘search engines’ and ‘information searches’ were words in thematic evolution analysis with 49 times. In weighted inclusion index from worldwide web-1970-2006, to information retrieval-2007-2019, words by searching; worldwide Web is leading the index table with 1.00. In inclusion index from research-1970-2006, to information management-2007-2019, words by research with 0.05. Instability index from modelling-1970-2006, to libraries-2007-2019, public libraries as words with 0.06.

**Table 11: Thematic Evolution of Author's Keywords**

From	To	Words	O	WII	II	SI
digital libraries--1970-2006	information management--2007-2019	information management; digital libraries	9	0.48	0.17	0.04
digital libraries--1970-2006	information science--2007-2019	knowledge management	12	0.26	0.17	0.03
research--1970-2006	information management--2007-2019	research	8	0.67	0.50	0.04
research--1970-2006	internet--2007-2019	behaviour	4	0.33	0.50	0.04
information systems--1970-2006	information science--2007-2019	information systems	14	0.27	0.20	0.03
information systems--1970-2006	information retrieval--2007-2019	information services	11	0.22	0.20	0.03
information systems--1970-2006	internet--2007-2019	information society	8	0.16	0.20	0.04
worldwide web--1970-2006	information retrieval--2007-2019	searching; worldwide web	4	1.00	0.50	0.03
information retrieval--1970-2006	information retrieval--2007-2019	information retrieval; united kingdom; search engines; information searches	49	0.50	0.08	0.02
information retrieval--1970-2006	internet--2007-2019	internet	25	0.18	0.08	0.03
libraries--1970-2006	libraries--2007-2019	libraries; philosophy	27	0.36	0.11	0.05
libraries--1970-2006	information science--2007-2019	information science; epistemology	26	0.30	0.11	0.03
libraries--1970-2006	information retrieval--2007-2019	user studies; information research; united states of America	9	0.23	0.11	0.02
library services--1970-2006	information retrieval--2007-2019	electronic journals; user interfaces	6	0.27	0.14	0.03
library services--1970-2006	information science--2007-2019	serials	6	0.11	0.14	0.03
library services--1970-2006	libraries--2007-2019	library users	5	0.14	0.14	0.05
information--1970-2006	internet--2007-2019	communication; information; information theory	5	0.86	0.25	0.04
information--1970-2006	information retrieval--2007-2019	learning	4	0.14	0.25	0.03
modelling--1970-2006	information literacy--2007-2019	modelling	8	0.31	0.25	0.03
modelling--1970-2006	research methods--2007-2019	cataloguing	5	0.19	0.25	0.05
modelling--1970-2006	libraries--2007-2019	public libraries	8	0.31	0.25	0.06
modelling--1970-2006	internet--2007-2019	books	5	0.19	0.25	0.04

\*(O-Occurrences; WII-Weighted Inclusion Index; II-Inclusion Index & SI-Stability Index)





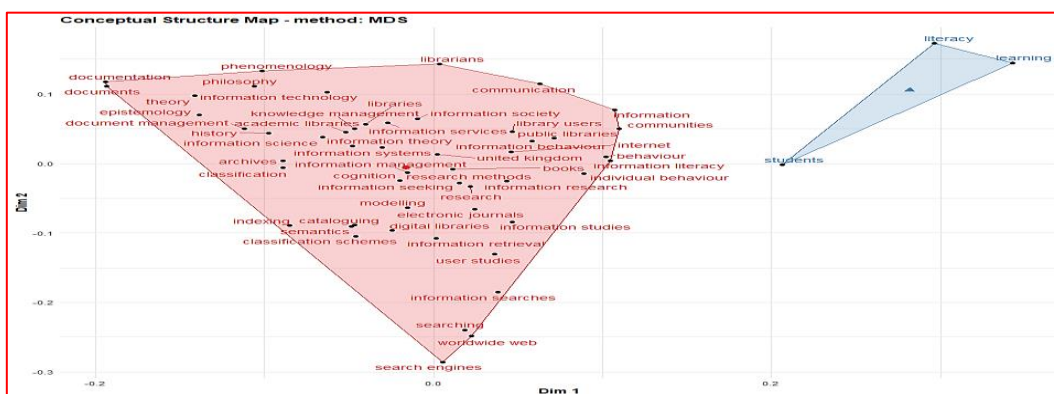
**Fig. 13:** 2-Plot diagram for the Evolution of Author’s Keywords over the years

### Conceptual Structure Analysis of author’s keywords

#### A. Conceptual Structure Map of multi-dimensional scaling in Journal of Documentation

Conceptual structure analysis determines the main themes and trends that have been studied and explained in the *Journal of Documentation*. It represents themes based on the relationship between the keywords. To inform the research community regarding the most relevant concepts, a co-word analysis has been performed and explained, and it is used to study the structure of a field (Sharma et al., 2020). Author keywords analysis identified two clusters representing different themes from Fig. 14. The result is interpreted based on the relative position of the point. Keywords closer to each other, represent a large portion of the article taken together; they are distant. A small proportion of the article treats these keywords together.

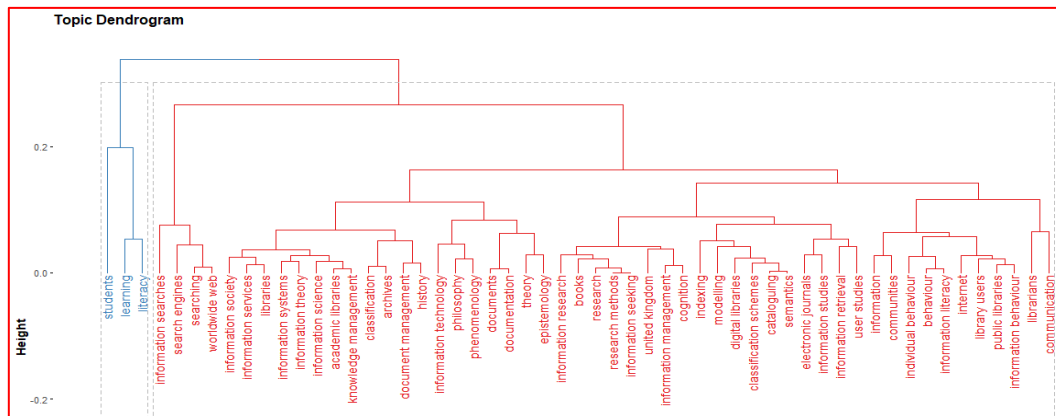
Cluster 1 (red colour) comprises articles regarding learning and study abroad in the *Journal of Documentation*. The most significant cluster consists of 47 keywords: information retrieval, information science, libraries, user studies, information literacy, internet, classification, information management, information behaviour, and information research. Cluster 2 (blue colour) focuses on the studies based on ‘students’, ‘literacy’, and ‘learning’ which is the smallest cluster with three authors keywords.



**Fig. 14:** Conceptual structure Map of Multi-dimensional scaling of authors keywords

#### B. Tree dendrogram of hierarchical cluster analysis in Journal of Documentation

A dendrogram is a tree diagram frequently used to illustrate the clusters produced by hierarchical clustering. Dendrograms are widely utilized in specific subject classification and their connection to other topics as the order of these themes portrayed in different colours. The portrayal of the dendrogram diagram is frequently utilized in various sets; for instance, in a chain of command of collection, this outline depicts the dissemination of connections between components in grouping resulting from software analysis. This grouping is also arranged in such a way as to take into account the height of the coordination line between topics and between clusters.

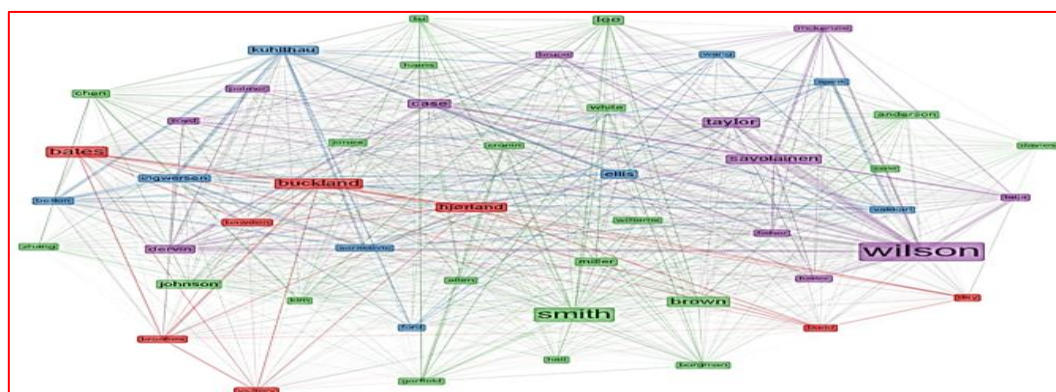


**Fig. 15:** Tree dendrogram of hierarchical cluster analysis of the author’s keywords

The dendrogram shows two groupings of topics, specific points in red and blue themes, which offers the connection between points in the dark blue arrangement and subjects in red characterization. Each of them is also separated into a few clusters. Each group is further partitioned into a few sub-clusters and so on until the topic is used. Several topics are part of one cluster, indicating a relationship between the clusters (Rusydia & Nailah, 2020). In hierarchical agglomerative grouping prompts the dendrogram, which recommends yielding three clusters. To validate these suggestions, we execute silhouette analysis which gives a graphical portrayal of how well each object has been grouped and classified. Three clusters present: higher average silhouette width than 4 and 5 clusters; none observation assigned to the wrong cluster and very few borderline observations. Therefore three clusters are the optimal choice. The silhouette plot Fig.15 shows the cluster size (Izzo & Camminatiello, 2020) (Firdaus et al., 2019).

### Co-citation Networks

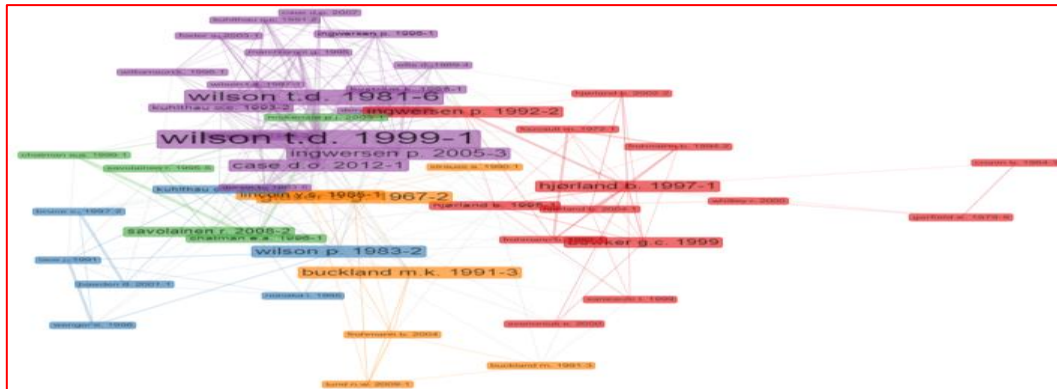
A Co-citation network considered bibliographic coupling is a semantic similarity to measure the documents that utilize reference connections/relationships. Co-citation is the frequency with which two or more documents are cited together by other documents (Aria & Cuccurullo, 2017). Co-citation network structure reveals the most cited authors are Wilson TD. The network structure consists of clusters in which each colour represents a component. Fig.16 represents four clusters in four various colours.



**Fig. 16:** Author-wise collaboration Network

As shown in Fig. 17, the co-citation network identified four clusters in four different colours. Cluster 1 (red) identifies papers that explain applying the social cognitive framework for learning in tourism and hospitality education (Bandura, 1986; Lent et al., 1994). The document published by Bandura

(1986) seems to play a key role in this cluster with a between the centrality of 20.93 and the connection between this work, and that of Lent et al. (1994) and Hsu and Wolfe (2003) are incredibly insightful. Cluster 2 (purple) mainly focuses on the vital skill to produce quality manpower (Raybould& Wilkins, 2006) and the disciplinary dilemma of tourism (Bloom, 1956; Echtner& Jamal, 1997).



**Fig. 17:** Co-citation network

The article (Tribe, 1997) takes a pivotal role in this cluster, which describes tourism studies that can be conceptualized in two fields: business and non-business aspects of tourism. Along with this, the works of Echtner and Jamal (1997) and Bloom (1956) also play an essential role. Cluster 3 (blue) emphasizes the significance of internship and training in the tourism and hospitality curriculum and student perception towards working in the tourism industry (M. Cho, 2006; Kusluvan & Kusluvan, 2000). Kusluvan and Kusluvan (2000) and Lam and Ching (2007) are the most influential article in this cluster. Cluster 4 (green) highlights the importance of information technology in learning and the future direction and perspective of travel and tourism education (Conrad & Bill, 2005; P. P. Sheldon et al., 2007). This cluster also presents the curriculum for tourism education and experiential learning value (Tribe, 2002).

### Country collaboration network

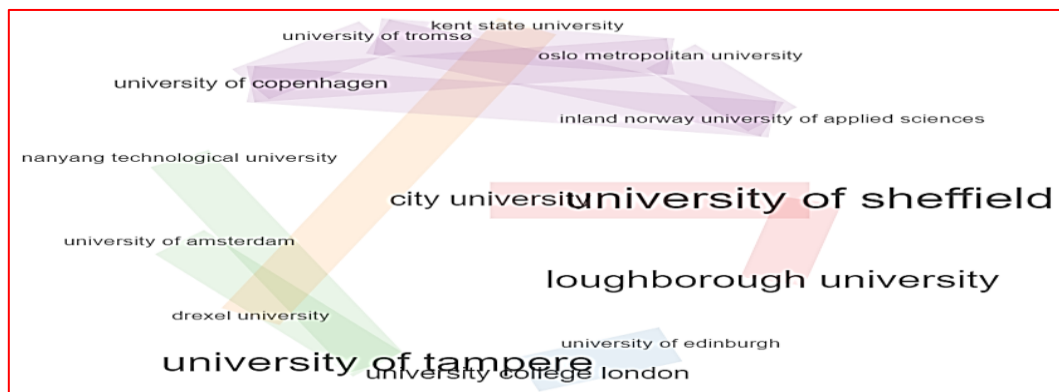
In the interest of detecting the countries that were actively collaborating, Fig. 18 provides a record of networking circles of collaboration. Collaboration is a network that will indicate how the authors are linked to the network due to their co-authorships (Glänzel and Schubert 2004). As shown in the figure, the coloured circle noted in each node of the network represents the total number of articles. The figure depicts that the Authors from UK has greater collaboration rate with others countries. (Firdaus et al., 2019).



**Fig. 18:** Country-wise Collaboration Network

### Affiliation collaboration network

The colored node in the network, as shown in Fig. 19, represents the collaboration of the network between universities and colleagues from different countries. The University College London from the United Kingdom collaborates with the London School of Economics. The purple colour node represents five institutes that collaborate between Air Force Research Laboratory, Tennessee State University, Old Dominion University from the United States of America, Institute of Information Engineering and University of Chinese Academy of Sciences from China. The red colour node represents the collaboration between the National University of Defense Technology, Qingdao Academy of Intelligent Industries from China and Institute of Automation from Jerman. This figure reveals that China's universities preferred to collaborate with their own country compared to others.



**Fig. 19:** Affiliation collaboration network

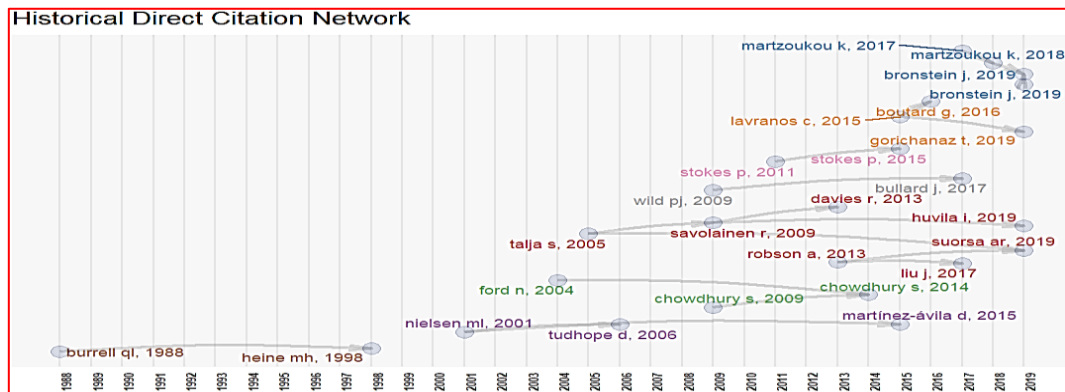
### Legend of historiographic mapping

Historiographic analysis, also known as a historiograph or historiographic mapping, represents a chronological mapping of the most relevant citations (Aria & Cuccurullo, 2017). With the *histNetwork function*, this study generated a plot with the most productive 25 articles, as shown in Fig. 20. The list of the top ten articles is shown in Table 12. The direction of the arrows in Fig. 20 explains the chronological change of research trends from the past. For example, Jones KS published an article in 1972 on “A statistical interpretation of term specificity and its application in retrieval”, and then Van Rijsbergen, CJ published an article in 1977 on “A theoretical basis for the use of co-occurrence data in information retrieval”. This kind of contributions was promoting the research community to deal with “statistical application”, “information retrieval”, and “user studies and information needs” and most of the studies finally brought about teacher, experts (instructor) education in Library and Information Science (Jho, 2018).

**Table 12: Legend of historiographic mapping**

First Author	Title	Year	LC	GC
Jones KS	A statistical interpretation of term specificity and its application in retrieval	1972	9	179 3
Van Rijsbergen CJ	A theoretical basis for the use of co-occurrence data in information retrieval	1977	8	296
Oddy RN	Information retrieval through man-machine dialogue	1977	7	137
Burrell Q	A simple stochastic model for library loans	1980	9	85
Wilson TD	On user studies and information needs	1981	45	689
Belkin NJ	Ask for information retrieval: Part I. Background and theory	1982	15	649
Ellis D	A behavioural approach to information retrieval system design	1989	23	502
Frohmann B	Rules of indexing: A critique of mentalism in information	1990	8	56

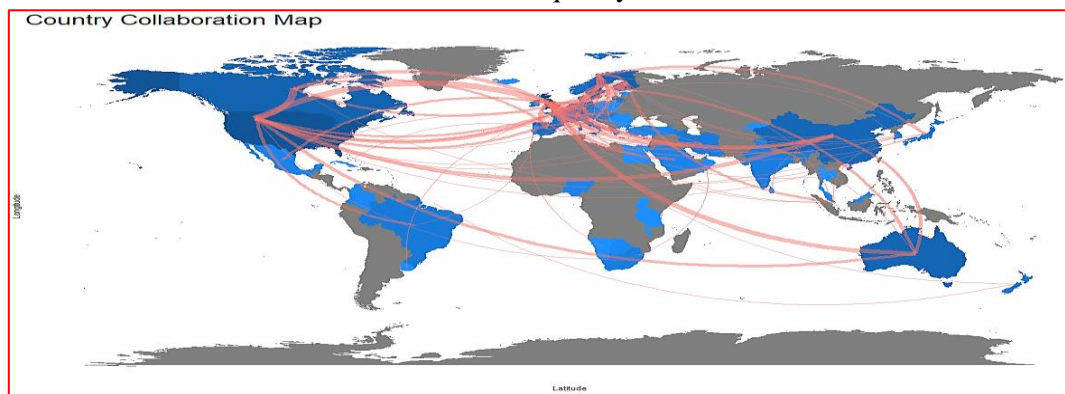
	retrieval theory			
Frohmann B	The power of images: A discourse analysis of the cognitive viewpoint	1992	16	102
Ellis D	The physical and cognitive paradigms in information retrieval research	1992	16	87
*(LC: Local Citations; GC: Global Citations)				



**Fig. 20:** Legend of historiographic mapping

### Collaboration WorldMap

Fig. 21 shows that most collaborations have been co-authored by authors from the United Kingdom to 29 countries in frequency by leading USA (10), Australia and China (6), Iran (5), Canada (4), Denmark, Greece, Ireland, Italy, Saudi Arabia, and Switzerland with three frequency each. Belgium, Finland, Germany, Mexico, Netherlands and Spain with two frequency each. Austria, Bahrain, Egypt, France, Israel, Korea, Kuwait, and Namibia, one frequency.



**Fig. 21:** Country-wise Collaboration map

### CONCLUSIONS AND IMPLICATIONS

This study aimed to provide an overview of the *Journal of Documentation* internationally published journal using bibliometric analysis with R software. One thousand seven hundred six articles were extracted using the Scopus database. The collected referential information followed descriptive and network analysis. The descriptive study showed a gradual growth of publications since the 1997s and increasing distribution of research publications. The purpose of using thematic evolution for the analysis is to discover if any topics have emerged into any other quadrants and more so to understand the topic's evolution over some time. The span of years is divided into two parts, and the cutting point emerged annual scientific production and average citations during the fifty years of study in which articles initiated in 1970 and have had an uptrend till 2019, reaching 108 articles in 2019 and declining slightly in the year 1989 and 1993 with 13 articles followed by 1985 with 14 articles. The

Journal has an impact with an h-index of 80, with a g-index of 148, having total citations of 37,161 with 1706 for the period of fifty years from 1970-2019. The thematic map consists of eleven clusters of the label ‘information retrieval’ largest cluster comprehending 56 subthemes occurring 995 times. Cronin B has the highest 14 H-index and 18 numbers of articles with 630 citations followed by Ford N. In the second place is Oppenheim C with 13 H-index and 19 numbers of articles and 638 citations followed by Willett P ranked 3rd with the 12 H-index and 19 and 22 articles with 588 and 418 citations. This suggests that these authors are the most productive authors with active and frequent publication in the *Journal of Documentation* during 1970-2019. The study implies “*Journal of Documentation*” to be a productive and an impactful research journal promoting multidisciplinary research, publishing original, innovative, cutting-edge and state-of-the-art research works of eminent educationist, scholars and practicing information science professionals encompassing all academic and professional’s disciplines dealing with recorded information.

## REFERENCES:

- Aria, M., & Cuccurullo, C. (2017). bibliometrix: An R-tool for comprehensive science mapping analysis. *Journal of Informetrics*, 11(4), 959–975. <https://doi.org/10.1016/j.joi.2017.08.007>
- Baek, C., & Doleck, T. (2020). A Bibliometric Analysis of the Papers Published in the Journal of Artificial Intelligence in Education from 2015-2019. *International Journal of Learning Analytics and Artificial Intelligence for Education (IJAI)*, 2(1), 67–84.
- Bapte, V. (2020). The Documents Published in The Electronic Library: A Scientometric Overview. *Library Philosophy and Practice (e-Journal)*. <https://digitalcommons.unl.edu/libphilprac/4413>
- Chen, X., Zou, D., & Xie, H. (2020). Fifty years of British Journal of Educational Technology: A topic modeling based bibliometric perspective. *British Journal of Educational Technology*, 51(3), 692–708. <https://doi.org/10.1111/bjet.12907>
- Dutta, B. (2014). The journey from librmetry to altmetrics: A look back. *Golden Jubilee Celebration of Department of Library and Information Science, Jadavpur University*, 1–20. <http://eprints.rclis.org/23665/2/B-Dutta-JU-Golden-Jubilee-Paper.pdf>
- Firdaus, A., Razak, M. F. A., Feizollah, A., Hashem, I. A. T., Hazim, M., & Anuar, N. B. (2019). The rise of “blockchain”: Bibliometric analysis of blockchain study. *Scientometrics*, 120(3), 1289–1331. <https://doi.org/10.1007/s11192-019-03170-4>
- Gilani, E., Salimia, D., Jouyandeh, M., Tavasoli, K., & Wong, W.-K. (2019). A trend study on the impact of social media in decision making. *International Journal of Data and Network Science*, 201–222. <https://doi.org/10.5267/j.ijdns.2019.2.004>
- Hirsch, J. E. (2005). An index to quantify an individual’s scientific research output. *Proceedings of the National Academy of Sciences*, 102(46), 16569–16572. <https://doi.org/10.1073/pnas.0507655102>
- Izzo, F., & Camminatiello, I. (2020). Gaming for Healthcare: A Bibliometric Analysis in Business and Management. *International Business Research*, 13(12), 27. <https://doi.org/10.5539/ibr.v13n12p27>
- Jho, H. (2018). The Past and the Present of Physics Education at a Glance: A Review of International Studies on Physics Education by Using Science Mapping Tool. *New Physics: Sae Mulli*, 68(10), 1096–1106. <https://doi.org/10.3938/NPSM.68.1096>
- Kent Baker, H., Satish Kumar, & Pattnaik, D. (2020). Fifty years of The Financial Review: A bibliometric overview. *Financial Review*, 55(1), 7–24. <https://doi.org/10.1111/fire.12228>
- Kondaveeti, H. K., Raman, S., & Raj, P. (2020). Prototyping with Raspberry Pi in Healthcare Domain. *International Journal of Advanced Computer Science and Applications*, 11(10). <https://doi.org/10.14569/IJACSA.2020.0111038>
- Li, Z. C., Huang, H. J., & Yang, H. (2020). Fifty years of the bottleneck model: A bibliometric review and future research directions. *Transportation Research Part B: Methodological*, 139, 311–342. <https://doi.org/10.1016/j.trb.2020.06.009>

- Martínez-López, F. J., Merigó, J. M., Valenzuela-Fernández, L., & Nicolás, C. (2018). Fifty years of the European Journal of Marketing: A bibliometric analysis. *European Journal of Marketing*, 52(1/2), 439–468. <https://doi.org/10.1108/EJM-11-2017-0853>
- Merigó, J. M., Pedrycz, W., Weber, R., & de la Sotta, C. (2018). Fifty years of Information Sciences: A bibliometric overview. *Information Sciences*, 432, 245–268. <https://doi.org/10.1016/j.ins.2017.11.054>
- Milfont, T. L., Amirbagheri, K., Hermanns, E., & Merigó, J. M. (2019). Celebrating Half a Century of Environment and Behavior: A Bibliometric Review. *Environment and Behavior*, 51(5), 469–501. <https://doi.org/10.1177/0013916519843126>
- Modak, N. M., Merigó, J. M., Weber, R., Manzor, F., & Ortúzar, J. de D. (2019). Fifty years of Transportation Research journals: A bibliometric overview. *Transportation Research Part A: Policy and Practice*, 120, 188–223. <https://doi.org/10.1016/j.tra.2018.11.015>
- Priem, J., & Hemminger, B. H. (2010). Scientometrics 2.0: New metrics of scholarly impact on the social Web. *First Monday*. <https://doi.org/10.5210/fm.v15i7.2874>
- Rusydiana, A. S., & Nailah. (2020). The Zakat & Technology: Bibliometric R. *4th International Conference of Zakat Proceedings*, 311–330. <https://doi.org/10.37706/iconz.2020.222>
- Sharma, P., Singh, R., Tamang, M., Singh, A. K., & Singh, A. K. (2020). Journal of teaching in travel & tourism: A bibliometric analysis. *Journal of Teaching in Travel & Tourism*, 1–22. <https://doi.org/10.1080/15313220.2020.1845283>
- Shuang, H. (2019). Fifty years of IISE Transactions: A bibliometric overview. *IOSR Journal of Mechanical and Civil Engineering*, 16(4), 76–87. <https://doi.org/10.9790/1684-1604027687>
- Sigifredo, L., Verma, R., & Merigo, J. M. (2018). Fifty years of the journal of optimization theory and applications: A bibliometric overview. *Lectures on Modelling and Simulation*, 20–25.
- Taiebi Javid, E., Nazari, M., & Ghaeli, M. R. (2019). Social media and e-commerce: A scientometrics analysis. *International Journal of Data and Network Science*, 269–290. <https://doi.org/10.5267/j.ijdns.2019.2.001>
- Zou, X., Vu, H. L., & Huang, H. (2020). Fifty Years of Accident Analysis & Prevention: A Bibliometric and Scientometric Overview. *Accident Analysis & Prevention*, 144, 105568. <https://doi.org/10.1016/j.aap.2020.105568>



Rajajinagar Education Society's

**SRI AUROBINDO COLLEGE**

Affiliated to Bangalore University & NAAC Accredited B+  
#6/c, 5<sup>th</sup> Main, Dr M.C.Modi Road, Mahalakshmpuram, Bengaluru-86  
www.sriarobindocollege.ac.in Ph: 080-23492449



**A ONE DAY NATIONAL SEMINAR**  
on  
**"PORTRAYAL OF INDIAN  
CULTURE IN LITERATURE"**

**15 July 2022**

organised by

**Departments of Languages**

in Association with

**Internal Quality Assurance Cell**



**Copy Right - 2022**  
**ISBN No - 978-93-85291-13-5**

**Publishers Address**

**EnkayBooks & Infotech**  
**#209, Harisadan, 20 Ansari Road, New**  
**Delhi - 110002**

Prof. H.S. Venkateshwarlu  
Poet, Writer, Translator

(ಸಂಸ್ಕೃತ ವಿಭಾಗ)

ಲೇಖಕರ ಹೆಸರು

ಪ್ರಬಂಧದ ಶೀರ್ಷಿಕೆ

ಕ್ರಮ ಸಂಖ್ಯೆ	ಪ್ರಬಂಧದ ಶೀರ್ಷಿಕೆ	ಲೇಖಕರ ಹೆಸರು
32	ಸುಭಾಷಿತೇಷು ನಿಹಿತಂ ಭಾರತೀಯಾ ಸಂಸ್ಕೃತಿ	ಶ್ರೀಮತಿ. ಭಾಮತಿ ಭದ್ರ
33	ವೇದಪುರಾಣಮಹಾಕಾವ್ಯಾದಿಪು ಭಾರತೀಯಸಂಸ್ಕೃತೇ: ಚಿತ್ರಣಮ್	ಶ್ರೀ. ಗಣಪತಿ ಭದ್ರ:
34	ಇತಿಹಾಸ ಪುರಾಣೇಷು ವೈರುಧ್ಯಾನಾಂ ಪರಿಹಾರೋಪಾಯಾ:	ಶ್ರೀ. ಡಾ. ಎಂ.ಜಿ.ನಂದನ ರಾವ:
35	ಕಾವ್ಯಶಿಖಾರ್ಥನಾರ್ಥಮ್ ಅಲಂಕಾರಾಗಾಮ್, ಅಲಂಕಾರಶಾಸ್ತ್ರ ಗ್ರಂಥಾನಾಂ ಯೋಗದಾನಮ್	ಶ್ರೀ. ಎನ್.ಆರ್.ವಾಹಲೀಕ ರಾವ
36	ರಾಜಶೇಖರಕೃತ ಕಾವ್ಯಮಿಮಾಂಸಾಯಾಂ ಭಾರತೀಯ ಸಂಸ್ಕೃತಿ:	ಶ್ರೀಮತಿ. ಡಾ. ಪದ್ಮಾವತಿ ಎಂ. ಸಿಡ್ಡಿಗಾರಿ
37	ಸಂಸ್ಕೃತ ಸಾಹಿತ್ಯೇ ಭಾರತೀಯ ಸಂಸ್ಕೃತೇ: ಚಿತ್ರಣಮ್	ಶ್ರೀ. ಶಿವರಾಮ ಗುಪ್ತ ವಿ.
38	ಸುಂದರಕಾಂಡೇ ಸಮೃದ್ಧಿಸಿತಾನಿ ಮಾನವೀಯ ಮೌಲ್ಯಾನಿ	ಶ್ರೀ. ಡಾ. ಶ್ರೀಕೃಷ್ಣ ಎಚ್. ಕಾಕುಂಡಕಿ
39	ಹರಿವಂಶಪುರಾಣೇ ಸಂಸ್ಕೃತೇ: ನಿರೂಪಣಮ್	ಶ್ರೀ. ಶ್ರೀನಿಧಿ ಅಭಯಚಂದ್ರ:
40	ವೇದ ಪುರಾಣ ಮಹಾಕಾವ್ಯಾದಿಪು ಭಾರತೀಯ ಸಂಸ್ಕೃತೇ: ಚಿತ್ರಣಮ್	ಶ್ರೀ. ಡಾ. ತಿರುಮಲ ಹೇಗಡೆ
41	ಸಂಸ್ಕೃತಸಾಹಿತ್ಯೇಷು ಭಾರತೀಯ ಸಂಸ್ಕೃತೇರಂಗಭೂತಂ ಶಿಕ್ಷಣಮ್	ಶ್ರೀ. ವಾದಿರಾಜ:
42	ಗೀತಾರ್ಥ ವಿವರಣ ಪ್ರತಿಪಾದಿತ ಜೀವನ ನಿರ್ವಹಣ ಸ್ವಾಭಿಪ್ರಾಯಾಣಿ	ಶ್ರೀ. ವಿನಯ ಕುಮಾರ:
43	ವೇದಾಂತೇಷು ಪ್ರಸ್ಥಾನತ್ರಯಭಾಷ್ಯಾಣಿ	ಶ್ರೀ. ರಾಮಚಂದ್ರ ಎನ್.ಯು
44	ಭಾರತೀಯ ವೈದ್ಯಪದ್ಧತಿಯಲ್ಲಿ ಆಹಾರ ಸಂಸ್ಕೃತಿ	ಶ್ರೀಮತಿ. ಡಾ. ಅಂಜನಾ ಮಠದ
45	ಸಂಸ್ಕೃತ ಗ್ರಂಥಗಳಲ್ಲಿ ಸಂಸ್ಕೃತಿಯ ಅನಾವರಣ	ಶ್ರೀಮತಿ. ಡಾ. ದೀಪಶ್ರೀ ಎಸ್.
46	ಕಾವ್ಯ ಶೋಭೆಯನ್ನು ಹೆಚ್ಚಿಸುವಲ್ಲಿ ಅಲಂಕಾರಗಳು.	ಶ್ರೀ. ದ್ವಾರಕೀಶ ಎಂ
47	ಅಲಂಕಾರಶಾಸ್ತ್ರಕ್ಕೆ ರುದ್ರಟನ ವಿಶಿಷ್ಟ ಯೋಗದಾನ	ಶ್ರೀ ಕೆ.ಕೃಷ್ಣಮೂರ್ತಿ ಮಯ್ಯ
48	ರಾಮಾಯಣದ ಆದರ್ಶ ಪಾತ್ರಗಳು ತಿಳಿಸುವ ಜೀವನ ಮೌಲ್ಯಗಳು	ಶ್ರೀಮತಿ. ಡಾ.ಮೃತೇಯಿ ಎಚ್. ಎಲ್
49	ಸಂಸ್ಕೃತ ಸಾಹಿತ್ಯದಲ್ಲಿ ಭಾರತೀಯ ಸಂಸ್ಕೃತಿಯ ಚಿತ್ರಣ	ಶ್ರೀ. ನಾಗೇಶ ಎಸ್. ಡೊಂಗಾರಿ
50	ವೇದ - ಪುರಾಣ - ಮಹಾಕಾವ್ಯಗಳಲ್ಲಿ ಭಾರತೀಯ ಸಂಸ್ಕೃತಿಯ ಚಿತ್ರಣ	ಶ್ರೀ. ಪೂರ್ಣಪ್ರಜ್ಞಾಪಾರ್ಥಿ ಸಿ ಮಳಗಿ
51	ವೇದ ಪುರಾಣ ಮಹಾಕಾವ್ಯಾದಿಪು ಭಾರತೀಯ ಸಂಸ್ಕೃತೇ: ಚಿತ್ರಣಮ್	ಶ್ರೀ. ಶಿವಾನಂದ ಎಲ್ ಬಿ
52	ಭಾರತೀಯ ಸಂಸ್ಕೃತಿಯಲ್ಲಿ ಆದರ್ಶಗಳು	ಶ್ರೀ. ಶ್ರೀಶ ಪಾವಂಜಿ
53	ಶ್ರೀ ರಾಮಾಯಣ , ಮಹಾಭಾರತ ನಾಟಕಾದೀಪು ಸಂಸ್ಕೃತಿ	ಶ್ರೀ. ಡಾ. ಸುಬ್ರಹ್ಮಣ್ಯ ಭಟ್ಟ
54	ಪೋಷಣಾ ಆದರ್ಶಪಾತ್ರಾಣಿ ಜೀವನ ಮೌಲ್ಯಾನಿ ಚಿತ್ರಣ	ಶ್ರೀ. ಡಾ. ಎನ್.ಎಸ್. ಸುರೇಶ,
55	ಕವಿಹುಲಗುರು ಕಾಳಿದಾಸನ ಕಾವ್ಯಗಳಲ್ಲಿ ಭಾರತೀಯ ಸಂಸ್ಕೃತಿ	ರಾಮಕುಮಾರ್
56	ಭಾಸ ಕವಿಯ ನಾಟಕಗಳಲ್ಲಿ ಸಂಸ್ಕೃತಿಯ ಪೋಷಣೆ ಮತ್ತು ಜೀವನ ಮೌಲ್ಯಗಳು	ಶ್ರೀಮತಿ. ಸುಷ್ಮಾ ಎಚ್.ಆರ್.
57	ಕಾಳಿದಾಸನ ಕಾವ್ಯಗಳಲ್ಲಿ ಭಾರತೀಯ ಸಂಸ್ಕೃತಿ	ಶ್ರೀ. ಡಾ. ಸೆಲ್ವಪ್ಪ
58	ಮಕ್ಕಳ ಲಾಲನೆ-ಪಾಲನೆ: ಬಾಣಾಕ್ಷನ ದೃಷ್ಟಿ	ಡಾ. ಗಣಪತಿ ಆರ್ ಭಟ್
59	Concept of food culture in ancient era	Smt. Dr. Geeta kumashikar
60	Guru Shishya tradition. A part of ancient culture in Mahabharata perspective	Smt. Dr. Padmaja D.S
61	A conceptual view on Indian culture in Shravya Drushya Kaavyas	

Smt. Roopa vijay

ಸಾಹಿತ್ಯದಲ್ಲಿ

ಎಚ್

ಒಂದು ದೇಶದ ಜನರ ನಡವಳಿಗಳನ್ನು ಸಾಹಿತ್ಯವು ಮೊದಲಿಂದಲೂ ಭಾರತೀಯರು ಅವರ ಸಂಬಂಧ ಹೇಗಿದೆ ದೇವರು ಅ ಮೊದಲಾದ ಸಂಗತಿಗಳನ್ನು ಕುರಿತು ಗಂ ಮಹಾಭಾರತ ಭಾಗವತದಂಥ ಕೃತಿಗಳ ಬಂದಿದ್ದಾರೆ. ಅಕ್ಷರ ಅರಿಯದವರೂ ಭ ನೋಡುಗ ಸಂಸ್ಕೃತಿ ಅದಕ್ಕೆ ಕಾರಣ. ಹ ಸಮುದಾಯದಲ್ಲಿ ಕೇಳಿಸುತ್ತಾ ನೋಡಿ ನಮ್ಮದು. ಗಮಕವಾಚನ ಮಾಡುವವ ಮೂದೇಶ್ವರ,ಮಂಟೇಸ್ಸಾಮಿ, ಅರ್ಜುನ ಮನೆಯಲ್ಲೋ,ಸಾಮಾನ್ಯರ ಮನೆ ನಡೆಯುತ್ತಿದ್ದ ಬಯಲಾಟ, ಯಕ್ಷಗ ಹಾಡಿನ ರೂಪದ ಕಥೆಗಳನ್ನು ಗಮನಿಸಬೇಕು. ಸಾಹಿತ್ಯ ಎಂಬುದು ಕೃಷ್ಣ, ಹರಿಶ್ಚಂದ್ರ, ನಳ ಮೊದಲಾದ ಸಾಹಿತ್ಯ ಧೀರೋದಾತ್ತವಾಗಿ ಚಿತ್ರ ಮೂಲಗುರಿ ಇದೇ.ರಾಮಾಯಣ ತಮ್ಮ ಬದುಕಿನ ಸಂದರ್ಭದಲ್ಲಿ ಸಂಸ್ಕೃತದಲ್ಲಿ ಹುಟ್ಟಿದ ಮಹಾ ಬಂದಿರುವುದನ್ನು ನಾವು ನೆನೆಯ ಹಳ್ಳಿಹಳ್ಳಿಯಲ್ಲೂ ಬೆಳೆದುಕೊಳ್ಳು ಇಲ್ಲಿ ಸೀತ ಅಡುಗೆ ಮಾಡಿದ್ದಳು

# वेद-पुराण-महाकाव्यादिषु भारतीयसंस्कृतेः चित्रणम्

-डा. तिरुमलः, सहप्राध्यापकः-सुरानामहाविद्यालयः

उत्तरं यत्समुद्रस्य हिमाद्रेः श्रैव दक्षिणम् । वर्षं तद्भारतं नाम भारती यत्र सन्ततिः ॥

हिमालयं समारभ्य यावदिन्दुसरोवरम् । तं देवनिर्मितं देशं हिन्दुस्थानं प्रचक्षते ॥(विष्णुपुराणम्)

हिमालयहिन्दुमहासागरयोर्मध्ये विद्यमानायामस्यां पुण्यकर्मभूमौ विराजते आर्षपरम्परान्विता भारतीसन्ततिः । सन्ततिरेषा सम्भाषते संस्कृतादिविविधभाषाः सुखेन जीवति च । सम्पर्कसाधनीभूतभाषासु मुख्या मधुरा दिव्या गीर्वाणभारतीत्यादिनाम्ना प्रसिद्धा प्राचीना च संस्कृतभाषा । अत एव कथ्यते पण्डितैः “ भारतस्य द्वे प्रतिष्ठे संस्कृतं संस्कृतिस्तथा ” इति ।

संक्रियतेऽनयेति व्युत्पत्त्या मानवस्य समाजस्य वान्तरिकविकाससूचकशब्दोऽत्र संस्कृतिः । यथा सभ्यताशब्देन भौतिको विकासः संसूच्यत एवमेव संस्कृतिपदेन पुनराध्यात्मिकानां विचाराणां, धार्मिकानां भावानाम् दार्शनिकस्य ज्ञानस्य, सत्साहित्यस्य, ललितकलानां वैशिष्ट्यस्य, शौचाचाराणाम्, जीवनादर्शनाञ्चोत्कर्षो गृह्यते ।

भारतीया संस्कृतिस्तु विश्वसंस्कृतिषु श्रेष्ठा प्रेष्ठा वदान्या सनातना चिरन्तना च वर्तते । उक्तिस्तु- **भारतस्य द्वे प्रतिष्ठे संस्कृतं संस्कृतिस्तथा** । विश्वस्य सर्वे देशाः यदा अज्ञानान्धकारे निमग्नाः असभ्याः असंस्कृताश्चावर्तन्त, आचारव्यवहाराणां नामापि नाजानन्त, स्वार्थसाधनमेव जीवनलक्ष्यमन्यन्त तदा भारतीयाः **परस्परं भावयन्तः योगक्षेममवाप्स्यथ** । “**सर्वे भवन्तु सुखिनः**” अन्वतिष्ठन् । मनुना एतदर्थमेव साभिमानम् उद्घोषितम्-

**एतद्देशप्रसूतस्य सकाशादग्रजन्मनः । स्वं स्वं चरित्रं शिक्षेर्न् पृथिव्यां सर्वमानवाः ॥**

भारतीया संस्कृतिस्तु देवपरायणा वर्तते । सर्वमेव- “**यत्करोषि यदश्रासि यज्जुहोषि ददासि यत् । यत्तपस्यसि कौन्तेय तत्कुरुष्व मदर्पणम् ॥**” कायजातं देवार्पणभावनया कुर्वन्तो भारतीयाः किमप्यसन्नानुतिष्ठन्ति । आत्मवत्सर्वभूतेषु व्यवहरन्तो भारतीयाः कस्याप्यहितं न कुर्वन्ति । तदुररीकृत्य जोघुष्टं

केनापि सता - अष्टादशपुराणेषु व्यासस्य वचनद्वयम् । परोपकारः पुण्याय पापाय परपीडनम् ॥  
 भारतीया संस्कृतिस्तु धर्ममूला वर्तते । श्रूयते च महानारायणोपनिषदि- **धर्मो विश्वस्य जगतः प्रतिष्ठा, धर्मेण**  
**पापमपनुदति, लोके धर्मिष्ठं प्रजा उपसर्पन्ति ।** भारतीयाः ऐहलौकिकमभ्युदयं पारलौकिकं श्रेयसञ्च  
 समकालमेव गृह्णन्ति । धर्मलक्षणञ्चास्त्येवम्- **यतो अभ्युदयनिःश्रेयसः सिद्धिः स धर्मः ।** धर्ममूलेषु  
 पुरुषार्थचतुष्टयेषु लौकिकोपभोगस्यात्मकल्याणस्य च विलक्षणः समन्वयो विद्यते । आचारं निर्दिशति  
 गीतोक्तिः- **स्वधर्मे निधनं श्रेयः परधर्मो भयावहः ।** भारते तु जीवनस्य प्रथमश्वासतोऽन्तिमश्वासपर्यन्तम्  
 मानव्यवहारो धर्मनियन्त्रितो वर्तते । यतो हि **आचारहीनं न पुनन्ति वेदाः** इत्युदीरितं सद्भिः ।

कर्मायत्तं फलं पुंसां सुखदुःखादिकञ्चेति मन्यतेऽत्र संस्कृत्याम् । तच्च श्रूयते पुराणे-**तत्फलं भुज्यते**  
**चैव भोगभूमिष्वनुक्रमात् । भारते तु कृतं कर्म शुभं वा शुभमेव च ॥** इह जन्मनि जन्मान्तरे स्वर्गे, नरके,  
 भूतले वा नानाविधयोनिषु परिभ्रमणेऽपि कर्माणि न परित्यजन्ति कर्तारम् । विश्वासेनानेन भारतीयसमाजे  
 सदाचारस्य महती प्रतिष्ठा सञ्जातास्ति ।

सहिष्णुता हि सा तपश्चर्यात्मदमनञ्च सन्ति बहवो गुणा स्पृहणीया अस्याः भारतीयाया संस्कृत्याः ।  
 रङ्गनाथशर्मवर्येण एकचक्रम् - नामकरूपके धर्मराजमुखेन स्पष्टीक्रियते यत्- **सत्यं माता पिता ज्ञानं धर्मो**  
**भ्राता दया सखा । शान्तिः पत्नी क्षमा पुत्रः षडेते मम बान्धावाः ॥** अत्र तितिक्षा धर्मावयवभूतास्ति ।  
 भारतीयाः उदात्तवृत्तयः वसुधैव कुटुम्बकमिति भावनया सम्मिलित्वा आनन्देन परस्परं भावयन्ति जीवन्ति च ।  
 उपदेशो हि- **अयं निजः परो वेति गणना लघुचेतसाम् । उदारचरितानान्तु वसुधैव कुटुम्बकम् ।**  
 भूतलप्राणिषु कुटुम्बभावना परमश्लाघ्या विशिष्टता वर्तते । सर्वेषामेव प्राणिनामार्तिनाशनं, स्वार्थान् परित्यज्य  
 परार्थघटनं, स्वार्थो यस्य परार्थ एव सः नृणामग्रणी इति धारणा, **तेन त्यक्तेन भुञ्जीथाः** विश्वासोऽयम् इत्येतानि  
 भारतीयायाः सस्कृत्याः अवयवभूतानि सन्ति ।

भारतीयाः त्यागवृत्त्या आत्मसुखनिरपेक्षतया श्रमप्रवृत्ताः सेवाधर्ममनुतिष्ठन्तोऽद्यापि विश्वं  
 विस्मयविमुग्धमेव कुर्वन्ति । **न कर्मणा न प्रजया धनेन त्यागेनैकेऽमृतत्वमानशुः** इति हि  
 तैत्तिरीयारण्यकोपनिषद्वाक्यम् । **एकं सद्भिप्रा बहुधा वदन्ति** इत्युक्तिरिव सर्वे एव स्वाभिमतं पन्थानमनुसर्तुं  
 स्वतन्त्राः यतोऽत्र सम्यग्ज्ञातमस्ति यथा ऋजुकुटिलनानापथजुषां नदीनां गम्यो जलनिधिरस्ति, एवमेव  
 विविधाभिः उपासनापद्धतिभिरेको जगदीश्वर एवाराध्यते । तथा हि वेदमन्त्रः-**विश्वतश्चक्षुरुत विश्वतोमुखो**  
**विश्वतो हस्त उत विश्वतस्पात् । सम्बाहुभ्यां नमति सम्पतत्रैर्द्यावापृथिवी जनयन् देव एकः ॥** एवमपि  
 श्रूयते - **आकाशात्पतितं तोयं यथा गच्छति सागरम् । सर्वदेव नमस्कारः केशवं प्रतिगच्छति ॥** अत्र तु

अश्रीमच्छध्वं भारताः, अमृतं वा आपः, नाप्सु मूत्रपुरीषं कुर्यात् न निष्ठीवेत् न विवसनस्त्रायात्

इन्द्रियनिग्रहः- मम्मटस्य काव्यप्रकाशे- जितेन्द्रियत्वं विनयस्य कारणं गुणप्रकर्षो  
विनयादवाप्यते । गुणाधिके पुंसि जनोऽनुरज्यते जनानुरागप्रभवा हि सम्पदः ॥

सत्यम्- तैत्तिरीयोपनिषदः शिक्षावल्याम्- सत्यं वद धर्मं चर स्वाध्यायान्मा प्रमदः ।

अक्रोधः- गीतायाम्- क्रोधाद्भवति सम्मोहः सम्मोहात्स्मृतिविभ्रमः । स्मृतिभ्रंशात् बुद्धिनाशः  
बुद्धिनाशात् प्रणश्यति ॥

भारतीयसंस्कृतेर्विलक्षणं गुणमस्ति समन्वयभावना, सारग्रहणं वा । ऋग्वेदे- **सद्गच्छध्वं संवदध्वम्**  
**सं वो मनांसि जानताम्** । **“समानेन वो हविषा जुहोमि”** । भारतीयाः हंसवत् सर्वत्रैव सारं गृहीतुमसारं  
व्यक्तुञ्च सर्वदैव सयत्नाः वर्तन्ते । अद्य तु यदस्याः कमनीयमाह्लादकं सजीवञ्च रूपं दृष्टिपथमायाति तच्च  
समन्वयभावितमेव वर्तते ।

भारतीयसंस्कृत्यां कामार्थो समुपेक्षितौ न स्तः । मनुस्मृतौ- **प्रथमे नार्जिता विद्या द्वितीये नार्जितं**  
**धनम् । तृतीये नार्जितो धर्मः चतुर्थे किं करिष्यति** ॥ गृहस्थानामनिवार्यतयोपभोग्यौ एवाख्यातौ वर्तते  
कामार्थो । परमेतौ एवं नियन्त्रितौ यथा तयोरतिधर्ममोक्षवाधिका न भवेत् । एवमेषा भारतीया संस्कृतिः  
सन्तुलितं जीवनमेवोपस्थापयति ।

भारतीया संस्कृतिः स्वोदात्तगुणैर्विश्वजनीना मानवानामभ्युदयनिश्रेयससाधनामूला चास्ति । अद्य तु  
मनोमालिन्यग्रस्ताय विश्वाय संस्कृतिरेषाश्रयणीया वर्तते । अनयैव मनुष्यस्य मनस्तापः नश्यति सन्तोषादयो  
पुनः जीवनं सुखमयञ्च भविष्यति । विश्वकल्याणाय संस्कृतिरेषानुवर्तिता सुखप्रसारिका भविष्यतीति नात्र  
सन्देहः । गीतायाः तृतीयेऽध्याये- **यद्यदाचरति श्रेष्ठः तत्तदेवेतरो जनः । स यत्प्रमाणं कुरुते**  
**लोकस्तदनुवर्तते** । सनातनाध्यात्मप्रधानसंस्कृतेरस्याः अनुसरणेन भारतं विश्वगुरुरेव भूतभविष्यद्वर्तमाने ।

**सर्वे भवन्तु सुखिनः सर्वे सन्तु निरामयाः सर्वे भद्राणि पश्यन्तु मा कश्चिद्दुःखभाग्भवेत् ॥**

# ಲಘುಕ್ರಿಯಾಪದಸಂಗ್ರಹ:

ನಿತ್ಯ ಬಳಕೆಯ ಪ್ರಸಿದ್ಧ ಕ್ರಿಯಾಪದಗಳ ಸಂಗ್ರಹ :

ಡಾ. ತಿರುಮಲ:



ಮೈತ್ರಿ ಸಂಸ್ಥೆ-ಸಂಸ್ಥೆ ಪ್ರತಿಷ್ಠಾನಮ್ (೨)

ಬೆಂಗಳೂರು

ಲಘುಕ್ರಿಯಾಪದಸಂಘ್ರಹ: ನಿತ್ಯ ಬಳಕೆಯ ಪ್ರಸಿದ್ಧ ಕ್ರಿಯಾಪದಗಳ ಸಂಗ್ರಹ :  
ಡಾ. ತಿರುಮಲ, ಸಂಸ್ಕೃತ ಉಪನ್ಯಾಸಕರು.

ಪ್ರಕಾಶಕರು : ಮೈತ್ರೀ ಸಂಸ್ಕೃತ-ಸಂಸ್ಕೃತಿ ಪ್ರತಿಷ್ಠಾನಮ್ (೦)

#130, 3rd Main, 2nd Stage, Grihalakshmi Layout, Kamalanagar, Bangalore-79

ಮೊಬೈಲ್ : 94482 43724, 98867 34250

ಮೈಲ್ : mythreefoundation@gmail.com

**You Tube** : Mythree Samskritha Samskrithi Prathistanam

ಪುಟಗಳು : 68

ಪ್ರತಿಗಳು : 1000

ಕೃತಿಸ್ವಾಮ್ಯ : ಮೈತ್ರೀ ಸಂಸ್ಕೃತ-ಸಂಸ್ಕೃತಿ ಪ್ರತಿಷ್ಠಾನಮ್ (೦)

ಮುದ್ರಣಮ್ : Hariom Printers & Publishers, Chamrajpet, Bangalore

## ಲಘುಕ್ರಿಯಾಪದಸಂಘ್ರಹ:

### ವಿಷಯಾನುಕ್ರಮಣಿಕಾ

ವಿಷಯ:	ಪೃಷ್ಠಸಂಖ್ಯೆ
೧. ಮಾಹೇಶ್ವರಸೂತ್ರಾಣಿ	5
೨. ಭಾಷಾ, ಧಾತುವಿಚಾರ:	6
೩. ಗಣಶ: ವಿಕರಣಪ್ರತ್ಯಯಾ:	7-9
೪. ಲಕಾರವಿಚಾರ:	9-11
೫. ತಿಙ್ಪ್ರತ್ಯಯವಿಚಾರ:	12-14
೬. ಪುರುಷ-ವಾಚ್ಯವಿಚಾರ:	14-16
೭. ಪ್ರತ್ಯಯವಿಚಾರ:	16-20
೮. ಭಾವಕರ್ಮ-ಣಿಚ್-ಸನ್-ಯಙ್-ಯಙ್‌ಲುಗಂತಾ:	20-23
೯. ಕ್ರಿಯಾಪದರೂಪಾಣಿ-ಭೂ-ಧಾತು:-ಸರ್ವರೂಪಾಣಿ	23-37
೧೦. ಖಾದ್-ಇತ್ಯಾದಿಧಾತುರೂಪಾಣಿ	37-68

## ಲಘುಕ್ರಿಯಾಪದಸಂಗ್ರಹ:

ओं नमो शब्दविद्यासम्प्रदायकर्तृभ्यो नमो महद्भ्यो नमो गुरुभ्यः



नृत्तावसाने नटराजराजो ननाद ढक्कां नवपञ्चवारम् ।

उद्धर्तुकामः सनकादिसिद्धानेतद्विमर्शो शिवसूत्रजालम् ॥

ಸನಕಾದಿಸಿದ್ಧಪುರುಷರನ್ನು ಉದ್ಧರಿಸುವ ಇಚ್ಛೆಯಿಂದ ನಟರಾಜರಾಜನಾದ  
ಮಹೇಶ್ವರನು ನೃತ್ಯದ ಅಂತಿಮಸಮಯದಲ್ಲಿ ಹದಿನಾಲ್ಕು ಸಲ ಡಮರುವನ್ನು ನುಡಿಸಿ  
ಶಿವಸೂತ್ರನಿಧಿಯನ್ನು ಅನುಗ್ರಹಿಸಿದನು. ಶಿವಸೂತ್ರವು ವೇದಕ್ಕೆ ಸಮಾನವಾಗಿರುವ  
ಕಾರಣ ಅಕ್ಷರಸಮಾಮ್ನಾಯವೆಂದು, (ವೇದ: = ಆಮ್ನಾಯ:) ಹದಿನಾಲ್ಕು  
ಸೂತ್ರಗಳಿರುವ ಕಾರಣ ಚತುರ್ಥಶಸೂತ್ರೀಯೆಂದು, ಮಹೇಶ್ವರನ ಅನುಗ್ರಹದಿಂದ  
ಪ್ರಪ್ತವಾದುದರಿಂದ ಮಾಹೇಶ್ವರಸೂತ್ರಾಣಿ ಎಂದೂ ಪ್ರಸಿದ್ಧವಾಯಿತು.

1. अ इ उ ण्	2. ऋ लृ क्	3. ए ओ ङ्	4. ऐ औ च्
5. ह य व र ट्	6. ल ण्	7. ञ म ङ ण न म्	
8. झ भ ञ्	9. घ ढ ध ष्	10. ज ब ग ड द श्	
11. ख फ छ ठ थ च ट त व्	12. क प य्	13. श ष स र्	14. ह ल्

येनाक्षरसमाम्नायमधिगम्य महेश्वरात् ।

कृत्स्नं व्याकरणं प्रोक्तं तस्मै पाणिनये नमः ॥

ಮಹೇಶ್ವರಪ್ರಸಾದದಿಂದ ಯಾರು ಅಕ್ಷರಸಮಾಮ್ನಾಯವೆಂದು ಪ್ರಸಿದ್ಧವಾದ  
ಮಹೇಶ್ವರಸೂತ್ರಗಳನ್ನು ತಿಳಿದು ಸಂಪೂರ್ಣ ವ್ಯಾಕರಣವನ್ನು ಬೋಧಿಸಿದರೋ  
ಅಂತಹ ಪೂಜ್ಯ ಪಾಣಿನಿಮಹರ್ಷಿಗೆ ನಮಸ್ಕಾರವು.

वाक्यकारं वररुचिं भाष्यकारं पतञ्जलिम् ।

पाणिनिं सूत्रकारञ्च प्रणतोऽस्मि मुनित्रयम् ॥

ಸೂತ್ರಕಾರರಾದ ಪಾಣಿನಿ, ವಾರ್ತಿಕಕಾರರಾದ ವರರಿಚಿ (ಕಾತ್ಯಾಯನ) ಮತ್ತು  
ಪಾತಂಜಲಿ ಈ ಮುನಿತ್ರಯರನ್ನು ವಂದಿಸುತ್ತೇನೆ.



6  
 भाष्यते इति भाषा । मानवः स्वाभिप्रायम् अन्येभ्यः भाषया स्पष्टतया  
 प्रापयति । जगति विद्यमानासु सहस्राधिकभाषासु संस्कृतभाषैव सर्वप्राचीना,  
 सम्पद्धरिता, नित्योपयुक्ता च भाषाणां मातृवत् सुशोभते । भाषा सर्वदा  
 वाक्यात्मिका भवति । वाक्यं नाम योग्यताकांक्षासत्तियुक्तः पदसमुच्चयः  
 शब्दसमूहो वा भवति । शब्दो नाम अर्थबोधको वर्णसमूहः भवति ।  
 रेखाविन्यासरीतिरेव वर्णः अथवा अक्षरमित्यभिधीयते । परं व्याकरणरीत्या  
 "सुमिडन्तं पदम्" (पाणिनेः सूत्रम् १/४/१४) इति । विभक्त्यनुसारं सुप्रत्ययान्तं  
 सुबन्तं, क्रियाबोधकं तिङ्प्रत्ययान्तं तिङन्तं पदं भवति । तिङन्तस्य अपरं  
 नामास्ति क्रियापदमिति । क्रियापदस्य मूलरूपं धातुः इति कथ्यते ।

धास्यल्लुಡುವಂತಾದ್ದು ಭಾಷೆ ಎನಿಸಿಕೊಳ್ಳುತ್ತದೆ. ಮಾನವನು ತನ್ನ ಅಭಿಪ್ರಾಯವನ್ನು  
 ಅನ್ಯರಿಗೆ ಭಾಷೆಯ ಮೂಲಕ ಸ್ಪಷ್ಟವಾಗಿ ತಿಳಿಸುತ್ತಾನೆ. ಪ್ರಪಂಚದಲ್ಲಿರುವ ಸಾವಿರಾರು  
 ಭಾಷೆಗಳಲ್ಲಿ ಸಂಸ್ಕೃತವು ಎಲ್ಲಕ್ಕಿಂತ ಪ್ರಾಚೀನವಾದ, ಸಾಹಿತ್ಯ-ವಿಜ್ಞಾನ-ವಿಚಾರಗಳಿಂದ  
 ಸಂಪದ್ಧರಿತವಾಗಿ ನಿತ್ಯೋಪ ಭಾಷೆಗಳ ಮಾತೃವಾಗಿ ಸುಶೋಭಿಸುತ್ತಿದೆ.  
 ಭಾಷೆಯು ಯಾವಾಗಲೂ ವಾಕ್ಯಾತ್ಮಕವಾಗಿರುತ್ತದೆ. ಅರ್ಥವನ್ನು ಭೋಧಿಸುವ  
 ಯೋಗ್ಯತೆ, ಕ್ರಿಯಾಪದದಿಂದ ಕರ್ತೃ-ಕರ್ಮಾದಿಗಳ ಆಕಾಂಕ್ಷಾಸಹಿತವಾದ,  
 ಪದಗಳನಿರಂತರತೆಯಿರುವ (ಪದೋಚ್ಚಾರಣೆಯಲ್ಲಿ ಕಾಲವ್ಯವಧಾನವಿಲ್ಲದ) ಪದಗಳ  
 ಸಮೂಹವು ವಾಕ್ಯವೆನಿಸುತ್ತದೆ. ಶಬ್ದವೆಂದರೆ ಅರ್ಥಭೋಧಕ ವರ್ಣಗಳ ಸಮೂಹ.  
 ರೇಖಾವಿನ್ಯಾಸರೀತಿಯೇ ವರ್ಣ ಅಥವಾ ಅಕ್ಷರ ಎಂದು ಹೇಳಲ್ಪಡುತ್ತದೆ. ಆದರೆ  
 ವ್ಯಾಕರಣದ ಪ್ರಕಾರ ವಿಭಕ್ತಿಗೆ ಅನುಸಾರವಾಗಿ ಅಂತ್ಯದಲ್ಲಿ ಸುಪ್-ಪ್ರತ್ಯಯದಿಂದ  
 ಕೂಡಿರುವ ಸುಬಂತ್ವ ಮತ್ತು ಕ್ರಿಯಾಭೋಧಕವು ಅಂತ್ಯದಲ್ಲಿ ತಿಜ್-ಪ್ರತ್ಯಯವುಳ್ಳ  
 ತಿಜಂತವು "ಪದ" ಎಂದು ಕರೆಯಲ್ಪಡುತ್ತದೆ. ತಿಜಂತಕ್ಕೆ ಕ್ರಿಯಾಪದವೆಂದು  
 ಇನ್ನೊಂದು ಹೆಸರು. ಕ್ರಿಯಾಪದದ ಮೂಲರೂಪ ಧಾತುವಾಗಿರುತ್ತದೆ.

"ಭೂದಯೋ ಧಾತವಃ" (ಪಾ.ಸು. १/३/१) ಕ್ರಿಯಾವಾಚಿನೋ ಭೂದಯೋ ಧಾತುಸಂಜ್ಞಾಃ  
 ಸ್ಯುಃ । ಪಾಣಿನೀಯ ಧಾತುಪಾಠೇ ದ್ವಿಸಹಸ್ರಾಧಿಕಾಃ (२०००) ಧಾತವೋ (Roots)  
 ವರ್ತಂತೇ । ಧಾತು-ತಿಟ್ಟಪ್ರತ್ಯಯಯೋಃ ಮಧ್ಯೇ ವಿಧಿಯಮಾನಾಃ ವಿಕರಣಪ್ರತ್ಯಯಾಃ ಕಥ್ಯಂತೇ ।  
 ವಿಕರಣಪ್ರತ್ಯಯಾಃ ದಶವಿಧಾಃ ಸಂಭವಂತಿ । ತेषಾಂ ಭೇದಮನುಸ್ಮತ್ಯ ಧಾತವಃ ದಶಸು ಗುಣेषು  
 ವಿಭಜ್ಯ ಪಠ್ಯಂತೇ ।

ಕ್ರಿಯಾವಾಚಿಗಳಾದ ಭೂ ಇತ್ಯಾದಿಗಳಿಗೆ ಧಾತು ಎನ್ನುವ ಸಂಜ್ಞೆ (ಹೆಸರು).  
 ಪಾಣಿನಿಮಹರ್ಷಿಗಳ ಧಾತುಪಾಠದಲ್ಲಿ ಎರಡುಸಾವಿರಕ್ಕಿಂತ ಹೆಚ್ಚಿನ ಧಾತುಗಳಿವೆ. ಧಾತು  
 ಮತ್ತು ತಿಜ್-ಪ್ರತ್ಯಯಗಳ ಮಧ್ಯದಲ್ಲಿರುವ ಪ್ರತ್ಯಯಗಳು ವಿಕರಣಪ್ರತ್ಯಯಗಳೆಂದು  
 ಕರೆಯಲ್ಪಡುತ್ತವೆ. ವಿಕರಣ ಪ್ರತ್ಯಯಗಳು ಹತ್ತು ವಿಧಗಳಾಗಿವೆ. ಅವುಗಳ ಭೇದಗಳನ್ನು  
 ಅನುಸರಿಸಿ ಧಾತುಗಳು ಹತ್ತು ಗಣಗಳಾಗಿ ಅಧ್ಯಯನ ಮಾಡಲ್ಪಡುತ್ತವೆ.

ಧಾತುಗಳ ಹತ್ತುಗಣಗಳ ಹೆಸರನ್ನು ಒಂದೇ ಶ್ಲೋಕದಲ್ಲಿ ಕ್ರೋಡಿಕರಿಸಿ  
 ಹೇಳಲಾಗಿದೆ.-

ಭ್ವಾಘದಾದೀ ಜುಹೋತ್ಯಾದಿ ದಿವಾದಿಃ ಸ್ವಾದಿರೇವ ಚ ।  
 ತುದಾದಿಶ್ಚ ರುಧಾದಿಶ್ಚ ತನಕ್ರಿಯಾದಿಚುರಾದಯಃ ॥

ತಥಾ ಹಿ- ಧಾತುಗಳ ಹತ್ತು ಗಣಗಳ ಹೆಸರು, ವಿಕರಣ ಪ್ರತ್ಯಯಗಳು ಮತ್ತು  
 ಪರಸ್ಥ-ಆತ್ಮನೇಪದ ಕ್ರಿಯಾಪದಗಳ ಉದಾಹರಣೆಗಳು ಇಂತಿವೆ-

१. "ಕರ್ತರೀ ಶಪ್" (ಪಾ.ಸು. ३/१/६८) ಭ್ವಾದಿಭ್ಯಃ ಶಪ್ (ಅ) ವಿಕರಣಃ ವಿಧಿಯತೇ।  
 ಭವತಿ, ವಂದತೇ ।

ಪಾಣಿನಿಸೂತ್ರಾನುಸಾರ ಭ್ವಾದಿಗಣದ (ಭೂ+ಆದಿ) ಧಾತುಗಳಿಗೆ ಕರ್ತೃ ಪ್ರಯೋಗದಲ್ಲಿ  
 "ಶಪ್"-ವಿಕರಣಪ್ರತ್ಯಯವು ವಿಧಿಸಲ್ಪಡುತ್ತದೆ. ಶಪ್-ಪ್ರತ್ಯಯದಲ್ಲಿ ಶಕಾರವು ಮತ್ತು  
 ಅಂತಿಮ ಅನುಬಂಧ ಪಕಾರವು ಲೋಪವಾಗುತ್ತದೆ. ಕೇವಲ ಅಕಾರ ಉಳಿಯುತ್ತದೆ.  
 ಅನಂತರ ತಿಜ್-ಪ್ರತ್ಯಯಗಳಲ್ಲಿ ಪರಸ್ಥಪದಿ ಧಾತುಗಳಿಗೆ ತಿಪ್-ಪ್ರತ್ಯಯಗಳು ಅಂತ್ಯದಲ್ಲಿ  
 ವಿಧಿಸಲ್ಪಡುತ್ತವೆ. ಆತ್ಮನೇಪದಿ ಧಾತುಗಳಿಗೆ ತಜ್-ಪ್ರತ್ಯಯವು ವಿಧಿಸಲ್ಪಡುತ್ತದೆ.

ಉದಾಹರಣೆಗೆ ಭೂ-ಧತುವಿಗೆ ಪ್ರಥಮಪುರುಷ ಏಕವಚನದಲ್ಲಿ ತಿಪ್ ಪ್ರತ್ಯಯ  
 ವಿಧಿಸಿದಾಗ, ತಿಪ್-ಪ್ರತ್ಯಯದಲ್ಲಿ ಅಂತಿಮ ಅನುಬಂಧ ಪಕಾರವು ಲೋಪವಾಗುತ್ತದೆ.  
 ಅನಂತರ ಗುಣ, ಅವಾದೇಶಾದಿ ಪ್ರಕ್ರಿಯೆಗಳಿಂದ ಕ್ರಿಯಾಪದದ ಸಿದ್ಧಿಯಾಗುತ್ತದೆ.  
 ಹೀಗೆ ವಿವಿಧ ಪ್ರಕ್ರಿಯೆಗಳನ್ನು ತಿಳಿಯಬೇಕು.

ಭೂ+ಶಪ್+ತಿಪ್ = ಭೂ+ಅ+ತಿ = ಭೂ+ಅ+ತಿ = ಭವತಿ ।

२. "ಅದಿಪ್ರಭೃತಿಭ್ಯಃ ಶಪಃ" (ಪಾ.ಸು. २/४/७२) ಅದಾದಿಭ್ಯಃ ಶಪಃ ಲುಕ್ । ಅತ್ತಿ,  
 ಆಸ್ತೇ ।



## शुभाशंसनानि

इन्द्रचन्द्रकाशकृत्स्नेत्याद्यष्टव्याकरणानि संस्कृतभाषायां वर्तन्त इति वयं सर्वे जानीमः । किञ्च भरतभूमौ विविधराज्येषु भिन्नरीत्या संस्कृतभाषासम्बद्धा व्याकरणाध्ययनपद्धतिरस्तीति ज्येष्ठैरेतज्जायते । तेषु व्याकरणेषु पाणिनीयं व्याकरणं सर्वसम्मतं प्रचुरेण अध्ययने प्रसिद्धञ्चास्ति ।

संस्कृतस्य प्रारम्भिकाध्येतृन् निमित्तीकृत्य डा. तिरुमलेन कृतं लघुक्रियपदसङ्ग्रहः नामकपुस्तकरचनम् उत्तमकार्यमस्ति । संस्कृतव्याकरणे तिङन्तानि अत्यन्तप्रधानानि । तेषाम् अध्ययनार्थं समय-प्रयत्नयोः आधिक्यात् अध्ययनस्य आरम्भे विद्यार्थिनः काठिन्यमनुभवन्ति । अतः प्रसिद्धक्रियापदानां सुलभतया अध्ययनार्थं लिखिता एषा पुस्तिका सर्वप्रयोजनं भवतु इति ससन्तोषम् आशासे ।

शुभम्

डा. विद्वान् वेङ्कटेशभट्टः  
श्री माता संस्कृतमहापाठशाला उम्मच्चि,  
यल्लापुर- उत्तरकन्नडमण्डलम्

ನಿಮ್ಮ ಸಂಸ್ಕೃತ ಕಲಿಕೆಗೆ ಸಹಕಾರಿಯಾದ ನಮ್ಮ ಹೆಮ್ಮೆಯ ಪ್ರಕಟಣೆಗಳು

- |                       |                       |                       |
|-----------------------|-----------------------|-----------------------|
| 1. ಸಂಸ್ಕಾರ ಸುಗಂಧಃ     | 2. ಸಂಸ್ಕೃತಗುರುಕುಲಮ್-1 | 3. ಸಂಸ್ಕೃತಗುರುಕುಲಮ್-2 |
| 4. ಸಂಸ್ಕೃತಗುರುಕುಲಮ್-3 | 5. ಸಂವಾದಶತಕಮ್         | 6. ನೀತಿಶತಕಮ್          |
| 7. ಶಬ್ದಚಂದ್ರಿಕಾ       | 8. ಅಮೃತಭಾಷಿತಮ್        | 9. ಅಮರಕೋಶಃ            |
| 10. ರಸಬಿಂದು           | 11. ಕ್ರಿಯಾಪದಕೋಶಃ      | 12. ಗೀತಾಮೃತಮ್         |

ಈ ಪುಸ್ತಕಗಳು ತಮಗೆ ಬೇಕಾದಲ್ಲಿ ದಯವಿಟ್ಟು 9740855248 ಸಂಖ್ಯೆಗೆ ವಾಟ್ಸಪ್ ಮೂಲಕ ನಿಮ್ಮ ವಿಳಾಸವನ್ನು ಕಳಿಸಿಕೊಡಿ.

ಅಮರಕೋಶ ತರಗತಿ, ನಿರಂತರಸುಭಾಷಿತ, ಭಗವದ್ಗೀತೆ ಹಾಗೂ ಸಂಸ್ಕೃತ ಕಲಿಕೆಯ ವಿಡಿಯೋಗಳಿಗಾಗಿ ನಮ್ಮ Mythree Samskritha Samskrithi Pratishtanam ಯೂಟ್ಯೂಬ್ ಚಾನಲ್ ಗೆ ಭೇಟಿನೀಡಿ.



राष्ट्रहिताय संस्कृतम्



रजतोत्सवः

# The International Conference On "Dharma, Dharmasāstra and Culture"

17<sup>th</sup> – 18<sup>th</sup> August 2022

## शोधरत्नम्

अन्ताराष्ट्रीय-परिषदि समर्पितानां शोधपत्राणां सारसङ्ग्रहः

### Chief Editors

**Dr. Kala Acharya**

Executive President  
SSASP, Mumbai

**Prof. Madhusudan Penna**

Vice Chancellor (I/C),  
Kavikulaguru Kalidas Sanskrit University, Ramtek

Organized by

**Kavikulaguru Kalidas Sanskrit University, Ramtek**

(Accredited with A+ Grade by NAAC)

**Bharatratna Dr. Panduranga Vaman Kane  
Sanskrit Adhyayan Kendra**

**Ratnagiri Sub-Centre**

In association with



R.E. Society's  
Gogate Jogalekar College,  
Ratnagiri



Siddhant Knowledge  
Foundation



Sanskriti Sanvardhan &  
Sanshodhan Pratishthan,  
Mumbai

**ISBN No. -**

978-93-92938-24-5

**Published by:**

**Dr. Ramachandra Joshi**  
Registrar, KKSU, Ramtek

**Editors :**

**Chief Editor:**

**Prof. Madhusudan Penna**  
Hon'ble Vice Chancellor (I/C)

**Editors :**

**Dr. Dinakar Marathe**  
Director, KKSU, Ratnagiri Sub Cent.

**Dr. Kalpana Athalye**  
Head, Dept. of Sanskrit, GJC, Ratnagiri

**Editorial Board:**

**Dr. Shinde Manoj Angad**

**Miss. Kashmira Dali**

**Shri. Avinash Chavan**

**Shri. Aashish Aathavale**

**Advisory Committee of International Conference**

**Prof. Shrinivasa Varakhedi**, Hon'ble VC, CSU, New Delhi.

**Shri. Dilip Karambelkar**, President, SSASP, Mumbai.

**Shri. Adinath Patil**, Secretary, SSASP, Mumbai.

**Smt. Shilpatai Patwardhan**, Executive President, Ratnagiri  
Education Society, Ratnagiri.

**Dr. Kala Acharya**, Executive President, SSASP, Mumbai.

**Dr. Prafulladatta Kulkarni**, Principal (I/C), Gogate Jogalekar  
College, Ratnagiri.

**Dr. Ramchandra Joshi**, Registrar, KKSU, Ramtek.

**Prof. Prasad Gokhale**, Director, BPD, KKSU, Ramtek

35	Siddhi Kolekar	Dharmavyadh Gita	
36	Neeraja Sheth	Raising responsible citizens : Insights on parenting from ancient India	
37	Priyadarshini Ghosh Shome, Sandhya Purecha	Dharma and Rituals in Performance	
38	Shraddha Devpoojari, Vijay Kumar C. G.	Nature of Dharma according to Sadhana-Panchakam	38
39	Kokila Kalekar	Mahamahopadhyaya P. V. Kane's Historiography as Translation Studies and Cultural Heritage	34
40	Dhanashree Shejwalkar	Dharma and Culture as Reflected in Vatsagulmamāhātmya	36
41	Rajshree Meshram, Priyanka Kewalramani	Importance of Indian Culture outside India	37
42	हेडगे-तिरुमलः	संस्कृतसाहित्ये धर्मः संस्कृतिश्च।	38
43	बनवि-शिवानन्दः , वि. गिरिश्चन्द्रः	संस्कृतसाहित्ये धर्मः संस्कृतिः च।	38
44	अस्रण्ण- श्रीहरिनारायणदासः	यक्षगानकलायां धर्मशास्त्रीयविचाराः	39
45	गिरिगद्दे-चन्द्रकान्द्रः	सांस्कृतिकदृष्ट्या शैक्षिकपुनारचना।	40
46	कपिलदेवः शास्त्री	धर्मशास्त्रे सामाजिक व्यवस्था ।	40
47	रामकृष्णः	धर्मस्वरूपम् ।	41

## संस्कृतसाहित्ये धर्मः संस्कृतिश्च

हेडगे-तिरुमलः

भारतभूमिरियं कर्मभूमिर्धर्मभूमिस्तपोभूमिश्च।  
महासागरयोर्मध्ये विद्यमानायामस्यां पुण्यकर्मभूमौ विराजते आर्षपरम्परान्विता  
भारतीसन्ततिः। सन्ततिरेषा सम्भाषते संस्कृतादिविविधभाषाः सुखेन जीवति च  
सम्पर्कसाधनीभूतभाषासु मुख्या मधुरा दीव्या गीर्वाणभारतीत्यादिनाम्ना प्रसिद्धा  
प्राचीना च संस्कृतभाषा। अतः एव कथ्यते पण्डितैः - 'भारतस्य द्वे प्रतिष्ठे  
संस्कृतस्संस्कृतिस्तथा' इति। भरतखण्डे मन्त्रद्रष्टारः महर्षयः वेदार्थविज्ञाः सन्तः  
इहपरलोकसुखसाधने च सर्वेषां मार्गदर्शकाः भारतीयसंस्कृतेः प्रमाणभूतस्य वेदस्य  
सर्वस्य सारभूतः धर्मः इति प्रत्यपादयन् 'वेदोऽखिलो धर्ममूलम्' इति।

अस्माकं भारतवर्षे प्रचूरग्रन्थसम्पदा वर्तते तत्र तत्र धर्मः संस्कृतिश्च  
विभिन्नप्रकारैर्बोध्यते। किन्तु अस्मिन् शोधपत्रे मुख्यत्वेन संस्कृतसाहित्यशास्त्रम-  
ङ्गीकृत्य धर्मस्तथा संस्कृतिः अत्र सप्रमाणं निरूप्यते।

मुख्यशब्दाः - धर्मः, संस्कृतिः, संस्कृतसाहित्यम्।

## संस्कृतसाहित्ये धर्मः संस्कृतिः च

बनवि-शिवानन्दः,

वि. गिरिश्चन्द्रः

भारतीयसाहित्येषु अत्यन्तप्राचीनतमं साहित्यं संस्कृतसाहित्यं विद्यते।  
वैदिकसाहित्येन सह संस्कृतसाहित्यमपि आरब्धम्। धर्मस्य मूलं वेदः। अयं वेदः  
जाति-मत-पन्थ-देशसीमाम् अतिरिच्य समस्तमानवकोटिं प्रति ज्ञानप्रदायकः,  
प्राचीनसाहित्यं वर्तते। वेदो नाम ज्ञानमित्यर्थः। अस्य उद्देशः तावत्  
अत्यन्तपरिशुद्धं ज्ञानं समग्रजगति सर्वत्र प्रसरणमेव अस्ति। वेदः न  
केनाप्याचार्येण बोधितः विद्यते, अपि तु महर्षिभिः सहस्रवर्षेभ्यः  
कृततपःप्रभावात् साक्षात्कृतज्ञानराशिः विद्यते।

मुख्यशब्दाः - धर्मः, संस्कृतिः, संस्काराः, वेदाः, साहित्यविद्या।



Rajajinagar Education Society's

**SRI AUROBINDO COLLEGE**

Affiliated to Bangalore University & NAAC Accredited B+  
#6/c, 5<sup>th</sup> Main, Dr M.C.Modi Road, Mahalakshmpuram, Bengaluru-86  
www.sriarobindocollege.ac.in Ph: 080-23492449



**A ONE DAY NATIONAL SEMINAR**  
on  
**"PORTRAYAL OF INDIAN  
CULTURE IN LITERATURE"**

**15 July 2022**

organised by

**Departments of Languages**

in Association with

**Internal Quality Assurance Cell**

**Copy Right - 2022**  
**ISBN No - 978-93-85291-13-5**

**Publishers Address**

**EnkayBooks & Infotech**  
**#209, Harisadan, 20 Ansari Road, New**  
**Delhi - 110002**



Prof. H.S. Venkateshwarlu  
Poet, Writer, Translator

(ಸಂಸ್ಕೃತ ವಿಭಾಗ)

ಲೇಖಕರ ಹೆಸರು

ಪ್ರಬಂಧದ ಶೀರ್ಷಿಕೆ

ಕ್ರಮ ಸಂಖ್ಯೆ	ಪ್ರಬಂಧದ ಶೀರ್ಷಿಕೆ	ಲೇಖಕರ ಹೆಸರು
32	ಸುಭಾಷಿತೇಷು ನಿಹಿತಂ ಭಾರತೀಯಾ ಸಂಸ್ಕೃತಿ	ಶ್ರೀಮತಿ. ಭಾಮತಿ ಭದ್ರ
33	ವೇದಪುರಾಣಮಹಾಕಾವ್ಯಾದಿಪು ಭಾರತೀಯಸಂಸ್ಕೃತೇ: ಚಿತ್ರಣಮ್	ಶ್ರೀ. ಗಣಪತಿ ಭದ್ರ:
34	ಇತಿಹಾಸ ಪುರಾಣೇಷು ವೈರುಧ್ಯಾನಾಂ ಪರಿಹಾರೋಪಾಯಾ:	ಶ್ರೀ. ಡಾ. ಎಂ.ಜಿ.ನಂದನ ರಾವ:
35	ಕಾವ್ಯಶಿಖಾರ್ಥನಾರ್ಥಮ್ ಅಲಂಕಾರಾಗಾಮ್, ಅಲಂಕಾರಶಾಸ್ತ್ರ ಗ್ರಂಥಾನಾಂ ಯೋಗದಾನಮ್	ಶ್ರೀ. ಎನ್.ಆರ್.ವಾಹಲೀಕ ರಾವ
36	ರಾಜಶೇಖರಕೃತ ಕಾವ್ಯಮಿಮಾಂಸಾಯಾಂ ಭಾರತೀಯ ಸಂಸ್ಕೃತಿ:	ಶ್ರೀಮತಿ. ಡಾ. ಪದ್ಮಾವತಿ ಎಂ. ಸಿಡ್ಡಿಗಾರಿ
37	ಸಂಸ್ಕೃತ ಸಾಹಿತ್ಯೇ ಭಾರತೀಯ ಸಂಸ್ಕೃತೇ: ಚಿತ್ರಣಮ್	ಶ್ರೀ. ಶಿವರಾಮ ಗುಪ್ತ ವಿ.
38	ಸುಂದರಕಾಂಡೇ ಸಮೃದ್ಧಿಸಿತಾನಿ ಮಾನವೀಯ ಮೌಲ್ಯಾನಿ	ಶ್ರೀ. ಡಾ. ಶ್ರೀಕೃಷ್ಣ ಎಚ್. ಕಾಕುಂಡಕಿ
39	ಹರಿವಂಶಪುರಾಣೇ ಸಂಸ್ಕೃತೇ: ನಿರೂಪಣಮ್	ಶ್ರೀ. ಶ್ರೀನಿಧಿ ಅಭಯಚಂದ್ರ:
40	ವೇದ ಪುರಾಣ ಮಹಾಕಾವ್ಯಾದಿಪು ಭಾರತೀಯ ಸಂಸ್ಕೃತೇ: ಚಿತ್ರಣಮ್	ಶ್ರೀ. ಡಾ. ತಿರುಮಲ ಹೇಗಡೆ
41	ಸಂಸ್ಕೃತಸಾಹಿತ್ಯೇಷು ಭಾರತೀಯ ಸಂಸ್ಕೃತೇರಂಗಭೂತಂ ಶಿಕ್ಷಣಮ್	ಶ್ರೀ. ವಾದಿರಾಜ:
42	ಗೀತಾರ್ಥ ವಿವರಣ ಪ್ರತಿಪಾದಿತ ಜೀವನ ನಿರ್ವಹಣ ಸ್ವಾಧೀನ	ಶ್ರೀ. ವಿನಯ ಕುಮಾರ:
43	ವೇದಾಂತೇಷು ಪ್ರಸ್ಥಾನತ್ರಯಭಾಷ್ಯಾಣಿ	ಶ್ರೀ. ರಾಮಚಂದ್ರ ಎನ್.ಯು
44	ಭಾರತೀಯ ವೈದ್ಯಪದ್ಧತಿಯಲ್ಲಿ ಆಹಾರ ಸಂಸ್ಕೃತಿ	ಶ್ರೀಮತಿ. ಡಾ. ಅಂಜನಾ ಮಠದ
45	ಸಂಸ್ಕೃತ ಗ್ರಂಥಗಳಲ್ಲಿ ಸಂಸ್ಕೃತಿಯ ಅನಾವರಣ	ಶ್ರೀಮತಿ. ಡಾ. ದೀಪಶ್ರೀ ಎಸ್.
46	ಕಾವ್ಯ ಶೋಭೆಯನ್ನು ಹೆಚ್ಚಿಸುವಲ್ಲಿ ಅಲಂಕಾರಗಳು.	ಶ್ರೀ. ದ್ವಾರಕೀಶ ಎಂ
47	ಅಲಂಕಾರಶಾಸ್ತ್ರಕ್ಕೆ ರುದ್ರಚಂದ್ರನ ವಿಶಿಷ್ಟ ಯೋಗದಾನ	ಶ್ರೀ ಕೆ.ಕೃಷ್ಣಮೂರ್ತಿ ಮಯ್ಯ
48	ರಾಮಾಯಣದ ಆದರ್ಶ ಪಾತ್ರಗಳು ತಿಳಿಸುವ ಜೀವನ ಮೌಲ್ಯಗಳು	ಶ್ರೀಮತಿ. ಡಾ.ಮೃತೇಯಿ ಎಚ್. ಎಲ್
49	ಸಂಸ್ಕೃತ ಸಾಹಿತ್ಯದಲ್ಲಿ ಭಾರತೀಯ ಸಂಸ್ಕೃತಿಯ ಚಿತ್ರಣ	ಶ್ರೀ. ನಾಗೇಶ ಎಸ್. ಡೊಂಗಾರಿ
50	ವೇದ - ಪುರಾಣ - ಮಹಾಕಾವ್ಯಗಳಲ್ಲಿ ಭಾರತೀಯ ಸಂಸ್ಕೃತಿಯ ಚಿತ್ರಣ	ಶ್ರೀ. ಪೂರ್ಣಪ್ರಜ್ಞಾಪಾರ್ಥಿ ಸಿ ಮಳಗಿ
51	ವೇದ ಪುರಾಣ ಮಹಾಕಾವ್ಯಾದಿಪು ಭಾರತೀಯ ಸಂಸ್ಕೃತೇ: ಚಿತ್ರಣಮ್	ಶ್ರೀ. ಶಿವಾನಂದ ಎಲ್ ಬಿ
52	ಭಾರತೀಯ ಸಂಸ್ಕೃತಿಯಲ್ಲಿ ಆದರ್ಶಗಳು	ಶ್ರೀ. ಶ್ರೀಶ ಪಾವಂಜಿ
53	ಶ್ರೀ ರಾಮಾಯಣ , ಮಹಾಭಾರತ ನಾಟಕಾದೀಪು ಸಂಸ್ಕೃತಿ	ಶ್ರೀ. ಡಾ. ಸುಬ್ರಹ್ಮಣ್ಯ ಭಟ್ಟ
54	ಪೋಷಣಾ ಆದರ್ಶಪಾತ್ರಾಣಿ ಜೀವನ ಮೌಲ್ಯಾನಿ ಚಿತ್ರಣ	ಶ್ರೀ. ಡಾ. ಎನ್.ಎಸ್. ಸುರೇಶ,
55	ಕವಿಹುಲಗುರು ಕಾಳಿದಾಸನ ಕಾವ್ಯಗಳಲ್ಲಿ ಭಾರತೀಯ ಸಂಸ್ಕೃತಿ	ರಾಮಕುಮಾರ್
56	ಭಾಸ ಕವಿಯ ನಾಟಕಗಳಲ್ಲಿ ಸಂಸ್ಕೃತಿಯ ಪೋಷಣೆ ಮತ್ತು ಜೀವನ ಮೌಲ್ಯಗಳು	ಶ್ರೀಮತಿ. ಸುಷ್ಮಾ ಎಚ್.ಆರ್.
57	ಕಾಳಿದಾಸನ ಕಾವ್ಯಗಳಲ್ಲಿ ಭಾರತೀಯ ಸಂಸ್ಕೃತಿ	ಶ್ರೀ. ಡಾ. ಸೆಲ್ವಪ್ಪ
58	ಮಕ್ಕಳ ಲಾಲನೆ-ಪಾಲನೆ: ಬಾಣಾಕ್ಷನ ದೃಷ್ಟಿ	ಡಾ. ಗಣಪತಿ ಆರ್ ಭಟ್
59	Concept of food culture in ancient era	Smt. Dr. Geeta kumashikar
60	Guru Shishya tradition. A part of ancient culture in Mahabharata perspective	Smt. Dr. Padmaja D.S
61	A conceptual view on Indian culture in Shravya Drushya Kaavyas	

Smt. Roopa vijay

ಸಾಹಿತ್ಯದಲ್ಲಿ

ಎಚ್

ಒಂದು ದೇಶದ ಜನರ ನಡವಳಿಗಳನ್ನು ಸಾಹಿತ್ಯವು ಮೊದಲಿಂದಲೂ ಭಾರತೀಯರು ಅವರ ಸಂಬಂಧ ಹೇಗಿದೆ ದೇವರು ಅ ಮೊದಲಾದ ಸಂಗತಿಗಳನ್ನು ಕುರಿತು ಗಂ ಮಹಾಭಾರತ ಭಾಗವತದಂಥ ಕೃತಿಗಳ ಬಂದಿದ್ದಾರೆ. ಅಕ್ಷರ ಅರಿಯದವರೂ ಭ ನೋಡುಗ ಸಂಸ್ಕೃತಿ ಅದಕ್ಕೆ ಕಾರಣ. ಹ ಸಮುದಾಯದಲ್ಲಿ ಕೇಳಿಸುತ್ತಾ ನೋಡಿ ನಮ್ಮದು. ಗಮಕವಾಚನ ಮಾಡುವವ ಮಾರ್ದೇಶ್ವರ,ಮಂಟೇಸ್ಸಾಮಿ, ಅರ್ಜುನ ಮನೆಯಲ್ಲೋ,ಸಾಮಾನ್ಯರ ಮನೆ ನಡೆಯುತ್ತಿದ್ದ ಬಯಲಾಟ, ಯಕ್ಷಗ ಹಾಡಿನ ರೂಪದ ಕಥೆಗಳನ್ನು ಗಮನಿಸಬೇಕು. ಸಾಹಿತ್ಯ ಎಂಬುದು ಕೃಷ್ಣ, ಹರಿಶ್ಚಂದ್ರ, ನಳ ಮೊದಲಾದ ಸಾಹಿತ್ಯ ಧೀರೋದಾತ್ತವಾಗಿ ಚಿತ್ರ ಮೂಲಗುರಿ ಇದೇ.ರಾಮಾಯಣ ತಮ್ಮ ಬದುಕಿನ ಸಂದರ್ಭದಲ್ಲಿ ಸಂಸ್ಕೃತದಲ್ಲಿ ಹುಟ್ಟಿದ ಮಹಾ ಬಂದಿರುವುದನ್ನು ನಾವು ನೆನೆಯ ಹಳ್ಳಿಹಳ್ಳಿಯಲ್ಲೂ ಬೆಳೆದುಕೊಳ್ಳು ಇಲ್ಲಿ ಸೀತ ಅಡುಗೆ ಮಾಡಿದ್ದಳು

# वेद-पुराण-महाकाव्यादिषु भारतीयसंस्कृतेः चित्रणम्

-डा. तिरुमलः, सहप्राध्यापकः-सुरानामहाविद्यालयः

उत्तरं यत्समुद्रस्य हिमाद्रेश्चैव दक्षिणम् । वर्षं तद्भारतं नाम भारती यत्र सन्ततिः ॥

हिमालयं समारभ्य यावदिन्दुसरोवरम् । तं देवनिर्मितं देशं हिन्दुस्थानं प्रचक्षते ॥(विष्णुपुराणम्)

हिमालयहिन्दुमहासागरयोर्मध्ये विद्यमानायामस्यां पुण्यकर्मभूमौ विराजते आर्षपरम्परान्विता भारतीसन्ततिः । सन्ततिरेषा सम्भाषते संस्कृतादिविविधभाषाः सुखेन जीवति च । सम्पर्कसाधनीभूतभाषासु मुख्या मधुरा दिव्या गीर्वाणभारतीत्यादिनाम्ना प्रसिद्धा प्राचीना च संस्कृतभाषा । अत एव कथ्यते पण्डितैः “ भारतस्य द्वे प्रतिष्ठे संस्कृतं संस्कृतिस्तथा ” इति ।

संक्रियतेऽनयेति व्युत्पत्त्या मानवस्य समाजस्य वान्तरिकविकाससूचकशब्दोऽत्र संस्कृतिः । यथा सभ्यताशब्देन भौतिको विकासः संसूच्यत एवमेव संस्कृतिपदेन पुनराध्यात्मिकानां विचाराणां, धार्मिकानां भावानाम् दार्शनिकस्य ज्ञानस्य, सत्साहित्यस्य, ललितकलानां वैशिष्ट्यस्य, शौचाचाराणाम्, जीवनादर्शनाञ्चोत्कर्षो गृह्यते ।

भारतीया संस्कृतिस्तु विश्वसंस्कृतिषु श्रेष्ठा प्रेष्ठा वदान्या सनातना चिरन्तना च वर्तते । उक्तिस्तु- **भारतस्य द्वे प्रतिष्ठे संस्कृतं संस्कृतिस्तथा** । विश्वस्य सर्वे देशाः यदा अज्ञानान्धकारे निमग्नाः असभ्याः असंस्कृताश्चावर्तन्त, आचारव्यवहाराणां नामापि नाजानन्त, स्वार्थसाधनमेव जीवनलक्ष्यममन्यन्त तदा भारतीयाः **परस्परं भावयन्तः योगक्षेममवाप्स्यथ** । “**सर्वे भवन्तु सुखिनः**” अन्वतिष्ठन् । मनुना एतदर्थमेव साभिमानम् उद्घोषितम्-

**एतद्देशप्रसूतस्य सकाशादग्रजन्मनः । स्वं स्वं चरित्रं शिक्षेर्न् पृथिव्यां सर्वमानवाः ॥**

भारतीया संस्कृतिस्तु देवपरायणा वर्तते । सर्वमेव- “**यत्करोषि यदश्रासि यज्जुहोषि ददासि यत् । यत्तपस्यसि कौन्तेय तत्कुरुष्व मदर्पणम् ॥**” कायजातं देवार्पणभावनया कुर्वन्तो भारतीयाः किमप्यसन्नानुतिष्ठन्ति । आत्मवत्सर्वभूतेषु व्यवहरन्तो भारतीयाः कस्याप्यहितं न कुर्वन्ति । तदुररीकृत्य जोघुष्टं

केनापि सता - अष्टादशपुराणेषु व्यासस्य वचनद्वयम् । परोपकारः पुण्याय पापाय परपीडनम् ॥  
 भारतीया संस्कृतिस्तु धर्ममूला वर्तते । श्रूयते च महानारायणोपनिषदि- **धर्मो विश्वस्य जगतः प्रतिष्ठा, धर्मेण**  
**पापमपनुदति, लोके धर्मिष्ठं प्रजा उपसर्पन्ति ।** भारतीयाः ऐहलौकिकमभ्युदयं पारलौकिकं श्रेयसञ्च  
 समकालमेव गृह्णन्ति । धर्मलक्षणञ्चास्त्येवम्- **यतो अभ्युदयनिःश्रेयसः सिद्धिः स धर्मः ।** धर्ममूलेषु  
 पुरुषार्थचतुष्टयेषु लौकिकोपभोगस्यात्मकल्याणस्य च विलक्षणः समन्वयो विद्यते । आचारं निर्दिशति  
 गीतोक्तिः- **स्वधर्मे निधनं श्रेयः परधर्मो भयावहः ।** भारते तु जीवनस्य प्रथमश्वासतोऽन्तिमश्वासपर्यन्तम्  
 मानव्यवहारो धर्मनियन्त्रितो वर्तते । यतो हि **आचारहीनं न पुनन्ति वेदाः** इत्युदीरितं सद्भिः ।

कर्मायत्तं फलं पुंसां सुखदुःखादिकञ्चेति मन्यतेऽत्र संस्कृत्याम् । तच्च श्रूयते पुराणे-**तत्फलं भुज्यते**  
**चैव भोगभूमिष्वनुक्रमात् । भारते तु कृतं कर्म शुभं वा शुभमेव च ॥** इह जन्मनि जन्मान्तरे स्वर्गे, नरके,  
 भूतले वा नानाविधयोनिषु परिभ्रमणेऽपि कर्माणि न परित्यजन्ति कर्तारम् । विश्वासेनानेन भारतीयसमाजे  
 सदाचारस्य महती प्रतिष्ठा सञ्जातास्ति ।

सहिष्णुता हि सा तपश्चर्यात्मदमनञ्च सन्ति बहवो गुणा स्पृहणीया अस्याः भारतीयाया संस्कृत्याः ।  
 रङ्गनाथशर्मवर्येण एकचक्रम् - नामकरूपके धर्मराजमुखेन स्पष्टीक्रियते यत्- **सत्यं माता पिता ज्ञानं धर्मो**  
**भ्राता दया सखा । शान्तिः पत्नी क्षमा पुत्रः षडेते मम बान्धावाः ॥** अत्र तितिक्षा धर्मावयवभूतास्ति ।  
 भारतीयाः उदात्तवृत्तयः वसुधैव कुटुम्बकमिति भावनया सम्मिलित्वा आनन्देन परस्परं भावयन्ति जीवन्ति च ।  
 उपदेशो हि- **अयं निजः परो वेति गणना लघुचेतसाम् । उदारचरितानान्तु वसुधैव कुटुम्बकम् ।**  
 भूतलप्राणिषु कुटुम्बभावना परमश्लाघ्या विशिष्टता वर्तते । सर्वेषामेव प्राणिनामार्तिनाशनं, स्वार्थान् परित्यज्य  
 परार्थघटनं, स्वार्थो यस्य परार्थ एव सः नृणामग्रणी इति धारणा, **तेन त्यक्तेन भुञ्जीथाः** विश्वासोऽयम् इत्येतानि  
 भारतीयायाः संस्कृत्याः अवयवभूतानि सन्ति ।

भारतीयाः त्यागवृत्त्या आत्मसुखनिरपेक्षतया श्रमप्रवृत्ताः सेवाधर्ममनुतिष्ठन्तोऽद्यापि विश्वं  
 विस्मयविमुग्धमेव कुर्वन्ति । **न कर्मणा न प्रजया धनेन त्यागेनैकेऽमृतत्वमानशुः** इति हि  
 तैत्तिरीयारण्यकोपनिषद्वाक्यम् । **एकं सद्विप्रा बहुधा वदन्ति** इत्युक्तिरिव सर्वे एव स्वाभिमतं पन्थानमनुसर्तुं  
 स्वतन्त्राः यतोऽत्र सम्यग्ज्ञातमस्ति यथा ऋजुकुटिलनानापथजुषां नदीनां गम्यो जलनिधिरस्ति, एवमेव  
 विविधाभिः उपासनापद्धतिभिरेको जगदीश्वर एवाराध्यते । तथा हि वेदमन्त्रः-**विश्वतश्चक्षुरुत विश्वतोमुखो**  
**विश्वतो हस्त उत विश्वतस्पात् । सम्बाहुभ्यां नमति सम्पतत्रैर्द्यावापृथिवी जनयन् देव एकः ॥** एवमपि  
 श्रूयते - **आकाशात्पतितं तोयं यथा गच्छति सागरम् । सर्वदेव नमस्कारः केशवं प्रतिगच्छति ॥** अत्र तु

अश्रीमच्छध्वं भारताः, अमृतं वा आपः, नाप्सु मूत्रपुरीषं कुर्यात् न निष्ठीवेत् न विवसनस्त्रायात्

इन्द्रियनिग्रहः- मम्मटस्य काव्यप्रकाशे- जितेन्द्रियत्वं विनयस्य कारणं गुणप्रकर्षो  
विनयादवाप्यते । गुणाधिके पुंसि जनोऽनुरज्यते जनानुरागप्रभवा हि सम्पदः ॥

सत्यम्- तैत्तिरीयोपनिषदः शिक्षावल्याम्- सत्यं वद धर्मं चर स्वाध्यायान्मा प्रमदः ।

अक्रोधः- गीतायाम्- क्रोधाद्भवति सम्मोहः सम्मोहात्स्मृतिविभ्रमः । स्मृतिभ्रंशात् बुद्धिनाशः  
बुद्धिनाशात् प्रणश्यति ॥

भारतीयसंस्कृतेर्विलक्षणं गुणमस्ति समन्वयभावना, सारग्रहणं वा । ऋग्वेदे- **सद्गच्छध्वं संवदध्वम्**  
**सं वो मनांसि जानताम्** । **“समानेन वो हविषा जुहोमि”** । भारतीयाः हंसवत् सर्वत्रैव सारं गृहीतुमसारं  
त्यक्तुञ्च सर्वदैव सयत्नाः वर्तन्ते । अद्य तु यदस्याः कमनीयमाह्लादकं सजीवञ्च रूपं दृष्टिपथमायाति तच्च  
समन्वयभावितमेव वर्तते ।

भारतीयसंस्कृत्यां कामार्थो समुपेक्षितौ न स्तः । मनुस्मृतौ- **प्रथमे नार्जिता विद्या द्वितीये नार्जितं**  
**धनम् । तृतीये नार्जितो धर्मः चतुर्थे किं करिष्यति** ॥ गृहस्थानामनिवार्यतयोपभोग्यौ एवाख्यातौ वर्तते  
कामार्थो । परमेतौ एवं नियन्त्रितौ यथा तयोरतिधर्ममोक्षवाधिका न भवेत् । एवमेषा भारतीया संस्कृतिः  
सन्तुलितं जीवनमेवोपस्थापयति ।

भारतीया संस्कृतिः स्वोदात्तगुणैर्विश्वजनीना मानवानामभ्युदयनिश्रेयससाधनामूला चास्ति । अद्य तु  
मनोमालिन्यग्रस्ताय विश्वाय संस्कृतिरेषाश्रयणीया वर्तते । अनयैव मनुष्यस्य मनस्तापः नश्यति सन्तोषादयो  
पुनः जीवनं सुखमयञ्च भविष्यति । विश्वकल्याणाय संस्कृतिरेषानुवर्तिता सुखप्रसारिका भविष्यतीति नात्र  
सन्देहः । गीतायाः तृतीयेऽध्याये- **यद्यदाचरति श्रेष्ठः तत्तदेवेतरो जनः । स यत्प्रमाणं कुरुते**  
**लोकस्तदनुवर्तते** । सनातनाध्यात्मप्रधानसंस्कृतेरस्याः अनुसरणेन भारतं विश्वगुरुरेव भूतभविष्यद्वर्तमाने ।

**सर्वे भवन्तु सुखिनः सर्वे सन्तु निरामयाः सर्वे भद्राणि पश्यन्तु मा कश्चिद्दुःखभाग्भवेत् ॥**

Rajajinagar Education Society's



**SRI AUROBINDO COLLEGE**



Affiliated to Bangalore University & NAAC Accredited B+  
#6/c, 5<sup>th</sup> Main, Dr M.C.Modi Road, Mahalakshmi Puram, Bengaluru-56  
www.sriarobindocollege.ac.in Ph: 980-23492449

**A ONE DAY NATIONAL SEMINAR**

on

**"PORTRAYAL OF INDIAN  
CULTURE IN LITERATURE"**

**15 July 2022**

organised by

**Departments of Languages**

in Association with

**Internal Quality Assurance Cell**

**Copy Right - 2022**  
**ISBN No - 978-93-85291-13-5**

**Publishers Address**

**EnkayBooks & Infotech**  
**#209, Harisadan, 20 Ansari Road, New**  
**Delhi - 110002**

- 43 ಗೀತಾರ್ಥ ವಿವರಣೆ ಪ್ರತಿಪಾದಿತ ಜೀವನ ನಿರ್ವಹಣೆ ಸೂತ್ರಾಣಿ  
 44 ವೇದಾಂತೈಃ ಪ್ರಸ್ಥಾನತ್ರಯಭಾಷ್ಯಾಣಿ  
 45 ಭಾರತೀಯ ವೈದ್ಯವಿದ್ಯೆಯಲ್ಲಿ ಆಹಾರ ಸಂಸ್ಕೃತಿ  
 46 ಸಂಸ್ಕೃತ ಗ್ರಂಥಗಳಲ್ಲಿ ಸಂಸ್ಕೃತಿಯ ಅನಾವರಣ  
 47 ಕಾವ್ಯ ಶೋಭೆಯನ್ನು ಹೆಚ್ಚಿಸುವಲ್ಲಿ ಅಲಂಕಾರಗಳು,  
 ಅಲಂಕಾರಶಾಸ್ತ್ರಗ್ರಂಥಗಳ ಕೊಡುಗೆ  
 48 ಅಲಂಕಾರಶಾಸ್ತ್ರಕ್ಕೆ ರುದ್ರಟನ ವಿಶಿಷ್ಟ ಯೋಗದಾನ  
 49 ರಾಮಾಯಣದ ಆದರ್ಶ ಪಾತ್ರಗಳು ತಿಳಿಸುವ ಜೀವನ ಮೌಲ್ಯಗಳು  
 50 ಸಂಸ್ಕೃತ ಸಾಹಿತ್ಯದಲ್ಲಿ ಭಾರತೀಯ ಸಂಸ್ಕೃತಿಯ ಚಿತ್ರಣ  
 51 ವೇದ - ಪುರಾಣ - ಮಹಾಕಾವ್ಯಗಳಲ್ಲಿ ಭಾರತೀಯ  
 ಸಂಸ್ಕೃತಿಯ ಚಿತ್ರಣ  
 52 ವೇದ ಪುರಾಣ ಮಹಾಕಾವ್ಯಾದಿಷು ಭಾರತೀಯ  
 ಸಂಸ್ಕೃತೇಃ ಚಿತ್ರಣಮ್  
 53 ಭಾರತೀಯ ಸಂಸ್ಕೃತಿಯಲ್ಲಿ ಆದರತೆಗಳು  
 54 ಶ್ರೀ ರಾಮಾಯಣ . ಮಹಾಭಾರತ ನಾಟಕಾದೀಷು ಸಂಸ್ಕೃತಿ  
 ಪೋಷಕಾಃ ಆದರ್ಶಪಾತ್ರಾಣಿ ಜೀವನ ಮೌಲ್ಯಾನಿ ಚ  
 55 ಕವಿಕುಲಗುರು ಕಾಳಿದಾಸನ ಕಾವ್ಯಗಳಲ್ಲಿ  
 ಭಾರತೀಯ ಸಂಸ್ಕೃತಿ  
 56 ಭಾಸ ಕವಿಯ ನಾಟಕಗಳಲ್ಲಿ ಸಂಸ್ಕೃತಿಯ ಪೋಷಣೆ ಮತ್ತು  
 ಜೀವನ ಮೌಲ್ಯಗಳು  
 57 ಕಾಳಿದಾಸನ ಕಾವ್ಯಗಳಲ್ಲಿ ಭಾರತೀಯ ಸಂಸ್ಕೃತಿ  
 58 ಮಕ್ಕಳ ಲಾಲನೆ-ಪಾಲನೆ: ಚಾಣಾಕ್ಯನ ದೃಷ್ಟಿ  
 59 **Concept of food culture in ancient era**  
 60 **Guru Shishya tradition. A part of ancient**  
**culture in Mahabharata perspective**  
 61 **A conceptual view on Indian culture in**  
**Shravya Drushya Kaavyas**

ಶ್ರೀ. ವಿನಯ ಕುಮಾರ್:  
 ಶ್ರೀ. ರಾಮಚಂದ್ರ ಎನ್ ಯು  
 ಶ್ರೀಮತಿ. ಡಾ. ಅಂಜನಾ ಮಠದ  
 ಶ್ರೀಮತಿ. ಡಾ.ದೀಪಶ್ರೀ ಎಸ್.  
 ಶ್ರೀ. ದ್ವಾರಕೀಶ ಎಂ

ಶ್ರೀ ಕೆ.ಕೃಷ್ಣಮೂರ್ತಿ ಮಯ್ಯ  
 ಶ್ರೀಮತಿ. ಡಾ.ಮೈತ್ರೇಯಿ ಎಚ್. ಎಲ್  
 ಶ್ರೀ. ನಾಗೇಶ ಎಸ್ ಡೊಂಗಾರ  
 ಶ್ರೀ. ಪೂರ್ಣಪ್ರಜ್ಞಾಚಾರ್ಯ ಜಿ ಮಲ್ಲಿ

ಶ್ರೀ. ಶಿವಾನಂದ ಎಲ್ ಬಿ  
 ಶ್ರೀ. ಶ್ರೀಶ ಪಾವಂಜಿ

ಶ್ರೀ. ಡಾ. ಸುಬ್ರಮಣ್ಯ ಭಟ್ಟ  
 ಶ್ರೀ. ಡಾ. ಎನ್.ಎಸ್. ಸುರೇಶ,  
 ರಾಮಕುಮಾರ್

ಶ್ರೀಮತಿ. ಸುಷ್ಮಾ ಎಚ್.ಆರ್.  
 ಶ್ರೀ. ಡಾ. ಸೆಲ್ವಪ್ಪ  
 ಡಾ. ಗಣಪತಿ ಆರ್ ಭಟ್

**Smt.Dr. Geeta kumashikar**  
**Smt. Dr. Padmaja D.S**

Smt. Roopa vijay

**Abstract:** Indian Culture is very rich with its aesthetics and through that it plans to spread the uniqueness to the entire universe. When it comes to Samskrita Literature most of the poets, dramatists and authors have inculcated the culture in their Kavyas thereby spreading the message far and wide through the readers who have appreciated its beauty. Vedas, Puranas, Ramayana, Mahabharata and other Kavyas have equally contributed to enrich our Culture. Guru Shishya Parampara is a part of this rich Indian heritage. This paper highlights the same in Mahabharata's Perspective.

**Key Words:** Indian Culture, Uniqueness, Samskrita Literature, Guru-Shishya Parampara, Mahabharata.

The **guru-shishya tradition**, or **Parampara** ("lineage"), denotes a succession of teachers and disciples in traditional Indian culture. A formal recognition of this relationship, generally in a structured initiation ceremony where the guru accepts the initiate as a shishya and also accepts responsibility for the spiritual well-being and progress of the new shishya. Sometimes this initiation process will include the conveying of specific esoteric wisdom and meditation techniques. The brightest aspect of Indian culture is its tradition of sacred and ever deepening bond of soul kinship between Guru and Shishya. It is through this spiritual medium of teacher-disciple relationship between Guru and Shishya that India once rose to the position of Jagadguru.

India is the home of guru-shishya tradition. The teacher is supposed to treat his students as his own sons. This tradition is prevalent even today especially in the fields of music and dance. The concept of Guru-Shishya Parampara in Indian culture has always been an important aspect of the education. He moved into the guru's ashram and stayed with him for the next few years acquiring in-depth knowledge. The Guru's duty was not only to teach the student a specific subject, but also to develop the overall personality of the student. The Guru tried to mould the student's character, versatility, confidence, strength and overall vision of life.



The Ideal Guru was the best friend, philosopher and guide to the student. Ideally in the Guru-Shishya Parampara, the relationship was unconditional. Acquisition of knowledge was helped in a value rich environment with focus on the holistic development of the self. Learning as understood from the Vedas is a journey in which the teacher took the disciple from the familiar to the unfamiliar, from the concrete to the abstract. The Guru made him struggle through a process of questioning and reasoning to arrive at theories that were validated, corroborated and then encouraged the students to search for answers by steering him in the right direction. All learners, irrespective of their background, were equal under the constant supervision and tutelage of Guru.

This can be understood from the examples of Mahabharata. Vyasa perhaps experiences this. Vyasa is a central and revered figure in Hindu tradition. He got the name Veda Vyasa because of being the one who classified the Vedas into four parts. Vyasa is also the author of the Mahabharata, as well as a character in it. In fact, he is considered such a renowned guru that the festival of Guru Purnima is dedicated to him. The contrast in the learning process through which Ekalavya, Arjuna and Abhimanyu acquired their knowledge brings out the essence of the relationship. Ekalavya acquired his knowledge through an impersonal Guru. The story of Ekalavya, in Mahabharata, is a unique example of a student who had truly and devotionally accepted Dronacharya as his Master. Abhimanyu learnt the tricks of warfare, through a medium – his mother that too in the womb itself.

The epic talks of four stages of person's life –Brahmacharin, Grihastha, Vanaprastha and Bhikshu. Brahmacharin is the stage where one should devote the first quarter of one's life to study and character building in the house of preceptor. In the ancient times the bondage of Student and teacher was extra ordinary. In Adiparva we have four stories which can be substantiate this statement – Aaruni, Upamanyu, Veda and Uttanka. Aaruni ordered by his preceptor enters the breach in order to prevent the water from running out. Uttanka after finishing his studies risks his own life in order to give Guru Dhakshina to his preceptor's wife.

In the epic fable, the Mahabharata, Dronacharya and Arjuna shared a special bond as teacher and pupil. Serving as a teacher for the royal princes, Dronacharya found that Arjun was an exceptional student and stood out from the rest of the princes. From the very first test, Dronacharya saw immense determination and focus in Arjuna and predicted that the prince would, one day, become a great warrior. Arjuna, in turn, was greatly inspired by the number

challenges that Dronacharya put them through during the training. He outshined everybody in all the tests and built immense focus and concentration. Seeing such immense talent in Krishna, Guru Dronacharya bestowed him with special wisdom of the Devastras and the ceremonial bow of Brahma. With his enormous drive and dedication towards learning, Arjun held a special place in the heart of his guru. It is even said that Dronacharya loved Arjun like his own child. Were it not for Arjuna's dogged determination and sheer talent, Drona would have kept reserved his best secrets for his dear son, Ashwattama. Dronacharya's legend as a great teacher and warrior is marred by his strong moral and social views, which have inspired debates about morality and dharma in the Mahabharata epic. Arjuna became proficient under the loving care and affection of his guru, Dronacharya. In an act of reverence, Arjuna shoots arrows as homage at the feet of Dronacharya and Bhishma. He seeks their permission and blessings to start the war. This demonstrates the exalted position of the Guru, and the discipline of the disciple.

The three concepts of the relationship are identified in the Gita as correctiveness, knowing the mind of the Shishya and the teacher's readiness to alter instructions in case repetition is inadequate. In chapter II when Arjuna is in a dilemma and highly emotional, Krishna the Jagad Guru condemns his behaviour and this does not befit a person like him. Here the teacher increases the receptivity of the disciple's mind through the corrective process. Lord Krishna brings out the Guru's understanding of the Shishya's mind in the sixth chapter. He advises Arjuna to control his restlessness and turbulent mind through yoga and be ready for the next action. Krishna then asks Arjuna if his ignorant mind is ready to learn. Arjuna replies by the grace of his acharya he is free of doubt and is ready. This reference shows the willingness of the guru to change as per the needs of his pupil. Even modern management Guru's talk of bringing about change in oneself rather than changing things, including the people around you.

Conclusion - It is imperative for India's pallid, non-inspiring educational institutions to start foreseeing a future which talent imprisoned in the educational institutions breaks forth to enjoy the world beyond the class rooms, under the able guidance of the teacher who can be more of a mentor. This going back, as it were to the Guru-Shishya Parampara, will empower the individual to develop and perfect special skills.

**References:**

1. IOWA Journal of Cultural Studies. USA, 2002
2. Harshananda Swami: A concise Encyclopaedia of Hinduism – volume 1, Ramakrishna Mutt, Bangalore, 2008
3. Various authors: Cultural Heritage of India –Book II, Ramakrishna Institute of Culture, Calcutta, 2001
4. Suri Laxman: Bharatha Sangraha, Bangalore University press, Bangalore, 1997
5. Pusalkar. A.D: Studies in epics and puranas, Bharatiya Vidya Bhavan, Mumbai, 1961.
6. Jairam Rajini: Mahabharata- A Transcultural Study, Unpublished Ph.D Thesis, Bangalore University, Bangalore, 2009
7. Simha. S.L.N: The Mahabharatha – The story and its significance – Birla academy of art and culture publications, Calcutta, 1983

Culture can be defined as the way of life of a people, including their beliefs, customs, arts, and other aspects that distinguish them from other groups. Society is a group of people who interact with each other and share a common culture. The interaction between culture and society is a complex one, and it can be at local, national, or international levels.

Considering these, we can see that other influences

Literary

Kavehe

Lokotta

the skill

words (

Accord

means

Kaavya

Apaar

Gener

contro

Broad

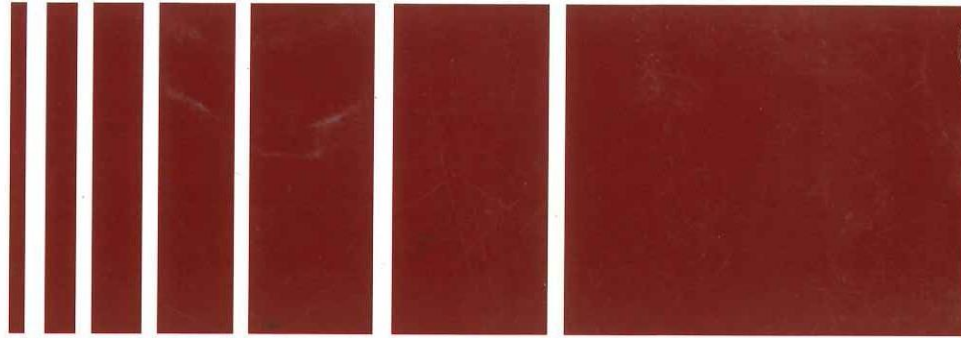
•

e.g.

In r



Bangalore University w.e.f. 2019-20



# ADVANCED CORPORATE ACCOUNTING

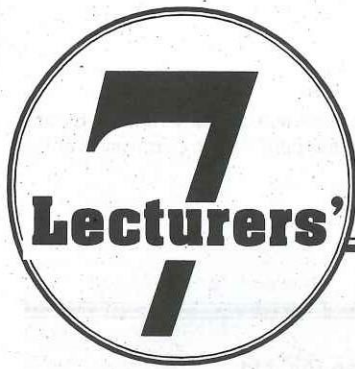
## INCLUDES

- Problems highlighted with year identification
- Selected questions with answers
- Comprehensive for student learning
- A lecturer-friendly presentation

R. G. Saha  
Geetha P.  
Manjunath D. R.  
Raghavendra K.  
Anitha A.  
Maya Joe C.  
Aparna Mathapathi

*Vision book house*

ISO 9001:2015 CERTIFIED



L. G. WAN SINGH  
Mobile: 9379847008  
E-mail: hphblr@hotmail

## ADVANCED CORPORATE ACCOUNTING

[As per New CBCS Syllabus for 4<sup>th</sup> Semester BBA,  
Bangalore University w.e.f 2019-20]

**Dr. R. G. Saha** MBA, M.Com, M.Sc(IT), M.Phil, Ph.D(fin.), Ph.D(mkt.),  
Former Associate Prof. & HOD, KKECS Institute of Management,  
Visiting Professor to various B-Schools,  
Founder, Vision Book House, Proprietor, Archita Education, Bengaluru.

**Geetha P.** M.Com.,  
Asst. Professor, Department of Commerce,  
NMKRV College for Women, Bengaluru.

**Manjunath D. R.** M.Com., PGDFM  
Asst. Professor, Department of Commerce & Management,  
Global Institute of Management Science, Bengaluru.

**Raghavendra K.** M.Com, MBA, PGDMM, (PhD)  
Asst. Professor & Head, Department of BBA  
Acharya Bangalore B-School, Bengaluru.

**Anitha A.** M.Com., KSET, NET  
Asst. Professor, Department of Commerce & Management,  
Dayananda Sagar College of Arts, Science and Commerce, Bengaluru.

**Maya Joe C.** MBA, PGDCA, (Ph.D)  
Adjunct Faculty,  
Christ Academy Institute for Advanced Studies, Bengaluru.

**Aparna Mathapathi** M.Com., (Gold Medalist)  
Asst. Professor, Department of Commerce & Management,  
Surana College, South End, Bengaluru.



*Vision book house* \*\*

NEW DELHI • BANGALORE

(\*\* An Imprint of Himalaya Publishing House Pvt. Ltd.)

© AUTHORS

No part of this publication may be reproduced, stored in a retrieval system, or transmitted in any form or by any means, electronic, mechanical, photocopying, recording and/or otherwise without the prior written permission of the publishers.

First Edition: 2022

---

---

Published by : Mrs. Meena Pandey for Himalaya Publishing House Pvt. Ltd.,  
"Ramdoot", Dr. Bhalerao Marg, Girgaon, Mumbai - 400 004.  
Phone: 022-23860170, 23863863; Fax: 022-23877178  
E-mail: himpub@bharatmail.co.in; Website: www.himpub.com

*(Vision Book House, an Imprint of Himalaya Publishing House Pvt. Ltd.)*

**Branch Offices :**

- New Delhi** : "Pooja Apartments", 4-B, Murari Lal Street, Ansari Road, Darya Ganj,  
New Delhi - 110 002. Phone: 011-23270392, 23278631; Fax: 011-23256286
- Nagpur** : Kundanlal Chandak Industrial Estate, Ghat Road, Nagpur - 440 018.  
Phone: 0712-2721215, 2721216
- Bengaluru** : Plot No. 91-33, 2nd Main Road, Seshadripuram, Behind Nataraja Theatre,  
Bengaluru - 560 020. Phone: 080-41138821; Mobile: 09379847017,  
09379847005
- Hyderabad** : No. 3-4-184, Lingampally, Besides Raghavendra Swamy Matham, Kachiguda,  
Hyderabad - 500 027. Phone: 040-27560041, 27550139
- Chennai** : New No. 48/2, Old No. 28/2, Ground Floor, Sarangapani Street, T. Nagar,  
Chennai - 600 017. Mobile: 09380460419
- Pune** : "Laksha" Apartment, First Floor, No. 527, Mehunpura,  
Shaniwarpeth (Near Prabhat Theatre), Pune - 411 030.  
Phone: 020-24496323, 24496333; Mobile: 09370579333
- Lucknow** : House No. 731, Shekhupura Colony, Near B.D. Convent School, Aliganj,  
Lucknow - 226 022. Phone: 0522-4012353; Mobile: 09307501549
- Ahmedabad** : 114, "SHAIL", 1st Floor, Opp. Madhu Sudan House, C.G. Road, Navrang Pura,  
Ahmedabad - 380 009. Phone: 079-26560126; Mobile: 09377088847
- Cuttack** : Plot No 5F-755/4, Sector-9, CDA Market Nagar, Cuttack - 753 014,  
Odisha. Mobile: 09338746007
- Kolkata** : 108/4, Beliaghata Main Road, Near ID Hospital, Opp. SBI Bank,  
Kolkata - 700 010. Phone: 033-32449649; Mobile: 07439040301
- DTP by** : *SPS, Bengaluru.*
- Printed at** : M/s. Giriraj Printers, Hyderabad. On behalf of HPH.

# Preface

We have great pleasure in presenting First edition "*Advanced Corporate Accounting*" written for students of UG courses. The related matters are written in a simple and easily understandable.

This volume is an attempt to provide the students with thorough understanding of Advanced Corporate Accounting. We have presented the subject matter in a systematic manner with liberal use of charts and diagrams where ever necessary so as to make it interesting and sustain students' interest. We thank almighty for showering his substantial blessings and giving us the determination in preparing this book.

In writing this book we have benefited immensely from the studies of a number of books and the articles written by scholars spread over various books, journals and magazine. We are grateful to them.

We are sure this book will prove extremely useful to students and teachers alike. This book would not have seen the light, but for the grace of God and the blessings and support of our family members and friends.

We are quite confident, though, that the book can also be adopted and used successfully. We believe that the book is even suited for self-study. This book will provide an up-to-date first foundation for informed discussion of today's national and global issues.

We offer our gratitude to Himalaya Publishing House Pvt. Ltd., who is leader in Commerce and Management publications. Our sincere regards to Mr. Vijay Pandey, Mr. Inyath Ulla Khan and Mr. Sabeer Pasha for interest shown and for the best effort put forth by the matter of publication of this book.

Finally, we express our sincere thank to SPS, Bengaluru for their excellent computer typesetting work and the printing.

We respectfully acknowledge that the critical comments and constructive suggestions for the improvement of this book are most welcome and will be greatly appreciated.

**Bengaluru**

**May, 2022**

**Authors**

## *Syllabus*

### **Unit 1: Underwriting of Shares**

Meaning, Underwriting Agreements, Underwriting Commission, Underwriter, Functions, Advantages. Types of Underwriting, Marked and Unmarked Applications. Problems (Excluding Journal entries).

### **Unit 2: Mergers and Acquisitions of Companies**

Meaning of Amalgamation and Acquisition, Types of Amalgamation, Amalgamation in the Nature of Merger, Amalgamation in the Nature of Purchase. Methods of purchase consideration. Calculation of Purchase Consideration (Ind AS 103) (Old AS 14). Net Asset Method, Net Payment Method. Accounting for Amalgamation. Ledger Accounts in the Books of Transferor Company and Journal Entries in the Books of Transferee Company, Preparation of New Balance Sheet (Vertical Format) (Excluding External Reconstruction).

### **Unit 3: Internal Reconstruction**

Meaning, Objective, Procedure, Forms of Reduction, Passing of Journal Entries, Preparation of Reconstruction Account. Preparation of Reconstructed Balance Sheet (Vertical Format) Problems.

### **Unit 4: Liquidation of Companies**

Meaning of Liquidation. Types of Liquidation. Order of Payment, Liquidator, Calculation of Liquidators Remuneration, Preparation of Liquidators Final Statement of Account.

### **Unit 5: Recent Developments in Accounting and Accounting Standards (Theory Only)**

Meaning of Recent Development. Human Resource Accounting, Environmental Accounting and Social Responsibility Accounting. Forensic Accounting



# Contents

<i>Sl. No.</i>	<i>Unit Name</i>	<i>Page No.</i>
<b>Unit - 1</b>	<b>Underwriting of Shares</b>	<b>1 - 48</b>
	Introduction Meaning of Underwriting Underwriting Agreements Underwriting Commission Underwriter Functions of Underwriting Advantages of Underwriting Types of Underwriting Marked and Unmarked Applications Problems on Underwriting Share Review Questions Practical Problems <i>with Answer</i>	
<b>Unit - 2</b>	<b>Mergers and Acquisition of Companies</b>	<b>49 - 132</b>
	Introduction Meaning of Amalgamation and Acquisition Types of Amalgamation Amalgamation in the Nature of Merger Amalgamation in the Nature of Purchase Methods of Purchase Consideration Calculation of Purchase Consideration (Ind AS 103) Net Asset Method Net Payment Method Accounting for Amalgamation (Problems on both the methods) Entries and Ledger Accounts in the Books of Transferor Company and Transferee Company Preparation of New Balance Sheet Review Questions Practical Problems <i>with Answer</i>	

<b>Unit - 3</b>	<b>Internal Reconstruction</b>	<b>133 - 190</b>
	Introduction Meaning of Internal Reconstruction Objective of Internal Reconstruction Procedure of Internal Reconstruction Form of Reduction Passing of Journal Entries Preparation of Reconstruction Accounts Preparation of Balance Sheet after Reconstruction Review Questions Practical Problems <i>with Answer</i>	
<b>Unit - 4</b>	<b>Liquidation of Companies</b>	<b>191 - 226</b>
	Introduction Meaning of Liquidation Types of Liquidation Order of Payment Calculation of Liquidator's Remuneration Preparation of Liquidators Final Statement of Account Review Questions Practical Problems <i>with Answer</i>	
<b>Unit - 5</b>	<b>Recent Developments in Accounting and Accounting Standards</b>	<b>227 - 244</b>
	Introduction Meaning of Recent Development Human Resource Accounting Environmental Accounting Social Responsibility Accounting Forensic Accounting Review Questions	

# UNIT - 1

## Underwriting of Shares

---

---

### Overview

- Introduction
- Meaning of Underwriting
- Underwriting Agreements
- Underwriting Commission
- Underwriter
- Functions of Underwriting
- Advantages of Underwriting
- Types of Underwriting
- Marked and Unmarked Applications
- Problems on Underwriting Share

# UNDERWRITING OF SHARES

## INTRODUCTION

A newly formed company enters into an agreement with an under-writer to the effect that he will take up shares or debentures offered by it to the public but not subscribed for in fully by the public. An agreement may become necessary when a company issues shares or debentures for the first time to the public or subsequently when it is in need of working capital.

When the company does not receive 90 per cent of issued amount from public subscription, within 120 days from the date of opening the issue, the company cannot proceed with allotment. In such a case, the company must refund the amount of subscription. In the case of a new company, it cannot obtain a certificate to commence function.

A company is not sure whether the shares or debentures offered for subscription may be taken up by the public. There arises a risk to ensure the success of issue. Therefore, companies resort to underwriting in order to ensure that sufficient number of shares or debentures would subscribed. Thus, risk-bearing or uncertainty bearing is an important function of an underwriter

An under-writer may be an individual, firm or a joint stock company, performing the under-writing function. Under-writing may be defined as a contract entered into by the company with persons or institutions, called under-writers, who undertake to take up the whole or a portion of such of the offered shares or debentures as may not be subscribed for by the public. Such agreements are called 'Under-writing agreement'.

## UNDERWRITING

Underwriting means an agreement with or without conditions to subscribe to the securities of a body corporate when the existing shareholders of such body corporate or the public do not subscribe to the securities offered to them.

The SEBI has defined the Underwriting as "an agreement with or without conditions to subscribe to the securities of a body corporate where the existing shareholders of such body corporate or the public do not subscribe to securities offered to them".

## UNDERWRITING OF SHARES

Underwriting of Shares means the contract in which underwriter agrees to take shares which will not be subscribed by public. For getting fast minimum subscription from public of his issued shares, company has to do this type of contract.

## SUB-UNDERWRITING

An underwriter may himself enter into a sub-agreement with other persons, called sub-underwriters, whereby he transfers a part of his underwriting risk. Just like re-insurance, sub-underwriting helps in spreading the risk. An underwriter may appoint several underwriters to work under him. However, the sub-underwriters have no privacy of contract with the company. They get their commission from the underwriter and are also responsible to him.

## UNDERWRITERS

Underwriters are the person or institution underwriting the public issue of share. They ensure the company that in case the shares that are offered to the public are not subscribed by the public to the extent, the balance of shares will be taken up by them.

## SCOPE OF UNDERWRITING

1. Underwriting acts as a sort of insurance or guarantee against the danger of not receiving minimum subscription, in the absence of underwriting agreement, there is always uncertainty regarding subscription of shares of debentures by the public. The guarantee of the underwriters removes the uncertainty.
2. When shares or debentures are sold through underwriters, there arise more confidence amongst the public. This is because underwriters undertake shares or debentures of only those companies which are sound concerns and whose future is bright.
3. Underwriting creates an impression regarding sound status of a company. It increases the goodwill of the company.

## ADVANTAGES OF UNDERWRITING

1. Underwriting undertake to guarantee the whole or part of the issued shares as they would not be taken up by the public. Therefore the companies issuing securities are relieved from the tension of marketing of securities and of uncertainties in the market.
2. Its help the companies in fulfilling the statutory regulation of minimum subscription.
3. It gives guarantee to adequacy of capital and help companies in raising capital.
4. Investors believe in the issue of securities, if it is guaranteed by reputed underwriters.
5. Its assure a quick sale of securities in the market.
6. An underwriter stimulates industrial development and creates more employment opportunities in the country.

## DISADVANTAGES OF UNDERWRITING

1. Underwriting is very costly method of marketing of securities.
2. Issuing company has to provide secret information about its affairs to the underwriters and misuse of such information is possible.
3. It may secure control on the company by virtue of purchasing large number of shares not purchased by the investing class.

## UNDERWRITING COMMISSION

It is the consideration which is payable to the underwriters for underwriting the shares of the company. This commission is paid at a specified rate on the issue price of the shares underwritten.

Rate of underwriting commission: For the service rendered by the underwriters, they are entitled to a maximum commission of 5% of the issue price of the shares and 2.5% of the issue price of the debentures as per Companies Act. However, the maximum commission payable to underwriters for underwriting shares and debentures as per SEBI guidelines is only 2.5% of the issue price of shares and debentures.

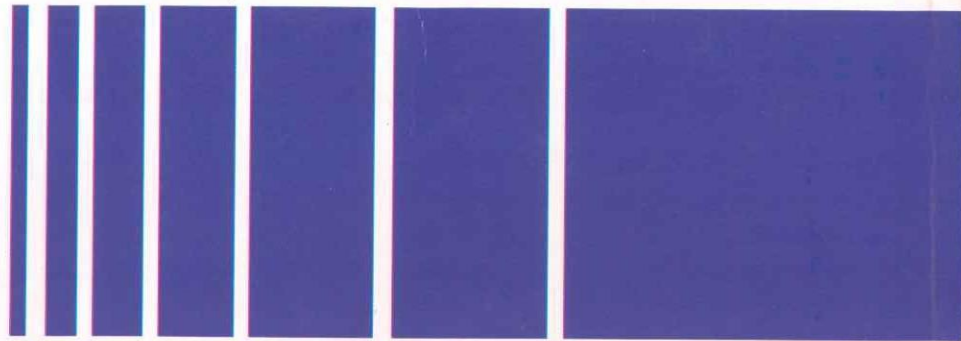
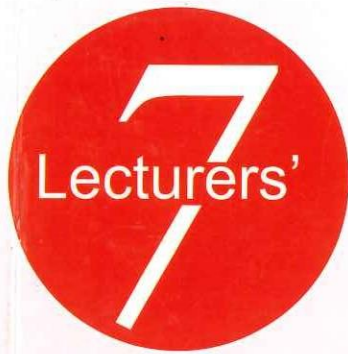
No underwriting commission is payable to any one on shares and debentures not offered to the public.



**SURANA COLLEGE**  
(Autonomous)

ISO Certified | NAAC A+ Grade  
16, South End Road, Bangalore 560004  
Tel: 080-26642292 | 080-22446141  
www.suranacollege.edu.in

Bangalore University w.e.f 2020-21



# FINANCIAL ACCOUNTING

## INCLUDES

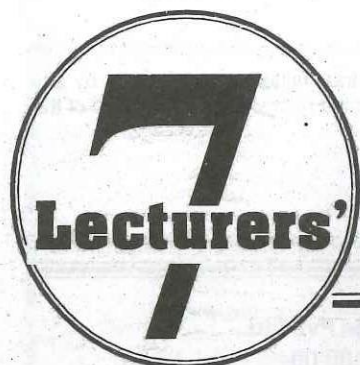
- ➔ Business Lab Activities
- ➔ Practical Problems highlighted with the concept
- ➔ Previous Years Questions Identification
- ➔ Free Solution Book in e-Format
- ➔ Comprehensive for student learning
- ➔ A lecturer friendly presentation

R. G. Saha  
Raghavendra B. N.  
B. G. Lakshmi  
Zameer Pasha  
Geetha P.  
Swathi S.  
Chaithra N.

*Vision book house*

ISO 9001:2015 CERTIFIED

**BHAGWAN SINGH**  
Sr. Sales Executive  
Mobile: 9379847008  
E-mail: hphbr@hotmail.com



# FINANCIAL ACCOUNTING

[As per New CBCS Syllabus for 2<sup>nd</sup> Semester BBA,  
Bangalore University w.e.f 2020-21]

**Dr. R. G. Saha** MBA, M.Com, M.Sc(IT), M.Phil, Ph.D(fin.), Ph.D(mkt.),  
Former Associate Prof. & HOD, KKECS Institute of Management,  
Visiting Professor to various B-Schools  
Founder, Vision Book House, Proprietor, Archita Education, Bengaluru.

**Dr. Raghavendra B. N.**  
MA(Eco.), MBA(Bak. & Fin.), MBA(HR & Mkt.), M.Com., PGDFM, B.Ed., M.Phil., Ph.D,  
Director/Principal, SVR College of Commerce and Management Studies,  
Bengaluru.

**Dr. B. G. Lakshmi** M.Com, MBA, Ph.D  
Asst. Professor, Department of Commerce and Management,  
Surana College, Bengaluru.

**Dr. Zameer Pasha** MBA, M.Phil, SAP FI/CO, Ph.D,  
Asst. Prof., Department of Administration,  
St. Claret College, Bengaluru.

**Geetha P.** M.Com,  
Asst. Prof., Department of Computer & Management,  
NMKRV College for Women, Bengaluru.

**Swathi S.** M.Com, KSET  
Asst. Prof., Department of Commerce and Management,  
Dayananda Sagar Institution, Bengaluru.

**Chaitra N.** M.Com, MBA, (Ph.D),  
Asst. Prof., Department of Commerce and Management,  
East West College of Management, Bengaluru.



*Vision book house* \*\*

NEW DELHI • BANGALORE

(\*\* A Brand of Himalaya Publishing House Pvt. Ltd.)

© **AUTHORS**

No part of this publication may be reproduced, stored in a retrieval system, or transmitted in any form or by any means, electronic, mechanical, photocopying, recording and/or otherwise without the prior written permission of the publishers.

**First Edition: 2021**

---

---

**Published by** : Mrs. Meena Pandey for **Himalaya Publishing House Pvt. Ltd.**,  
Ramdoot, Dr. Bhalerao Marg, Girgaon, Mumbai - 400 004  
**Phone:** 022-23860170/23863863; **Fax:** 022-23877178  
**E-mail:** himpub@bharatmail.co.in; **Website:** www.himpub.com

*(Vision Book House, a brand of Himalaya Publishing House Pvt. Ltd.)*

**Branch Offices** :

- New Delhi** : Pooja Apartments, 4-B, Murari Lal Street, Ansari Road, Darya Ganj,  
New Delhi - 110 002. Phone: 011-23270392, 23278631; Fax: 011-23256286
- Nagpur** : Kundanlal Chandak Industrial Estate, Ghat Road, Nagpur - 440 018.  
Phone: 0712-2721215, 2721216
- Bengaluru** : Plot No. 91-33, 2nd Main Road, Seshadripuram, Behind Nataraja Theatre,  
Bengaluru - 560 020. Phone: 080-41138821;  
Mobile: 9342824929, 09379847017, 09379847005
- Hyderabad** : No. 3-4-184, Lingampally, Besides Raghavendra Swamy Matham, Kachiguda,  
Hyderabad - 500 027. Phone: 040-27560041, 27550139
- Chennai** : New No. 48/2, Old No. 28/2, Ground Floor, Sarangapani Street, T. Nagar,  
Chennai-600 017. Mobile: 09380460419
- Pune** : First Floor, Laksha Apartment, No. 527, Mehunpura, Shaniwarpeth  
(Near Prabhat Theatre), Pune - 411 030. Phone: 020-24496323, 24496333;  
Mobile: 09370579333
- Lucknow** : House No. 731, Shekhupura Colony, Near B.D. Convent School, Aliganj,  
Lucknow - 226 022. Phone: 0522-4012353; Mobile: 09307501549
- Ahmedabad** : 114, SHAIL, 1st Floor, Opp. Madhu Sudan House, C.G. Road, Navrang Pura,  
Ahmedabad - 380 009. Phone: 079-26560126; Mobile: 09377088847
- Ernakulam** : 39/176 (New No. 60/251), 1st Floor, Karikkamuri Road, Ernakulam,  
Kochi - 682011. Phone: 0484-2378012, 2378016; Mobile: 09387122121
- Cuttack** : Plot No. 5F-755/4, Sector-9, CDA Market Nagar, Cuttack - 753 014,  
Odisha. Mobile: 09338746007
- Kolkata** : 9/6, Dharmatala Road, Belurmath, Howrah-711 202, WB.  
Phone: 7226054688; Mobile: 07439040301

**DTP by** : **SPS, Bengaluru.**

**Printed at** : **M/s. Aditya Offset Process (I) Pvt. Ltd., Hyderabad.**



## Preface

We have great pleasure in presenting First edition "*Financial Accounting*" written for students of UG courses. The related matters are written in a simple and easily understandable.

This volume is an attempt to provide the students with thorough understanding of Financial Accounting, methods and techniques. We have presented the subject matter in a systematic manner with liberal use of charts and diagrams where ever necessary so as to make it interesting and sustain students' interest. We thank almighty for showering his substantial blessings and giving us the determination in preparing this book.

In writing this book we have benefited immensely from the studies of a number of books and the articles written by scholars spread over various books, journals and magazine. We are grateful to them.

We are sure this book will prove extremely useful to students and teachers alike. This book would not have seen the light, but for the grace of God and the blessings and support of our family members and friends.

We are quite confident, though, that the book can also be adopted and used successfully. We believe that the book is even suited for self-study. This book will provide an up-to-date first foundation for informed discussion of today's national and global issues.

We offer our gratitude to Himalaya Publishing House Pvt. Ltd., who is leader in Commerce and Management publications. Our sincere regards to Mr. Niraj Pandey and Mr. Vijay Pandey for interest shown and for the best effort put forth by the matter of publication of this book.

Finally, we express our sincere thank to SPS, Bengaluru for their excellent computer typesetting work and the printing.

We respectfully acknowledge that the critical comments and constructive suggestions for the improvement of this book are most welcome and will be greatly appreciated.

**Bengaluru**

**June, 2021**

**Authors**

## *Syllabus*

- Unit 1: Introduction to IFRS:** Need for IFRS, Features of IFRS, Applicability of IFRS, Beneficiaries of Convergence with IFRS (theory only).
- Unit 2: Accounting for Hire-Purchase:** Meaning of Hire Purchase and Installment Purchase System, Legal Provisions, Calculation of Interest, when Rate of Interest and Cash Price is given, when Cash Price and Total Amount Payable is Given, when Rate of Interest and Installments Amount are given but Cash Price is not given, Calculation of Cash Price under Annuity Method, Journal Entries and Ledger Accounts in the Books of Hire Purchaser and Hire Vendor (Asset Accrual Method only).
- Unit 3: Royalty Accounts:** Introduction, Meaning, Technical Terms, Royalty, landlord, Tenant, Minimum Rent, Short Workings, Recoupment of Short Working under, Fixed Period, Floating Period, Recoupment within the Life of a Lease, Treatment of Strike, Stoppage of Work and Sub-lease, Accounting Treatment in the Books of Lessee(tenant), when Royalty is Less than Minimum Rent, when Royalty is Equal to Minimum Rent, when the Right of Recoupment is Lost, when Minimum Rent Account Method is Followed, Passing Journal Entries and Preparation of Ledger Accounts, Royalty Account, Landlord Account, Short workings Account, Minimum Rent when Minimum Rent Account is followed in the Books of Lessee Only.
- Unit 4: Sale of the Partnership Firm:** Introduction, Need for Conversion, Meaning of Purchase Consideration, Methods of Calculating Purchase Consideration, Net Payment Method, Net Asset Method, Passing of Journal Entries and Preparation of Ledger Accounts in the Books of Vendor, Treatment of Certain Items, Dissolution Expenses, Unrecorded Assets and Liabilities, Assets and Liabilities not Taken Over by the Purchasing Company, Contingent Liabilities, Non-assumption of Trade Liabilities, in the Books of Purchasing Company, Passing of Incorporation Entries, Treatment of Security Premium, Fresh Issue of Shares and Debentures to Meet Working Capital, Preparation of Balance Sheet as per 'Companies Act' 2013, under Vertical Format.
- Unit 5: Accounting for Joint Ventures:** Introduction, Meaning, Objectives, Distinction between Joint Venture and Consignment, Distinction between Joint Venture and Partnership, Maintenance of Accounts in the Books of Coverturers, Maintaining Separate Books for Joint Venture, Problems.

### **Business Lab Activities:**

(Skill development business lab activities to be executed through accounting packages)

1. List out the different areas of applications of IFRS in India
2. Develop EMI calculation mechanism in an auto retailers-Two wheelers and Cars
3. Develop E-content for Royalty Agreement
4. Collect the information on 5 recently converted a firm in to joint stock company business organizations
5. Develop E-content for a Joint Venture Agreement

# Contents

SL. NO.	UNIT NAME	PAGE NO.
UNIT - 1	<b>INTRODUCTION TO IFRS</b>	1 - 24
	Introduction to IFRS Meaning of IFRS Need for IFRS Features of IFRS Applicability of IFRS Beneficiaries of Convergence with IFRS Review Questions	
UNIT - 2	<b>ACCOUNTING FOR HIRE-PURCHASE</b>	25 - 84
	Introduction Meaning of Hire Purchase Installment Purchase System Legal Provisions Calculation of Interest When Rate of Interest and Cash Price is given When Cash Price and Total Amount Payable is Given When Rate of Interest Installments Amount are given but Cash Price is not given Calculation of Cash Price under Annuity Method Journal Entries and Ledger Accounts in the Books of Hire Purchaser Journal Entries and Ledger Accounts in the Books of Hire Vendor Review Questions Practical Problems with Answer	
UNIT - 3	<b>ROYALTY ACCOUNTS</b>	85 - 140
	Introduction Technical Terms Royalty Landlord	

	<p>Tenant</p> <p>Minimum Rent</p> <p>Short Workings</p> <p>Recoupment of Short Working</p> <p>Fixed Period</p> <p>Floating Period</p> <p>Recoupment within the Life of a Lease</p> <p>Treatment of Strike</p> <p>Stoppage of Work and Sub-lease</p> <p>Accounting Treatment in the Books of Lessee(tenant)</p> <p>When Royalty is Less than Minimum Rent</p> <p>When Royalty is Equal to Minimum Rent,</p> <p>When the Right of Recoupment is Lost</p> <p>When Minimum Rent Account Method is Followed</p> <p>Passing Journal Entries and Preparation of Ledger Accounts</p> <p>Royalty Account</p> <p>Landlord Account</p> <p>Short workings Account</p> <p>Minimum Rent Account</p> <p>Review Questions</p> <p>Practical Problems <i>with Answer</i></p>	
<b>UNIT - 4</b>	<b>SALE OF THE PARTNERSHIP FIRM</b>	<b>141 - 184</b>
	<p>Introduction</p> <p>Need for Conversion</p> <p>Meaning of Purchase Consideration</p> <p>Methods of Calculating Purchase Consideration</p> <p>Net Payment Method</p> <p>Net Asset Method</p> <p>Passing of Journal Entries</p> <p>Preparation of Ledger Accounts in the Books of Vendor</p> <p>Treatment of Certain Items</p> <p>Dissolution Expenses</p> <p>Unrecorded Assets and Liabilities</p> <p>Assets and Liabilities not Taken Over by the Purchasing Company</p> <p>Contingent Liabilities</p> <p>Non-assumption of Trade Liabilities</p>	

Passing of Incorporation Entries  
Fresh Issue of Shares and Debentures to Meet Working Capital  
Preparation of Balance Sheet as per  
'Companies Act' 2013, under Vertical Format.  
Review Questions  
Practical Problems *with Answer*

**UNIT - 5**

**ACCOUNTING FOR JOINT VENTURES**

**185 - 222**

Introduction  
Meaning of Accounting for Joint Ventures  
Objectives of Accounting for Joint Ventures  
Distinction between Joint Venture and Consignment  
Distinction between Joint Venture and Partnership  
Maintenance of Accounts in the Books of Coverturers  
Maintaining Separate Books for Joint Venture  
Problems on Accounting for Joint Ventures  
Review Questions  
Practical Problems *with Answer*

**BUSINESS LAB ACTIVITIES**

**223 - 232**

# 1 UNIT

## INTRODUCTION TO IFRS

### *Unit Syllabus*

Need for IFRS, Features of IFRS, Applicability of IFRS,  
Beneficiaries of Convergence with IFRS (theory only).

# INTRODUCTION TO IFRS

## INTRODUCTION TO ACCOUNTING STANDARDS (AS)

The use of the word 'standard' in accounting literature is of a recent origin what is described as 'standard' today, used to be generally known as 'principles' a few years ago. The British introduced the term 'standards' in place of 'principles'. We know that financial statements are prepared to summarize the end-result of all the business activities by an enterprise during an accounting period in monetary terms.

To compare the financial statements of various reporting enterprises poses some difficulties because of the divergence in the methods and principles adopted by these enterprises in preparing their financial statements. In order to make these methods and principles uniform and comparable to the extent possible standards are evolved and today there exist different sets of accounting standards which are followed by different countries mean to say respective countries use their own standards for accounting practice.

"Standards" in accounting literature used to be generally known as principles a few years back. Standards are considered to be written statements issued by various professional and expert institutes.

"A standard is an agreed upon criteria of what is proper practice in a given situation; a basis for comparison and judgment; a point of departure when variation is justifiable by the circumstances and reported as such. Standards are not designed to confine practice within rigid limits but rather to serve as guide posts to truth, honesty and fair dealing. They are not accidental but intentional in origin: they are expected to be expressive of the deliberately chosen policies of the highest types of businessmen and the most experienced accountants. They direct a high but attainable level of performance, without precluding justifiable departures and variations in the procedures employed". - *Littleton*

## ACCOUNTING CONCEPTS, CONVENTIONS AND PRINCIPLES

The accounting information is published in the form of financial statements. The three basic financial statements are -

1. The Profit & Loss Account that shows net business result i.e. profit or loss for a certain periods.
2. The Balance Sheet that exhibits the financial strength of the business as on a particular dates.
3. The Cash Flow Statement that describes the movement of cash from one date to the other.

As these statements are meant to be used by different stakeholders, it is necessary that the information contained therein is based on definite principles, concrete concepts and well accepted convention.

Accounting principles are basic guidelines that provide standards for scientific accounting practices and procedures. They guide as to how the transactions are to be recorded and reported. They assure uniformity and understandability. Accounting concepts lay down the foundation for accounting principles. They are ideas essentially at mental level and are self-evident. These concepts ensure recording of financial facts on sound bases and logical considerations. Accounting conventions are methods or procedures that are widely accepted. When transactions are recorded or interpreted, they follow the conventions. Many times, however, the terms-principles, concepts and conventions are used interchangeably.

Professional Accounting Bodies have published statements of these concepts. Over the years, many of these concepts are being challenged as outdated. Yet, no major deviations have been observed. Path breaking ideas have emerged and the accounting standards of modern days do require to record and report transactions which may not be necessarily based on concepts that are in vogue for a long time. It is essential to study accounting from the basic levels and understand these concepts in depth.

**Theory Base of Accounting**

<b>Basic Assumptions</b>	<b>Basic Principles</b>	<b>Modifying Principles</b>
1. Business Entity Concept	1. Revenue Realization Concept	1. Materiality Concept
2. Going Concern Concept	2. Matching Concept	2. Consistency Concept
3. Money Measurement Concept	3. Full Disclosure Concept	3. Conservatism Concept
4. Accounting Period Concept	4. Dual Aspect Concept	4. Timeliness Concept
5. Accrual Concept	5. Verifiable Objective Evidence Concept	5. Industry Practice Concept
	6. Historical Cost Concept	
	7. Balance Sheet Equation Concept	

**GENERALLY ACCEPTED ACCOUNTING PRINCIPLES (GAAP)**

A widely accepted set of rules, conventions, standards and procedures for reporting financial information, as established by the Financial Accounting Standards Board are called Generally Accepted Accounting Principles. These are the common set of accounting principles, standards and procedures that companies use to compile their financial statements. GAAP are a combination of standards and simply the commonly accepted ways of recording and reporting accounting information. GAAP is to be followed by companies so that investors have an optimum level of consistency in the financial statements they use when analyzing companies for investment purposes. GAAP cover such aspects like revenue recognition, balance sheet item classification and outstanding share measurements.

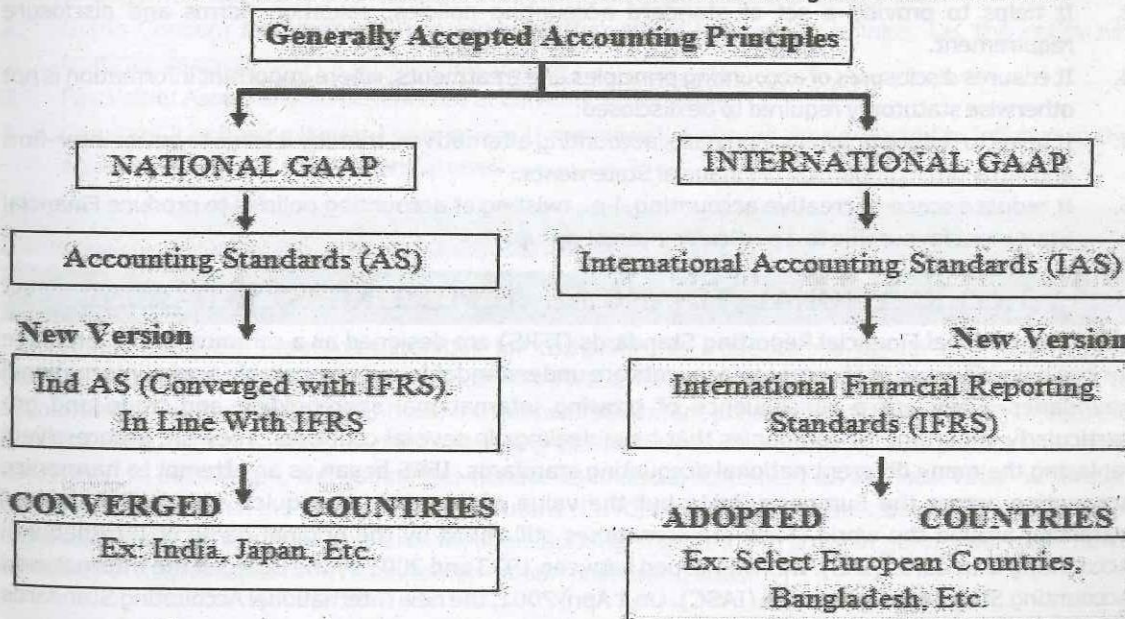
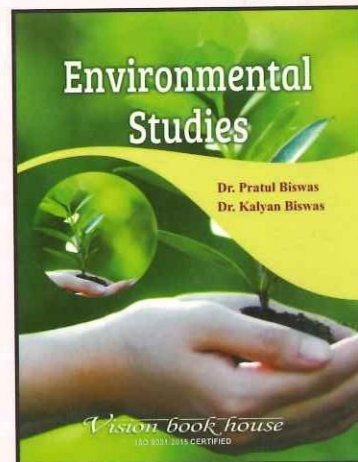
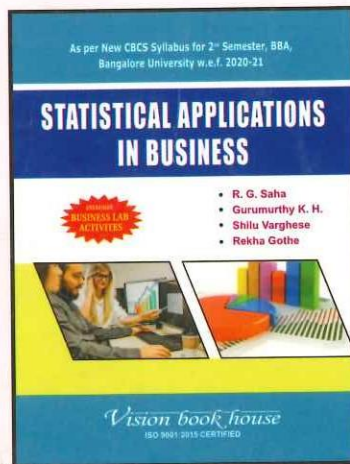
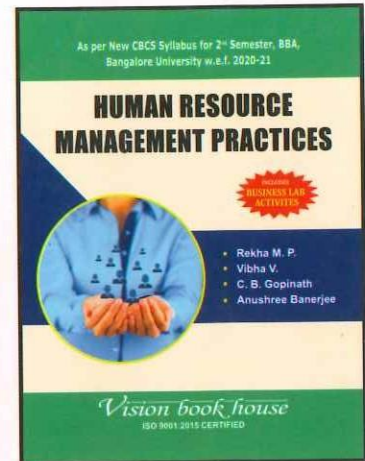
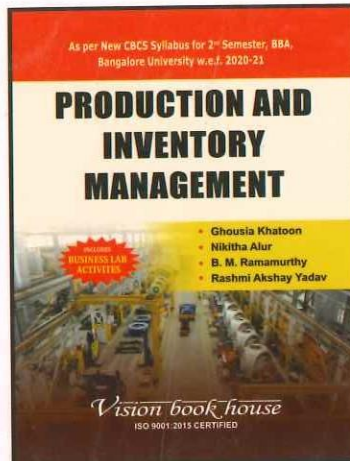
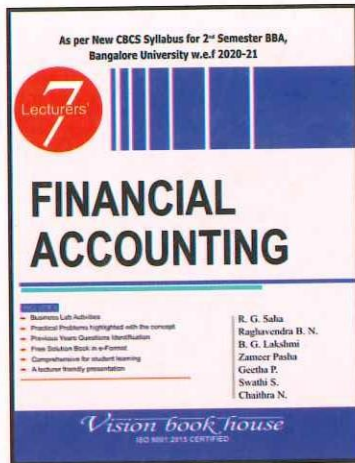


Fig: Different Types of Accounting Standards



# OUR OUTSTANDING PUBLICATIONS



ISBN: 978-93-5433-864-9



9 789354 338649

**For Solution Book:**

✉ Email: [visionblr@gmail.com](mailto:visionblr@gmail.com)

📞 WhatsApp: 9342824929

ISBN: 978-93-5433-864-9

PAB 0178

₹ 245/-



**SURANA COLLEGE**  
(Autonomous)

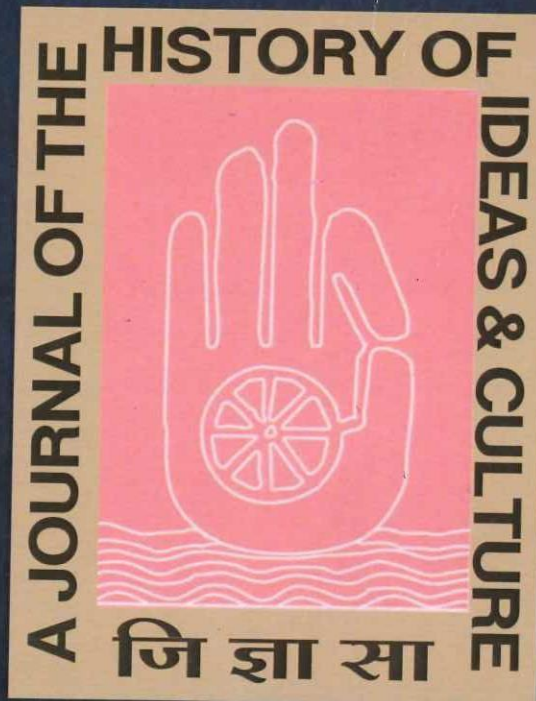
ISO Certified | NAAC A+ Grade  
16, South End Road, Bangalore 560004  
Tel: 080-26642292 | 080-22446141  
www.suranacollege.edu.in

जि ज्ञा सा  
**JIJÑĀSĀ**

A Journal of the History of Ideas & Culture

Volume : XXXVIII

2021



Department of History and Indian Culture  
University of Rajasthan, Jaipur, India

# ***JIJÑĀSĀ***

**A Journal of the History of Ideas and Culture**

**Vol. XXXVIII. 2021**

**A Peer-reviewed /Refereed National Journal**

**ISSN : 0337-743-X**

# **JIJÑĀSĀ**

**A Journal of the History of Ideas and Culture**

**Vol. XXXVIII. 2021**

**A Peer-reviewed/Refereed National Journal**

**ISSN : 0337-743-X**

Editor

**Dr. Pramila Poonia**

Head, Department of History & Indian Culture

University of Rajasthan

Associate Editors

**Dr. Sangeeta Sharma**

**Dr. Neekee Chaturvedi**

Associate Professors

Assistant Editors

**Dr. Anil Aaniket**

**Dr. Ritu Punia**

**Ms. Vandana Agarwal**

Assistant Professors

Managing Editors

**Dr. Nirmala Kumari Meena**

**Mr. Tamegh Panwar**

Assistant Professors



**Department of History and Indian Culture**

**University of Rajasthan**

**Jijñāsā** : A Journal of the History of Ideas and Culture  
Vol. XXXVIII. 2021

Editor : **Dr. Pramila Poonia**

A Peer-reviewed/Refereed National Journal  
ISSN : 0337-743-X

**Editorial Advisory Board**

Prof. S.N. Dubey, Jaipur  
Prof. Sita Ram Dubey, Varanasi  
Prof. J.K. Sharma, Chandigarh  
Prof. Susmita Pande, Bhopal  
Prof. Vibha Upadhyaya, Jaipur

Published by

**Department of History and Indian Culture  
University of Rajasthan**

Jaipur-302004, INDIA

Email- editor.jijnasa@gmail.com

Printed by

**Literary Circle**

## SECURITY ANALYSIS AND PORTFOLIO MANAGEMENT WITH EFFECT OF VARIOUS MARKET FLUCTUATIONS

**Dr.B.G.Prasanthi**, Assistant Professor, St. Joseph's college

**Dr.B.G.Lakshmi** Assistant Professor, Surana College

**Dr.Mini.K.Abraham**, Associate Professor, Surana College

**Mahalakshmi A.L.**, Assistant Professor, Surana College

### 1. ABSTRACT

Security analysis is a method which helps to calculate the value of various assets and also find out the effect of various market fluctuations on the value of tradable financial instruments. The analysis of various tradable financial instruments is called security analysis. Security analysis helps a financial expert or a security analyst to determine the value of assets in a portfolio. The art of selecting the right investment policy for the individuals in terms of minimum risk and maximum return is called as portfolio management. Portfolio management refers to managing an individual's investments in the form of bonds, shares, cash, mutual funds etc so that he earns the maximum profits within the stipulated time frame. Portfolio management refers to managing money of an individual under the expert guidance of portfolio managers. In a layman's language, the art of managing an individual's investment is called as portfolio management. Portfolio management presents the best investment plan to the individuals as per their income, budget, age and ability to undertake risks. Portfolio management minimizes the risks involved in investing and also increases the chance of making profits. Portfolio managers understand the client's financial needs and suggest the best and unique investment policy for them with minimum risks involved. Portfolio management enables the portfolio managers to provide customized investment solutions to clients as per their needs and requirements.

### 2. OBJECTIVES OF THE STUDY

- To Know the overall concept of the portfolio management.
- To find out the various factors that an investor should take into consideration to make proper investment decisions.
- To do an in detailed analysis of the risk and return characteristics of stocks related to and different companies.
- To help the investors to decide the effective portfolio of securities.
- To identify the best portfolio of securities

### 3. NEED OF THE STUDY

- The basic importance need of the study of portfolio management is to protect and secure the investors investment by providing at most valuable profitable decisions to be given to the investors.
- To know about portfolio management is a decision support system that is designed with a view to meet the multi-faced needs of investors.
- To know about national-level solution with access to multiple markets by providing high cost-effective service to investors across the country.
- Create a liquid and vibrant national-level market for all listed companies in general and small capital companies in particular.
- Optimally utilizing the existing infrastructure and other resources of participating Stock Exchanges, which are under-utilized now.
- Provide a level playing field to small Trading Members by offering opportunity to participate in a national market for investment- oriented business.

- Provide clearing and settlement facilities to the Trading members across the country at their doorstep in a decentralized mode

#### 4. SCOPE OF THE STUDY

The scope of the project is to study and know about online Trading and clearing & Settlements dealt in inter-connected stock exchange. By studying the online Trading and clearing & settlements, a clear option of dealing in Stock exchange is been understood. Unlike olden days the concept of trading manually Is been replaced for fast interaction of shares of shareholder. By this we can access anywhere and know the present dealings in shares

#### 5. LIMITATIONS OF THE STUDY

- The study confines to the past 5 years and present system of the trading procedure in The ISE and the study is confined to the coverage of all the related issues in brief.
- The Data is collected from the primary and secondary sources and thus is subject to slight Variation than what the study includes in reality.
- Hence accuracy and correctness can be measured only to the extend of what the Sample group has furnished.

#### 5.1 Data collection methods

- Primary collection methods: This method includes the data collection from the personal discussion with the authorized clerks and members of the exchange.
- Secondary collection methods: The secondary collection methods includes the lectures of the superintendent of the department of market operations and so on ., also the data collected from the news, magazines, of the ISE and different books issues of this study.

#### 5.2 Calculation of Average Returns of the Companies

$$\text{Average Return} = (R)/N$$

#### INFOSYS

Years	Divine d	Opening Share Price(P)	Closing Share Price(P1)	D+(P1-P0)	D+(P1-P0)/P0*100
2013-2014	940	2763.9	2318.5	496.6	17.967
2014-2015	940	2325.1	3485.5	2100.4	90.335
2015-2016	1460	3491	1971.2	-59.8	-1.712
2016-2017	790	1967.8	1104.55	-73.25	-3.722
2017-2018	505	1100	1010.7	415.7	37.79
Total Return					140.658

$$\text{Average return} = 140.65/5 = 28.13$$

#### TORRENT

Years	Divined	Opening Share Price(P)	Closing Share Price(P1)	D+(P1-P0)	D+(P1-P0)/P0*100
2013-2014	170	545.3	712.45	337.15	61.828351
2014-2015	120	726	469.9	-136.1	-18.746556
2015-2016	200	472.05	1100	827.95	175.39455
2016-2017	225	1125	1441.1	541.1	48.097777
2017-2018	700	1459.9	1287.1	527.2	36.112062
Total Return					302.68619

**JINDAL STEEL**

Years	Divined	Opening Share Price(P)	Closing Share Price(P1)	D+(P1-P0)	D+(P1-P0)/P0*100
2013-2014	75	457	447.5	65.5	14.332603
2014-2015	100	450.9	260.95	-89.95	- 19.948991
2015-2016	110	262.15	151.85	-0.3	- 0.1144383
2016-2017	110	152.1	96.1	54	35.502958
2017-2018	75	96.2	69.1	47.9	49.792099
Total Return					79.564233

Average return = 79.56/5=15.912

**ACC CEMENTS**

Years	Divined	Opening Share Price(P)	Closing Share Price(P1)	D+(P1-P0)	D+(P1-P0)/P0*100
2013-2014	280	1145	1432	567	49.519650
2014-2015	300	1440	1108.75	-31.25	- 2.170138
2015-2016	340	1110	1400.15	630.15	56.770270
2016-2017	300	1400.15	1360.65	260.5	18.605149
2017-2018	170	1340	1331.05	161.05	12.018656
Total Return					134.74358

Average return=134.74/5=26.95

**BHARATH HEAVY ELECTRICALS LTS**

Years	Divined	Opening Share Price(P)	Closing Share Price(P1)	D+(P1-P0)	D+(P1-P0)/P0*100
2013-2014	320	159.8	152.13	312.33	195.45056
2014-2015	270.5	157.2	117.47	230.77	146.80025
2015-2016	141.5	118.17	178	201.33	170.37319
2016-2017	58	177.07	113	-6.07	- 3.428022
2017-2018	20	112.67	80.63	-12.04	- 10.68607
Total Return					498.50991

Average return = 498.50/5=99.7

**DLF LTD**

Years	Divined	Opening Share Price(P)	Closing Share Price(P1)	D+(P1-P0)	D+(P1-P0)/P0*100
2013-2014	100	184.7	229.8	145.1	78.559826
2014-2015	100	237.1	166.5	29.4	12.399831
2015-2016	100	167.6	137.7	70.1	41.825775
2016-2017	100	137	116	79	57.664233
2017-2018	100	115.95	111	95.05	81.974989
Total Return					272.42465

Average return = 272.42/5=54.49



INFOSYS(IT)	28.13
TORRENT(PHARMACY)	60.536
JINDAL(STEEL&POWER)	15.912
ACC(CEMENTS)	26.95
BHEL(ELECTRONICS)	99.7
DLF(REAL ESTSTES)	54.49

**6. STANDARD DEVITATION**

Variance =  $1/n-1(R-R)^2$

Standard Deviation= variance

**INFOSYS:**

Years	Return	Average Return®	R-R	R-R
2013-2014	17.967	28.13	-10.163	103.28657
2014-2015	90.335	28.13	62.205	3869.462
2015-2016	-1.712	28.13	-29.842	890.54496
2016-2017	-3.722	28.13	-31.852	1014.5499
2017-2018	37.79	28.13	9.66	93.3156
Total Return				5971.1591

Variance= $1/n-1(R-R)^2=1/5-1(5971.1591)=-5970.9$

Standard Deviation= $\sqrt{\text{variance}} = \sqrt{5970.9} = 77.271$

**TORRENT:**

Years	Return	Average Return®	R-R	R-R
2013-2014	61.828	60.536	-1.292	1.669264
2014-2015	-17.846	60.536	78.382	6143.737
2015-2016	175.394	60.536	-114.858	13192.36
2016-2017	48.097	60.536	12.439	154.7287
2017-2018	36.112	60.536	24.424	596.5317
Total Return				20089.02

Variance= $1/n(R-R)^2=1/5-1(20089.028)=-20088.828$

Standard deviation=  $\sqrt{\text{varianc}} = \sqrt{20088.828} = 141.735$

**JINDAL STEEL&POWER LTD:**

Years	Return	Average Return®	R-R	R-R
2013-2014	14.33	15.912	-1.5794	2.494504
2014-2015	-19.94	15.912	-35.8609	1286.004
2015-2016	-0.11	15.912	-16.0264	256.8455
2016-2017	35.50	15.912	19.5909	383.8033
2017-2018	49.79	15.912	33.88	1147.854
Total Return				3077.001

$\text{variance} = 1/n - 1(R-R)^2 = 1/5 - 1(3077.0019) = -3076.8019$   
 $\text{standard deviation} = \sqrt{\text{variance}} = \sqrt{3076.8019} = 55.4689$

**ACC:**

Years	Return	Average Return®	R-R	R-R
2013-2014	49.519	26.95	22.5696	509.3868
2014-2015	-2.1701	26.95	-29.1201	847.9802
2015-2016	56.770	26.95	29.8202	889.2443
2016-2017	18.605	26.95	-8.3449	69.63735
2017-2018	12.018	26.95	-14.9314	222.9467
Total Return				2539.195

$\text{variance} = 1/n - 1(R-R)^2 = 1/5 - 1(2539.1955) = -2538.9955$   
 $\text{standard deviation} = \sqrt{\text{variance}} = \sqrt{2538.9955} = 50.3904$

**BHEL**

Years	Return	Average Return®	R-R	R-R
2013-2014	195.45	99.7	95.7505	9168.158
2014-2015	146.80	99.7	47.1002	2218.428
2015-2016	170.37	99.7	70.6731	4994.687
2016-2017	-3.44	99.7	-103.128	10635.38
2017-2018	-10.686	99.7	-110.386	12185.06
Total Return				39201.72

$\text{variance} = 1/n - 1(R-R)^2 = 1/5 - 1(39201.728) = -39201.528$   
 $\text{standard deviation} = \sqrt{\text{variance}} = \sqrt{39201.728} = 197.9942$

**DLFLTD**

Years	Return	Average Return®	R-R	R-R
2011-2012	78.559	54.49	24.0698	579.3552
2012-2013	12.399	54.49	-42.0902	1771.584

2015-2016	41.825	54.49	-12.6643	160.3844
2016-2017	57.664	54.49	3.1742	10.07554
2017-2018	81.974	54.49	27.4849	755.4197
Total Return				3276.82

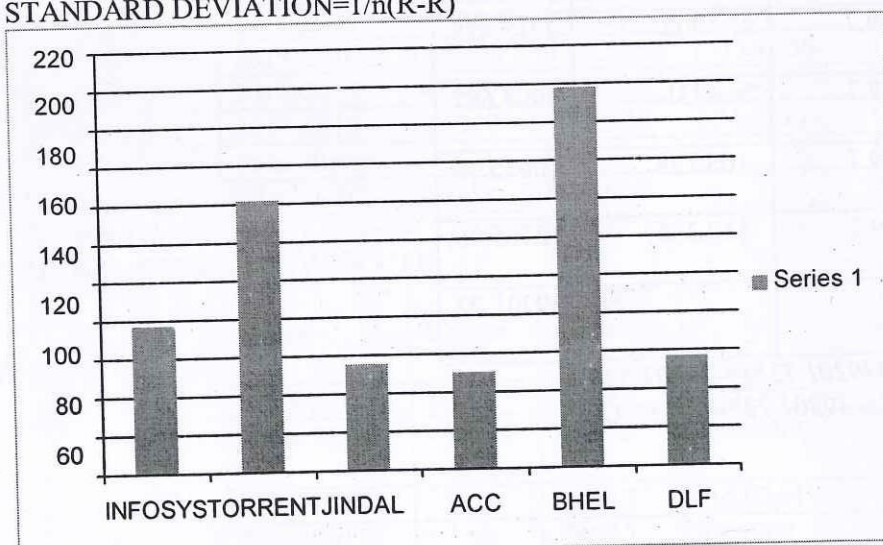
$$\text{variance} = 1/n-1(R-R)^2 = 1/5-1(3276.82) = -3276.62$$

$$\text{standard deviation} = \sqrt{\text{variance}} = \sqrt{3276.82} = 57.2435$$

#### STANDARD DEVIATION OF COMPANIES

INFOSYS	77.271
TORRENT	141.735
JINDAL	55.4689
ACC	50.3904
BHEL	197.994
DLF	57.2435

STANDARD DEVIATION =  $1/n(R-R)$



#### 7. PORTFOLIO RISK

S.NO	COMBINATION	PORTFOLIO RISK
1	INFOSYS & TORRENT	40.72
2	INFOSYS & JINDAL	27.37

3	INFOSYS&ACC	14.18
4	INFOSYS&BHEL	27.39
5	INFOSYS&DLF	30.74
6	TORRENT&JINDAL	88.22
7	TORRENT&ACC	97.26
8	TORRENT&BHEL	34.43
9	TORRENT&DLF	85.32
10	JINDAL&ACC	14.97
11	JINDAL&BHEL	23.02
12	JINDAL&DLF	20.09
13	ACC&BHEL	24.34
14	ACC&DLF	23.33
15	BHEL&DLF	10.61

### 7.1 Calculation Of Portfolio risk

$$RP = a \sqrt{a^2 * wa^2 * wa^2 + b^2 * wb^2 * wb^2 + 2nab * a * b * wa * wb}$$

Where a=std deviation of security a b=std deviation of security b  
 wa=weight of security a  
 wb=weight of security b  
 Nab=correlation coefficient between security a&b  
 a=portfolio risk

### 7.2 Portfolio return

FORMULA

$$RP = (Ra * wa) + (Rb * wb); \text{ Where}$$

Rp=portfolio return

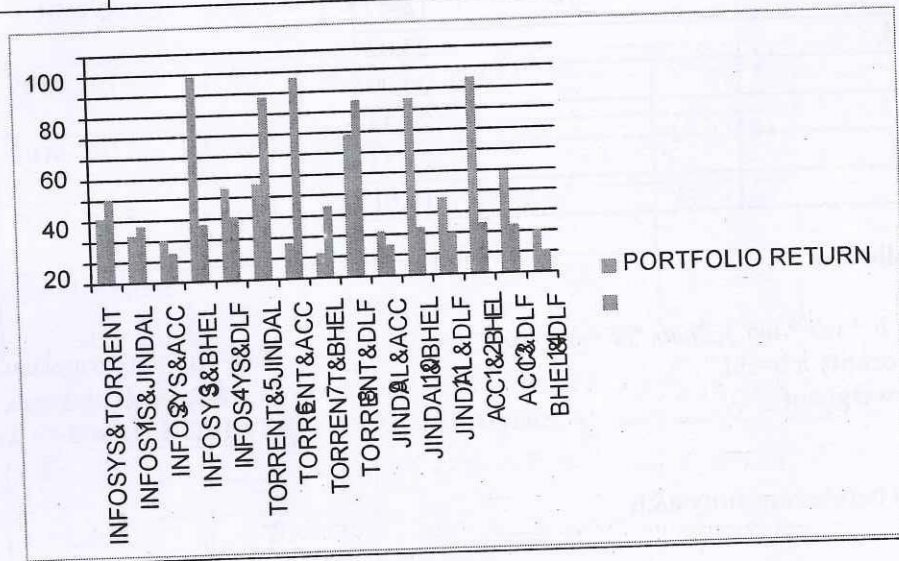
Ra=Average return on security a;

Rb=Average return on security b

Wa=weight of security a; Wb=weight of security b;

S.NO	COMBINATION(A&B)	PORTFOLIO RETURN	PORTFOLIO RISK
1	INFOSYS&TORRENT	31.25	40.72
2	INFOSYS&JINDAL	22.84	27.37
3	INFOSYS&ACC	20.36	14.18
4	INFOSYS&BHEL	98.81	27.39
5	INFOSYS&DLF	44.57	30.74
6	TORRENT&JINDAL	46.35	88.22
7	TORRENT&ACC	17.35	97.26
8	TORRENT&BHEL	11.96	34.43
9	TORRENT&DLF	68.83	85.32
10	JINDAL&ACC	21.58	14.97
11	JINDAL&BHEL	85.54	23.02

12	JINDAL&DLF	36.98	20.09
13	ACC&BHEL	95.08	24.34
14	ACC&DLF	49.4	23.33
15	BHEL&DLF	20.4	10.61



**8. INTERPRETATION**

Showing the above chart between both the INFOSYS AND BHEL is more appropriate it has more growth compared to other. Among INFOSYS TORRENT JINDAL ACC BHEL DLF Companies has performed better in the market

**9. FINDINGS**

1. Among Infosys, Torrent, Jindal, Acc, Bhel, Dlf, companies has performed better in the market.
2. Among BHEL&DLF companies has poor performed in the market.
3. Between both the Torrent & Dlf , is more appropriate it has more growth Compared tother
4. it is advisable to select the Torrent &Dlf, because its high growth.
5. As per my knowledge BHEL&DLF, with a better and opting for changes Based upon the market fluctuation. Under the eyes of efficient manager can Produce a high return with a low risk under any circumstances .INFOSYS& ACC, has doing the same way.

**10. WEB REFERENCES:**

- <http://www.nseindia.com>
- <http://www.bse.india.com>
- <http://www.investsmart india.com>
- <http://www.rediffmoney.com>

ISSN : 0337-743-X

As per New Education Policy (NEP) Karnataka

# DIGITAL FLUENCY



- Suman M.
- Chinmaya Dash
- R. Sreenivas Rao

*Vision book house*

ISO 9001:2015 CERTIFIED

# DIGITAL FLUENCY

---

**Suman M.** B.Sc., MCA, MBA  
Technical Manager,  
Technodesk Australia, Sydney.

**Chinmaya Dash** MCA, (Ph.D)  
Asst. Prof., Department of Computer Science,  
St. Claret College, Bengaluru.

**R. Sreenivas Rao** M.Sc. (CS), M.Sc. (Maths)  
Asst. Prof., Department of Computer Science,  
Surana College, Bengaluru.

With Best Compliments from :  
HIMALAYA PUBLISHING HOUSE PVT. LTD.



*Vision book house* \*\*

NEW DELHI • BANGALORE

*(\*\* An Imprint of Himalaya Publishing House Pvt. Ltd.)*



# OUR OUTSTANDING PUBLICATIONS

As per NEP Syllabus

## First Semester, B.Com.

- Financial Accounting
- Management Principles and Applications
- Principles of Marketing
- Digital Fluency
- Accounting for Everyone
- Basics of Computer
- Financial Literacy

## First Semester, BBA

- Management Principles and Practice
- Fundamentals of Business Accounting
- Marketing Management
- Digital Fluency
- Business Organisation
- Office Organisation and Management

ISBN: 978-93-5495-474-0



ISBN: 978-93-5495-474-0

PSM 0879

₹ 210/-

As per New Revised Syllabus w.e.f. 30.12.2021  
for Bengaluru City University

# DIGITAL FLUENCY



**Includes  
MCQs**

- Dr. R. G. Saha
- R. Sreenivas Rao
- Niha Asif

**Himalaya Publishing House**

ISO 9001:2015 CERTIFIED

# DIGITAL FLUENCY

---

*[As per New Revised NEP Syllabus w.e.f 2021-22]*

## **Dr. R. G. Saha**

MBA, M.Com., M.Sc(IT), M.Phil, Ph.D(fin.), Ph.D(mkt.)  
Former Associate Prof. & HOD, KKECS Institute of Management,  
Visiting Professor to various B-Schools  
Founder, Vision Book House, Proprietor, Archita Education, Bengaluru.

## **R. Sreenivas Rao**

M.Sc. (CS), M.Sc. (Maths)  
Asst. Prof., Department of Computer Science,  
Surana College, Bengaluru.

## **Niha Asif**

M.Com., MBA, PGDMM, PGDE, NET, (Ph.D)  
Asst. Professor, Department of Commerce and Management,  
St. Joseph's College (Autonomous), Bengaluru.

*With Best Compliments from:*  
**HIMALAYA PUBLISHING HOUSE PVT. LTD.**



# Himalaya Publishing House

ISO 9001:2015 CERTIFIED

# ***OUR OUTSTANDING PUBLICATIONS***

**As per NEP Syllabus**

## **First Semester, B.Com.**

- Financial Accounting
- Management Principles and Applications
- Accounting for Everyone
- Financial Literacy
- Digital Fluency
- Principles of Marketing

## **First Semester, BBA**

- Management Principles and Practice
- Fundamentals of Business Accounting
- Marketing Management
- Digital Fluency
- Business Organisation
- Office Organisation and Management

[www.himpub.com](http://www.himpub.com)



ISBN: 978-93-5495-571-6

PSM 0892

₹ 250/-

## A Facile method for the synthesis of pyrroles and pyridines

Chemistry has had a significant influence on society. It is inextricably related to humanity's well-being. The rate of progress in chemistry is so rapid that the curriculum and the subject experts are always looking for new ways to deal with it. Students and the readers must also be motivated to become excellent researchers in the field of science and technology who can make significant contributions to society and the upliftment of mankind. This book is a genuine attempt at this approach to imbuing the scientific culture among readers by enriching them with knowledge simply and lucidly.

Dr. Sumaiya Tabassum is currently the HOD, Department of Chemistry, Surana College, Bangalore. Prof. Vijayasankar is the HOD, Department of Sciences and Humanities (CHRIST Deemed to be University) and Dr. Santhosh G, Assistant Professor, Department of Sciences and Humanities (CHRIST Deemed to be University).

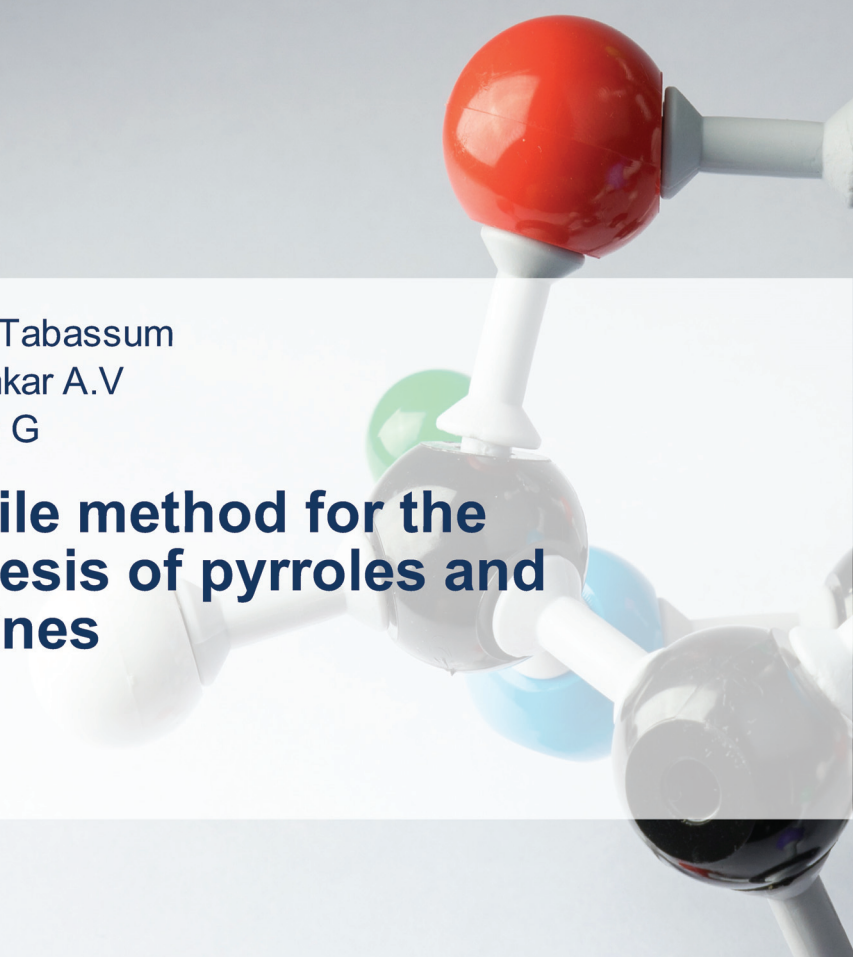


**Scholars'  
Press**

Sumaiya Tabassum  
Vijayasankar A.V  
Santhosh G

**A Facile method for the  
synthesis of pyrroles and  
pyridines**

FOR AUTHOR USE ONLY



**Sumaiya Tabassum  
Vijayasankar A.V  
Santhosh G**

**A Facile method for the synthesis of pyrroles and pyridines**

FOR AUTHOR USE ONLY

FOR AUTHOR USE ONLY

**Sumaiya Tabassum  
Vijayasankar A.V  
Santhosh G**

# **A Facile method for the synthesis of pyrroles and pyridines**

FOR AUTHOR USE ONLY

**Scholars' Press**



**Imprint**

Any brand names and product names mentioned in this book are subject to trademark, brand or patent protection and are trademarks or registered trademarks of their respective holders. The use of brand names, product names, common names, trade names, product descriptions etc. even without a particular marking in this work is in no way to be construed to mean that such names may be regarded as unrestricted in respect of trademark and brand protection legislation and could thus be used by anyone.

Cover image: [www.ingimage.com](http://www.ingimage.com)

Publisher:

Scholars' Press

is a trademark of

Dodo Books Indian Ocean Ltd., member of the OmniScriptum S.R.L  
Publishing group

str. A.Russo 15, of. 61, Chisinau-2068, Republic of Moldova Europe

Printed at: see last page

**ISBN: 978-3-330-65264-4**

Copyright © Sumaiya Tabassum, Vijayasankar A.V, Santhosh G

Copyright © 2022 Dodo Books Indian Ocean Ltd., member of the  
OmniScriptum S.R.L Publishing group

FOR AUTHOR USE ONLY

## CONTENTS

Introduction.....	2
Importance of the 3 <i>H</i> -pyrroles and pyridines .....	2
References .....	45

FOR AUTHOR USE ONLY

# Facile synthesis of uniquely decorated 3*H*-pyrroles and novel pyridines in water

Sumaiya Tabassum<sup>1</sup>, Lokesh Kumar S<sup>2</sup>, Vijayasankar A.V<sup>2</sup> and Santhosh Govindaraju<sup>4\*</sup>

<sup>1</sup>Department of Chemistry, Surana College, South End Road,  
Basavanagudi, Bengaluru 560004. India.

<sup>2</sup>Department of Sciences and Humanities, School of Engineering and Technology, CHRIST (Deemed to be University), Kumbalagodu, Mysore Road,  
Bengaluru 560074. India.

<sup>3</sup>Department of Sciences and Humanities, School of Engineering and Technology, CHRIST (Deemed to be University), Kumbalagodu, Mysore Road,  
Bengaluru 560074. India.

\*Corresponding author: Email: santhosh87org@gmail.com;

## 1. Introduction

This chapter deals with the one-pot synthesis of 2-amino-3-methyl-3*H*-pyrrole-4-carbonitrile and pyridine-3-carbonitrile derivatives, catalyzed by Et<sub>3</sub>N in environmentally benevolent solvent water under reflux.

### 2.1. Importance of the 3*H*-pyrroles and pyridines

#### 2.1.1.1 Importance of the 3*H*-pyrroles

3*H*-Pyrroles represent a little known ring system with a potentially rich chemistry in terms of rearrangement, addition and cycloaddition reactions.<sup>1</sup>

Although other types of pyrrole have been described in the literature, the *3H* compounds, which were positively characterized several years ago, had since received little attention. Some *3H*-Pyrrole compounds showed antimicrobial activity against Gram-positive bacteria while some have antitumor activity.<sup>2</sup>

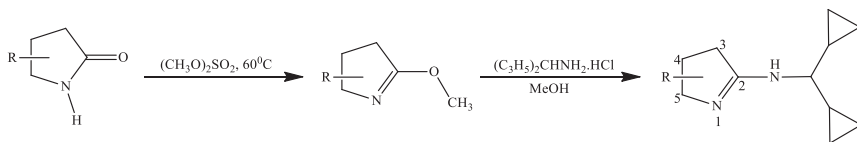
### 2.1.1.2 Importance of the pyridines

Out of the mono-nitrogen containing heterocyclic systems, pyridine enjoys a very special status because of occurrence of its saturated and partially saturated derivatives in biologically active compounds and natural products such as NAD nucleotides, pyridoxol (vitamin B<sub>6</sub>) and pyridine alkaloids.<sup>3</sup> Again, the polysubstituted pyridines including polyaryl pyridines constitute an important and attractive group of compounds in organic synthesis since these products find wide applications in preparative organic chemistry<sup>4,5</sup> and as substrates for the preparation of supramolecules.<sup>6</sup> These compounds have also instigated a rapidly growing interest in recent years as they are endowed with wide range of pharmaceutical activities such as antimalarial, vasodilator, anesthetic, anticonvulsant, antiepileptic and agrochemicals such as fungicidal, pesticidal and herbicidal.<sup>7</sup>

### 2.1.1 Brief review on the synthesis of *3H*-pyrroles and pyridine derivatives

#### 2.1.1.1 A brief review on the synthesis of *3H*-pyrrole derivatives

Unlike *1H*-pyrrole compounds, relatively little attention was paid towards the synthesis of *3H*-pyrroles presumably because of difficulties associated with the synthesis of these compounds. To date, no general synthetic approach to these compounds has been reported. Only a few novel unconventional routes are reported

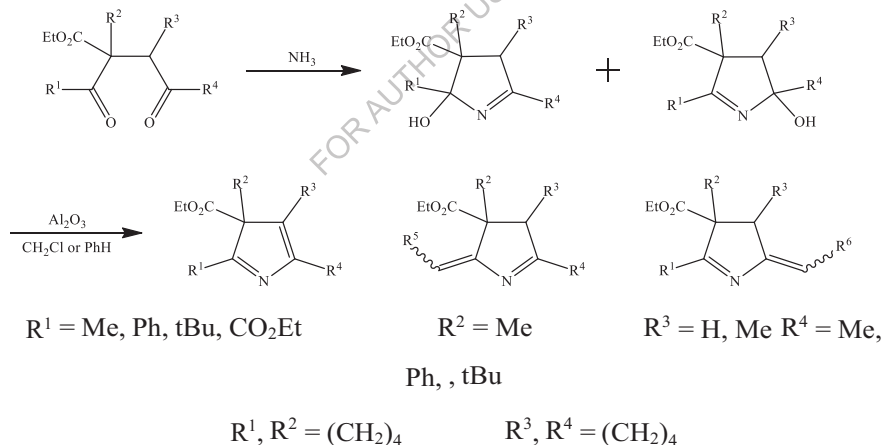


for their syntheses which have been incorporated in this review. S. Schann and his coworkers reported the synthesis of substituted dicyclopropylmethyl-(4,5-dihydro-3*H*-pyrrol-2-yl)-amine derivatives through a multistep coupling reaction of dicyclopropylmethylamine moiety with lactams (Scheme 2.1.2.1.1).<sup>8</sup>

R= H, 3-Me, 4-Me, 5-Me, cis-/trans-4,5-di-Me, 5-Et etc.

### Scheme 2.1.2.1.1

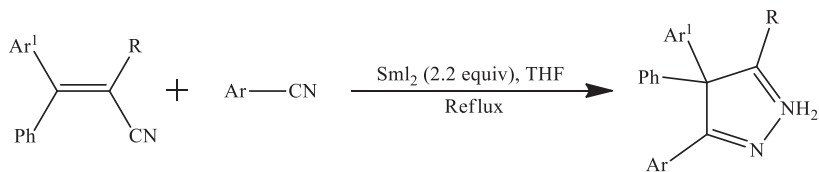
P. K. Chiu and his coworkers outlined the synthesis of 3-Ethoxycarbonyl-3*H*-Pyrroles via the Paal-Knorr reaction followed by sigmatropic rearrangements using suitably substituted 2-ethoxycarbonyl-1,4-diketones with liquid ammonia followed by dehydration of the isolable 2-hydroxy-3,4-dihydro-2*H*-pyrrole intermediates with alumina in boiling solvents (Scheme 2.1.2.1.2).<sup>9</sup>



### Scheme 2.1.2.1.2

X. Xu and his coworkers developed an one-pot, two-component synthesis of 2,3,3-triaryl-3*H*-pyrroles by samarium (II) iodide mediated reductive cyclization of 1,1-

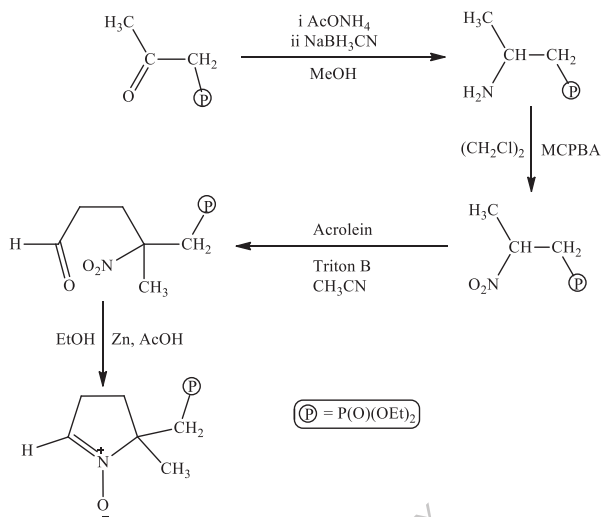
diaryl-2,2- dicyanoethylenes with aromatic nitriles under neutral and mild conditions (Scheme 2.1.2.1.3).<sup>10</sup>



R = CN, CO<sub>2</sub>Et

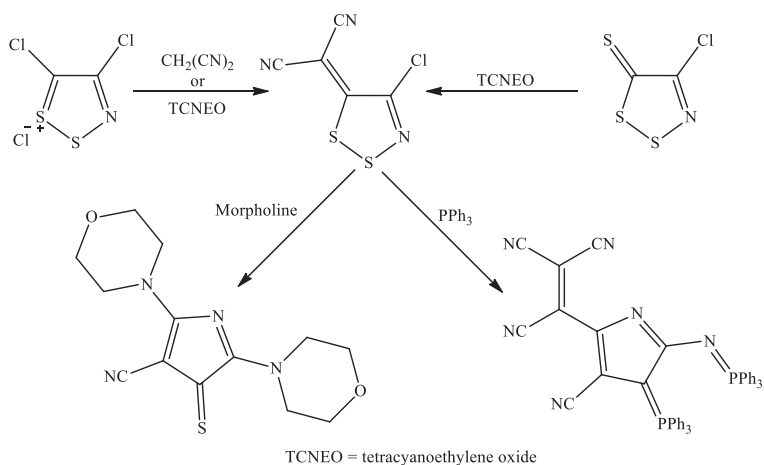
### Scheme 2.1.2.1.3

V. Roubaud and his coworkers invented a four-step synthetic route for the synthesis of 5- (diethoxyphosphorylmethyl)-5-methyl-4,5-dihydro-3*H*-pyrrole-*N*-oxide using diethyl (2- oxopropyl)phosphonate followed by reductive amination with sodium cyanoborohydride in the presence of ammonium acetate to obtain diethyl (2-aminopropyl)-phosphonate. Diethyl (2- aminopropyl)phosphonate on further oxidation, followed by hydrolysis afforded the desired 3*H*- pyrrole *N*-oxide (Scheme 2.1.2.1.4).<sup>11</sup>



#### Scheme 2.1.2.1.4

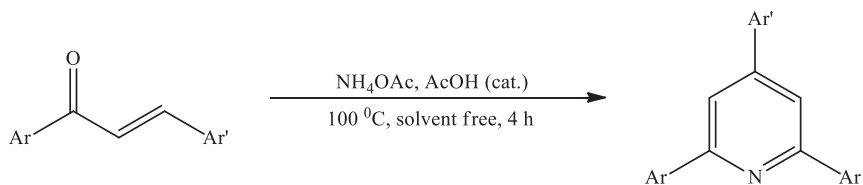
P. A. Koutentis and his coworkers used readily available dicyanomethylenedithiazole with excess of morpholine or triphenylphosphine to give the 3*H*-pyrrole-3-thione and 3*H*-pyrrol-3-ylidenephosphorane respectively in toluene (Scheme 2.1.2.1.5).<sup>12</sup>



### 2.1.1.1 A brief review on the synthesis of pyridine derivatives

There are many ways for achieving the synthesis of pyridines. In this review, some interesting examples have been incorporated based on the synthesis of highly substituted pyridines.

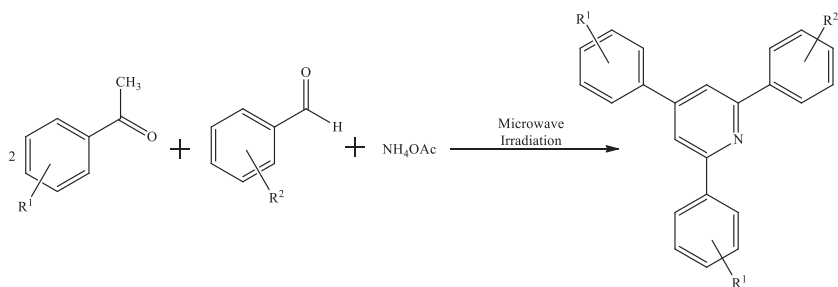
M. Adib and his coworkers described the synthesis of 2,4,6-triarylpyridines from a novel reaction between chalcones and ammonium acetate under solvent-free conditions in excellent yields (Scheme 2.1.2.2.1).<sup>13</sup>



**Scheme 2.1.2.2.1**

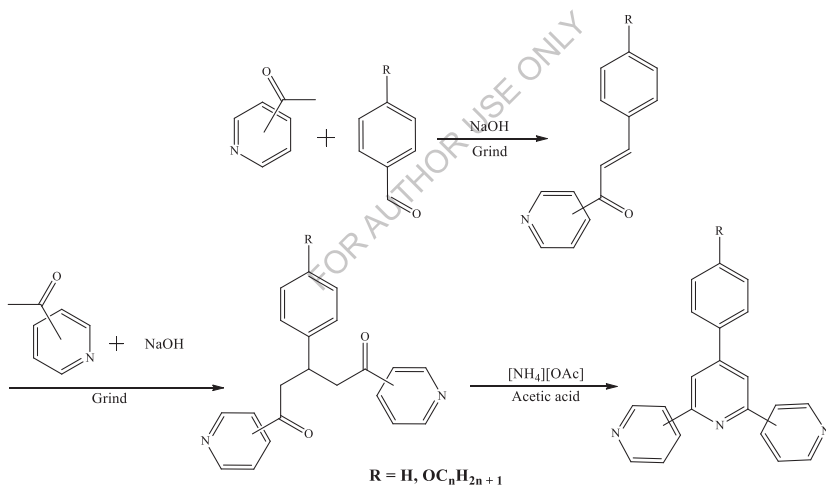
S. Tu and his coworkers synthesized a series of 2,4,6-triarylpyridines by the one-pot reaction of aldehydes with aromatic ketones in the presence of ammonium acetate under microwave irradiation without catalyst (Scheme 2.1.2.2.2).<sup>14</sup>





**Scheme 2.1.2.2**

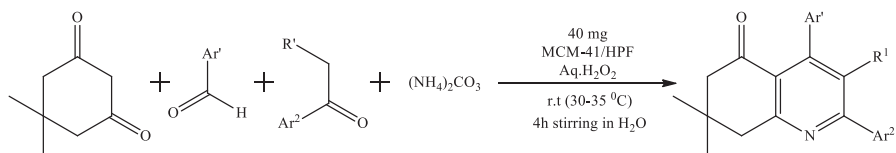
G. W. V. Cave and his coworkers outlined the synthesis of 2,4,6-triarylpyridines by condensation of acetophenones, benzaldehydes and  $\text{NH}_4\text{OAc}$  in the presence of  $\text{NaOH}$  under solvent-free condition (Scheme 2.1.2.2.3).<sup>15</sup>



**Scheme 2.1.2.3**

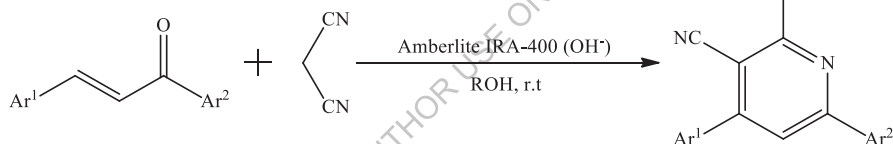
S. Ray and his coworkers carried out the synthesis of pyridine derivatives starting from cyclic- 1,3-diketones, aldehydes, aromatic ketones and ammoniumcarbonate, catalyzed by  $\text{MCM-41/HPF}_6$  at room temperature (Scheme

2.1.2.2.4).<sup>16</sup>



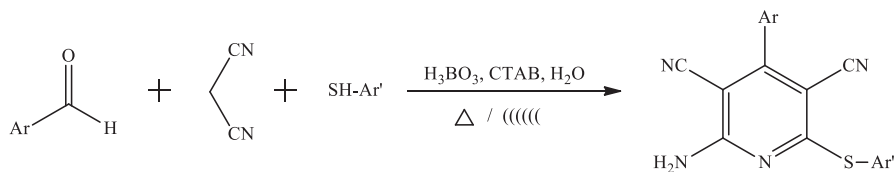
**Scheme 2.1.2.2.4**

K. Bahrami and his group invented a simple, convenient, environmentally benign and mild synthetic method for the synthesis of polysubstituted pyridine derivatives employing a green solvent EtOH or MeOH and Amberlite IRA-400 ( $\text{OH}^-$ ) as catalyst at room temperature by the two-component reaction of  $\alpha,\beta$ -unsaturated ketones and malononitrile (Scheme 2.1.2.2.5).<sup>17</sup>



**Scheme 2.1.2.2.5**

P. V. Shinde and his coworkers synthesized 2-amino-3,5-dicarbonitrile-6-thio-pyridines in aqueous media via a reaction of aldehyde, malononitrile and thiophenol by conventional and ultrasound method (Scheme 2.1.2.2.6).<sup>18</sup>

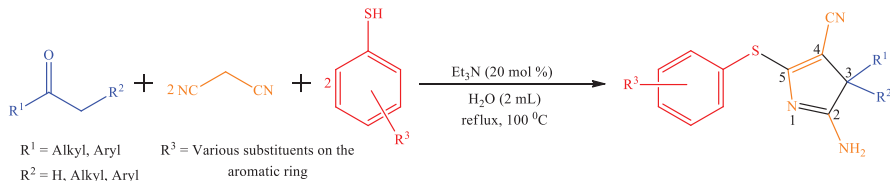


Ar' = Ph, 2-NH2-Ph  
 Ar = 4-Cl-Ph, Ph, 4-F-Ph, 4-OH-Ph, 4-NO2-Ph, 4-Me-Ph, Piperonyl,  
 2-Furfuryl, 2-Thienyl, 4-OH-3-OMe-Ph, 3,4-OMe-Ph

**Scheme 2.1.2.2.6**

## 2.2 Results and Discussion

The one-pot, organocatalyzed, synthesis of 3*H*-pyrroles from ketones, sulphur nucleophile and malononitrile in environmentally benevolent solvent, water has been reported in this chapter of my thesis (Scheme 2.2.1).

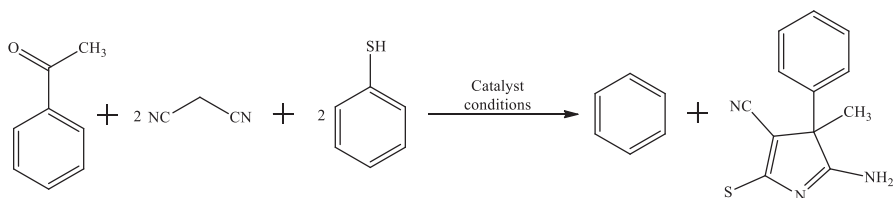


Scheme 2.2.1

Recently “organocatalysis” has emerged as one of the major issues in the development of catalytic chemical technology.<sup>19</sup> Organocatalysis is a reaction carried out by sub-stoichiometric amounts of organic compounds which do not contain even a small amount of enzyme or inorganic element.<sup>20</sup> Although metal catalyzed reactions<sup>21</sup> have wider substrate scope, however, the toxicity of metals can be carried over to the products.<sup>20</sup> Organic compounds as organocatalysts, as compared to metals, are more stable, less expensive, non-toxic, readily available and environmentally friendly. Besides, their stability to moisture and oxygen, does not require air sensitive inconvenient techniques. Thus, the reproducibility and operational simplicity of these reactions are enhanced. Organocatalysts provide better alternatives not only to metal catalysts but also to biocatalysts.<sup>22</sup> Therefore, organocatalysis has recently emerged as a powerful synthetic paradigm to provide practical alternatives to the more traditional transition metal-catalyzed systems.<sup>23</sup>

To optimize the reaction conditions, a series of experiments were conducted with a representative reaction of acetophenone, malononitrile and thiophenol

(Scheme 2.2.2) with variation of reaction parameters, such as catalyst, reaction temperature etc. and the results are summarized in Table 2.2.1.



**Scheme 2.2.2**

Optimization of the reaction conditions for the synthesis of 3*H*-pyrroles No satisfactory yield was obtained with stronger base catalysts and significant tarring was observed (Table 2.2.1, entries 1 and 2) probably due to the self-condensation of the carbonyl compounds at high temperature with stronger bases.<sup>24</sup> Importantly, no product was observed when a background reaction was carried out without any catalyst (Table 2.2.1, entry 3).

Interestingly, the basicity of the common organic bases did not assert any obvious effect on the product yield. However, pyridine and Et<sub>3</sub>N afforded slightly better yield than DBU, guanidine or piperidine presumably due to lesser extent of polymerization of the ketones with weaker bases like pyridine and Et<sub>3</sub>N. However, pyridine is potentially harmful to the experimentalist.<sup>24</sup> Therefore, Et<sub>3</sub>N was our obvious choice of catalyst. Again, temperature played a significant role since there was only 62% yield at 60 °C compared to 94% yield at 100 °C (Table 2.2.1, entries 7 and 8). Albeit the reaction was successful in common high boiling organic solvents like toluene, DMSO, DMF etc., the isolated yields were comparatively low (Table 2.2.1, entries 10-12). The reaction in low boiling solvents (MeOH, DCM) afforded poor yields of 2.2.1a (Table 2.2.1, entries 15, 16). However, comparatively better yields were obtained in ACN and EtOH (Table 2.2.1, entries 13, 14).

**Table 2.2.1** Optimization of reaction conditions for the synthesis of 2-amino-3-methyl-3-phenyl- 5-(phenylthio)-3*H*-pyrrole-4-carbonitrile (2.2.1a)

Entry	Catalyst	Amounts (mol %)	Solvent	Temp, Time (°C) (h)	Isolated yield (%)
1	NaOH	10	H <sub>2</sub> O	100, 2	2 2
2	K <sub>2</sub> CO <sub>3</sub>	10	H <sub>2</sub> O	100, 2	4 7
3	-	-	H <sub>2</sub> O	100, 20	-
4	Guanidine	20	H <sub>2</sub> O	100, 3	8 6
5	DBU	20	H <sub>2</sub> O	100, 3	8 8
6	Piperidine	20	H <sub>2</sub> O	100, 3	8 9
7	Et <sub>3</sub> N	20	H <sub>2</sub> O	60, 10	6 2
8	Et <sub>3</sub> N	20	H <sub>2</sub> O	100, 3	9 4
9	Pyridine	20	H <sub>2</sub> O	100, 3	9 1
10	Et <sub>3</sub> N	20	Toluene	100-110, 3	8 4

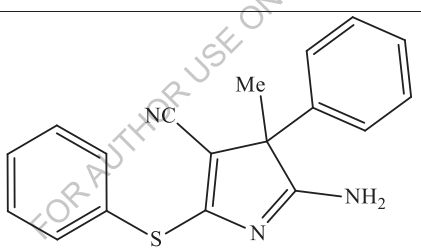
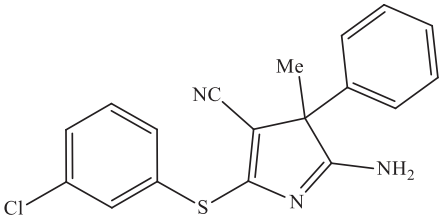
11	Et <sub>3</sub> N	20	DMS O	120-130, 3	7 4
12	Et <sub>3</sub> N	20	DMF	120-130, 3	7 9
13	Et <sub>3</sub> N	20	ACN	70-80, 3	6 4
14	Et <sub>3</sub> N	20	EtOH	70-80, 3	6 5
15	Et <sub>3</sub> N	20	MeOH	50-60, 3	4 1
16	Et <sub>3</sub> N	20	DCM	30-35, 3	2 1

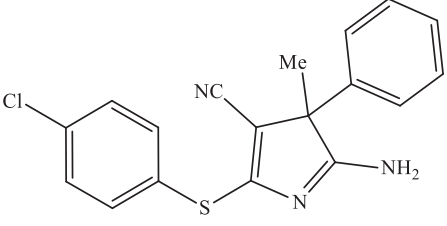
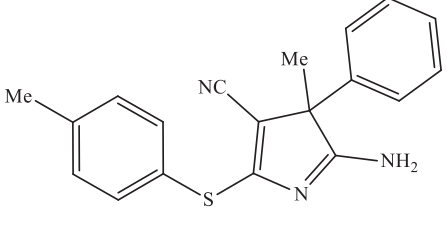
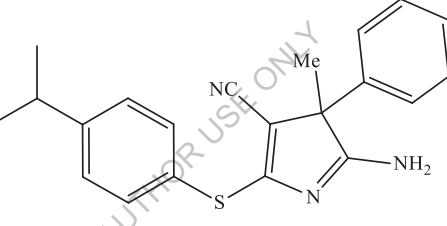
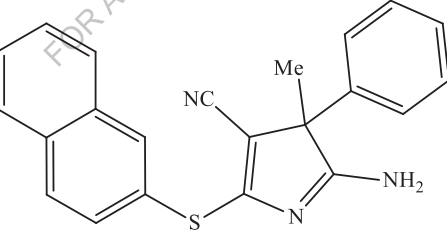
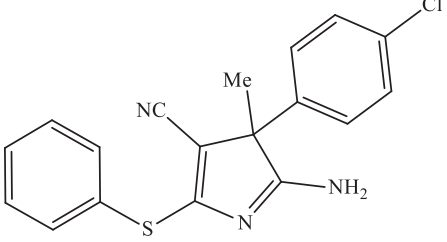
\*Reaction conditions: Acetophenone (1 mmol), malononitrile (2 mmol), thiophenol (2 mmol), different catalysts, different solvents, different temperature, different time.

After the standardization of the reaction conditions, a variety of ketones and thiols were used to prove the generality of the reaction (Table 2.2.2). Aromatic, alicyclic (Table 2.2.2, entry 12) as well as alkyl (Table 2.2.2, entry 13) thiols afforded the products in good to excellent yields. It was pleasing to find that sterically bulky naphthalene-2-thiol also reacted very efficiently with no side reactions (Table 2.2.2, entries 6 and 11). To further expand the scope of the reaction the use of different ketones were investigated. Despite the difficulty of a Knoevenagel condensation reaction with electron-rich ketones, the reaction occurred successfully with 3',4'-dimethoxy acetophenone (Table 2.2.2, entries 14-16). In addition, the use of aliphatic ketones (Table 2.2.2, entry 17) was also examined. The modularity of this pyrrole-forming reaction sequence was further

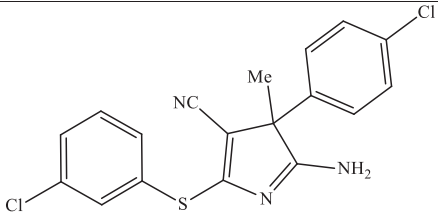
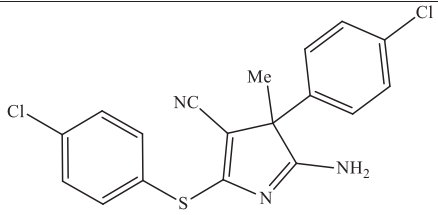
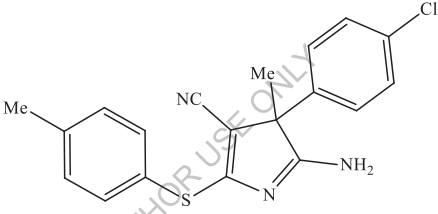
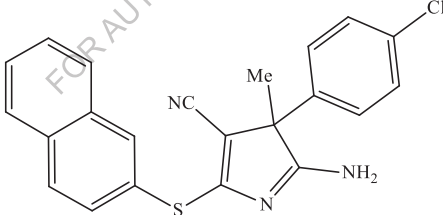
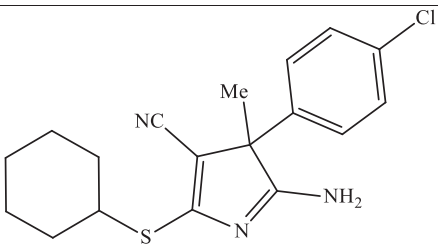
demonstrated by the use of heteroaryl ketones (Table 2.2.2, entries 19-22). It is important to mention that in addition to methyl ketones, other substituted alkyl ketones (e.g. ethyl phenyl ketone and 1,2-diphenylethanone) reacted smoothly under the present conditions (Table 2.2.2, entries 23-25). The low reactivity of substituted alkyl ketones in this reaction was also reflected in the reaction yield which might be due to the steric crowding among the substituents

**Table 2.2.2** Diversity of Uniquely Decorated 3*H*-Pyrroles\*

Entry	Product no.	Product	Yield (%) (isolated)
1	2.2.1a	 <p>Chemical structure of 2-amino-3-(4-phenylthio)pyrrole-4-methyl-5-nitrile. The pyrrole ring is substituted with a methyl group (Me) at the 4-position, an amino group (NH<sub>2</sub>) at the 2-position, a nitrile group (NC) at the 5-position, and a 4-phenylthio group (-S-C<sub>6</sub>H<sub>4</sub>) at the 3-position.</p>	94
2	2.2.1b	 <p>Chemical structure of 2-amino-3-(4-chlorophenylthio)pyrrole-4-methyl-5-nitrile. The pyrrole ring is substituted with a methyl group (Me) at the 4-position, an amino group (NH<sub>2</sub>) at the 2-position, a nitrile group (NC) at the 5-position, and a 4-chlorophenylthio group (-S-C<sub>6</sub>H<sub>4</sub>-Cl) at the 3-position.</p>	93

3	2.2.1c		93
4	2.2.1d		93
5	2.2.1e		93
6	2.2.1f		93
7	2.2.1g		93



8	2.2.1h		92
9	2.2.1i		91
10	2.2.1j		92
11	2.2.1k		92
12	2.2.1l		90

13	2.2.1m		86
14	2.2.1n		90
15	2.2.1o		91
16	2.2.1p		92
17	2.2.1q		91

18	2.2.1r		92
19	2.2.1s		92
20	2.2.1t		90
21	2.2.1u		93
22	2.2.1v		89

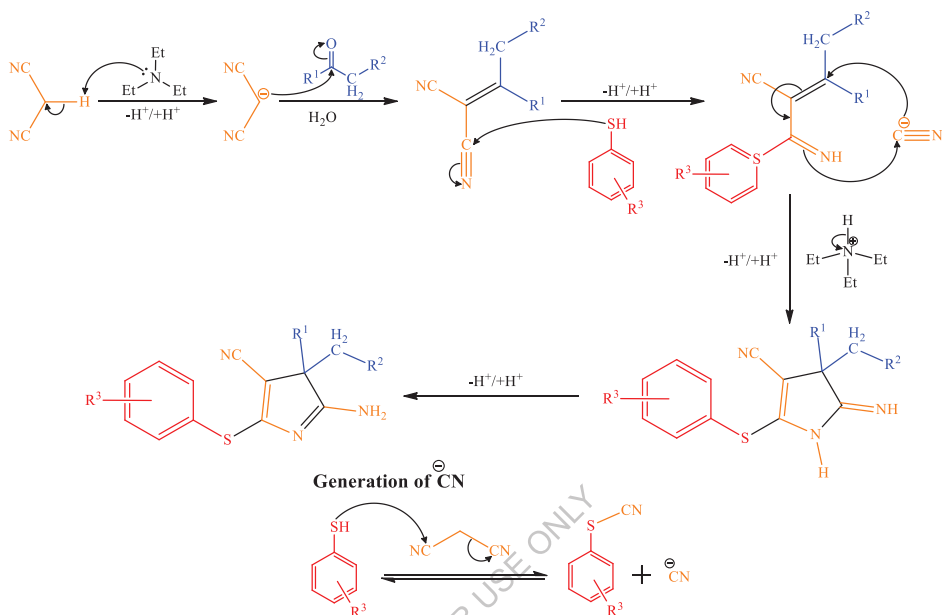
23	2.2.1w		84
24	2.2.1x		83
25	2.2.1y		81

Reaction condition: Ketones (1 mmol), malononitrile (2 mmol), thiols (2 mmol), Et<sub>3</sub>N (20 mol %), reflux in water at 100 °C or 3 h.

The probable mechanism of the 3*H*-pyrrole formation has been given in Scheme 2.2.3. Mechanistically, it is conceivable that the aromatic ketones first undergo a Knoevenagel condensation reaction with malononitrile which is a very characteristic reaction of carbonyl compounds in the presence of a base.<sup>24</sup> This was evident from NMR spectrum of the major product [A, (R<sup>1</sup> = 4'-Cl-C<sub>6</sub>H<sub>4</sub>- and R<sup>2</sup> = H)] isolated after 30 min. This intermediate A underwent nucleophilic attack by thiols on -CN functionality to give the in situ intermediate B. In

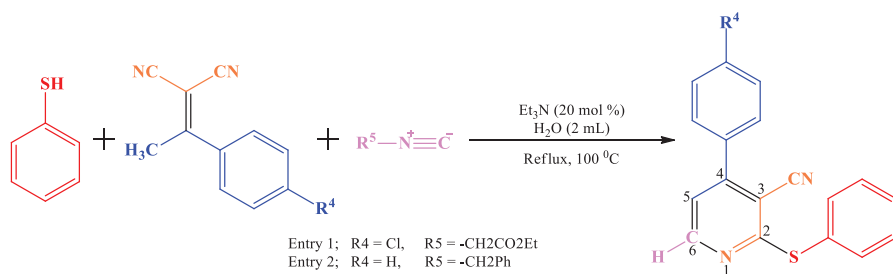
intermediate B the double bonds in *s-cis* fashion facilitate the cheletropic addition with cyanide ion to give an amidine species C that tautomerized to yield the 2-amino-3*H*-pyrrole. Highly reactive cyanide species was presumed to be formed by the nucleophilic attack of thiols on malononitrile by a mechanism drawn in Scheme 2.2.3. This proposition was further supported by the isolation of the by-product, 2-(phenylthio)acetonitrile (Compound D, Scheme 2.2.3) formed by the nucleophilic attack of PhSH on malononitrile which furnishes cyanide ions for the reaction. Thus, malononitrile acts as a non-toxic cyanide source in this reaction.

Here, despite Knoevenagel condensation being a net dehydration of the water molecule, the reaction is favored in aqueous medium. A plausible explanation is that water helps in better contact between the catalyst (Et<sub>3</sub>N) and the active methylene compounds through hydrogen-bonding.<sup>25</sup> Thus, realizing environmental concerns, as well as vast utility and scope of reactions carried out in water, water was preferred over other solvents.



**Scheme 2.2.3** Probable mechanism of 3*H*-pyrrole formation

After realizing the mechanism of 3*H*-pyrrole formation, it was of great curiosity to think about the possible results if Knoevenagel product of ketone and malononitrile (intermediate A) being allowed to react with thiophenol and isocyanide compounds under the same reaction conditions instead of using two equivalents of malononitrile. The corresponding 3*H*-pyrrole was not isolated. However, instead of anticipated 3*H*-pyrrole, an unexpected pyridine compound was generated according to Scheme 2.2.4 and Table 2.2.3.



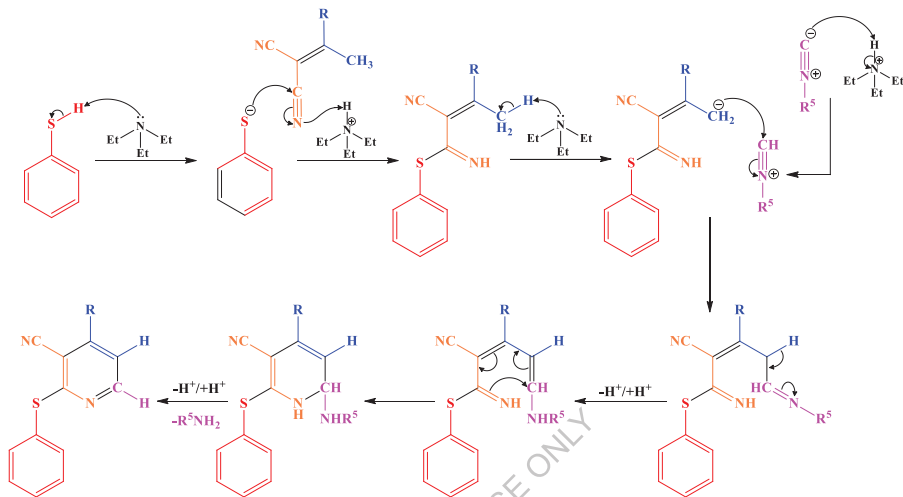
**Scheme 2.2.4**

Entry	Product no.	Product	Yield (%) (isolated)
1	2.2.4a		80
2	2.2.4b		70

\*Reaction condition: Knoevenagel product (1 mmol), thiophenol (1 mmol), isocyanide (1 mmol), Et<sub>3</sub>N (20 mol %), reflux in water at 100 °C for 3h.

It is worthy to mention that the mechanism of this reaction was a special case

which depicted the incorporation of only one carbon atom from isocyanide to pyridine (Scheme 2.2.5).



**Scheme 2.2.5** Probable mechanism of pyridine formation

## 2.2 Importance of the present methodology

- This was the first report of an innovative, one-pot, organocatalyzed, multicomponent synthesis of 3*H*-pyrroles from ketones, thiols and malononitrile in ecofriendly solvent water.
- The approach to 3*H*-pyrroles presented herein, offered for the first time, an unprecedented coupling which led to the construction of the nitrogen containing ring without starting from any amine moiety.
- This novel 3*H*-pyrrole synthesis described an entirely new approach involving the dual role of CN moiety (both as carbon centre nucleophile during the attack of CN<sup>-</sup> on intermediate B and also acting as an electrophile during the cheletropic ring closure), an area that remained elusive in current organic research.
- This newly developed protocol is a significant proof of the fact that nitrile is



one of the most versatile functional groups as it can be readily transformed into various other functional groups or reactive intermediates.

(e) Here, malononitrile was acting as a nontoxic cyanide source.

(f) In the course of the reaction, three new bonds (C-C, C-S and C-N bonds) were formed in a single operation.

(g) The same methodology could be efficiently utilized for the construction of pyridines.

(h) The formation of pyridine products occurred via an unusual mechanism which depicted the incorporation of only one carbon atom from isocyanide to pyridine.

## 2.3 Conclusion

In summary, a novel multicomponent synthesis of 3*H*-pyrroles and pyridine derivatives by one-pot, organocatalyzed and multicomponent fashion in ecofriendly solvent water has been developed in good to excellent yields. Furthermore, the presence of a cyano group in the pyrroles and pyridines have made them useful synthetic intermediates for the preparation of other nitrogen-containing heterocycles.

## 2.4 Experimental

### 2.4.1 Materials and instruments

**General:** All solvents were dried by standard methods. Chemicals were purchased from Sigma- Aldrich and Spectrochem (India) and used without further purification. Column chromatography was performed on silica gel (60-120 mesh). TLC was done on glass sheets pre-coated with silica gel (with binder, 300 mesh, Spectrochem). The <sup>1</sup>H-NMR spectra were taken mostly in DMSO-*d*<sub>6</sub> and few in CDCl<sub>3</sub> with TMS (Me<sub>4</sub>Si) as an internal reference on Bruker 300 MHz instrument at 300 MHz. <sup>13</sup>C-NMR spectra were taken in CDCl<sub>3</sub> at 75 MHz. The chemical

shifts were reported as  $\delta$  values (ppm) relative to TMS. IR spectra were recorded in KBr pellets on a Perkin Elmer Spectrophotometer RX / FT- IR system. EI mass spectra were performed on Q-TOF-Micromass (location: Indian Institute of Chemical Biology, 4, Raja S. C. Mullick Road, Kolkata-700032). The C-H-N-analyses were carried out on a 2400 Series II CHNS Analyzer, Perkin Elmer USA at Indian Association for the Cultivation of Science, Jadavpur, Kolkata 700 032, India.

## **2.4.2 General experimental procedures for the synthesis of 3*H*-pyrroles and pyridines**

### **2.4.2.1 General experimental procedure for the synthesis of 3*H*-pyrroles**

A mixture of ketone (1 mmol), malononitrile (2 mmol), thiol (2 mmol), 20 mol % Et<sub>3</sub>N catalyst and water (2 mL) were taken in a 25 mL round-bottomed flask fitted with a reflux condenser. The resulting mixture was refluxed at 100 °C for 3 hours in an oil bath. The completion of the reaction was indicated by the disappearance of the starting materials in thin layer chromatography. After completion of the reaction, the reaction mixture was cooled to room temperature (25-30 °C) and the crude product was extracted from water in DCM (2x10 mL) using separating funnel. The solvents were evaporated in a rotary evaporator and the residue was subjected to silica gel column chromatography (60-120 mesh) with 30% ethyl acetate in petroleum ether (60-80 °C) as eluant.

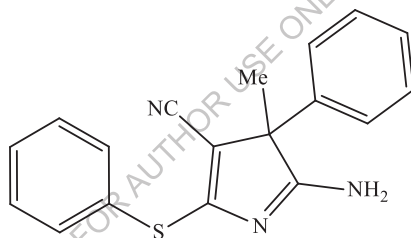
### **2.4.2.2 General experimental procedure for the synthesis of pyridines**

A mixture of Knoevenagel product (1 mmol) of ketone and malononitrile, thiol (1 mmol), isocyanide (1 mmol), 20 mol % Et<sub>3</sub>N catalyst and water (2 mL) were taken in a 25 mL round-bottomed flask fitted with a reflux condenser. The resulting

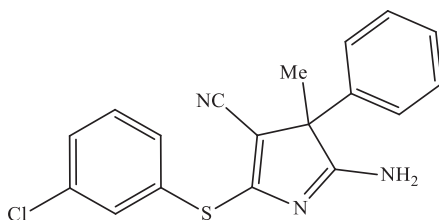
mixture was then refluxed at 100 °C for 3 hours in an oil bath. The completion of the reaction was indicated by the disappearance of the starting materials in thin layer chromatography. After completion of the reaction, the reaction mixture was cooled to room temperature (25-30 °C) and the crude product was extracted from water in DCM (2x10 mL) using separating funnel. The solvents were evaporated in a rotary evaporator and the residue was subjected to silica gel column chromatography (60-120 mesh) with 15% ethyl acetate in petroleum ether (60-80 °C) as eluant.

## 2.1.1 Characteristic data of the synthesized compounds

### 2.1.1.1 Characteristic data of the 3*H*-pyrroles

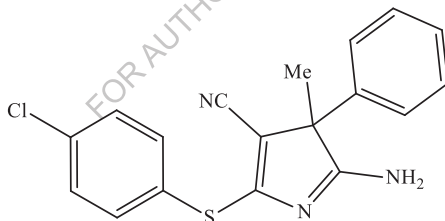


**2-Amino-3-methyl-3-phenyl-5-(phenylthio)-3*H*-pyrrole-4-carbonitrile** (2.2.1a, Table 2.2.2, entry 1): Yield (387 mg, 94%); Brown colored solid; mp 161–163 °C (EtOAc/ DCM); IR (KBr) 3490, 3444, 3346, 3292, 3102, 2209, 1618, 1567, 1541, 1440, 1164, 698 cm<sup>-1</sup>; <sup>1</sup>H NMR (300 MHz, DMSO-d<sub>6</sub>; Me<sub>4</sub>Si) δ 1.52 (3H, s), 7.07-7.11 (m, 3H), 7.13-7.19 (m, 2H), 7.27-7.41 (m, 5H), 7.77 (s, NH, 1H), 8.36 (s, NH, 1H); <sup>13</sup>C NMR (75 MHz, CDCl<sub>3</sub>; Me<sub>4</sub>Si) δ 21.1, 60.5, 97.8, 115.5, 125.0, 127.0, 128.1, 129.3, 129.5, 129.6, 129.7, 130.3, 134.0, 136.1, 136.9, 137.0, 166.8, 182.6; Anal. Calcd for C<sub>18</sub>H<sub>15</sub>N<sub>3</sub>S: C, 70.79; H, 4.95; N, 13.76%. Found: C, 70.83; H, 4.97; N, 13.79%. EI MS (*m/z*): Calcd. 306.11, found 305.99 for [M+H]<sup>+</sup> and Calcd. 328.09, found 327.97 for [M+Na]<sup>+</sup>.



**2-Amino-5-(3-chlorophenylthio)-3-methyl-3-phenyl-3H-pyrrole-4-**

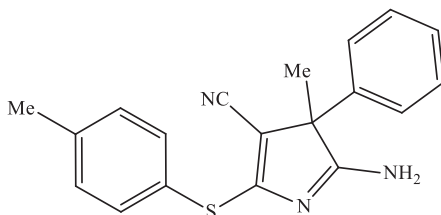
**carbonitrile** (2.2.1b, Table 2.2.2, entry 2): Yield (316 mg, 93%); Light brown colored solid; mp 163–165 °C (EtOAc/DCM); IR (KBr) 3470, 3434, 3349, 3252, 3100, 2211, 1616, 1568, 1540, 1164, 704  $\text{cm}^{-1}$ ;  $^1\text{H}$ NMR (300 MHz, DMSO- $d_6$ ; Me $_4$ Si)  $\delta$  1.66 (s, 3H), 7.20 (d,  $J=7.2$  Hz, 2H), 7.32–7.50 (m, 5H), 7.54–7.57 (m, 1H), 7.67 (s, 1H), 7.88 (s, 1H, NH), 8.45 (s, 1H, NH);  $^{13}\text{C}$  NMR (75 MHz, CDCl $_3$ ; Me $_4$ Si)  $\delta$  21.8, 60.8, 100.0, 114.8, 125.8, 128.5, 129.3, 129.5, 130.2, 131.1, 132.6, 134.1, 134.7, 136.6, 164.7, 182.4; Anal. Calcd for C $_{18}$ H $_{14}$ ClN $_3$ S: C, 63.62; H, 4.15; N, 12.36%. Found: C, 63.61; H, 4.14; N, 12.36%.



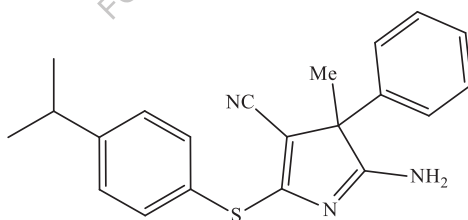
**2-Amino-5-(4-chlorophenylthio)-3-methyl-3-phenyl-3H-pyrrole-4-carbonitrile**

(2.2.1c, Table 2.2.2, entry 3): Yield (316 mg, 93%); Light brown colored solid; mp 164–166 °C (EtOAc/DCM); IR (KBr) 3445, 3333, 3290, 3092, 2212, 1617, 1567, 1546, 1440, 1168, 698  $\text{cm}^{-1}$ ;  $^1\text{H}$ NMR (300 MHz, DMSO- $d_6$ ; Me $_4$ Si)  $\delta$  1.66 (s, 3H), 7.25 (d,  $J=7.5$  Hz, 2H), 7.38 (d,  $J=9.0$  Hz, 2H), 7.42–7.56 (m, 5H), 7.87 (s, 1H, NH), 8.45 (s, 1H, NH);  $^{13}\text{C}$  NMR (75 MHz, CDCl $_3$ ; Me $_4$ Si)  $\delta$  21.4, 60.7, 99.4, 114.8, 125.5, 125.6, 127.4, 128.3, 129.2, 135.5, 135.6, 135.67, 135.7, 135.8,

136.5, 165.4, 182.1; Anal. Calcd for  $C_{18}H_{14}ClN_3S$ : C, 63.62; H, 4.15; N, 12.36%. Found: C, 63.66; H, 4.15; N, 12.35%.

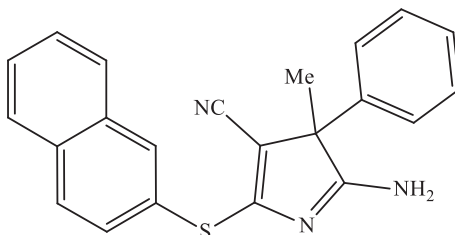


**2-Amino-3-methyl-3-phenyl-5-(p-tolylthio)-3H-pyrrole-4-carbonitrile** (2.2.1d, Table 2.2.2, entry 4): Yield (297 mg, 93%); Cream colored solid; mp 179–181 °C (EtOAc/ DCM); IR (KBr) 3454, 3442, 3336, 3292, 3100, 2200, 1618, 1566, 1541, 1445, 1164, 698  $cm^{-1}$ ;  $^1H$  NMR (300 MHz, DMSO- $d_6$ ; Me $_4$ Si)  $\delta$  1.63 (s, 3H), 2.32 (s, 3H), 7.17-7.24 (m, 4H), 7.29-7.34 (m, 1H), 7.37-7.47 (m, 4H), 7.78 (s, 1H, NH), 8.36 (s, 1H, NH);  $^{13}C$  NMR (75 MHz, CDCl $_3$ ; Me $_4$ Si)  $\delta$  21.0, 21.7, 60.5, 97.8, 115.3, 125.7, 125.8, 128.3, 129.3, 129.9, 135.2, 137.1, 139.7, 166.5, 182.3; Anal. Calcd for  $C_{19}H_{17}N_3S$ : C, 71.44; H, 5.36; N, 13.15%. Found: C, 71.45; H, 5.37; N, 13.14%.



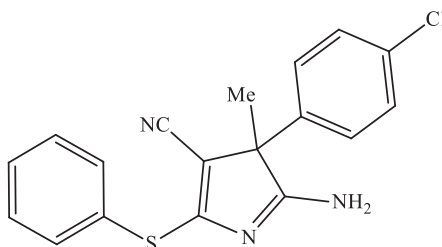
**2-Amino-5-(4-isopropylphenylthio)-3-methyl-3-phenyl-3H-pyrrole-4-carbonitrile** (2.2.1e, Table 2.2.2, entry 5): Yield (323 mg, 93%); Light brown colored solid; mp 190–192 °C (EtOAc/ DCM); IR (KBr) 3430, 3414, 3366, 3282, 3100, 2901, 2201, 1619, 1565, 1533, 1450, 1166, 704  $cm^{-1}$ ;  $^1H$  NMR (300 MHz, DMSO- $d_6$ ; Me $_4$ Si)  $\delta$  1.19 (s, 3H), 1.21 (s, 3H), 1.64 (s, 3H), 2.89-2.93 (m, 1H),

7.19 (d,  $J=7.2$  Hz, 2H), 7.28-7.34 (m, 3H), 7.33-7.43 (m, 2H), 7.47 (d,  $J=8.1$  Hz, 2H), 7.79 (s, 1H, NH), 8.37 (s, 1H, NH);  $^{13}\text{C}$  NMR (75 MHz,  $\text{CDCl}_3$ ;  $\text{Me}_4\text{Si}$ )  $\delta$  21.7, 23.6, 33.6, 60.7, 98.9, 115.2, 125.8, 127.3, 128.3, 129.3, 134.9, 137.1, 150.6, 166.5, 182.4; Anal. Calcd for  $\text{C}_{21}\text{H}_{21}\text{N}_3\text{S}$ : C, 72.59; H, 6.09; N, 12.09%. Found: C, 72.60; H, 6.10; N, 12.12%.



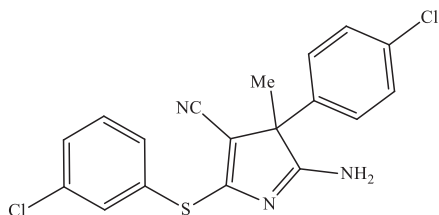
**2-Amino-3-methyl-5-(naphthalene-2-ylthio)-3-phenyl-3H-pyrrole-4-**

**carbonitrile** (2.2.1f, Table 2.2.2, entry 6): Yield (330 mg, 93%); Cream colored solid; mp 198–200 °C (EtOAc/DCM); IR (KBr) 3493, 3445, 3347, 3292, 2992, 2210, 1616, 1569, 1543, 1440, 1167, 698  $\text{cm}^{-1}$ ;  $^1\text{H}$  NMR (300 MHz,  $\text{DMSO}-d_6$ ;  $\text{Me}_4\text{Si}$ )  $\delta$  1.67 (s, 3H), 7.22 (d,  $J=7.2$  Hz, 2H), 7.33-7.44 (m, 3H), 7.57-7.65 (m, 3H), 7.82 (s, 1H, NH), 7.95-7.98 (m, 3H), 8.22 (s, 1H), 8.36 (s, 1H, NH);  $^{13}\text{C}$  NMR (75 MHz,  $\text{CDCl}_3$ ;  $\text{Me}_4\text{Si}$ )  $\delta$  21.3, 60.3, 98.2, 115.4, 125.6, 126.7, 127.3, 127.7, 128.2, 128.8, 129.2, 131.5, 132.7, 133.0, 134.3, 136.7, 166.2, 182.0; Anal. Calcd for  $\text{C}_{22}\text{H}_{17}\text{N}_3\text{S}$ : C, 74.34; H, 4.82; N, 11.82%. Found: C, 74.36; H, 4.81; N, 11.82%.



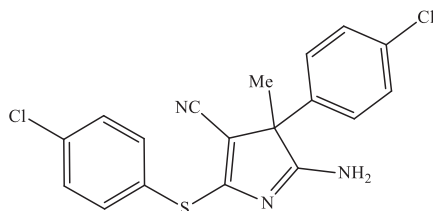
**2-Amino-3-(4-chlorophenyl)-3-methyl-5-(phenylthio)-3H-pyrrole-4-**

**carbonitrile** (2.2.1g, Table 2.2.2, entry 7): Yield (316 mg, 93%); Light brown colored solid; mp 158–160 °C (EtOAc/ DCM); IR (KBr) 3490, 3444, 3345, 3292, 3102, 2209, 1638, 1567, 1541, 1440, 1164, 705  $\text{cm}^{-1}$ ;  $^1\text{H}$  NMR (300 MHz, DMSO- $d_6$ ; Me $_4$ Si)  $\delta$  1.63 (s, 3H), 7.18 (d,  $J=8.4$  Hz, 2H), 7.40-7.48 (m, 5H), 7.56-7.59 (m, 2H), 7.85 (s, 1H, NH ), 8.43 (s, 1H, NH);  $^{13}\text{C}$  NMR (75 MHz, CDCl $_3$ ; Me $_4$ Si)  $\delta$  21.5, 60.1, 97.5, 115.2, 126.6, 127.4, 128.2, 128.3, 129.2, 129.3, 129.7, 129.9, 130.1, 130.6, 135.6, 136.3, 167.1, 182.1; Anal. Calcd for C $_{18}$ H $_{14}$ ClN $_3$ S: C, 63.62; H, 4.15; N, 12.36%. Found: C, 63.68; H, 4.16; N, 12.38%.

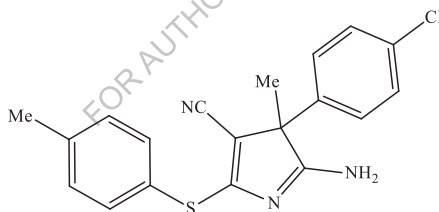


**2-Amino-3-(4-chlorophenyl)-5-(3-chlorophenylthio)-3-methyl-3H-pyrrole-4-**

**carbonitrile** (2.2.1h, Table 2.2.2, entry 8): Yield: (344 mg, 92%); Cream colored solid; mp 150–152 °C (EtOAc/ DCM); IR (KBr) 3490, 3444, 3346, 3292, 3102, 2209, 1618, 1567, 1531, 1450, 1164, 698  $\text{cm}^{-1}$ ;  $^1\text{H}$  NMR (300 MHz, DMSO- $d_6$ ; Me $_4$ Si)  $\delta$  1.64 (s, 3H), 7.20 (d,  $J=8.7$  Hz, 2H), 7.44-7.57 (m, 5H), 7.68 (s, 1H), 7.92 (s, 1H, NH), 8.49 (s, 1H, NH);  $^{13}\text{C}$  NMR (75 MHz, CDCl $_3$ ; Me $_4$ Si)  $\delta$  21.7, 60.3, 99.0, 114.7, 127.4, 129.4, 129.8, 130.3, 131.2, 132.6, 133.0, 134.1, 134.6, 134.8, 135.2, 165.5, 182.2; Anal. Calcd for C $_{18}$ H $_{13}$ Cl $_2$ N $_3$ S: C, 57.76; H, 3.50; N, 11.23%. Found: C, 57.78; H, 3.51; N, 11.25%.



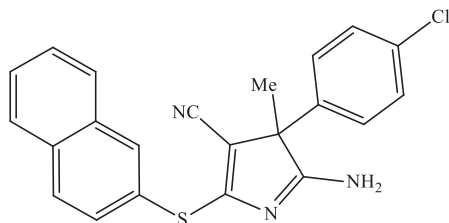
**2-Amino-3-(4-chlorophenyl)-5-(4-chlorophenylthio)-3-methyl-3H-pyrrole-4-carbonitrile** (2.2.1i, Table 2.2.2, entry 9): Yield (341 mg, 91%); White colored solid; mp 140–142 °C (EtOAc/ DCM); IR (KBr) 3430, 2400, 3356, 3091, 2201, 1634, 1549, 1423, 1386, 1146, 756  $\text{cm}^{-1}$ ;  $^1\text{H}$  NMR (300 MHz, DMSO- $d_6$ ; Me $_4$ Si)  $\delta$  1.63 (s, 3H), 7.17 (d,  $J=8.7$  Hz, 2H), 7.44-7.50 (m, 4H), 7.61 (d,  $J=7.8$  Hz, 2H), 7.89 (s, 1H, NH), 8.44 (s, 1H, NH);  $^{13}\text{C}$  NMR (75 MHz, CDCl $_3$ ; Me $_4$ Si)  $\delta$  21.5, 60.4, 99.1, 114.7, 127.2, 127.4, 129.48, 129.56, 129.63, 134.6, 135.3, 135.9, 136.1, 166.0, 181.9; Anal. Calcd for C $_{18}$ H $_{13}$ Cl $_2$ N $_3$ S: C, 57.76; H, 3.50; N, 11.23%. Found: C, 57.77; H, 3.51; N, 11.25%.



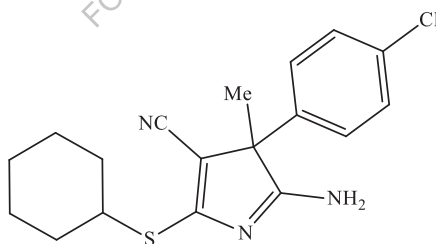
**2-Amino-3-(4-chlorophenyl)-3-methyl-5-(p-tolylthio)-3H-pyrrole-4-carbonitrile** (2.2.1, Table 2.2.2, entry 10): Yield (326 mg, 92%); Brown colored solid; mp 180–182 °C (EtOAc/ DCM); IR (KBr) 3400, 3346, 3081, 2881, 1712, 1634, 1549, 1498, 1423, 1386, 1146, 1091, 756  $\text{cm}^{-1}$ ;  $^1\text{H}$  NMR (300 MHz, DMSO- $d_6$ ; Me $_4$ Si)  $\delta$  1.62 (s, 3H), 2.32 (s, 3H), 7.17-7.24 (m, 4H), 7.45-7.48 (m, 4H), 7.82 (s, 1H, NH), 8.40 (s, 1H, NH);  $^{13}\text{C}$  NMR (75 MHz, CDCl $_3$ ; Me $_4$ Si)  $\delta$  21.1, 21.6, 60.1, 97.7, 115.0, 125.4, 127.3, 129.5, 129.6, 130.0, 134.5, 135.3, 135.7, 139.9, 167.0, 181.8; Anal. Calcd for C $_{19}$ H $_{16}$ ClN $_3$ S: C, 64.49; H, 4.44; N, 11.07%. Found: C, 64.49; H, 4.44; N, 11.07%.



4.56; N, 11.87%. Found: C, 64.53; H, 4.57; N, 11.86%.

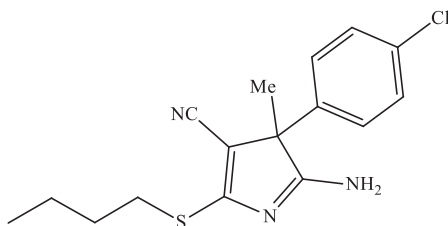


**2-Amino-3-(4-chlorophenyl)-3-methyl-5-(naphthalen-2-ylthio)-3H-pyrrole-4-carbonitrile** (2.2.1k, Table 2.2.2, entry 11): Yield (358 mg, 92%); White colored solid; mp 183–185 °C (EtOAc/ DCM); IR (KBr) 3450, 3444, 3336, 3292, 3099, 2199, 1619, 1566, 1541, 1470, 1164, 679  $\text{cm}^{-1}$ ;  $^1\text{H}$  NMR (300 MHz, DMSO- $d_6$ ; Me $_4$ Si)  $\delta$  1.65 (s, 3H), 7.22 (d,  $J=8.4$  Hz, 2H), 7.48 (d,  $J=8.4$  Hz, 2H), 7.57-7.65 (m, 3H), 7.86 (s, 1H, NH), 7.95-7.98 (m, 3H), 8.22 (s, 1H), 7.40 (s, 1H, NH);  $^{13}\text{C}$  NMR (75 MHz, CDCl $_3$ ; Me $_4$ Si)  $\delta$  21.4, 59.7, 97.5, 115.2, 126.6, 127.0, 127.4, 127.7, 127.8, 128.8, 129.3, 131.6, 132.6, 132.9, 134.2, 134.5, 135.3, 166.8, 181.8; Anal. Calcd for C $_{22}$ H $_{16}$ ClN $_3$ S: C, 67.77; H, 4.14; N, 10.78%. Found: C, 67.79; H, 4.15; N, 10.79%.

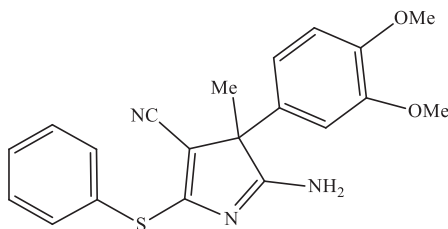


**2-Amino-3-(4-chlorophenyl)-5-(cyclohexylthio)-3-methyl-3H-pyrrole-4-carbonitrile** (2.2.1l, Table 2.2.2, entry 12): Yield (311 mg, 90%); White colored solid; mp 148–150 °C (EtOAc/ DCM); IR (KBr) 3455, 3399, 3346, 3289, 3100, 2202, 1627, 1567, 1548, 1440, 1164, 678  $\text{cm}^{-1}$ ;  $^1\text{H}$  NMR (300 MHz, DMSO- $d_6$ ; Me $_4$ Si)  $\delta$  1.27-1.61 (m, 8H), 1.73 (s, 3H), 2.01-2.04 (m, 2H), 3.81-3.86 (m, 1H),

6.54 (d,  $J=8.1$  Hz, 2H), 7.12 (d,  $J=8.4$  Hz, 2H), 7.42 (s, 1H, NH), 8.30 (s, 1H, NH);  $^{13}\text{C}$  NMR (75 MHz,  $\text{CDCl}_3$ ;  $\text{Me}_4\text{Si}$ )  $\delta$  21.0, 25.9, 30.0, 33.2, 43.0, 59.9, 98.2, 114.1, 128.8, 128.9, 129.5, 131.5, 136.9, 161.0, 181.0; Anal. Calcd for  $\text{C}_{18}\text{H}_{20}\text{ClN}_3\text{S}$ : C, 62.50; H, 5.83; N, 12.15%. Found: C, 62.55; H, 5.85; N, 12.17%.

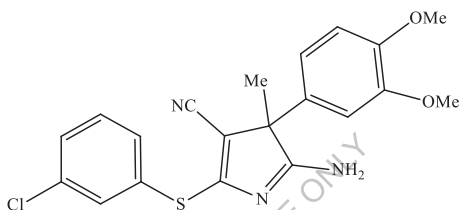


**2-Amino-5-butylsulfanyl-3-(4-chlorophenyl)-3-methyl-3H-pyrrole-4-carbonitrile** (2.2.1m, Table 2.2.2, entry 13): Yield (275 mg, 86%); White colored solid; mp 153–155 °C (EtOAc/DCM); IR (KBr) 3457, 3439, 3347, 3267, 3100, 2901, 2216, 1614, 1560, 1545, 1444, 1164, 710  $\text{cm}^{-1}$ ;  $^1\text{H}$  NMR (300 MHz,  $\text{DMSO-d}_6$ ;  $\text{Me}_4\text{Si}$ )  $\delta$  0.86 (t,  $J=7.2$  Hz, 3H), 1.32-1.34 (m, 2H), 1.60 (s, 3H), 1.66-1.71 (m, 2H), 2.94 (t,  $J=7.2$  Hz, 2H), 6.64 (d,  $J=8.1$  Hz, 2H), 7.21 (d,  $J=8.4$  Hz, 2H), 7.52 (s, 1H, NH), 8.40 (s, 1H, NH);  $^{13}\text{C}$  NMR (75 MHz,  $\text{DMSO-d}_6$ ;  $\text{Me}_4\text{Si}$ )  $\delta$  13.7, 20.2, 21.1, 29.0, 33.1, 60.0, 99.1, 115.0, 129.8, 129.9, 130.6, 132.5, 137.7, 160.0, 180.0; Anal. Calcd for  $\text{C}_{16}\text{H}_{18}\text{ClN}_3\text{S}$ : C, 60.08; H, 5.67; N, 13.14%. Found: C, 60.09; H, 5.68; N, 13.16%.

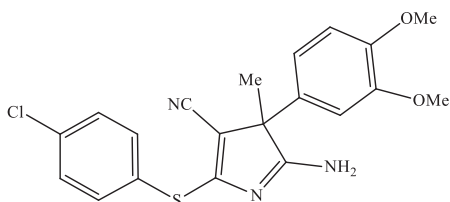


**2-Amino-3-(3,4-dimethoxyphenyl)-3-methyl-5-(phenylthio)-3H-pyrrole-4-carbonitrile** (2.2.1n, Table 2.2.2, entry 14): Yield (329 mg, 90%); Cream colored

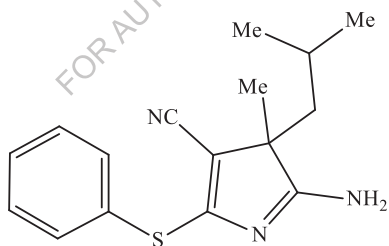
solid; mp 178–180 °C; IR (KBr) 3479, 3435, 3348, 3290, 3100, 2209, 1638, 1569, 1545, 1444, 1154, 698  $\text{cm}^{-1}$  (EtOAc/DCM);  $^1\text{H}$  NMR (300 MHz, DMSO- $d_6$ ; Me $_4$ Si)  $\delta$  1.60 (s, 3H), 3.60 (s, 3H), 3.83 (s, 3H), 6.76–6.79 (m, 1H), 7.03–7.15 (m, 1H), 7.19–7.20 (m, 1H), 7.24 (br s, 2H), 7.52–7.54 (m, 3H), 7.90 (s, 1H, NH), 8.44 (s, 1H, NH);  $^{13}\text{C}$  NMR (75 MHz, CDCl $_3$ ; Me $_4$ Si)  $\delta$  30.5, 55.9, 56.0, 60.0, 86.8, 110.4, 111.9, 115.1, 122.5, 127.6, 129.2, 129.8, 136.2, 148.8, 157.5, 182.2; Anal. Calcd for C $_{20}$ H $_{19}$ N $_3$ O $_2$ S: C, 65.73; H, 5.24; N, 11.50%. Found: C, 65.77; H, 5.24; N, 11.53%.



**2-Amino-5-(3-chlorophenylthio)-3-(3,4-dimethoxyphenyl)-3-methyl-3H-pyrrole-4 carbonitrile** (2.2.1o, Table 2.2.2, entry 15): Yield (364 mg, 91%); Cream colored solid; mp 179–181°C (EtOAc/ DCM); IR (KBr) 3490, 3444, 3346, 3292, 3102, 2209, 1618, 1567, 1541, 1440, 1164, 698  $\text{cm}^{-1}$ ;  $^1\text{H}$  NMR (300 MHz, DMSO- $d_6$ ; Me $_4$ Si)  $\delta$  1.61 (s, 3H), 3.70 (s, 3H), 3.85 (s, 3H), 6.90 (d,  $J=8.4$  Hz, 1H), 7.19 (d,  $J=2.1$  Hz, 1H), 7.37–7.53 (m, 3H), 7.62 (dd,  $J=8.3$  Hz,  $J=2.1$  Hz, 1H), 7.67 (s, 1H), 7.90 (s, 1H, NH), 8.47 (s, 1H, NH);  $^{13}\text{C}$  NMR (75 MHz, CDCl $_3$ ; Me $_4$ Si)  $\delta$  20.2, 55.8, 56.0, 58.8, 86.9, 110.5, 111.7, 115.8, 122.5, 128.4, 129.4, 129.9, 130.2, 134.1, 134.7, 135.8, 148.9, 165.4, 181.4; Anal. Calcd for C $_{20}$ H $_{18}$ ClN $_3$ O $_2$ S: C, 60.07; H, 4.54; N, 10.51%. Found: C, 60.09; H, 4.55; N, 10.54%.

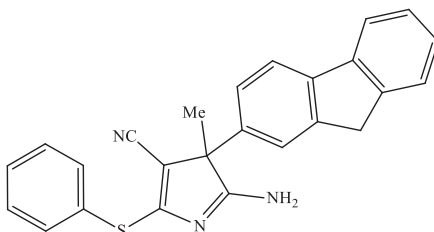


**2-Amino-5-(4-chlorophenylthio)-3-(3,4-dimethoxyphenyl)-3-methyl-3H-pyrrole-4-carbonitrile** (2.2.1p, Table 2.2.2, entry 16): Yield (368 mg, 92%); Cream colored solid; mp 182–184 °C (EtOAc/ DCM); IR (KBr) 3490, 3434, 3326, 3292, 3092, 2209, 1618, 1566, 1541, 1441, 1164  $\text{cm}^{-1}$ ;  $^1\text{H}$  NMR (300 MHz, DMSO- $d_6$ ;  $\text{Me}_4\text{Si}$ )  $\delta$  1.60 (s, 3H), 3.64 (s, 3H), 3.85 (s, 3H), 6.90 (d,  $J=8.7$  Hz, 1H), 7.13 (s, 1H), 7.44 (d,  $J=8.4$  Hz, 2H), 7.56 (d,  $J=8.4$  Hz, 2H), 7.63- 7.76 (m, 1H), 7.93 (s, 1H, NH), 8.52 (s, 1H, NH);  $^{13}\text{C}$  NMR (75 MHz,  $\text{CDCl}_3$ ;  $\text{Me}_4\text{Si}$ )  $\delta$  21.2, 55.8, 56.0, 58.8, 88.9, 110.1, 111.3, 115.9, 122.5, 128.5, 129.3, 130.0, 130.1, 134.1, 135.9, 148.8, 166.0, 181.5; Anal. Calcd for  $\text{C}_{20}\text{H}_{18}\text{ClN}_3\text{O}_2\text{S}$ : C, 60.07; H, 4.54; N, 10.51%. Found: C, 60.09; H, 4.55; N, 10.54%.

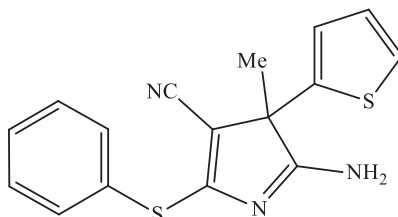


**2-Amino-3-isobutyl-3-methyl-5-(phenylthio)-3H-pyrrole-4-carbonitrile** (2.2.1q, Table 2.2.2, entry 17): Yield (260 mg, 91%); Cream colored solid; mp 148–150 °C (EtOAc/ DCM); IR (KBr) 3490, 3445, 3346, 3292, 3102, 2904, 2211, 1619, 1567, 1547, 1444, 1164, 658  $\text{cm}^{-1}$ ;  $^1\text{H}$  NMR (300 MHz, DMSO- $d_6$ ;  $\text{Me}_4\text{Si}$ )  $\delta$  0.84-0.90 (m, 3H), 0.91-0.92 (m, 3H), 1.10 (s, 3H), 1.51-1.52 (m, 2H), 1.77-1.86 (m, 1H), 6.85 (dd,  $J=6.6$  Hz,  $J=3.0$  Hz, 2H), 7.34-7.37 (m, 3H), 7.57 (s, 1H,

NH ), 8.40 (s, 1H, NH);  $^{13}\text{C}$  NMR (75 MHz,  $\text{CDCl}_3$ ;  $\text{Me}_4\text{Si}$ )  $\delta$  21.2, 23.5, 25.7, 49.0, 57.2, 97.5, 114.2, 126.6, 127.7, 127.8, 129.3, 135.3, 165.1, 181.8; Anal. Calcd  $\text{C}_{16}\text{H}_{19}\text{N}_3\text{S}$ : C, 67.33; H, 6.71; N, 14.72%. Found: C, 67.37; H, 6.73; N, 14.75%.

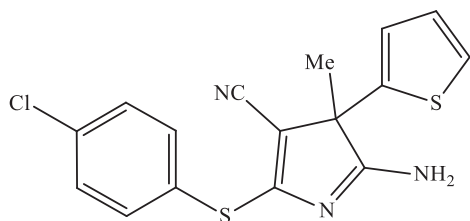


**2-Amino-3-(9H-fluoren-2-yl)-3-methyl-5-(phenylthio)-3H-pyrrole-4-carbonitrile** (2.2.1r, Table 2.2.2, entry 18): Yield (362 mg, 92%); Cream colored solid; mp 179–181 °C (EtOAc/ DCM); IR (KBr) 3410, 3404, 3333, 3242, 3100, 2201, 1625, 1569, 1540, 1440, 1154, 690  $\text{cm}^{-1}$ ;  $^1\text{H}$  NMR (300 MHz,  $\text{DMSO-d}_6$ ;  $\text{Me}_4\text{Si}$ )  $\delta$  1.61 (s, 3H), 3.80 (s, 2H), 6.73–6.76 (m, 2H), 7.21–7.23 (m, 3H), 7.25–7.42 (m, 2H), 7.54–7.57 (m, 1H), 7.71 (s, 1H, NH ), 7.77–7.82 (m, 2H), 7.97 (d,  $J=7.8$  Hz, 1H), 8.10 (s, 1H), 8.30 (s, 1H, NH);  $^{13}\text{C}$  NMR (75 MHz,  $\text{CDCl}_3$ ;  $\text{Me}_4\text{Si}$ )  $\delta$  21.3, 37.1, 60.3, 99.5, 116.2, 120.1, 121.8, 123.9, 125.0, 125.1, 125.2, 126.9, 126.92, 127.8, 127.3, 128.7, 129.9, 132.0, 134.8, 136.9, 150.4, 165.9, 182.0; Anal. Calcd for  $\text{C}_{25}\text{H}_{19}\text{N}_3\text{S}$ : C, 76.31; H, 4.87; N, 10.68%. Found: C, 76.35; H, 4.88; N, 10.69%.



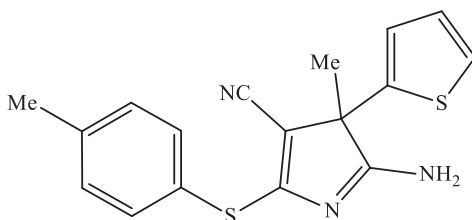
**2-Amino-3-methyl-5-(phenylthio)-3-(thiophen-2-yl)-3H-pyrrole-4-carbonitrile**

(2.2.1s, Table 2.2.2, entry 19): Yield (287 mg, 92%); Brown colored solid; mp 166–168 °C (EtOAc/ DCM); IR (KBr) 3418, 3317, 3099, 2966, 2921, 2728, 2201, 1661, 1548, 1520, 1440, 1198, 755, 692, 517 $\text{cm}^{-1}$ ;  $^1\text{H}$  NMR (300 MHz, DMSO- $d_6$ ; Me $_4\text{Si}$ )  $\delta$  1.74 (s, 3H), 7.09-7.12 (m, 2H), 7.47-7.48 (m, 3H), 7.54-7.55 (m, 1H), 7.61-7.62 (m, 2H), 8.01 (s, 1H, NH), 8.54 (s, 1H, NH);  $^{13}\text{C}$  NMR (75 MHz, CDCl $_3$ ; Me $_4\text{Si}$ )  $\delta$  24.0, 58.0, 97.0, 115.2, 124.9, 126.0, 127.6, 129.3, 129.3, 135.1, 141.1, 167.4, 181.0; Anal. Calcd for C $_{16}\text{H}_{13}\text{N}_3\text{S}_2$ : C, 61.71; H, 4.21; N, 13.49%. Found: C, 61.81; H, 4.23; N, 13.50%.



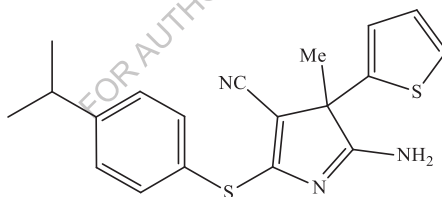
**2-Amino-5-(4-chlorophenylthio)-3-methyl-3-(thiophen-2-yl)-3H-pyrrole-4-**

**carbonitrile** (2.2.1t, Table 2.2.2, entry 20): Yield (311 mg, 90%); Light brown crystalline solid; mp 188–190 °C (EtOAc/ DCM); IR (KBr) 3423, 3319, 3102, 2969, 2925, 2728, 2211, 1663, 1548, 1521, 1440, 1198, 755, 517  $\text{cm}^{-1}$ ;  $^1\text{H}$  NMR (300 MHz, DMSO- $d_6$ ; Me $_4\text{Si}$ )  $\delta$  1.71 (s, 3H), 6.79-6.82 (m, 1H), 6.86-6.90 (m, 2H), 7.13-7.20 (m, 2H), 7.53-7.58 (m, 1H), 7.66-7.68 (m, 1H), 7.81 (s, 1H, NH), 8.32 (s, 1H, NH);  $^{13}\text{C}$  NMR (75 MHz, CDCl $_3$ ; Me $_4\text{Si}$ )  $\delta$  21.4, 60.7, 99.4, 114.7, 125.5, 127.4, 128.3, 129.4, 135.6, 136.5, 140.1, 140.8, 148.9, 165.4, 182.0; Anal. Calcd for C $_{16}\text{H}_{12}\text{ClN}_3\text{S}_2$ : C, 55.56; H, 3.50; N, 12.15%. Found: C, 55.59; H, 3.53; N, 12.17%.



**2-Amino-3-methyl-3-(thiophen-2-yl)-5-(p-tolylthio)-3H-pyrrole-4-carbonitrile**

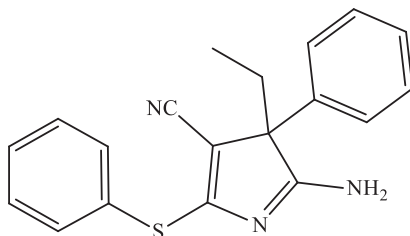
(2.2.1u, Table 2.2.2, entry 21): Yield (303 mg, 93%); Brown colored solid; mp 188–190 °C (EtOAc/ DCM); IR (KBr) 3400, 3321, 3097, 2968, 2921, 2209, 1645, 1548, 1525, 1440, 1199, 755, 699  $\text{cm}^{-1}$ ;  $^1\text{H}$ NMR (300 MHz, DMSO- $d_6$ ; Me $_4$ Si)  $\delta$  1.56 (s, 3H), 2.12 (s, 3H), 6.79 (br s, 2H), 6.91 (br s, 1H), 7.06 (d,  $J=7.2$  Hz, 1H), 7.17-7.21 (m, 1H), 7.32 (d,  $J=6.3$  Hz, 2H), 7.81 (s, 1H, NH), 8.32 (s, 1H, NH);  $^{13}\text{C}$  NMR (75 MHz, CDCl $_3$ ; Me $_4$ Si)  $\delta$  21.3, 24.0, 57.9, 97.0, 114.9, 125.0, 125.0, 126.1, 127.6, 130.2, 135.2, 140.1, 140.8, 166.4, 180.3; Anal. Calcd for C $_{17}$ H $_{15}$ N $_3$ S $_2$ : C, 62.74; H, 4.65; N, 12.91%. Found: C, 62.83; H, 4.66; N, 12.93%.



**2-Amino-5-(4-isopropylphenylthio)-3-methyl-3-(thiophen-2-yl)-3H-pyrrole-4-carbonitrile**

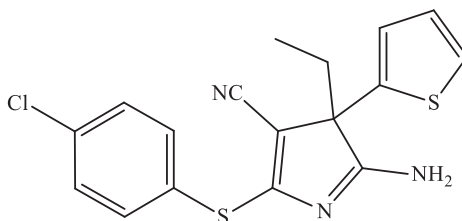
(2.2.1v, Table 2.2.2, entry 22): Yield (315 mg, 89%); Brown colored solid; mp 189–191 °C (EtOAc/ DCM); IR (KBr) 3404, 3300, 3112, 2956, 2911, 2718, 2212, 1647, 1549, 1523, 1440, 1198, 692, 519  $\text{cm}^{-1}$ ;  $^1\text{H}$  NMR (300 MHz, DMSO- $d_6$ ; Me $_4$ Si)  $\delta$  1.31 (s, 3H), 1.35 (s, 3H), 1.80 (s, 3H), 2.95-3.04 (m, 1H), 7.31 (d,  $J=5.1$  Hz, 2H), 7.38-7.46 (m, 2H), 7.73 (d,  $J=7.2$  Hz, 2H), 7.92 (s, 1H, NH), 8.07 (d,  $J=6.0$  Hz, 1H), 8.48 (s, 1H, NH);  $^{13}\text{C}$  NMR (75 MHz, CDCl $_3$ ; Me $_4$ Si)  $\delta$  21.7, 23.8,

34.0, 60.7, 99.8, 115.7, 124.3, 127.1, 127.7, 135.5, 136.5, 148.6, 165.8, 181.8; Anal. Calcd for C<sub>19</sub>H<sub>19</sub>N<sub>3</sub>S<sub>2</sub>: C, 64.55; H, 5.42; N, 11.89%. Found: C, 64.57; H, 5.45; N, 11.92%.



**2-Amino-3-ethyl-3-phenyl-5-(phenylthio)-3H-pyrrole-4-carbonitrile** (2.2.1w, Table 2.2.2,

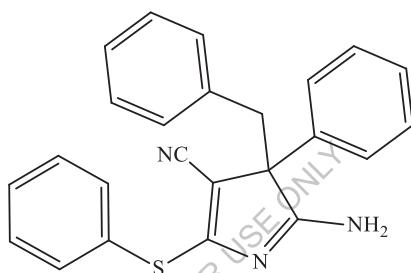
entry 23): Yield (268 mg, 84%); Light brown colored solid; mp 180–182 °C (EtOAc/DCM); IR (KBr) 3490, 3444, 3346, 3292, 3102, 2209, 1618, 1567, 1541, 1440, 1164, 698, 510 cm<sup>-1</sup>; <sup>1</sup>H NMR (300 MHz, DMSO-d<sub>6</sub>; Me<sub>4</sub>Si) δ 0.83-0.88 (m, 3H), 1.78-1.85 (m, 1H), 2.45-2.32 (m, 1H), 7.15-7.28 (m, 5H), 7.37-7.50 (m, 5H), 7.80 (s, 1H, NH), 8.34 (s, 1H, NH); <sup>13</sup>C NMR (75 MHz, DMSO-d<sub>6</sub>; Me<sub>4</sub>Si) δ 8.7, 28.5, 66.4, 96.7, 116.0, 126.8, 129.0, 129.7, 129.8, 130.0, 130.4, 135.5, 137.9, 167.9, 181.5; Anal. Calcd for C<sub>19</sub>H<sub>17</sub>N<sub>3</sub>S: C, 71.44; H, 5.36; N, 13.15%. Found: C, 71.46; H, 5.37; N, 13.16%.



**2-Amino-5-(4-chloro-phenylthio)-3-ethyl-3-phenyl-3H-pyrrole-4-carbonitrile**

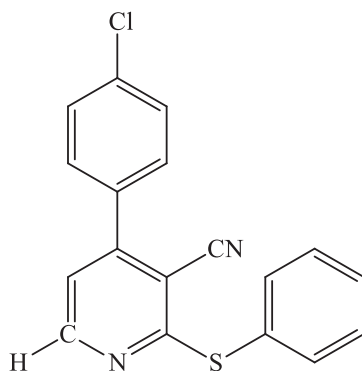


(2.2.1x, Table 2.2.2, entry 24): Yield (293 mg, 83%); Brown colored solid; mp 183–185 °C (EtOAc/ DCM); IR (KBr) 3430, 3414, 3366, 3282, 3100, 2901, 2201, 1619, 1565, 1533, 1450, 1166, 704  $\text{cm}^{-1}$ ;  $^1\text{H}$  NMR (300 MHz, DMSO- $d_6$ ; Me $_4$ Si)  $\delta$  0.85-0.90 (m, 3H), 1.86-1.93 (m, 1H), 2.29-2.36 (m, 1H), 7.17-7.20 (m, 2H), 7.28-7.46 (m, 7H), 7.91 (s, 1H, NH), 8.47 (s, 1H, NH);  $^{13}\text{C}$  NMR (75 MHz, DMSO- $d_6$ ; Me $_4$ Si)  $\delta$  8.0, 27.7, 66.0, 97.3, 115.0, 125.9, 127.9, 128.4, 129.4, 129.5, 135.6, 135.7, 137.0, 166.1, 180.7; Anal. Calcd for C $_{19}$ H $_{16}$ ClN $_3$ S: C, 64.49; H, 4.56; N, 11.87%. Found: C, 64.50; H, 4.57; N, 11.89%.

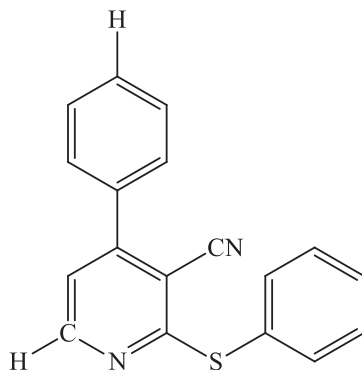


**2-Amino-3-benzyl-3-phenyl-5-(phenylthio)-3H-pyrrole-4-carbonitrile** (2.2.1y, Table 2.2.2, entry 25): Yield (309 mg, 81%); Cream colored solid; mp 184–186 °C (EtOAc/ DCM); IR (KBr) 3410, 3404, 3333, 3242, 3100, 2201, 1625, 1569, 1540, 1440, 1154, 690  $\text{cm}^{-1}$ ;  $^1\text{H}$  NMR (300 MHz, DMSO- $d_6$ ; Me $_4$ Si)  $\delta$  3.53 (s, 2H), 6.92-6.95 (m, 2H), 7.21-7.29 (m, 5H), 7.31-7.39 (m, 6H), 7.43-7.47 (m, 2H), 8.11 (s, 1H, NH), 8.60 (s, 1H, NH);  $^{13}\text{C}$  NMR (75 MHz, DMSO- $d_6$ ; Me $_4$ Si)  $\delta$  39.1, 65.8, 97.0, 116.5, 126.2, 126.9, 127.7, 127.9, 128.2, 129.0, 129.6, 129.9, 132.6, 135.3, 138.7, 166.8, 180.5; Anal. Calcd for C $_{24}$ H $_{19}$ N $_3$ S: C, 75.56; H, 5.02; N, 11.01%. Found: C, 75.58; H, 5.03; N, 11.03%.

### 2.4.2.3 Characteristic data of the synthesized pyridines

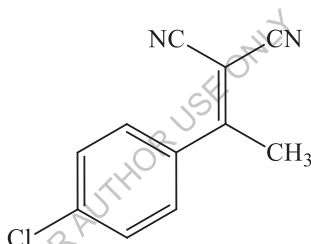


**4-(4-chlorophenyl)-2-(phenylthio)pyridine-3-carbonitrile** (2.2.4a, Table 2.2.3, entry 1): Yield (258 mg, 80%); Yellow solid; mp 210–212 °C (EtOAc/ DCM); IR (KBr) 2216, 1628, 1544, 1487, 1259, 1091, 839, 791  $\text{cm}^{-1}$ ;  $^1\text{H}$  NMR (300 MHz,  $\text{CDCl}_3$ ;  $\text{Me}_4\text{Si}$ )  $\delta$  7.00 (d,  $J=6.3$  Hz, 1H), 7.27-7.28 (m, 1H), 7.39-7.42 (m, 3H), 7.45-7.49 (m, 3H), 7.51-7.56 (m, 2H), 8.37 (d,  $J=6.3$  Hz, 1H);  $^{13}\text{C}$  NMR (75 MHz,  $\text{CDCl}_3$ ;  $\text{Me}_4\text{Si}$ )  $\delta$  105.1, 115.1, 119.8, 128.4, 128.9, 129.4, 129.7, 129.74, 134.1, 135.5, 136.7, 151.9, 152.8, 156.0, 156.04; Anal. Calcd for  $\text{C}_{18}\text{H}_{11}\text{ClN}_2\text{S}$ : C, 66.97; H, 3.43; N, 8.68%. Found: C, 66.99; H, 3.44; N, 8.69%.



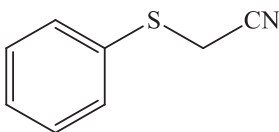
**4-phenyl-2-(phenylthio)pyridine-3-carbonitrile** (2.2.4b, Table 2.2.3, entry 2): Yield (201 mg, 70%); Yellow solid; mp 204–206 °C (EtOAc/ DCM); IR (KBr) 2210, 1617, 1512, 1257, 1064, 722  $\text{cm}^{-1}$ ;  $^1\text{H}$  NMR (300 MHz,  $\text{CDCl}_3$ ;  $\text{Me}_4\text{Si}$ )  $\delta$  7.31 (d,  $J=7.5$  Hz, 1H), 7.54-7.55 (m, 3H), 7.65-7.67 (m, 5H), 7.80-7.82 (m, 2H), 8.96 (d,  $J=7.5$  Hz, 1H);  $^{13}\text{C}$  NMR (75 MHz,  $\text{CDCl}_3$ ;  $\text{Me}_4\text{Si}$ )  $\delta$  100.6, 113.7, 117.2, 128.5, 128.8, 129.2, 129.4, 130.9, 131.4, 134.8, 138.0, 151.1, 151.9, 155.2, 156.6, 158.6; Anal. Calcd for  $\text{C}_{18}\text{H}_{12}\text{N}_2\text{S}$ : C, 74.97; H, 4.19; N, 9.71%. Found: C, 74.99; H, 4.19; N, 9.74%.

#### 2.4.2.4 Characteristic data of intermediate A



**2-[1-(4-Chloro-phenyl)-ethylidene]-malononitrile** (Intermediate A, Scheme 2.2.3): Light yellow solid; mp 79-81 °C (recrystallized from EtOAc/ DCM); IR (KBr) 2225, 1580, 1487, 1403, 1301, 1094, 1010, 838, 717, 478  $\text{cm}^{-1}$ ;  $^1\text{H}$  NMR (300 MHz,  $\text{CDCl}_3$ ;  $\text{Me}_4\text{Si}$ )  $\delta$  2.63 (s, 3H), 7.50 (s, 4H);  $^{13}\text{C}$  NMR (75 MHz,  $\text{CDCl}_3$ ;  $\text{Me}_4\text{Si}$ )  $\delta$  24.1, 85.1, 112.4, 112.5, 128.7, 129.4, 134.1, 138.6, 162.2, 173.8; Anal. Calcd for  $\text{C}_{11}\text{H}_7\text{ClN}_2$ : C, 65.20; H, 3.48; N, 13.82%. Found: C, 65.31; H, 3.50; N, 13.91%.

### 2.4.2.5 Characteristic data of D



**2-(phenylthio)acetonitrile** (Compound D, Scheme 2.2.3): Colorless Liquid; IR (KBr) 3095,2965, 2900, 2255  $\text{cm}^{-1}$ ;  $^1\text{H}$  NMR (300 MHz,  $\text{CDCl}_3$ ;  $\text{Me}_4\text{Si}$ )  $\delta$  3.53 (s, 2H), 7.23-7.25 (m, 3H), 7.38-7.40 (m, 2H);  $^{13}\text{C}$  NMR (75 MHz,  $\text{CDCl}_3$ ;  $\text{Me}_4\text{Si}$ )  $\delta$  20.5, 117.8, 128.3, 129.0, 129.7, 133.9; Anal. Calcd for  $\text{C}_8\text{H}_7\text{NS}$ : C, 64.39; H, 4.73; N, 9.39%. Found: C, 64.40; H, 4.76; N, 9.42%.

### 2.5 References

1. (a) A. R. Katritzky and J. M. Lagowski, *The Principles of Heterocyclic Chemistry*, Academic Press, New York, 1968. (b) M. P. Sammes and A. R. Katritzky, *Adv. Heterocycl. Chem.*, 1982, 32, 233. (c) B. A. Trofimov and A. I. Mikhaleva, *Heterocycles*, 1994, 37, 1193.
2. (a) G. Cirrincione, A. M. Almerico, G. Dattolo, E. Aiello, S. Grimaudo, P. Diana and F. Misuraca, *Farmaco*, 1992, 47, 1555. (b) G. Cirrincione, A. M. Almerico, S. Grimaudo, P. Diana, F. Misuraca, P. Barraja and F. Misuraca, *Farmaco*, 1996, 51, 49.
3. M. Balasubramanian, J. G. Keay, A. R. Katritzky, C. W. Rees and E. V. F. Scriven, *Comprehensive Heterocyclic Chemistry II*, vol. 5, Pergamon Press, London, 1996, 245.
4. X. Lu and S. Lin, *J. Org. Chem.*, 2005, 70, 9651.
5. T. Prueksaritanont, R. M. Freidinger, D. J. Pettibone and M. G. Bock, *J. Med. Chem.*, 2004, 47, 6439.
6. R. K. R. Jetti, A. Nagia, F. Xue and T. C. W. Mark, *Chem. Commun.*, 2001, 919.
7. B. Y. Kim, J. B. Ahn, H. W. Lee, S. K. Kang, J. H. Lee, J. S. Shin, S.

- K. Ahn, C. I. Hong and S. S. Yoon, *Eur. J. Med. Chem.*, 2004, 39, 433.
8. S. Schann, V. Bruban, K. Pompermayer, J. Feldman, B. Pfeiffer, P. Renard, E. Scalbert, P. Bousquet and J. -D. Ehrhardt, *J. Med. Chem.*, 2001, 44, 1588.
9. P. -K. Ch-iu and H. P. Sammes, *Tetrahedron*, 1990, 46, 3439.
10. X. Xu and Y. Zhang, *J. Chem. Soc., Perkin Trans. 1*, 2001, 2836.
11. V. Roubaud, A. Mercier, G. Olive, F. Le Moigne and P. Tordo, *J. Chem. Soc., Perkin Trans. 2*, 1997, 1827.
12. P. A. Koutentis, C. W. Rees, A. J. P. White and D. J. Williams, *J. Chem. Soc., Perkin Trans. 1*, 1998, 2765.
13. M. Adib, H. Tahermansouri, S. A. Koloogani, B. Mohammadiand and H. R. Bijanzadeh, *Tetrahedron Lett.*, 2006, 47, 5957.
14. S. Tu, T. Li, F. Shi, F. Fang, S. Zhu, X. Wei and Z. Zong, *Chem. Lett.*, 2005, 34, 732.
15. G. W. V. Cave and C. L. Raston, *Chem. Commun.*, 2000, 2199.
16. S. Ray, M. Brown, A. Bhaumik, A. Dutta and C. Mukhopadhyay, *Green Chem.*, 2013, 15, 1910.
17. K. Bahrami, M. M. Khodaei, F. Naali, B. H. Yousefi, *Tetrahedron Lett.*, 2013, 54, 5293.
18. P. V. Shinde, S. S. Sonar, B. B. Shingate and M. S. Shingare, *Tetrahedron Lett.*, 2010, 51, 1309.
19. (a) S. Bertelsen and K. A. Jørgensen, *Chem. Soc. Rev.*, 2009, 38, 2178. (b) M. Khoobi, L. Ma'mani, F. Rezazadeh, Z. Zareie, A. Foroumadi, A. Ramazani and A. Shafiee, *J. Mol. Catal. A: Chem.*, 2012, 359, 74.
20. (a) B. List, *Chem. Rev.*, 2007, 107, 5413. (b) M. Benaglia, A. Puglisi and F. Cozzi, *Chem. Rev.*, 2003, 103, 3401. (c) V. List and C. Bolm, *Adv. Synth. Catal.*, 2004, 346, 1007. (d) A. Dondoni and A. Massi, *Angew. Chem.*,

- Int. Ed., 2008, 47, 4638. (e) B. List, Synlett, 2001, 1675. (f) B. List, Tetrahedron, 2002, 58, 5573. (g) P. I. Dalko and L. Moisan, Angew. Chem., Int. Ed., 2004, 43, 5138. (h) D. Enders, C. Grondal and M. R. M. Huttl, Angew. Chem., Int. Ed., 2007, 46, 1570. (i) M. Gruttadauria, F. Giacalone and R. Noto, Adv. Synth. Catal., 2009, 351, 33.
21. (a) B. Fubini and L. O. Arean, Chem. Soc. Rev., 1999, 28, 373. (b) R. Noyori, Chem. Soc. Rev., 1989, 18, 187. (c) S. G. Davies, Organotransition Metal Chemistry Applications to Organic Synthesis, Pergamon, Oxford, 1982.
22. M. Raj and V. K. Singh Chem. Comm., 2009, 6687.
23. (a) K. Maruoka, B. List, H. Yamamoto and L. Z. Gong, Chem. Comm., 2012, 48, 10703.
- (b) C. Mukhopadhyay and S. Ray, Tetrahedron Lett., 2011, 52, 6431. (c) S. Ray and C. Mukhopadhyay, Tetrahedron Lett., 2013, 54, 5078.
24. C. Mukhopadhyay and S. Ray, Tetrahedron, 2011, 67, 7936.
25. (a) F. Bigi, L. Chesini, R. Maggi and G. Sartori, J. Org. Chem., 1999, 1033. (b) C. Mukhopadhyay and S. Ray, Catal. Commun., 2011, 12, 1496.

FOR AUTHOR USE ONLY

**More  
Books!**



yes  
**I want morebooks!**

Buy your books fast and straightforward online - at one of world's fastest growing online book stores! Environmentally sound due to Print-on-Demand technologies.

Buy your books online at  
**[www.morebooks.shop](http://www.morebooks.shop)**

Kaufen Sie Ihre Bücher schnell und unkompliziert online – auf einer der am schnellsten wachsenden Buchhandelsplattformen weltweit! Dank Print-On-Demand umwelt- und ressourcenschonend produziert.

Bücher schneller online kaufen  
**[www.morebooks.shop](http://www.morebooks.shop)**

KS OmniScriptum Publishing  
Brivibas gatve 197  
LV-1039 Riga, Latvia  
Telefax: +371 686 20455

[info@omniscryptum.com](mailto:info@omniscryptum.com)  
[www.omniscryptum.com](http://www.omniscryptum.com)

OMNIscriptum





FOR AUTHOR USE ONLY

# CLIMATE CHANGE AND AGRICULTURE

*Volume - 7*

**Chief Editor**

**Prof. Saket Kushwaha**

Vice Chancellor, Rajiv Gandhi University, Itanagar, Arunachal Pradesh,  
India

**Co-Editor**

**Dr. Virendra Kamalvanshi**

Assistant Professor, Department of Agricultural Economics, Banaras Hindu  
University, Varanasi, Uttar Pradesh, India

Indexing and Abstracting in Following Databases

1. Bowker: A ProQuest Affiliate

**Bowker.**  
a ProQuest affiliate

2. Crossref

  
**Crossref**

Peer Reviewed & Refereed

# CLIMATE CHANGE AND AGRICULTURE

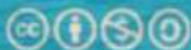
*Volume - 7*

Chief Editor  
Prof. Saket Kushwaha

Co-editor  
Dr. Virendra Kamalvanshi



Published by  
AkiNik Publications,  
169, C-11, Sector - 3, Rohini,  
Delhi - 110085, India  
Toll Free (India): 18001234970  
Email: [akinikbooks@gmail.com](mailto:akinikbooks@gmail.com)



Attribution-NonCommercial-ShareAlike  
4.0 International (CC BY-NC-SA 4.0)



AkiNik Publications  
New Delhi

## Contents

Chapters	Page No.
1. Study of Recent Facts & Findings in Regards to Climate Change Impact and Challenge over the Agriculture: A Review <i>(C.S. Dagar, Anil Kumar, Surender Singh, Anurag and M.L. Khichar)</i>	01-16
2. Climate Change and Agriculture: Causes, Impact and Adaptations <i>(Devilal Birla, Devendra Singh, Suwa Lal Yadav, Manish Yadav, Lakshman and Subhra Sahoo)</i>	17-36
3. Impact of Climate Change on Agricultural Sector <i>(Sahil Boora, Rohit and Mohit)</i>	37-48
4. Impact of Climate Change on Crop Production <i>(Kshetrimayum Manishwari Devi and Tabuiliu Abonmai)</i>	49-63
5. Global Dimming: A Shadow over Earth <i>(Dr. Rajashree Khatua)</i>	65-81
6. Plastic Waste: It's Impact of Agricultural and on Environment <i>(Devendra Pratap Singh, Diksha Tiwari, Alok Kumar Singh and Shraddha Singh)</i>	83-100
7. Climate Change on Quality Seed Production: Challenges and Strategies <i>(Niranjan Prasad HP, Ramappa S, Shreenath YS and Prashanth ST)</i>	101-113
8. Climate Change on Agriculture: A Systematic Review of the Impact in the Major Agricultural Regions in the Indian Context <i>(Ananya Srinivas and Dr. Pooja R.)</i>	115-125

# Chapter - 8

## Climate Change on Agriculture: A Systematic Review of the Impact in the Major Agricultural Regions in the Indian Context

Ananya Srinivas and Dr. Poosja R.

### Abstract

Climate change is causing a rapid rise in global temperatures, which has a significant impact on agricultural methods. The weather's extreme depressions and erratic rains make it difficult for farmers to make a living. The purpose of the paper is to synthesise data from numerous studies on Indian agriculture and climate with a basic analysis of historical studies that detail the mitigation strategies of past climate changes and extremes, the types of adjustments that have taken place, and the susceptibility of Indian agriculture to climate change. Over a million farmers rely on farming as their primary source of income, and the negative effects of climate change result in crop loss and energy expenditure losses. This review paper will help agronomists, economists, and policymakers to take preventative and adaptive measures to better navigate future disasters. A systematic review has been conducted to understand the ancient and modern practices in agricultural predictions and the management practices undertaken to provide recommendations for their implementation.

**Keywords:** Agriculture, climate change, India, temperature, precipitation.

### Introduction

**Climate change:** Due to the Earth's rotation around the sun, climate change is a naturally occurring phenomenon which causes changes in earth's ecosystem and the time duration is one that manifests over thousands of years. However, the progression of these timescales is due to the many anthropological activities such as the burning of fossil fuels which lead to rise in greenhouse gasses (0.9C since 19<sup>th</sup> century) such as oxides of carbon and methane from petroleum fuels combustion (Godgil 1995 ;Stern and Kaufman, 2013): climate change greatly impacts biodiversity and agriculture by a rise in the sea level (97mm, 2021) which incurs due to the melting of glaciers that

## ABOUT THE EDITORS



**Dr. M.Z.A. Khan**

**Dr. M.Z.A. Khan** obtained his M.A. (1984), M.Phil. (1986) and Ph.D. (1990) in Geography from M.L. Sukhadia University, Udaipur (Rajasthan). He has been awarded with Gold Medals (M.A. & M.Phil.) and UGC-NET. At present Dr. Khan is working as Senior Associate Professor in Geography at P.G. Department of Geography, Government Arts College, Kota (Raj.), Convener, Board of Studies in Geography since 2010 at University of Kota, Kota. Dr. Khan is engaged in research and teaching for more than three decades. He has published a number of Research Papers/Articles in various journals, proceedings and edited books. He has actively participated in many National and International Seminars/Conferences pertaining to the subject. He has successfully convened a UGC sponsored National Seminar and completed UGC sponsored Major Research Projects and Minor Research Projects. Dr. Khan has also been supervising research work leading to the award of the Ph.D. degree in Geography. 31 M.Phil. Dissertations, 6 M.A. Dissertations and 17 Research students have been awarded Ph.D. under the supervision of Dr. Khan. He has been serving on the Boards of Studies and Boards of Examiners of several Universities.



**Dr. Sunil Kumar Verma**

Born on May 18, 1982 in Kurbara, Neem Ka Thana, Rajasthan, India, Dr. Sunil Kumar Verma, M.A. (Geography) M.Sc. (RS & GIS), CSIR and UGC NET / JRF, SET, Ph.D., is an active and dynamic researcher and Ph.D. Supervisor who is currently working as a Lecturer (PGT) in Department of Geography, JNV, Longding, Arunachal Pradesh, India. In Oct. 2011, University of Kota, Kota awarded him Ph.D. He has been teaching Geography for the last 13 years and has devotedly worked at several reputed colleges located at Sikar, Churu and Sri Ganganagar. He has also published 11 books and more than 35 research papers and articles in national and international peer-reviewed multi-disciplinary research journals. He has also attended 34 National and 21 International Seminars and Conferences. He is also a life member of NAGI and RGA.

**VL Media Solutions**  
[www.vlmspublications.com](http://www.vlmspublications.com)

ISBN: 978-93-91308-29-2



9 789391 308292

# Contents

---

Sr	Title & Author	Pg
1	<b>A Comparative Assessment of Quality of Irrigation Water around Ranchi District of Jharkhand, India</b> <i>Asisan Minz, Rema Das</i>	1
2	<b>Coastal Sands Textural Analysis from Ramakrishna Beach-Bhimunipatnam Tract (Visakhapatnam) East Coast of India</b> <i>B. Suvarna, V. Sunitha, Y. Sudharshan Reddy</i>	21
3	<b>The Nature of Household's Pollution Sources in Indian Cities at the Present Scenario</b> <i>Dr. Gopal Sonkar</i>	34
4	<b>Perception Toward the Eco-Friendly Packaging</b> <i>Dr. Kirti Kesarwani, Dr. Aditi Vats, Dr. Sandhya Rani, Dr. Priyanka Kesarwani</i>	45
5	<b>Assessment of the Effect of Industrial effluent on germination and growth of Phaseolus mungo L.</b> <i>Dr. Malini Shetty A.G, Prof. Somashekar R.K.</i>	53
6	<b>Evolution, Characteristics and Utilisation of Wetlands in the Southern Part of Nadia District, West Bengal</b> <i>Dr. Mitrajit Chatterjee</i>	69
7	<b>Study on New and Innovative Marketing Strategies of Small and Medium Enterprises</b> <i>Dr. Pulidindi Venugopal, Dr. S. Anjani Devi, S. Aswini Priya, Yuvaraj, D., Shaply Abdul Kareem</i>	95
8	<b>A Scenario of Overpopulation in India: Its Causes, Effects and Solutions</b> <i>Dr. R. Suresh Verma, Ms. K. Gowthami, Ms. S.R. Baby Rhodes</i>	113

# Research Highlights in Agricultural Sciences

Vol. 6

India • United Kingdom



B P International



## Editor(s)

**Dr. Rusu Teodor**

Professor,  
Department of Technical and Soil Sciences, University of Agricultural  
Sciences and Veterinary Medicine Cluj-Napoca, 3-5 Manastur Street,  
400372, Cluj-Napoca, Romania.  
Email: rusuteodor23@yahoo.com, rusuteodor23@yahoo.com,  
trusu@usamvcluj.ro;

**FIRST EDITION 2022**

**ISBN 978-93-5547-979-2 (Print)**

**ISBN 978-93-5547-980-8 (eBook)**

**DOI: 10.9734/bpi/rhas/v6**



## Contents

---

Preface	i
Chapter 1 Water Management Trajectory: Evidence from Smallholder Farmers in Mpumalanga Province, South Africa Agholor, Azikiwe Isaac	1-13
Chapter 2 Functionality of Smallholder Scheme and Evaluation of Decisions: Evidence from Zanyokwe Irrigation Scheme in Eastern Cape, South Africa Agholor Azikiwe Isaac	14-26
Chapter 3 A Review on Rice Lanraces of Manipur (India) Subhalakshmi Shijagurumayum, G. A. Shantibala Devi and Ch. Brajakishor Singh	27-35
Chapter 4 Industrial Effluent and Its Effect on Germination and Seedling Growth of <i>Phaseolus aureus</i> Roxb and <i>Phaseolus mungo</i> L. A. G. Malini Shetty	36-44
Chapter 5 Field Evaluation of Certain Chemicals and Biopesticides against Pod Borer, <i>Helicoverpa armigera</i> (Hubner) in Chickpea: An Experimental Research Prajakta Anil Mohite and Shaik Ahmed Razack Khan	45-54
Chapter 6 Knowledge and Utilization of Information and Communication Technology (ICT) Projects among the Farmers: A Case Study from Karnataka, India R. Vishwatej, J. G. Angadi and Saikat Maji	55-63
Chapter 7 Smart Farming: Future of Agriculture T. Geetha Jebarathnam Kuttibai, M. S. Bhagavathi and V. Prakash	64-72
Chapter 8 Utilization of Polysaccharides Extracted from Tofu Processing Wastewater for Microencapsulation Processes in the Food Industry: Experimental Investigation T. S. Sonda, Memuna K. Sawi, Abigail Nyamawa and M. S. Sonda	73-83
Chapter 9 Combination of Mutation Induction and <i>In vitro</i> Selection Methods for Assembling Salinity Stress Tolerant Varieties Rossa Yunita	84-93

---

---

## Industrial Effluent and Its Effect on Germination and Seedling Growth of *Phaseolus aureus* Roxb and *Phaseolus mungo* L.

A. G. Malini Shetty <sup>a#</sup>

DOI: 10.9734/bpi/rhas/v6/3869B

---

### ABSTRACT

Industrial effluents are the second major source of water pollution and are making the water unfit for both agriculture and domestic use. But these effluents with proper dilution can be used as source of fertilizer in agriculture. In the present investigation, the treated effluent from BHEL was first analyzed for 13 physico-chemical parameters. Seed germination and seedling growth study of *Phaseolus aureus* and *Phaseolus mungo* was conducted in the second stage using different concentrations of [10, 25, 50, 75, 100 %] effluent. The percentage germination, shoot and root length, Vigour Index, Relative Toxicity were measured in all these treatments. The biochemical parameters like Protein, Proline, Carbohydrates and Phenol were assessed in plants in all these treatments. The morphological parameters showed increase in 10 and 25% concentration of effluent. The higher concentration had inhibitory effect on all morphological parameters. Vigour Index of the seedling showed decrease in higher concentration of treatment, while relative toxicity exhibited increase with increase in concentration of treatment. Among biochemical parameters protein revealed higher concentration in 10 and 25% treated plants. Other biochemical parameters showed higher values in 75 to 100% concentration. Bangalore being land locked city faces severe water scarcity, reuse of these effluents in agriculture is the best solution to mitigate this problem.

*Keywords:* Industrial effluents; Germination; *P. aureus*; *P. mungo*; Shoot length; Root length; Biochemical parameters.

### 1. INTRODUCTION

Man was living in coherence with nature since the beginning of human civilization. But the industrial revolution of the eighteenth century followed by the

---

<sup>#</sup> Associate Professor;

<sup>a</sup> Department of Botany, Surana College, Bangalore-4, India.

\*Corresponding author. E-mail: malashettya@yahoo.com.

urbanization and rapid increase in population has led to haphazard growth of cities, putting pressure on the natural resources of the area, causing pollution of air, water and soil. Water an important natural resources is hugely exploited by the industries and are releasing waste water which is causing the serious pollution problems in some parts of the world. Industrial effluents cause serious water and soil pollution and also affect crop productivity [1].

In the modern world Industries are indispensable for economic development of any country, but it should not be at the expense of its natural resources. Effluents from industries are both problem and resource as it contains important nutrients which can be utilized as source of fertilizer in agriculture [2-4]. Recycle and reuse of these effluent is one of the best solution, which is being envisaged by scientists all around the world. Singh and Mishra [5] in their studies have shown that the effluents can be used as a source of fertilizer and its application in agriculture helps in removal of nutrients and provides for primary, secondary and tertiary treatment.

India being the main agriculture country, water scarcity is a huge problem, which can be compensated by these effluents which at lower concentration not only helps to attenuate the water problem but also helps in recycling of these effluents without causing much toxic effects on soil or crops. The increasing agricultural reuse of treated effluent helps in promoting sustainable agriculture, preserving scare water resources, and maintaining environmental quality [6].

Electroplating industries in India release a huge amount of effluents contains high COD and BOD besides heavy metals like Co, Ni, Zn and Hg which is toxic to plants, animals and leads to bio-magnification. In this regard, the present study was taken up to characterize the treated effluent of BHEL and its effect on germination and seedling growth of *Phaseolus mungo* and *Phaseolus aureus*.

## 2. MATERIALS AND METHODS

In the current investigation the treated effluent of Bharat Heavy Electrical Ltd was collected and analysed for thirteen Physico chemical parameters using standard methods [7]. The effluents was then made in to different concentration ranging from 10, 25, 50 ,75% and 100% using distilled water and its effect on germination, seedling growth and biochemical Parameters of *Phaseolus mungo* and *Phaseolus aureus* was studied with control containing distilled water for reference.

The germination study was conducted using petriplate method. The seeds of *Phaseolus mungo* and *Phaseolus aureus* were treated with 0.1% Mercuric chloride as disinfectant for 10 min, then were soaked in different concentration of effluent and control for 3 hrs and transferred to sterilized petriplates containing moistened filter paper. A total of 100 seeds were used and four replicates were maintained for each expt. The Petri dishes were incubated at room temperature under diffused light. 5 ml of respective dilutions were sprayed on alternate days. Germination counts were made after 48 hrs. The shoot and root lengths were

measured every alternate days for ten days [8]. The Germination percentage, Root and shoot length and the Vigour Index [9] was calculated after the completion of the experiment. Relative toxicity (% R.T.) of effluent on the germination and seedling growth were calculated to determine the degree of inhibition over control [10].

### 2.1 Biochemical Analysis

Biochemical Analysis is carried out to estimate Proteins [11], Proline [12], Phenol [13] and carbohydrates [14].

### 3. RESULTS AND DISCUSSION

The effluent of BHEL was neutral and contained 2715 mg/l of total solids. The turbidity ranged between 8 and 18 NTU. The sample recorded BOD and COD in the range of 200-218 mg/l and 144-620 mg/l respectively. Among the heavy metals analysed, concentration of zinc was found in higher level followed by copper, nickel, chromium and lead.

**Table 1. Physico –chemical parameters of effluent water**

S. no.	Parameters	Values (mg/l)
1	pH	7.8
2	Turbidity	18
3	Total Dissolved Solids	3160
4	Total Suspended Solids	2260
5	Alkalinity	640
6	BOD	218
7	COD	620
8	Ammonical Nitrogen	10.00
9	Zinc	1.12
10	Copper	1.20
11	Nickel	1.10
12	Lead	0.17
13	Chromium	0.42

The percentage of germination, shoot and root length were significantly ( $P \leq 0.05$ ) influenced beyond 50% treatment. However 10 and 25% effluent exerted positive influence on germination percentage, shoot and root length of the seedlings. A dose dependent relationship was observed in both the plants. Barua and Das [15] observed similar effects when they treated *Oryza* seeds with Paper mill effluent.

Seed germination percentage in both tested crops gradually decreased with increasing concentration of effluent (Table 2). Seedling treated with 75% and 100% concentration of effluent indicated maximum reduction in germination Percentage. Kumar et al. [16] and Ramya et al. (2017) noted similar reduction in germination of seeds in their studies. The reduction in germination and seedling

growth at higher concentration is perhaps due to higher level of heavy metals and total dissolved solids, enriching salinity of the effluent interfered with seed absorption before germination.

**Table 2. Impact of factory effluent on germination, root and shoot parameters in crop**

***Phaseolus aureus***

S.No	Concentrations	Germination %	Root length	Shoot length	Vigour index
1	Control	99.00	3.48	4.53	792.99
	Std Dev	0.00	0.38	0.32	
2	10	95.00	3.93	4.88	836.95
	Std Dev	0.00	0.39	0.80	
3	25	96.00	4.33	5.45	938.88
	Std Dev	2.50	0.68	0.39	
4	50	94.00	3.35	4.30	719.10
	Std Dev	2.50	0.63	0.32	
5	75	90.00	3.00	4.40	666.00
	Std Dev	2.50	0.60	0.29	
6	100	88.00	1.80	2.95	418.00
	Std Dev	0.00	0.62	0.83	

***Phaseolus mungo***

S. no	Concentrations	Germination %	Root length	Shoot length	Vigour index
1	Control	92.00	3.65	4.62	760.84
	Std Dev	10.00	0.91	0.83	
2	10	90.00	4.10	4.62	784.80
	Std Dev	4.79	0.28	0.82	
3	25	91.00	3.95	4.93	808.96
	Std Dev	4.79	0.36	0.8	
4	50	72.50	2.45	2.50	358.90
	Std Dev	9.57	0.09	0.81	
5	75	75.00	1.83	1.75	268.50
	Std Dev	10.00	0.62	0.24	
6	100	75.00	1.35	1.78	234.80
	Std Dev	10.00	0.34	0.49	

Germination and seedling growth was maximum in 25% diluted effluent than the control while undiluted effluent showed inhibitory effects. Hussain et al. [17] also reported that diluted effluent (25%) increase the growth parameters and pigments in the Maize seedlings. Kaushik et al. [18] observed maximum germination and higher seedling growth at 20% concentration of effluent. The increase in germination percentage at lower concentration indicates stimulation

of physiologically inactive seeds by effluent treatment [19]. Seedling at lower concentration of treatment showed higher percentage of survival.

Seed vigor is an important quality parameter which needs to be assessed to supplement germination and viability tests to gain insight into the performance of a seed lot in the field or in storage [20]. The Vigour Index of both *P. aureus* and *P. mungo* seedlings were significantly low in undiluted effluent when compared to control. Conversely, at lower concentration both seedlings showed marked increase in vigour index over control. Prathibha and Azra [21] noticed similar findings in *Glycine max* treated with Dyeing factory effluent. There is continuous decrease in Vigour index of the seedlings with increase in concentration of effluent from 50% treatment.

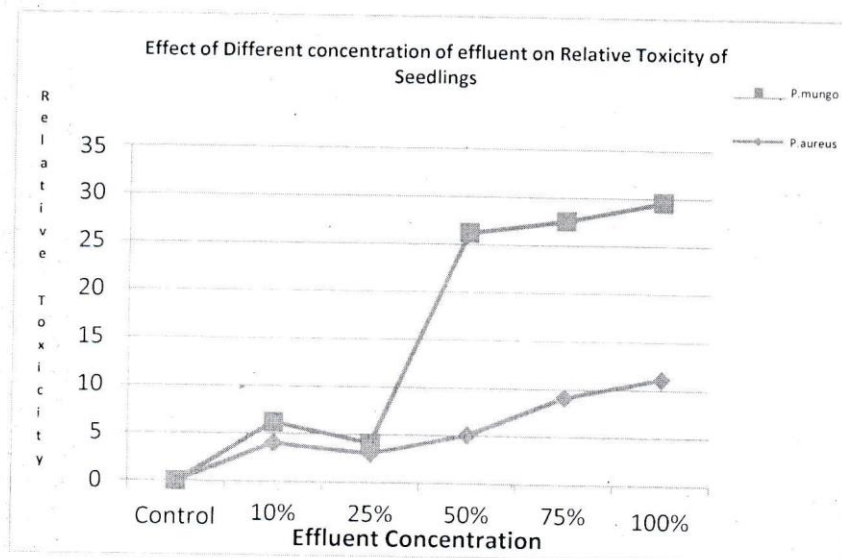


Fig. 1.

The lower concentrations like 10 and 25% effluent had a growth promoting effect on both the seedlings. Chinnusamy, et al. [22] observed the increase in root length, shoot length and vigour index in 25% than 50% over control. The increase in germination percentage and seedling growth at lower concentration may be due to presence of suitable nutrients present at the optimum level in the effluent. However, the excess minerals and nutrients will have inhibitory effect on both the germination and growth by interfering with metabolic activities [23]. Graph (Fig. 1) showed minimum relative toxicity percentage in 25% concentration and maximum in 75 and 100% treatment. Rahman et al. [24] and David et al. [25] made identical observation in Dyeing Industry Effluent.

6. Rana Ibrahim Al-Dulaimi, Norli Bt Ismail, Mahamad Hakimi Ibrahim. The effect Industrial waste water in seed growth rate: A Review, Intl J of Sci and Res Publ. 2012;2(3):1-4.
7. American Public Health Association (APHA-AWWAWPCH). Standard Methods for the Examination of Water and Waste Water. 20th ed. APHA Washington D.C. 1998;1270.
8. Mhatre GN, Chaphekar SB. Effect of heavy metals on seed germination and early growth. J of Env'tl. Biol. 1982;3(2):53-63.
9. Abdul-Baki AS, Anderson JO. Vigour determination in soya bean seed by multiple criteria. Crop Sci. 1973;630-633.
10. Chapagain N. Physiological impact of Dhobikhola (Kathmandu) water pollution of *Persicaria perfoliata* L. leaves and germination of some vegetable seeds. M.Sc. Thesis, Central Department of Botany, Tribhuvan University, Kathmandu. Nepal; 1991.
11. Lowry OH, Rosebrough NJ, Farr AL, Randall RJ. Protein estimation with folin phenol reagent. Journal of Biological Chemistry. 1951;193:265-275.
12. Bates LS, Waldren RF, Teare I. Rapid determination of free proline for water stress conditions. Plant and Soil. 1973;39:205-207.
13. Malick CP, Singh MB. Plant enzymology and histology. Kalyani Publishers, New Delhi; 1980.
14. Sadashivam, Manikkam A. Biochemical methods for agricultural sciences. Willey Eastern Ltd. New Delhi; 1992.
15. Baruah BK, Das M. Effect of paper mill effluent on seed germination of crop plant *Oryza* (ESP) was found to be higher in comparison to initial *sativa* L. Environ. Ecol. 1997;15:904-906.
16. Kumar A, Singh AK, Chandra R. Comparative analysis of residual organic pollutants from bleached and unbleached paper mill wastewater and their toxicity on *Phaseolus aureus* and *Tubifex*. Urban Water Journal. 2020;25;17(10):860-70.
17. Hussain I, Iqbal M, Nawaz M, Rasheed R, Perveen A, Mahmood S, Yasmeen A, Wahid A. Effect of sugar mill effluent on growth and Antioxidative Potential of Maize Seedling. International Journal of Agriculture & Biology. 2013;15(6):1227-1235.
18. Kaushik P, Garg VK, Singh B. Effect of textile effluents on growth performance of wheat cultivars. Bioresour. Technol. 2005;96:1189-1193.
19. Dutta SK, Boissya Cl. Effect of paper mill effluent on growth yield and N, P, K contents of transplanted Rice (*Oryza sativa* L var. Mahsuri). J. Environ. Biol. 1999;20:29-32.
20. Bhupinder Singh, Anoop Yadav. Effect of distillery effluent on different wheat cultivars. World Journal of Environmental Biosciences. 2012;1(1):38-41.
21. Pratibha Mahawar, Azra Akhtar. Impact of dye effluent on seed germination, seedling growth and chlorophyll content of soyabean (*Glycine max* L.). Int. J. Sci. Res. 2019;8(10):1-5.
22. Chinnusamy C, Annadurai K, Jayanthi C, Veeraputhiran R, Karunanthi S. Organic amendments and distillery effluent on soil, fertility and productivity of Rice. Proceedings of National Seminar on Use of Poor Quality Water



6. Rana Ibrahim Al-Dulaimi, Norli Bt Ismail, Mahamad Hakimi Ibrahim. The effect Industrial waste water in seed growth rate:A Review, Intl J of Sci and Res Publ. 2012;2(3):1-4.
7. American Public Health Association (APHA-AWWAWPCH). Standard Methods for the Examination of Water and Waste Water. 20th ed. APHA Washington D.C. 1998;1270.
8. Mhatre GN, Chaphekar SB. Effect of heavy metals on seed germination and early growth. J of Envntl. Biol. 1982;3(2):53-63.
9. Abdul-Baki AS, Anderson JO. Vigour determination in soya bean seed by multiple criteria. Crop Sci. 1973;630-633.
10. Chapagain N. Physiological impact of Dhubikhola (Kathmandu) water pollution of *Persicaria perfoliata* L. leaves and germination of some vegetable seeds. M.Sc. Thesis, Central Department of Botany, TribhuvanUniversity, Kathmandu. Nepal; 1991.
11. Lowry OH, Rosebrough NJ, Farr AL, Randall RJ. Protein estimation with folin phenol reagent. Journal of Biological Chemistry. 1951;193:265-275.
12. Bates LS, Waldren RF, Teare I. Rapid determination of free proline for water stress conditions. Plant and Soil. 1973;39:205-207.
13. Malick CP, Singh MB. Plant enzymology and histology. Kalyani Publishers, New Delhi; 1980.
14. Sadashivam, Manikkam A. Biochemical methods for agricultural sciences. Willey Eaastern Ltd. New Delhi; 1992.
15. Baruah BK, Das M. Effect of paper mill effluent on seed germination of crop plant *Oryza* (ESP) was found to be higher in comparison to initial sativa L. Environ. Ecol. 1997;15:904-906.
16. Kumar A, Singh AK, Chandra R. Comparative analysis of residual organic pollutants from bleached and unbleached paper mill wastewater and their toxicity on *Phaseolus aureus* and *Tubifex*. Urban Water Journal. 2020;25;17(10):860-70.
17. Hussain I, Iqbal M, Nawaz M, Rasheed R, Perveen A, Mahmood S, Yasmeen A, Wahid A. Effect of sugar mill effluent on growth and Antioxidative Potential of Maize Seedling. International Journal of Agriculture & Biology. 2013;15(6):1227-1235.
18. Kaushik P, Garg VK, Singh B. Effect of textile effluents on growth performance of wheat cultivars. Bioresour. Technol. 2005;96:1189-1193.
19. Dutta SK, Boissya CI. Effect of paper mill effluent on growth yield and N, P, K contents of transplanted Rice (*Oryza sativa* L var. Mahsuri). J. Environ. Biol. 1999;20:29-32.
20. Bhupinder Singh, Anoop Yadav. Effect of distillery effluent on different wheat cultivars. World Journal of Environmental Biosciences. 2012;1(1):38-41.
21. Pratibha Mahawar, Azra Akhtar. Impact of dye effluent on seed germination, seedling growth and chlorophyll content of soyabean (*Glycine max* L.). Int. J. Sci. Res. 2019;8(10):1-5.
22. Chinnusamy C, Annadurai K, Jayanthi C, Veeraputhiran R, Karunanthi S. Organic amendments and distillery effluent on soil, fertility and productivity of Rice. Proceedings of National Seminar on Use of Poor Quality Water